



Chipsmall Limited consists of a professional team with an average of over 10 year of expertise in the distribution of electronic components. Based in Hongkong, we have already established firm and mutual-benefit business relationships with customers from,Europe,America and south Asia,supplying obsolete and hard-to-find components to meet their specific needs.

With the principle of “Quality Parts,Customers Priority,Honest Operation,and Considerate Service”,our business mainly focus on the distribution of electronic components. Line cards we deal with include Microchip,ALPS,ROHM,Xilinx,Pulse,ON,Everlight and Freescale. Main products comprise IC,Modules,Potentiometer,IC Socket,Relay,Connector.Our parts cover such applications as commercial,industrial, and automotives areas.

We are looking forward to setting up business relationship with you and hope to provide you with the best service and solution. Let us make a better world for our industry!



Contact us

Tel: +86-755-8981 8866 Fax: +86-755-8427 6832

Email & Skype: info@chipsmall.com Web: www.chipsmall.com

Address: A1208, Overseas Decoration Building, #122 Zhenhua RD., Futian, Shenzhen, China



Voltage Variable Absorptive Attenuator 40 dB, 0.5 - 3.0 GHz

Rev. V2

Features

- Single Positive Voltage Control: 0 to +5 Volts
- 40 dB Attenuation Range at 900 MHz
- ± 2 dB Linearity from BSL
- Low DC Power Consumption
- Tape and Reel Packaging Available
- Lead-Free SOIC-8 Package
- 100% Matte Tin Plating over Copper
- Halogen-Free "Green" Mold Compound
- 260°C Reflow Compatible
- RoHS* Compliant Version of AT-108

Description

M/A-COM's MAAVSS0007 is a GaAs MESFET MMIC voltage variable absorptive attenuator in a lead-free SOIC-8 surface mount plastic package. The MAAVSS0007 is ideally suited for use where linear attenuation, fine tuning and very low power consumption are required.

Typical applications include radio, cellular, GPS equipment and automatic gain/level control circuits.

The MAAVSS0007 is fabricated with a monolithic GaAs MMIC using a mature 1-micron process. The process features full chip passivation for increased performance and reliability.

Ordering Information ^{1,2}

Part Number	Package
MAAVSS0007	Bulk Packaging
MAAVSS0007TR	1000 piece reel
MAAVSS0007SMB	Sample Board

1. Reference Application Note M513 for reel size information.
2. All sample boards include 5 loose parts.

Functional Schematic ^{3,4,5,6}

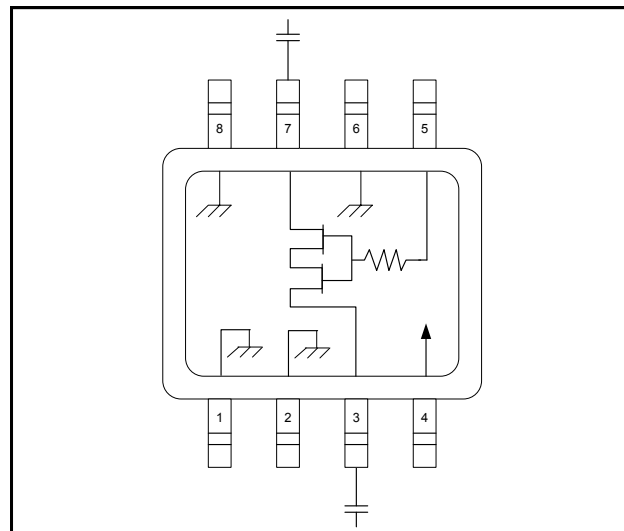

3. $V_{cc} = +5$ VDC @ 50 μ A maximum.
4. $V_c = 0$ VDC to +5 VDC @ 50 μ A maximum.
5. External DC blocking capacitors are requirements on all RF ports.
6. 39 pF used for data measurements.

Pin Configuration

Pin No.	Function	Pin No.	Function
1	Ground	5	V_c
2	Ground	6	Ground
3	RF Port	7	RF Port
4	V_{cc}	8	Ground

Absolute Maximum Ratings ^{7,8}

Parameter	Absolute Maximum
Input Power	+21 dBm
Supply Voltage V_{cc}	$-1 \text{ V} \leq V_{cc} \leq +8 \text{ V}$
Control Voltage V_c	$-1 \text{ V} \leq V_c \leq V_{cc} + 0.5 \text{ V}$
Operating Temperature	-40°C to $+85^\circ\text{C}$
Storage Temperature	-65°C to $+150^\circ\text{C}$

7. Exceeding any one or combination of these limits may cause permanent damage to this device.
8. M/A-COM does not recommend sustained operation near these survivability limits.

* Restrictions on Hazardous Substances, European Union Directive 2002/95/EC.

Voltage Variable Absorptive Attenuator 40 dB, 0.5 - 3.0 GHz

Rev. V2

Electrical Specifications: $T_A = 25^\circ\text{C}$, $Z_0 = 50 \Omega$

Parameter	Test Conditions	Units	Min.	Typ.	Max.
Insertion Loss	0.5 - 1.0 GHz	dB	—	2.5	—
	1.0 - 3.0 GHz	dB	—	2.6	3.5
Attenuation	0.5 - 1.0 GHz	dB	—	43	—
	1.0 - 2.0 GHz	dB	35	40	—
	2.0 - 3.0 GHz	dB	—	33	—
Flatness (peak-to-peak)	0.5 - 1.0 GHz	dB	—	± 0.5	—
	1.0 - 2.0 GHz	dB	—	± 1.2	—
	2.0 - 3.0 GHz	dB	—	± 1.5	—
VSWR	0.5 - 3.0 GHz	Ratio	—	2:1	—
Trise, Tfall	10% to 90% RF, 90% to 10% RF	μS	—	15	—
Ton, Toff	50% Control to 90% RF, 50% Control to 10% RF	μS	—	25	—
Transients	In-Band	mV	—	12	—

Lead-Free SOIC-8[†]

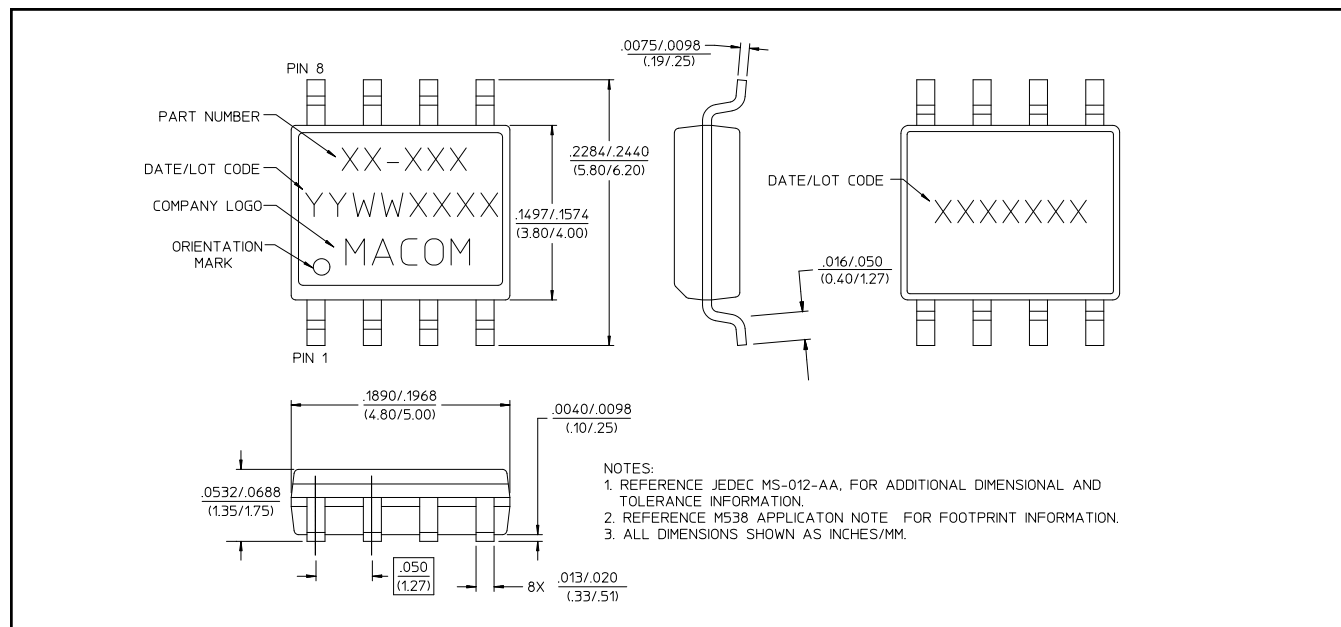

[†] Reference Application Note M538 for lead-free solder reflow recommendations.
Meets JEDEC moisture sensitivity level 1 requirements.

Voltage Variable Absorptive Attenuator 40 dB, 0.5 - 3.0 GHz

Rev. V2

Typical Performance Curves @ 25°C

Attenuation vs. Control Voltage

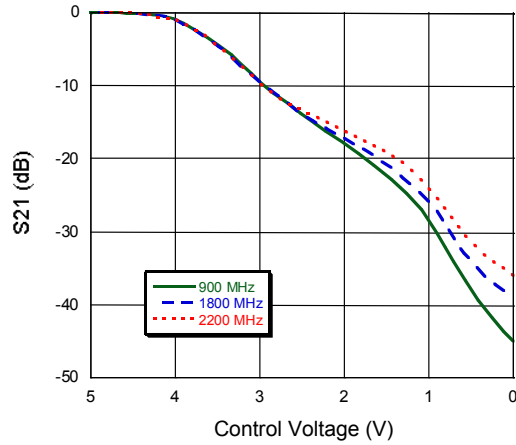

Insertion Loss vs. Frequency

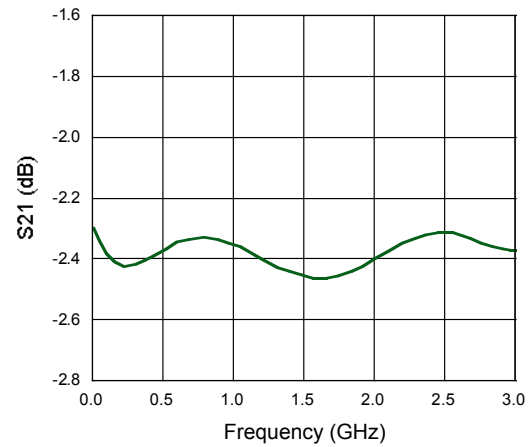

Return Loss vs. Control Voltage, F = 900 MHz

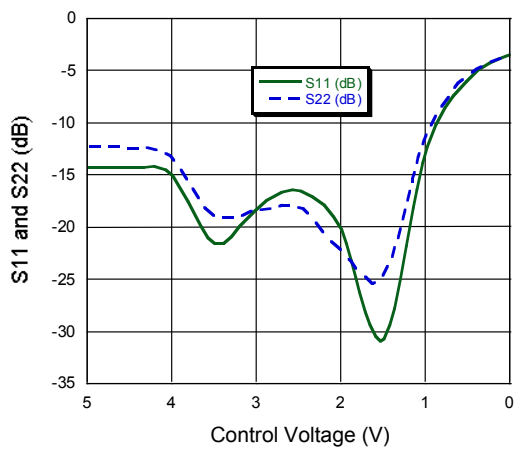

Return Loss vs. Control Voltage, F = 1800 MHz

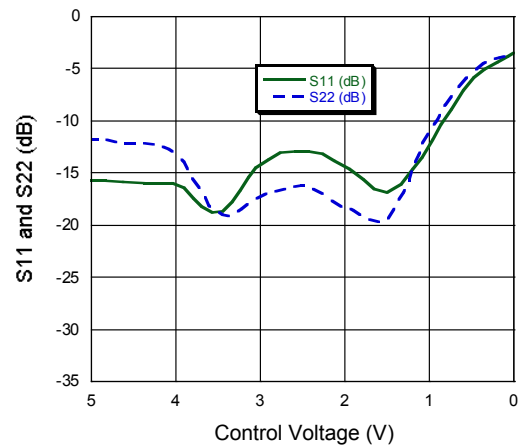

Return Loss vs. Control Voltage, F = 2200 MHz

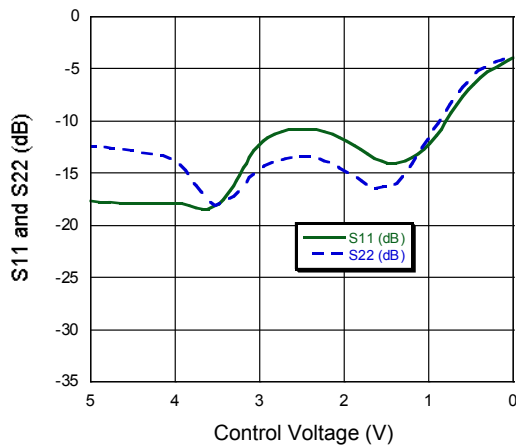

Maximum Attenuation vs. Frequency

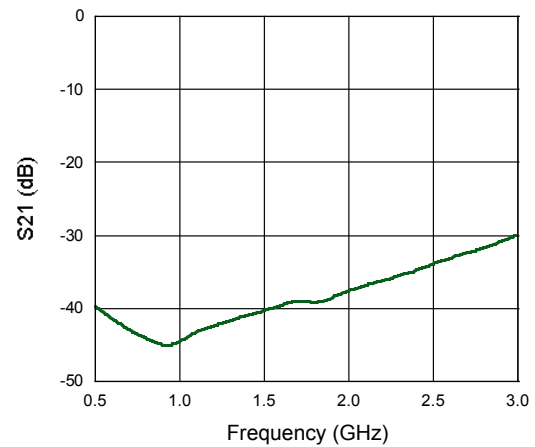

Voltage Variable Absorptive Attenuator 40 dB, 0.5 - 3.0 GHz

Rev. V2

Typical Performance Curves @ 25°C

1 dB Compression vs. Control Voltage, F = 900 MHz

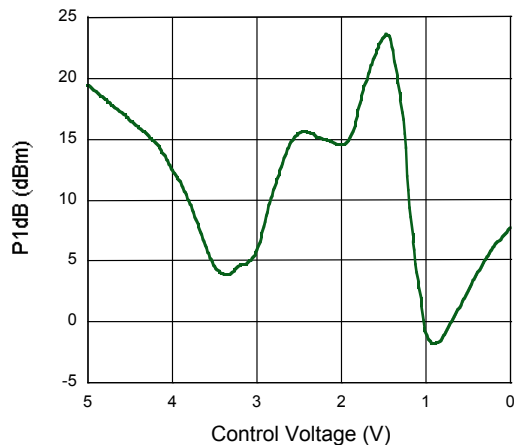

IP3 vs. Control Voltage

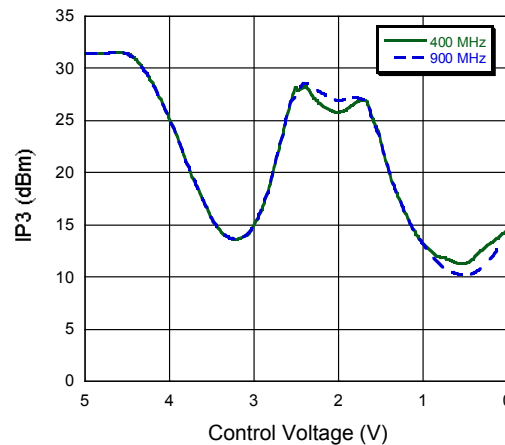

**Attenuation vs. Temperature
Normalized to 25°C, F = 900 MHz**

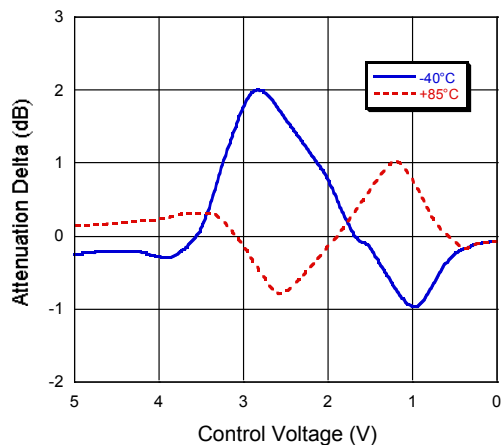

Handling Procedures

Please observe the following precautions to avoid damage:

Static Sensitivity

Gallium Arsenide Integrated Circuits are sensitive to electrostatic discharge (ESD) and can be damaged by static electricity. Proper ESD control techniques should be used when handling these devices.

M/A-COM Technology Solutions Inc. All rights reserved.

Information in this document is provided in connection with M/A-COM Technology Solutions Inc ("MACOM") products. These materials are provided by MACOM as a service to its customers and may be used for informational purposes only. Except as provided in MACOM's Terms and Conditions of Sale for such products or in any separate agreement related to this document, MACOM assumes no liability whatsoever. MACOM assumes no responsibility for errors or omissions in these materials. MACOM may make changes to specifications and product descriptions at any time, without notice. MACOM makes no commitment to update the information and shall have no responsibility whatsoever for conflicts or incompatibilities arising from future changes to its specifications and product descriptions. No license, express or implied, by estoppel or otherwise, to any intellectual property rights is granted by this document.

THESE MATERIALS ARE PROVIDED "AS IS" WITHOUT WARRANTY OF ANY KIND, EITHER EXPRESS OR IMPLIED, RELATING TO SALE AND/OR USE OF MACOM PRODUCTS INCLUDING LIABILITY OR WARRANTIES RELATING TO FITNESS FOR A PARTICULAR PURPOSE, CONSEQUENTIAL OR INCIDENTAL DAMAGES, MERCHANTABILITY, OR INFRINGEMENT OF ANY PATENT, COPYRIGHT OR OTHER INTELLECTUAL PROPERTY RIGHT. MACOM FURTHER DOES NOT WARRANT THE ACCURACY OR COMPLETENESS OF THE INFORMATION, TEXT, GRAPHICS OR OTHER ITEMS CONTAINED WITHIN THESE MATERIALS. MACOM SHALL NOT BE LIABLE FOR ANY SPECIAL, INDIRECT, INCIDENTAL, OR CONSEQUENTIAL DAMAGES, INCLUDING WITHOUT LIMITATION, LOST REVENUES OR LOST PROFITS, WHICH MAY RESULT FROM THE USE OF THESE MATERIALS.

MACOM products are not intended for use in medical, lifesaving or life sustaining applications. MACOM customers using or selling MACOM products for use in such applications do so at their own risk and agree to fully indemnify MACOM for any damages resulting from such improper use or sale.

5

M/A-COM Technology Solutions Inc. (MACOM) and its affiliates reserve the right to make changes to the product(s) or information contained herein without notice.
Visit www.macom.com for additional data sheets and product information.