



Chipsmall Limited consists of a professional team with an average of over 10 year of expertise in the distribution of electronic components. Based in Hongkong, we have already established firm and mutual-benefit business relationships with customers from,Europe,America and south Asia,supplying obsolete and hard-to-find components to meet their specific needs.

With the principle of "Quality Parts,Customers Priority,Honest Operation,and Considerate Service",our business mainly focus on the distribution of electronic components. Line cards we deal with include Microchip,ALPS,ROHM,Xilinx,Pulse,ON,Everlight and Freescale. Main products comprise IC,Modules,Potentiometer,IC Socket,Relay,Connector.Our parts cover such applications as commercial,industrial, and automotives areas.

We are looking forward to setting up business relationship with you and hope to provide you with the best service and solution. Let us make a better world for our industry!



## Contact us

Tel: +86-755-8981 8866 Fax: +86-755-8427 6832

Email & Skype: info@chipsmall.com Web: www.chipsmall.com

Address: A1208, Overseas Decoration Building, #122 Zhenhua RD., Futian, Shenzhen, China



1

# MAB1 Stößel

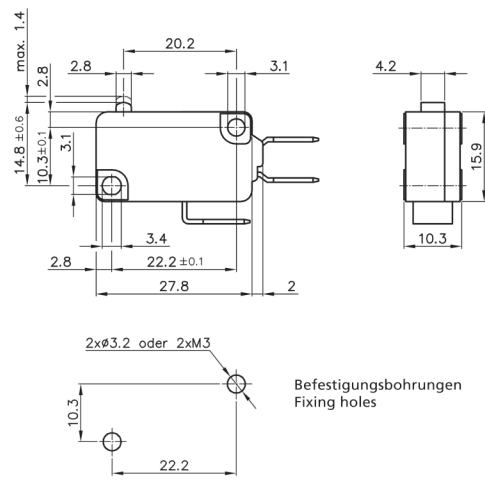

## Blattfeder Kontaktsystem

- Microschalter Bauform A gem. DIN 41635
- funktionale Endkontrolle
- solide Konstruktion
- hochwertige Materialien
- sehr genaue Schaltlage
- Sonderausführung mit 3,5N erfüllt Glühdrahtprüfung GWT750°C/2s nach DIN EN6335-1 (Hausgerätenorm)

## Leaf spring mechanism

- Micro switches design A acc. to DIN 41635
- functional final inspection and testing
- solid design
- high-quality materials
- very exact switching position
- special version 3.5N fulfils glow wire testing GWT750°C/2s acc. DIN EN6335-1 (household appliance standard)

Microschalter, auch als Schnappschalter bezeichnet, werden vorrangig als Endschalter eingesetzt, sind aber auch für viele weitere Industrieanwendungen geeignet. Die Schaltgeschwindigkeit ist weitgehend unabhängig von der eigentlichen Betätigungsgeschwindigkeit. Die nach ISO 9001:2000 zertifizierte Fertigung und die 100% funktionale Endkontrolle garantieren die zuverlässige Funktion. Bei diesen Schaltern haben wir unsere langjährige Erfahrung und Zuverlässigkeit im Schalterbau eingebracht.

Micro switches, also known as snap action switches, are primarily used as limit switches, but are also suitable for many other industry applications. The actual switching speed is completely independent from the speed of operation. ISO 9001:2000 approved production together with 100% functional final inspection and testing guarantee reliable operation. These products reflect our long standing experience in design and production of high quality switches.

MECHANISCHE KENNWERTE	MECHANICAL DATA	
Mech. Lebensdauer	Mech. lifetime	2 000 000 Schaltungen / 2 000 000 actuations
Sonderausführung 3,5N	Special version 3.5N	10 000 000 Schaltungen / 10 000 000 actuations
Elektr. Lebensdauer	Electrical lifetime	min. 50 000 Schaltungen / min. 50 000 actuations
abhängig von Schaltleistung	depending on switching capacity	
Differenzweg	Movement differential	≤ 0,4mm
Vorlaufweg	Pretravel	≤ 1,4mm
Nachlaufweg	Overtravel	0,75 - 1,5mm
Schaltpunkt	Operating position	14,8 ± 0,6mm
Kontaktöffnungsweite	Contact opening	<3mm (μ)
SONSTIGE KENNWERTE	OTHER DATA	
Zulassungen	Approvals	ENEC-VDE, cULus
MATERIAL	MATERIAL	
Gehäuse	Housing	PBT/PET (UL94-V0)
Deckel	Cover	PBT/PET (UL94-V0)
Betätiger	Actuator	Phenolic (UL94-V0)
Anschlüsse	Terminals	CuZn versilbert / CuZn Ag plated
Kontakte	Contacts	AgNi
Kontaktgeber	Contact spring	CuBe

# MAB1 Plunger

## 2 SCHALTLEISTUNG / RATING

	cULus		Code: MAB1	01	3	4	5	6	7	8	9
1(0,3)A 250VAC	1A 125VAC		MAB1	01	3	4	5	6	7	8	9
5(2)A 250VAC	5A 125VAC		MAB1	02	3	4	5	6	7	8	9
10(3)A 250VAC	10A 125VAC		MAB1	03	3	4	5	6	7	8	9
16(4)A 250VAC	16A 125VAC		MAB1	04	3	4	5	6	7	8	9

## 3 BETÄTIGUNGSKRAFT / OPERATING FORCE

			Code: MAB1	2	A	4	5	6	7	8	9
0,8N		MAB1	2	A	4	5	6	7	8	9	
1,0N		MAB1	2	B	4	5	6	7	8	9	
1,5N		MAB1	2	C	4	5	6	7	8	9	
2,0N		MAB1	2	D	4	5	6	7	8	9	
2,5N		MAB1	2	E	4	5	6	7	8	9	
3,0N		MAB1	2	F	4	5	6	7	8	9	
3,5N		MAB1	2	G	4	5	6	7	8	9	
4,0N		MAB1	2	H	4	5	6	7	8	9	

## EMPFOHLENE KOMBINATIONEN / RECOMMENDED COMBINATIONS

	0,8N	1,0N	1,5N	2,0N	2,5N	3,0N	3,5N	4,0N
1(0,3)A 250VAC	■	■	■	■	■	■		■
5(2)A 250VAC	■	■	■	■	■	■		■
10(3)A 250VAC		■	■	■	■	■		■
16(4)A 250VAC			■	■	■	■	■	■

## 4 UMGEBUNGSTEMPERATUR / AMBIENT TEMPERATURE

-10...+105°C		Code: MAB1	2	3	01	5	6	7	8	9
-10...+125°C		Code: MAB1	2	3	02	5	6	7	8	9

## 5 KONTAKTANORDNUNG / CONTACT ARRANGEMENT

Öffner / Normally closed	Schließer / Normally open	Wechsler / Change-over
Code: MAB1 2 3 4 <b>A</b> 6 7 8 9	Code: MAB1 2 3 4 <b>B</b> 6 7 8 9	Code: MAB1 2 3 4 <b>C</b> 6 7 8 9

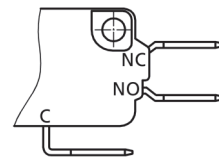
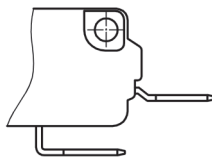
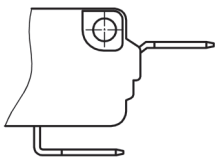

## 6 BETÄTIGER / ACTUATOR

Stößel / Plunger
Code: MAB1 2 3 4 5 <b>01</b> 7 8 9

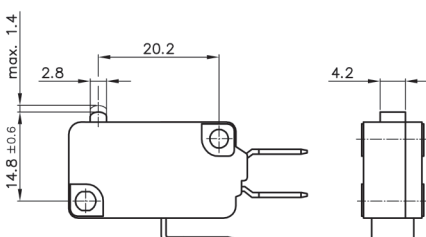

## 7 EINHÄNGEPUNKT / FIXING POSITION

Kein Zusatzbetätiger / No additional actuator
Code: MAB1 2 3 4 5 6 <b>X</b> 8 9

=auf Anfrage / upon request

# MAB1 Stöbel

8

## ANSCHLÜSSE / TERMINALS

Steckanschluss 0,8x6,3mm / Plug connection

Code: MAB1 2 3 4 5 6 7 01 9

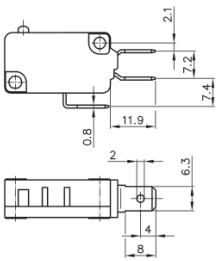

Steckanschluss 0,5x4,7mm / Plug connection

Code: MAB1 2 3 4 5 6 7 02 9

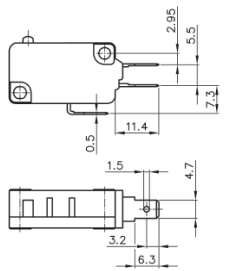

Steckanschluss 0,8x4,7mm / Plug connection

Code: MAB1 2 3 4 5 6 7 03 9

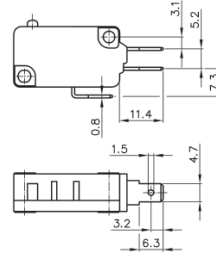

Steck/Lötanschluss 0,5x4,7mm

Plug/solder terminal

Code: MAB1 2 3 4 5 6 7 04 9

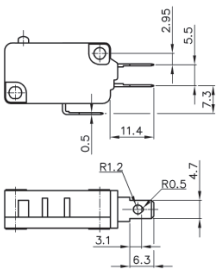

LP-Anschluss links / PCB terminal left

Code: MAB1 2 3 4 5 6 7 05 9

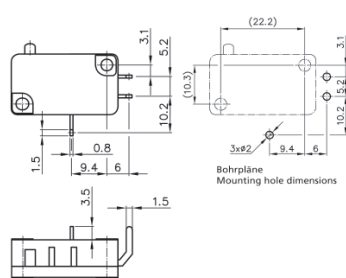

LP-Anschluss rechts / PCB terminal right

Code: MAB1 2 3 4 5 6 7 06 9

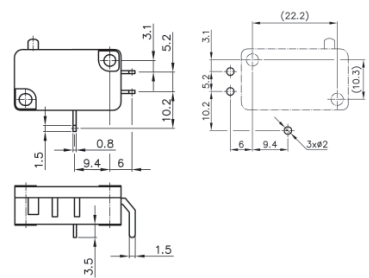

Lötöse / Solder terminal

Code: MAB1 2 3 4 5 6 7 07 9

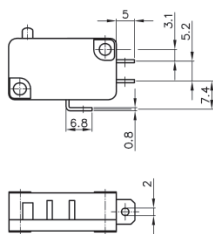

Schraubanschluss / Screw terminal

Code: MAB1 2 3 4 5 6 7 08 9

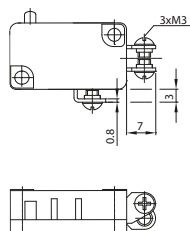

Rast 5 / Pin spacing 5

Code: MAB1 2 3 4 5 6 7 09 9

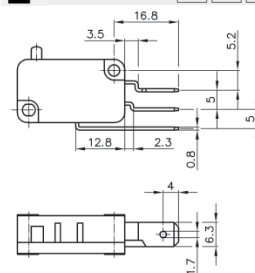

9

## KONTAKTÖFFNUNG / CONTACT GAP

<3mm (Standard)

Code: MAB1 2 3 4 5 6 7 8 A

# MAB1 Plunger

ÜBERSICHT BETÄTIGER / WEGE / KRÄFTE  
 OVERVIEW ACTUATORS / TRAVEL / FORCES

	Code	mm	≤ N	Code	≤ N	≤ mm	min. mm	≤ mm	≤ mm	mm
		Zusatzbetätigerlänge Actuator length	Betätigungskraft am Stößel Operating force on plunger		Betätigungskraft am Zusatzbetätiger Operating force on lever	Vorlaufweg Pretravel	Nachlaufweg Overtravel	Differenzweg Movement differential	Ruhestellung Free position	Schaltpunkt Operating position
Stößel	01	-	0,8	A	-	1,4	0,75 - 1,5	0,4	16,8	14,8 ± 0,6
Plunger			1,0	B						
			1,5	C						
			2,0	D						
			2,5	E						
			3,0	F						
			3,5	G						
			4,0	H						

1

# MAB1 Hebel

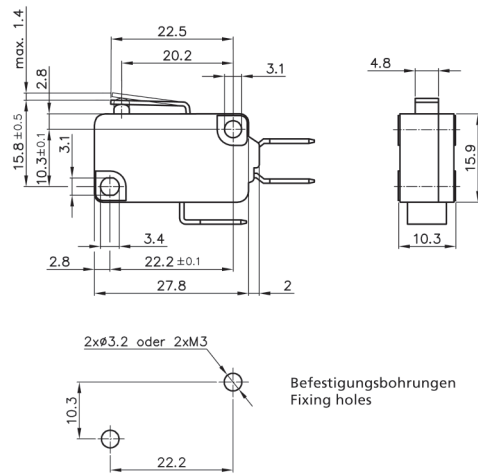
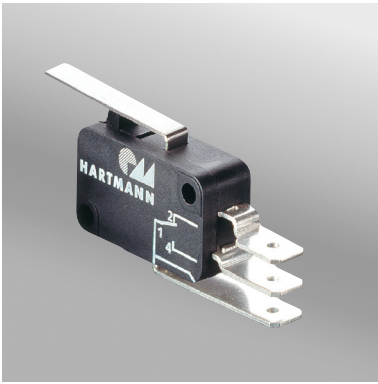

## Blattfeder Kontaktsystem

- Microschalter Bauform A gem. DIN 41635
- funktionale Endkontrolle
- solide Konstruktion
- hochwertige Materialien
- sehr genaue Schaltlage
- Sonderausführung mit 3,5N erfüllt Glühdrahtprüfung GWT750°C/2s nach DIN EN6335-1 (Hausgerätenorm)

## Leaf spring mechanism

- Micro switches design A acc. to DIN 41635
- functional final inspection and testing
- solid design
- high-quality materials
- very exact switching position
- special version 3.5N fulfills glow wire testing GWT750°C/2s acc. DIN EN6335-1 (household appliance standard)

Microschalter, auch als Schnappschalter bezeichnet, werden vorrangig als Endschalter eingesetzt, sind aber auch für viele weitere Industrieanwendungen geeignet. Die Schaltgeschwindigkeit ist weitgehend unabhängig von der eigentlichen Betätigungsgeschwindigkeit. Die nach ISO 9001:2000 zertifizierte Fertigung und die 100% funktionale Endkontrolle garantieren die zuverlässige Funktion. Bei diesen Schaltern haben wir unsere langjährige Erfahrung und Zuverlässigkeit im Schalterbau eingebracht.

Micro switches, also known as snap action switches, are primarily used as limit switches, but are also suitable for many other industry applications. The actual switching speed is completely independent from the speed of operation. ISO 9001:2000 approved production together with 100% functional final inspection and testing guarantee reliable operation. These products reflect our long standing experience in design and production of high quality switches.

MECHANISCHE KENNWERTE	MECHANICAL DATA	
Mech. Lebensdauer	Mech. lifetime	2 000 000 Schaltungen / 2 000 000 actuations
Sonderausführung 3,5N	Special version 3.5N	10 000 000 Schaltungen / 10 000 000 actuations
Elektr. Lebensdauer	Electrical lifetime	min. 50 000 Schaltungen / min. 50 000 actuations
abhängig von Schaltleistung	depending on switching capacity	
Differenzweg	Movement differential	siehe Übersicht nächste Seite / please see overview next page
Vorlaufweg	Pretravel	siehe Übersicht nächste Seite / please see overview next page
Nachlaufweg	Overtravel	siehe Übersicht nächste Seite / please see overview next page
Schaltpunkt	Operating position	siehe Übersicht nächste Seite / please see overview next page
Kontaktöffnungsweite	Contact opening	<3mm (µ)
SONSTIGE KENNWERTE	OTHER DATA	
Zulassungen	Approvals	ENEC-VDE, cULus
MATERIAL	MATERIAL	
Gehäuse	Housing	PBT/PET (UL94-V0)
Deckel	Cover	PBT/PET (UL94-V0)
Betätiger	Actuator	Phenolic (UL94-V0)
Anschlüsse	Terminals	CuZn versilbert / CuZn Ag plated
Kontakte	Contacts	AgNi
Kontaktgeber	Contact spring	CuBe

# MAB1 Hinge lever

## 2 SCHALTLEISTUNG / RATING

	cULus		Code: MAB1	01	3	4	5	6	7	8	9
1(0,3)A 250VAC	1A 125VAC		MAB1	01	3	4	5	6	7	8	9
5(2)A 250VAC	5A 125VAC		MAB1	02	3	4	5	6	7	8	9
10(3)A 250VAC	10A 125VAC		MAB1	03	3	4	5	6	7	8	9
16(4)A 250VAC	16A 125VAC		MAB1	04	3	4	5	6	7	8	9

## 3 BETÄTIGUNGSKRAFT / OPERATING FORCE

0,8N		Code: MAB1	2	A	4	5	6	7	8	9
1,0N		Code: MAB1	2	B	4	5	6	7	8	9
1,5N		Code: MAB1	2	C	4	5	6	7	8	9
2,0N		Code: MAB1	2	D	4	5	6	7	8	9
2,5N		Code: MAB1	2	E	4	5	6	7	8	9
3,0N		Code: MAB1	2	F	4	5	6	7	8	9
3,5N		Code: MAB1	2	G	4	5	6	7	8	9
4,0N		Code: MAB1	2	H	4	5	6	7	8	9

## EMPFOLHENE KOMBINATIONEN / RECOMMENDED COMBINATIONS

	0,8N	1,0N	1,5N	2,0N	2,5N	3,0N	3,5N	4,0N
1(0,3)A 250VAC	■	■	■	■	■	■		■
5(2)A 250VAC	■	■	■	■	■	■		■
10(3)A 250VAC		■	■	■	■	■		■
16(4)A 250VAC			■	■	■	■	■	■

## 4 UMGEBUNGSTEMPERATUR / AMBIENT TEMPERATURE

-10...+105°C		Code: MAB1	2	3	01	5	6	7	8	9
-10...+125°C		Code: MAB1	2	3	02	5	6	7	8	9

## 5 KONTAKTANORDNUNG / CONTACT ARRANGEMENT

Öffner / Normally closed		Code: MAB1	2	3	4	A	6	7	8	9
Schließer / Normally open		Code: MAB1	2	3	4	B	6	7	8	9
Wechsler / Change-over		Code: MAB1	2	3	4	C	6	7	8	9

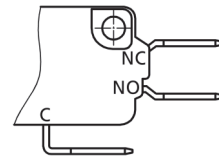
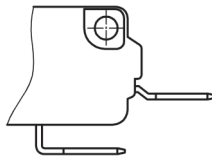
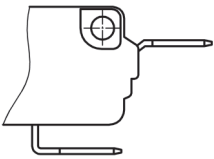

## 6 BETÄTIGER / ACTUATOR

Hebel kurz / Hinge lever short		Code: MAB1	2	3	4	5	03	7	8	9
Hebel mittel / Hinge lever medium size		Code: MAB1	2	3	4	5	04	7	8	9
Hebel lang / Hinge lever long		Code: MAB1	2	3	4	5	05	7	8	9

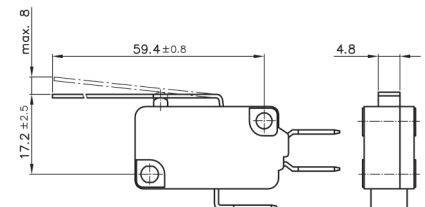
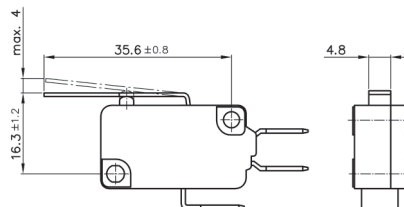
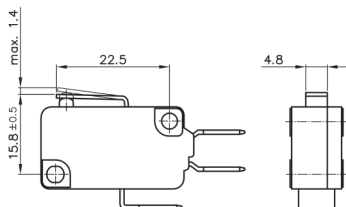

## 7 EINHÄNGEPUNKT / FIXING POSITION

vorne / front		Code: MAB1	2	3	4	5	6	A	8	9
hinten / rear		Code: MAB1	2	3	4	5	6	B	8	9

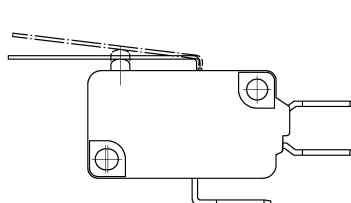
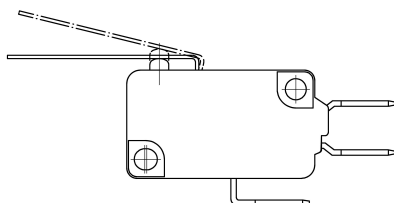

= auf Anfrage / upon request

# MAB1 Hebel

## 8 ANSCHLÜSSE / TERMINALS

Steckanschluss 0,8x6,3mm / Plug connection

Code: MAB1 2 3 4 5 6 7 01 9

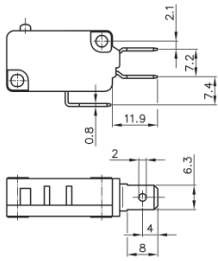

Steckanschluss 0,5x4,7mm / Plug connection

Code: MAB1 2 3 4 5 6 7 02 9

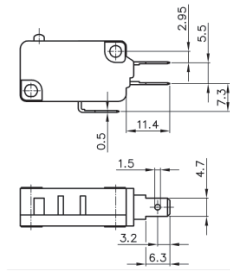

Steckanschluss 0,8x4,7mm / Plug connection

Code: MAB1 2 3 4 5 6 7 03 9

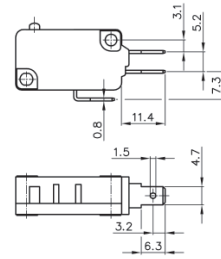

Steck/Lötanschluss 0,5x4,7mm / Plug/solder terminal

Code: MAB1 2 3 4 5 6 7 04 9

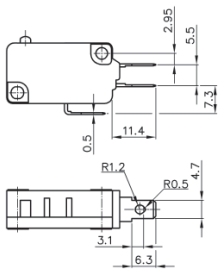

LP-Anschluss links / PCB terminal left

Code: MAB1 2 3 4 5 6 7 05 9

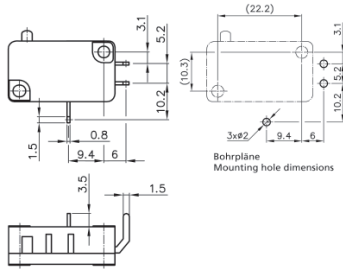

LP-Anschluss rechts / PCB terminal right

Code: MAB1 2 3 4 5 6 7 06 9

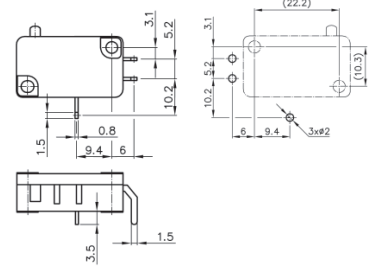

Lötöse / Solder terminal

Code: MAB1 2 3 4 5 6 7 07 9

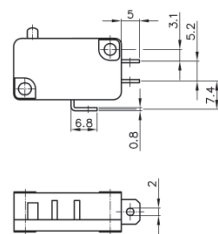

Schraubanschluss / Screw terminal

Code: MAB1 2 3 4 5 6 7 08 9

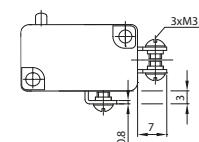

Rast 5 / Pin spacing 5

Code: MAB1 2 3 4 5 6 7 09 9

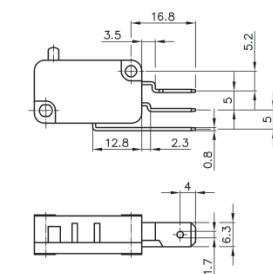

## 9 KONTAKTÖFFNUNG / CONTACT GAP

<3mm (Standard)

Code: MAB1 2 3 4 5 6 7 8 A





1

# MAB1 Rolle

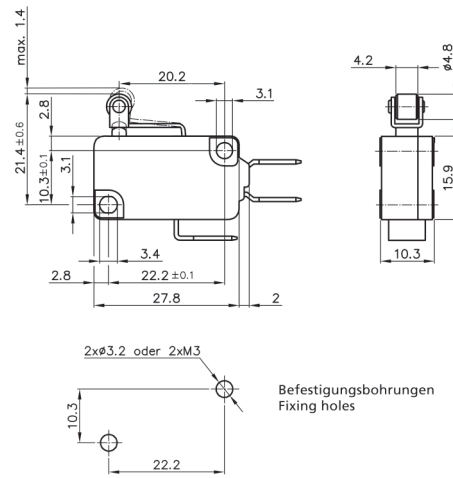

## Blattfeder Kontaktsystem

- Microschalter Bauform A gem. DIN 41635
- funktionale Endkontrolle
- solide Konstruktion
- hochwertige Materialien
- sehr genaue Schaltlage
- Sonderausführung mit 3,5N erfüllt Glühdrahtprüfung GWT750°C/2s nach DIN EN6335-1 (Hausgerätenorm)

Microschalter, auch als Schnappschalter bezeichnet, werden vorrangig als Endschalter eingesetzt, sind aber auch für viele weitere Industrieanwendungen geeignet. Die Schaltgeschwindigkeit ist weitgehend unabhängig von der eigentlichen Betätigungsgeschwindigkeit. Die nach ISO 9001:2000 zertifizierte Fertigung und die 100% funktionale Endkontrolle garantieren die zuverlässige Funktion. Bei diesen Schaltern haben wir unsere langjährige Erfahrung und Zuverlässigkeit im Schalterbau eingebracht.

## Leaf spring mechanism

- Micro switches design A acc. to DIN 41635
- functional final inspection and testing
- solid design
- high-quality materials
- very exact switching position
- special version 3.5N fulfills glow wire testing GWT750°C/2s acc. DIN EN6335-1 (household appliance standard)

Micro switches, also known as snap action switches, are primarily used as limit switches, but are also suitable for many other industry applications. The actual switching speed is completely independent from the speed of operation. ISO 9001:2000 approved production together with 100% functional final inspection and testing guarantee reliable operation. These products reflect our long standing experience in design and production of high quality switches.

MECHANISCHE KENNWERTE	MECHANICAL DATA	
Mech. Lebensdauer	Mech. lifetime	2 000 000 Schaltungen / 2 000 000 actuations
Sonderausführung 3,5N	Special version 3.5N	10 000 000 Schaltungen / 10 000 000 actuations
Elektr. Lebensdauer	Electrical lifetime	min. 50 000 Schaltungen / min. 50 000 actuations
abhängig von Schaltleistung	depending on switching capacity	
Differenzweg	Movement differential	siehe Übersicht nächste Seite / please see overview next page
Vorlaufweg	Pretravel	siehe Übersicht nächste Seite / please see overview next page
Nachlaufweg	Overtravel	siehe Übersicht nächste Seite / please see overview next page
Schaltpunkt	Operating position	siehe Übersicht nächste Seite / please see overview next page
Kontaktöffnungsweite	Contact opening	<3mm
SONSTIGE KENNWERTE	OTHER DATA	
Zulassungen	Approvals	ENEC-VDE, cULus
MATERIAL	MATERIAL	
Gehäuse	Housing	PBT/PET (UL94-V0)
Deckel	Cover	PBT/PET (UL94-V0)
Betätiger	Actuator	Phenolic (UL94-V0)
Anschlüsse	Terminals	CuZn versilbert / CuZn Ag plated
Kontakte	Contacts	AgNi
Kontaktgeber	Contact spring	CuBe

# MAB1 Roller lever

## 2 SCHALTLEISTUNG / RATING

	cULus		Code: MAB1	01	3	4	5	6	7	8	9
1(0,3)A 250VAC	1A 125VAC		Code: MAB1	02	3	4	5	6	7	8	9
5(2)A 250VAC	5A 125VAC		Code: MAB1	03	3	4	5	6	7	8	9
10(3)A 250VAC	10A 125VAC		Code: MAB1	04	3	4	5	6	7	8	9
16(4)A 250VAC	16A 125VAC		Code: MAB1	04	3	4	5	6	7	8	9

## 3 BETÄTIGUNGSKRAFT / OPERATING FORCE

			Code: MAB1	2	A	4	5	6	7	8	9
0,8N		Code: MAB1	2	B	4	5	6	7	8	9	
1,0N		Code: MAB1	2	C	4	5	6	7	8	9	
1,5N		Code: MAB1	2	D	4	5	6	7	8	9	
2,0N		Code: MAB1	2	E	4	5	6	7	8	9	
2,5N		Code: MAB1	2	F	4	5	6	7	8	9	
3,0N		Code: MAB1	2	G	4	5	6	7	8	9	
3,5N		Code: MAB1	2	H	4	5	6	7	8	9	
4,0N		Code: MAB1	2	H	4	5	6	7	8	9	

## EMPFOHLENE KOMBINATIONEN / RECOMMENDED COMBINATIONS

	0,8N	1,0N	1,5N	2,0N	2,5N	3,0N	3,5N	4,0N
1(0,3)A 250VAC	■	■	■	■	■	■		■
5(2)A 250VAC	■	■	■	■	■	■		■
10(3)A 250VAC		■	■	■	■	■		■
16(4)A 250VAC			■	■	■	■	■	■

## 4 UMGEBUNGSTEMPERATUR / AMBIENT TEMPERATURE

-10...+105°C		Code: MAB1	2	3	01	5	6	7	8	9
-10...+125°C		Code: MAB1	2	3	02	5	6	7	8	9

## 5 KONTAKTANORDNUNG / CONTACT ARRANGEMENT

Öffner / Normally closed	Schließer / Normally open	Wechsler / Change-over
Code: MAB1 2 3 4 <b>A</b> 6 7 8 9	Code: MAB1 2 3 4 <b>B</b> 6 7 8 9	Code: MAB1 2 3 4 <b>C</b> 6 7 8 9

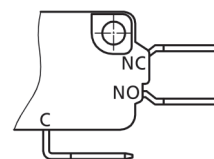
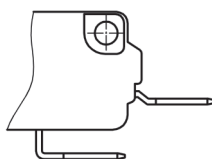
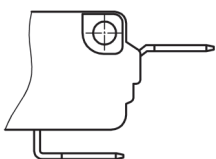

## 6 BETÄTIGER / ACTUATOR

Rolle kurz / Roller lever short	Rolle lang / Roller lever long	Simulierte Rolle / Simulated roller
Code: MAB1 2 3 4 5 <b>06</b> 7 8 9	Code: MAB1 2 3 4 5 <b>07</b> 7 8 9	Code: MAB1 2 3 4 5 <b>08</b> 7 8 9

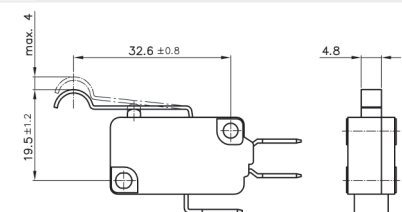
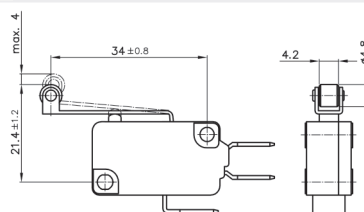
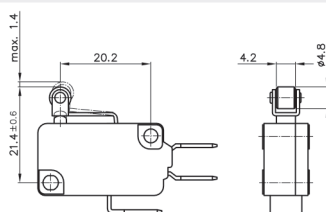

## 7 EINHÄNGEPUNKT / FIXING POSITION

vorne / front	hinten / rear
Code: MAB1 2 3 4 5 6 <b>A</b> 8 9	Code: MAB1 2 3 4 5 6 <b>B</b> 8 9

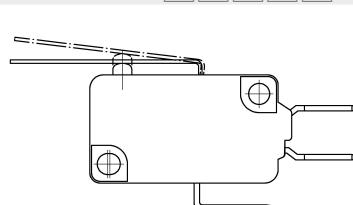
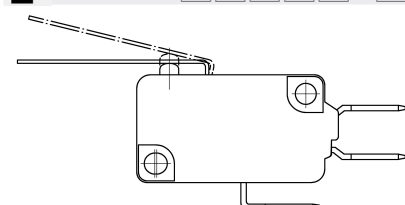

=auf Anfrage / upon request

# MAB1 Rolle

## 8 ANSCHLÜSSE / TERMINALS

Steckanschluss 0,8x6,3mm / Plug connection

Code: MAB1 2 3 4 5 6 7 01 9

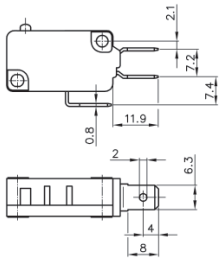

Steckanschluss 0,5x4,7mm / Plug connection

Code: MAB1 2 3 4 5 6 7 02 9

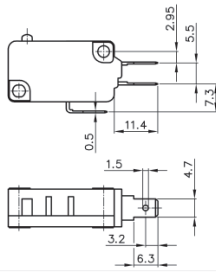

Steckanschluss 0,8x4,7mm / Plug connection

Code: MAB1 2 3 4 5 6 7 03 9

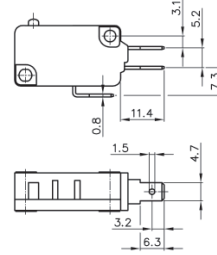

Steck/Löten. 0,5x4,7mm / Plug/solder terminal

Code: MAB1 2 3 4 5 6 7 04 9

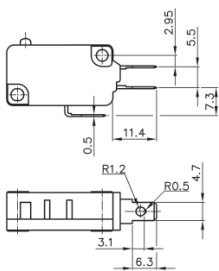

LP-Anschluss links / PCB terminal left

Code: MAB1 2 3 4 5 6 7 05 9

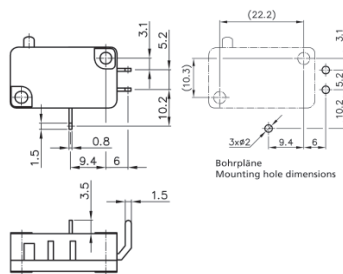

LP-Anschluss rechts / PCB terminal right

Code: MAB1 2 3 4 5 6 7 06 9

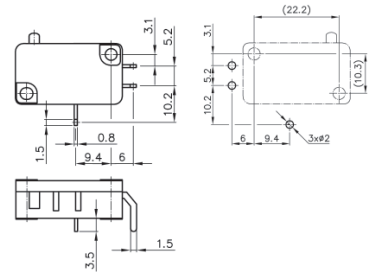

Lötöse / Solder terminal

Code: MAB1 2 3 4 5 6 7 07 9

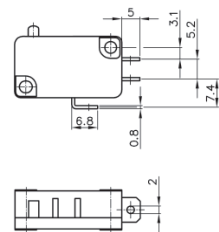

Schraubanschluss / Screw terminal

Code: MAB1 2 3 4 5 6 7 08 9

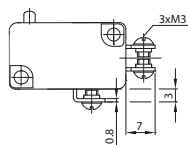

Rast 5 / Pin spacing 5

Code: MAB1 2 3 4 5 6 7 09 9

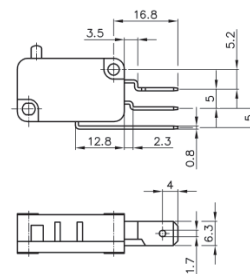

## 9 KONTAKTÖFFNUNG / CONTACT GAP

<3mm (Standard)

Code: MAB1 2 3 4 5 6 7 8 A



**1**

# Zubehör/Accessories

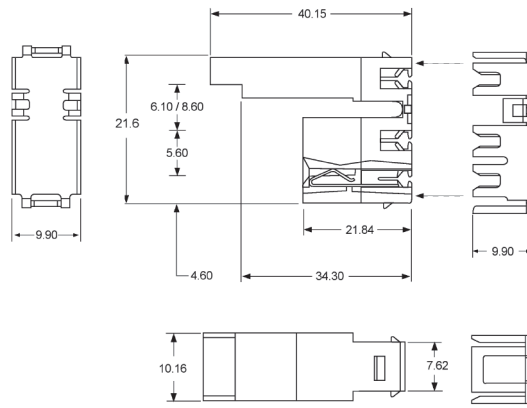
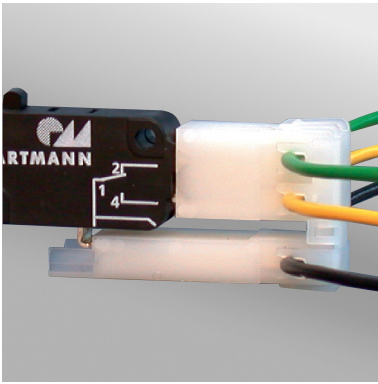

## Stecker für Steckanschluss 0,5x4,7mm

- Alternative zu Einzelverdrahtung
- für End- und Durchgangsverbindungen
- zuverlässiger und schneller Schneidklemmanschluss
- zusätzliche Zugentlastungskappe montierbar
- servicefreundlich durch einfaches Aufstecken und Abziehen

## Connector for Plug Connection 0.5x4.7mm

- alternative solution to discrete wiring
- for end- and feed-through connections
- reliable and fast IDC connection
- strain relief cap available
- easy on and easy off maintenance

### MECHANISCHE KENNWERTE

Umgebungstemperatur	Ambient temperature	-55...+85°C
Zulassungen	Approvals	UL

### MECHANICAL DATA

### ELEKTRISCHE KENNWERTE

Stromtragfähigkeit	Current rating	
bei AWG18 (ca. 0,8mm <sup>2</sup> )	for AWG18 (approx. 0.8mm <sup>2</sup> )	10A
bei AWG20 (ca. 0,5mm <sup>2</sup> )	for AWG20 (approx. 0.5mm <sup>2</sup> )	6,5A
bei AWG22 (ca. 0,3mm <sup>2</sup> )	for AWG22 (approx. 0.3mm <sup>2</sup> )	6,5A
Prüfspannung	Test voltage	3,8kVAC
Isolationswiderstand	Insulation resistance	>5000MΩ

### ELECTRICAL DATA

### MATERIAL

Gehäuse	Housing	PA(UL94-V2)
Kontakte	Contacts	Phosphorbronze / Phosphor Bronze
Oberfläche	Plating	Zinn über Nickel / Tin over Nickel

### MATERIAL

## BESTELLBEZEICHNUNG / ORDERCODE

Stecker für AWG18 / Connector for AWG18	Code: SMA02 180301
Stecker für AWG20 / Connector for AWG20	Code: SMA02 200301
Stecker für AWG22 / Connector for AWG22	Code: SMA02 220301
Kappe für AWG18 / Cap for AWG18	Code: ZMA02 18
Kappe für AWG20, 22 / Cap for AWG20, 22	Code: ZMA02 20
Manuelles Montagewerkzeug / Manual fitting tool	Code: WMA02 M

# 1 Zubehör/Accessories

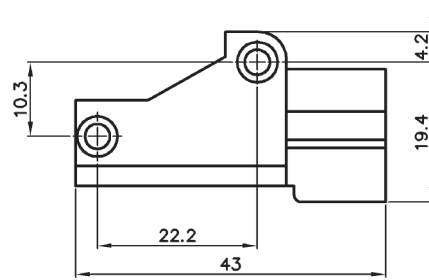
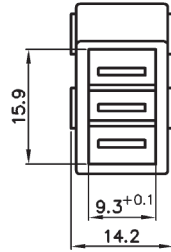

## Adaptergehäuse für Rast5-Steckanschluss

- sichere Verbindung der Schalter mit dem Adaptergehäuse durch Befestigungsbohrungen

MATERIAL	MATERIAL	
Gehäuse	Housing	PBT
Farbe	Colour	schwarz / black

## BESTELLBEZEICHNUNG / ORDERCODE

Adaptergehäuse / Adapter element
Code: Adaptergehäuse / Adapter element

## Adapter element for Rast5-plug-connection

- reliable joining of switch and adapter element by fixing holes