



Chipsmall Limited consists of a professional team with an average of over 10 year of expertise in the distribution of electronic components. Based in Hongkong, we have already established firm and mutual-benefit business relationships with customers from,Europe,America and south Asia,supplying obsolete and hard-to-find components to meet their specific needs.

With the principle of “Quality Parts,Customers Priority,Honest Operation,and Considerate Service”,our business mainly focus on the distribution of electronic components. Line cards we deal with include Microchip,ALPS,ROHM,Xilinx,Pulse,ON,Everlight and Freescale. Main products comprise IC,Modules,Potentiometer,IC Socket,Relay,Connector.Our parts cover such applications as commercial,industrial, and automotives areas.

We are looking forward to setting up business relationship with you and hope to provide you with the best service and solution. Let us make a better world for our industry!



Contact us

Tel: +86-755-8981 8866 Fax: +86-755-8427 6832

Email & Skype: info@chipsmall.com Web: www.chipsmall.com

Address: A1208, Overseas Decoration Building, #122 Zhenhua RD., Futian, Shenzhen, China



Electrical Specifications: $T_A = 25^\circ\text{C}$, 0dBm , $Z_0 = 75\Omega$, $P_{in} = 0\text{dBm}$

Parameter	Test Conditions	Units	Min	Typ	Max
Insertion Loss	5 - 60 MHz	dB	-	0.3	0.6
	60 - 150 MHz	dB	-	0.4	0.8
	150 - 200 MHz	dB	-	0.7	1.0
Amplitude Unbalance (Nominal 0dB)	5 - 60 MHz	dB	-	0.0	± 0.1
	60 - 200 MHz	dB	-	0.2	± 0.4
Phase Unbalance (Nominal 180°)	5 - 60 MHz	°	-	0.1	± 2.0
	60 - 200 MHz	°	-	0.3	± 4.0
Input Return Loss	5 - 60 MHz	dB	22	31	-
	60 - 200 MHz	dB	14	17	-

Recommended Maximum Ratings

Parameter	Value
Input power	+28dBm (631mW)
DC current (tested at 5V)	600mA
Operating Temperature	-40°C to +100°C
Storage Temperature	-55°C to +100°C

Application Circuit

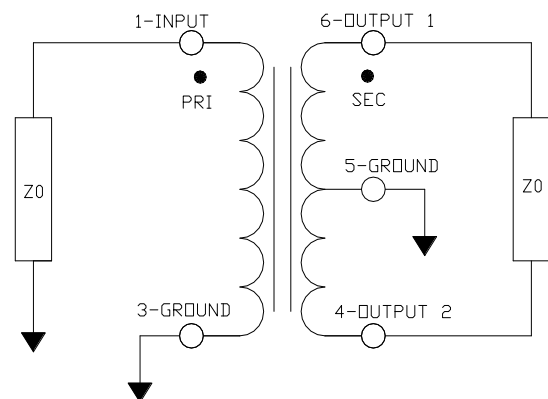

Typical Performance Curves: $T_A = 25^\circ\text{C}$, 0dBm , $Z_0 = 75\Omega$, $P_{in} = 0\text{dBm}$

Insertion Loss 1: (Pin 1 to 6)

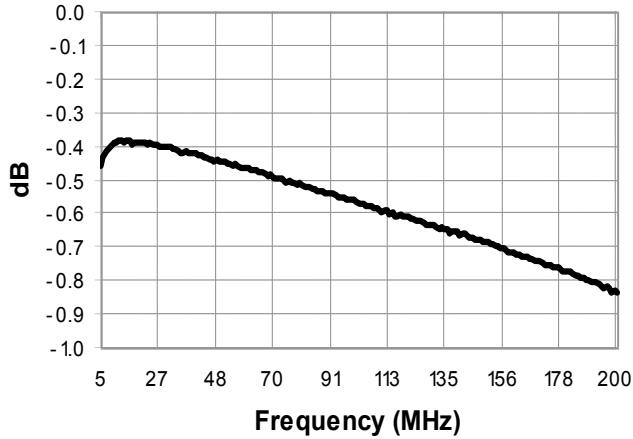

Insertion Loss 2: (Pin 1 to 4)

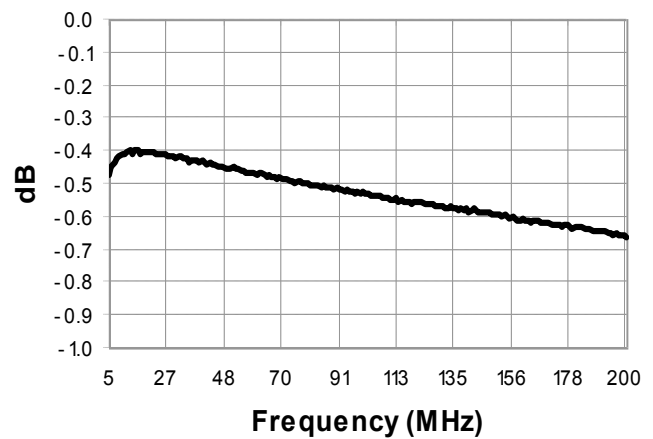

Amplitude Balance

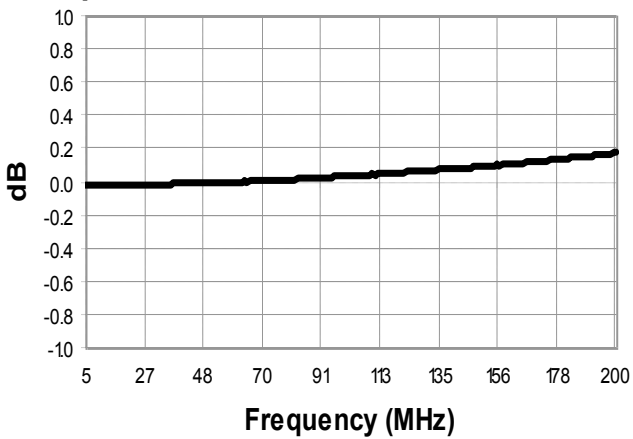

Phase Balance

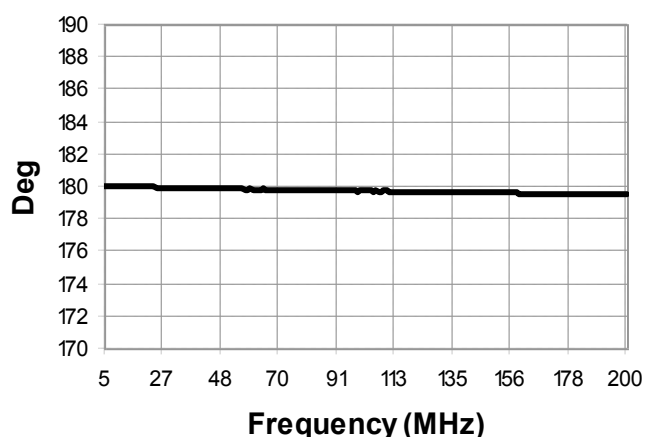

Return Loss: Input

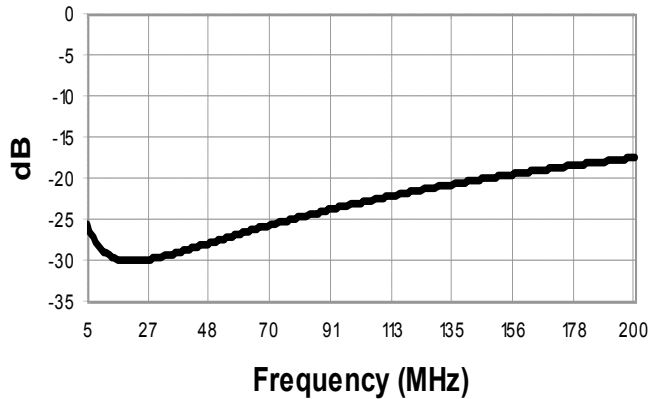

Tape & Reel Information

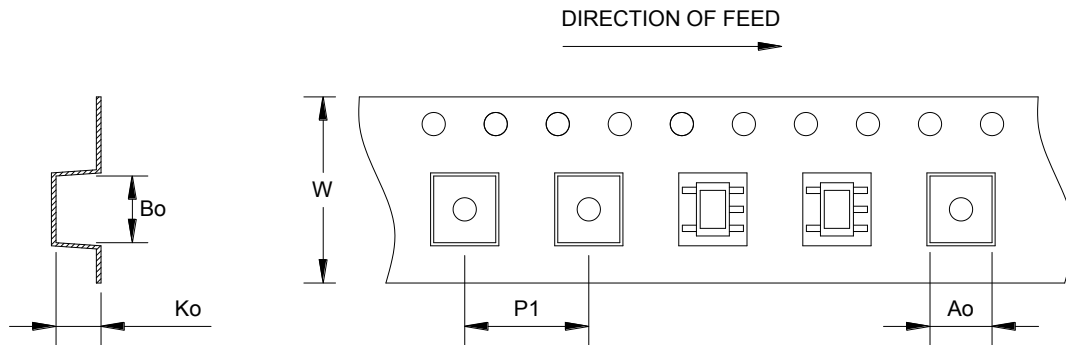

Item	Dimension
Ao	5.60mm +/- 0.1mm
Bo	4.50mm +/- 0.1mm
Ko	4.00mm +/- 0.1mm
W	12.00mm +/- 0.3mm
P1	8.00mm +/- 0.1mm

Ordering Information

Part number	Description
MABA-009594-CF18A0	2000 piece reel
MABA-009594-CF18TB	Customer Test Board

M/A-COM Technology Solutions Inc. All rights reserved.

Information in this document is provided in connection with M/A-COM Technology Solutions Inc ("MACOM") products. These materials are provided by MACOM as a service to its customers and may be used for informational purposes only. Except as provided in MACOM's Terms and Conditions of Sale for such products or in any separate agreement related to this document, MACOM assumes no liability whatsoever. MACOM assumes no responsibility for errors or omissions in these materials. MACOM may make changes to specifications and product descriptions at any time, without notice. MACOM makes no commitment to update the information and shall have no responsibility whatsoever for conflicts or incompatibilities arising from future changes to its specifications and product descriptions. No license, express or implied, by estoppel or otherwise, to any intellectual property rights is granted by this document.

THESE MATERIALS ARE PROVIDED "AS IS" WITHOUT WARRANTY OF ANY KIND, EITHER EXPRESS OR IMPLIED, RELATING TO SALE AND/OR USE OF MACOM PRODUCTS INCLUDING LIABILITY OR WARRANTIES RELATING TO FITNESS FOR A PARTICULAR PURPOSE, CONSEQUENTIAL OR INCIDENTAL DAMAGES, MERCHANTABILITY, OR INFRINGEMENT OF ANY PATENT, COPYRIGHT OR OTHER INTELLECTUAL PROPERTY RIGHT. MACOM FURTHER DOES NOT WARRANT THE ACCURACY OR COMPLETENESS OF THE INFORMATION, TEXT, GRAPHICS OR OTHER ITEMS CONTAINED WITHIN THESE MATERIALS. MACOM SHALL NOT BE LIABLE FOR ANY SPECIAL, INDIRECT, INCIDENTAL, OR CONSEQUENTIAL DAMAGES, INCLUDING WITHOUT LIMITATION, LOST REVENUES OR LOST PROFITS, WHICH MAY RESULT FROM THE USE OF THESE MATERIALS.

MACOM products are not intended for use in medical, lifesaving or life sustaining applications. MACOM customers using or selling MACOM products for use in such applications do so at their own risk and agree to fully indemnify MACOM for any damages resulting from such improper use or sale.