



Chipsmall Limited consists of a professional team with an average of over 10 year of expertise in the distribution of electronic components. Based in Hongkong, we have already established firm and mutual-benefit business relationships with customers from,Europe,America and south Asia,supplying obsolete and hard-to-find components to meet their specific needs.

With the principle of “Quality Parts,Customers Priority,Honest Operation,and Considerate Service”,our business mainly focus on the distribution of electronic components. Line cards we deal with include Microchip,ALPS,ROHM,Xilinx,Pulse,ON,Everlight and Freescale. Main products comprise IC,Modules,Potentiometer,IC Socket,Relay,Connector.Our parts cover such applications as commercial,industrial, and automotives areas.

We are looking forward to setting up business relationship with you and hope to provide you with the best service and solution. Let us make a better world for our industry!



Contact us

Tel: +86-755-8981 8866 Fax: +86-755-8427 6832

Email & Skype: info@chipsmall.com Web: www.chipsmall.com

Address: A1208, Overseas Decoration Building, #122 Zhenhua RD., Futian, Shenzhen, China



Frequency Doubler 16 - 24 GHz Output

Rev. V4

Features

- 16 - 24 GHz Output Frequency Range
- 17 dBm Output Power
- High $1x F_{IN}$ and $3x F_{IN}$ Suppression
- High Dynamic Range
- Lead-Free 3 mm, 16-Lead QFN Package
- RoHS* Compliant and 260°C Reflow Compatible

Description

The MAFC-010511 is an active frequency doubler with an output frequency range of 16 - 24GHz. The input power level ranges from -5 to +5 dBm, delivering a typical output power of 17 dBm. The device has excellent input and output return losses, and high $1x F_{in}$ and $3x F_{in}$ isolations.

The MAFC-010511 is ideally suited for use in LO chains in point-to-point radios for cellular backhaul applications. The 3mm QFN package is RoHS compliant and compatible with reflow temperatures to 260°C.

Functional Block Diagram

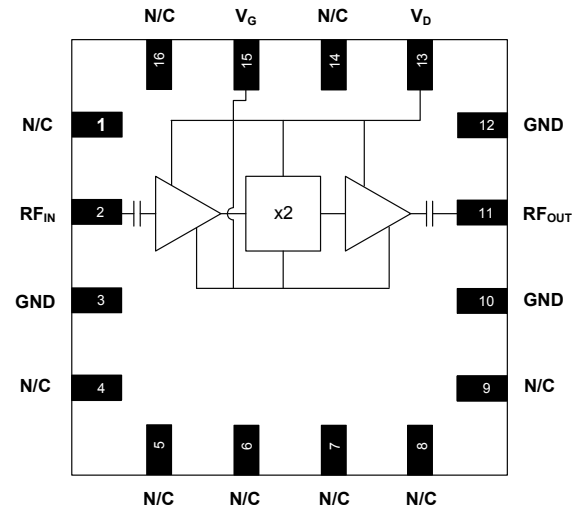

Pin Configuration^{2,3}

Pin No.	Function	Pin No.
1	N/C	No Connection
2	RF _{IN}	RF Input
3	GND	Ground
4	N/C	No Connection
5	N/C	No Connection
6	N/C	No Connection
7	N/C	No Connection
8	N/C	No Connection
9	N/C	No Connection
10	GND	Ground
11	RF _{OUT}	RF Output
12	GND	Ground
13	V _D	Drain Voltage
14	N/C	No Connection
15	V _G	Gate Voltage
16	N/C	No Connection

2. It is recommended that all No Connection pins (N/C) are connected to ground.
3. The exposed pad centered on the package bottom must be connected to RF and DC ground.

Ordering Information¹

Part Number	Package
MAFC-010511-TR0500	500 piece tape and reel
MAFC-010511-TR3000	3000 piece tape and reel
MAFC-010511-001SMB	Sample Test Board

1. Reference Application Note M513 for reel size information.

* Restrictions on Hazardous Substances, European Union Directive 2011/65/EU.

Frequency Doubler 16 - 24 GHz Output

Rev. V4

Electrical Specifications⁴: $V_D = +5\text{ V}$, $V_G = -0.7\text{ V}$, $P_{IN} = 0\text{ dBm}$, $T_A = +25^\circ\text{C}$

Parameter	Units	Min.	Typ.	Max.
Frequency (Input)	GHz	8	—	12
Frequency (Output)	GHz	16	—	24
Output Power (P_{OUT})	dBm	+15	+17	—
$1 \times F_{IN}$ Leakage	dBm	—	-25	—
$3 \times F_{IN}$ Leakage	dBm	—	-15	—
$4 \times F_{IN}$ Leakage	dBm	—	-5	—
Input Return Loss	dB	—	12	—
Output Return Loss	dB	—	12	—
Supply Current (I_D)	mA	—	130	—

4. It is recommended to use active bias on gate voltages to keep the drain currents constant in order to maintain the best performance over temperature.

Absolute Maximum Ratings^{5,6,7}

Parameter	Absolute Maximum
Input Power	+8 dBm
Drain Voltage	+7 V
Gate Voltage	-1.5 V to 0 V
Storage Temperature	-55°C to +150°C
Case Temperature	-40°C to +85°C
Junction Temperature ⁸	+160 °C

5. Exceeding any one or combination of these limits may cause permanent damage to this device.
 6. MACOM does not recommend sustained operation near these survivability limits.
 7. Operating at nominal conditions with $T_J \leq 160^\circ\text{C}$ will ensure $\text{MTTF} > 1 \times 10^6$ hours.
 8. Junction Temperature (T_J) = $T_C + \Theta_{jc} * ((V * I) - (P_{OUT} - P_{IN}))$
 Typical thermal resistance (Θ_{jc}) = 93°C/W.
 a) For $T_C = 25^\circ\text{C}$,
 $T_J = 81^\circ\text{C}$ @ 5 V, 130 mA, $P_{IN} = +5\text{ dBm}$, $P_{OUT} = 17\text{ dBm}$
 b) For $T_C = 85^\circ\text{C}$,
 $T_J = 141^\circ\text{C}$ @ 5 V, 130 mA, $P_{IN} = +5\text{ dBm}$, $P_{OUT} = 17\text{ dBm}$

Handling Procedures

The following precautions should be observed to avoid damage:

Static Sensitivity

Gallium Arsenide Integrated Circuits are sensitive to electrostatic discharge (ESD) and can be damaged by static electricity. Proper ESD control techniques should be used when handling these Class 1A devices.

Frequency Doubler 16 - 24 GHz Output

Rev. V4

Typical Performance Curves: $V_D = +5\text{ V}$, $V_G = -0.7\text{ V}$, $Z_0 = 50\ \Omega$

Output Power @ $2x F_{IN}$ vs. Temp., $P_{IN} = 0\text{ dBm}$

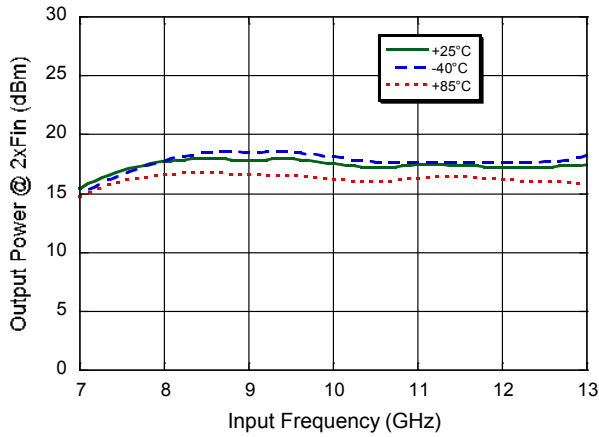

Output Power @ $1x F_{IN}$ vs. Temp., $P_{IN} = 0\text{ dBm}$

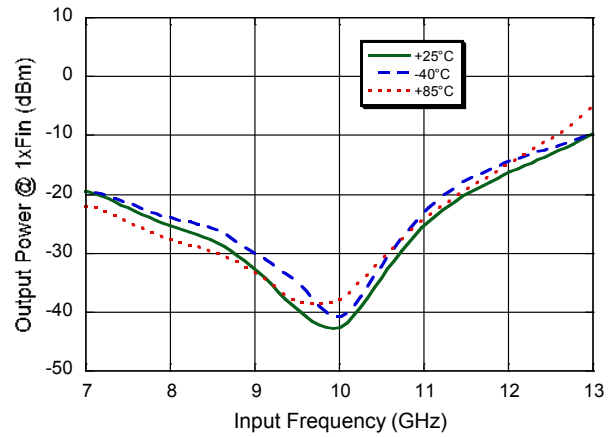

Output Power @ $1x F_{IN}$ and $2x F_{IN}$, $P_{IN} = -5\text{ to }+5\text{ dBm}$

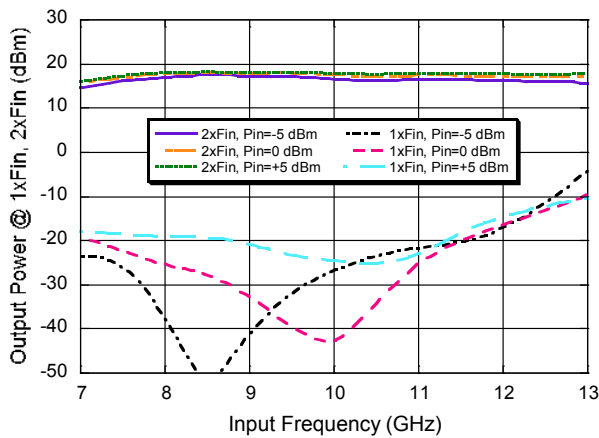

Supply Current

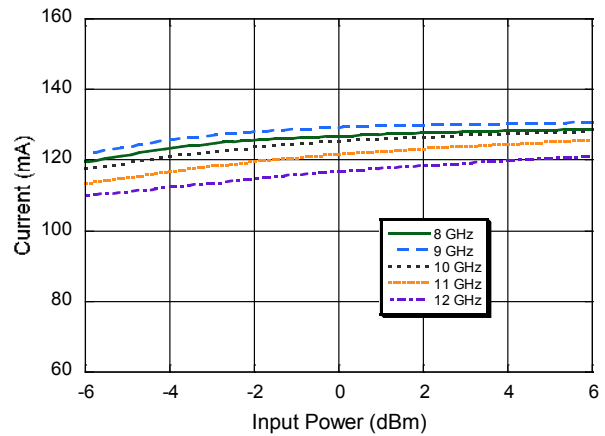

Input Return Loss

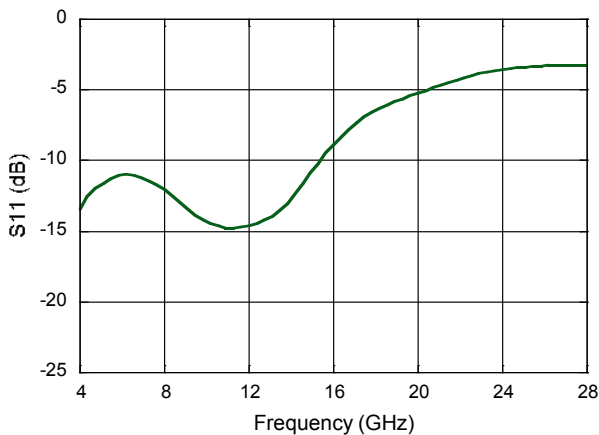

Output Return Loss

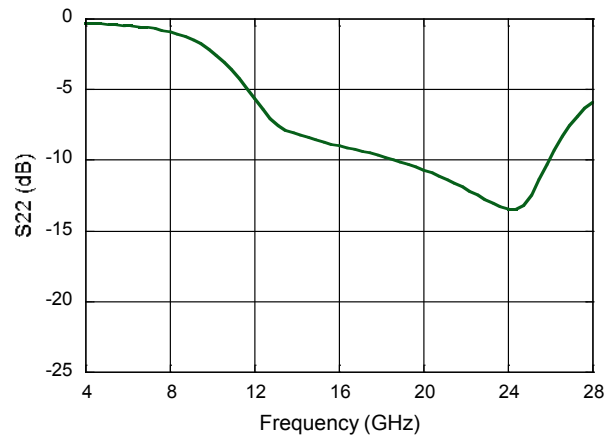

Lead-Free 3 mm 16-Lead PQFN[†]

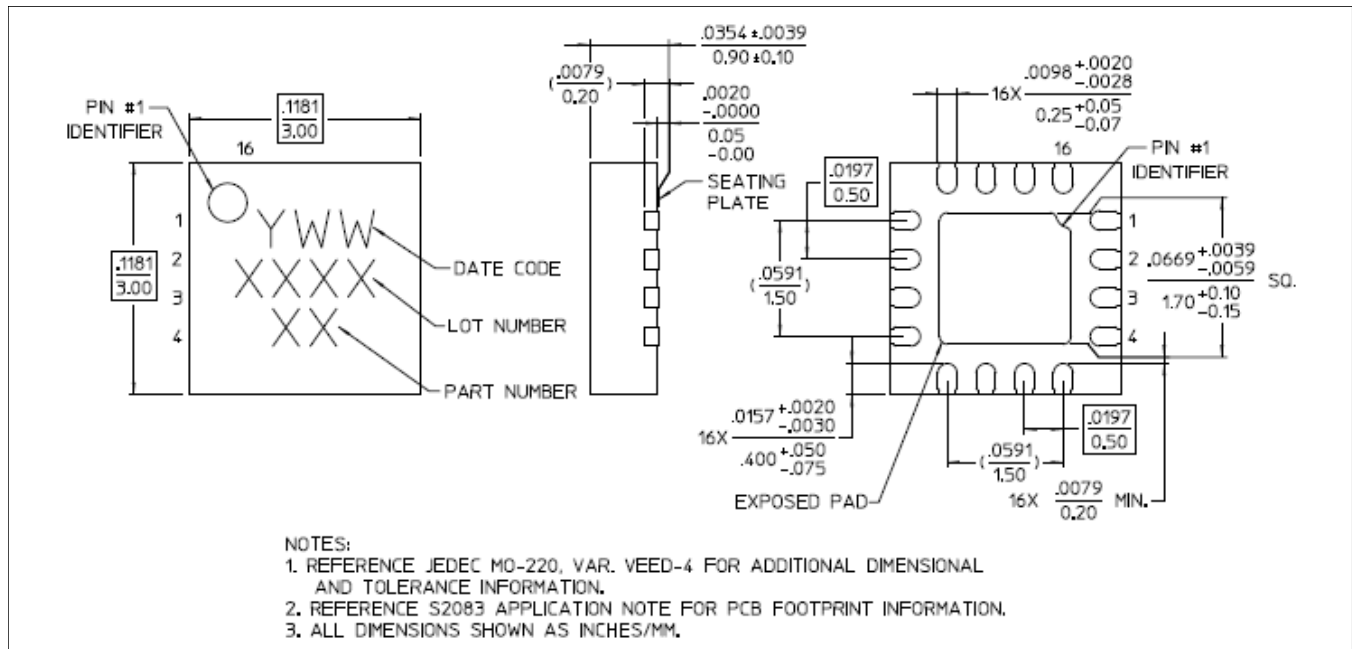

[†] Reference Application Note S2083 for lead-free solder reflow recommendations.
Meets JEDEC moisture sensitivity level 1 requirements.
Plating is 100% matte tin plating over copper

M/A-COM Technology Solutions Inc. All rights reserved.

Information in this document is provided in connection with M/A-COM Technology Solutions Inc ("MACOM") products. These materials are provided by MACOM as a service to its customers and may be used for informational purposes only. Except as provided in MACOM's Terms and Conditions of Sale for such products or in any separate agreement related to this document, MACOM assumes no liability whatsoever. MACOM assumes no responsibility for errors or omissions in these materials. MACOM may make changes to specifications and product descriptions at any time, without notice. MACOM makes no commitment to update the information and shall have no responsibility whatsoever for conflicts or incompatibilities arising from future changes to its specifications and product descriptions. No license, express or implied, by estoppel or otherwise, to any intellectual property rights is granted by this document.

THESE MATERIALS ARE PROVIDED "AS IS" WITHOUT WARRANTY OF ANY KIND, EITHER EXPRESS OR IMPLIED, RELATING TO SALE AND/OR USE OF MACOM PRODUCTS INCLUDING LIABILITY OR WARRANTIES RELATING TO FITNESS FOR A PARTICULAR PURPOSE, CONSEQUENTIAL OR INCIDENTAL DAMAGES, MERCHANTABILITY, OR INFRINGEMENT OF ANY PATENT, COPYRIGHT OR OTHER INTELLECTUAL PROPERTY RIGHT. MACOM FURTHER DOES NOT WARRANT THE ACCURACY OR COMPLETENESS OF THE INFORMATION, TEXT, GRAPHICS OR OTHER ITEMS CONTAINED WITHIN THESE MATERIALS. MACOM SHALL NOT BE LIABLE FOR ANY SPECIAL, INDIRECT, INCIDENTAL, OR CONSEQUENTIAL DAMAGES, INCLUDING WITHOUT LIMITATION, LOST REVENUES OR LOST PROFITS, WHICH MAY RESULT FROM THE USE OF THESE MATERIALS.

MACOM products are not intended for use in medical, lifesaving or life sustaining applications. MACOM customers using or selling MACOM products for use in such applications do so at their own risk and agree to fully indemnify MACOM for any damages resulting from such improper use or sale.