



Chipsmall Limited consists of a professional team with an average of over 10 year of expertise in the distribution of electronic components. Based in Hongkong, we have already established firm and mutual-benefit business relationships with customers from,Europe,America and south Asia,supplying obsolete and hard-to-find components to meet their specific needs.

With the principle of “Quality Parts,Customers Priority,Honest Operation,and Considerate Service”,our business mainly focus on the distribution of electronic components. Line cards we deal with include Microchip,ALPS,ROHM,Xilinx,Pulse,ON,Everlight and Freescale. Main products comprise IC,Modules,Potentiometer,IC Socket,Relay,Connector.Our parts cover such applications as commercial,industrial, and automotives areas.

We are looking forward to setting up business relationship with you and hope to provide you with the best service and solution. Let us make a better world for our industry!



Contact us

Tel: +86-755-8981 8866 Fax: +86-755-8427 6832

Email & Skype: info@chipsmall.com Web: www.chipsmall.com

Address: A1208, Overseas Decoration Building, #122 Zhenhua RD., Futian, Shenzhen, China



Features

- Conversion Gain:
 - $T_x = 3$ dB
 - $R_x = 11$ dB
- Receive:
 - Noise Figure = 3 dB
 - IIP3 = +5 dBm
- Transmit: IM3 = -40 dBc @ 0 dBm
- LO: 8 - 10 GHz & 0 dBm Drive
- Wide IF Bandwidth = 0.1 - 6.0 GHz
- Single 5 Volt DC Bias, 180 mA
- Lead-Free 4 mm 24-lead PQFN Package
- Halogen-Free "Green" Mold Compound
- RoHS* Compliant and 260°C Reflow Compatible

Description

The MAMF-011024 is a 21 - 27 GHz transceiver IC. It integrates an LNA, PA, T_x/R_x switch, bi-directional mixer, filtering, and LO frequency x2 multiplier with amplification. This device is assembled in a lead-free 4 mm 24 lead PQFN surface mount plastic package.

This transceiver operates either in receive or in transmit TDD (Time Division Duplex) mode. Receive and transmit circuitry can be turned off during transmit and receive, respectively. The T_x/R_x switch can be operated independently of the power up timing. It is powered from a single positive 5 V bias.

The MAMF-011024 is ideally suited for unlicensed 24 GHz ISM band applications.

Ordering Information^{1,2}

Part Number	Package
MAMF-011024 -TR0500	500 piece reel
MAMF-011024 -SMB	Sample Test Board

1. Reference Application Note M513 for reel size information.
2. All sample boards include 3 loose parts.

*Restrictions on Hazardous Substances,
European Union Directive 2011/65/EU.

Functional Schematic

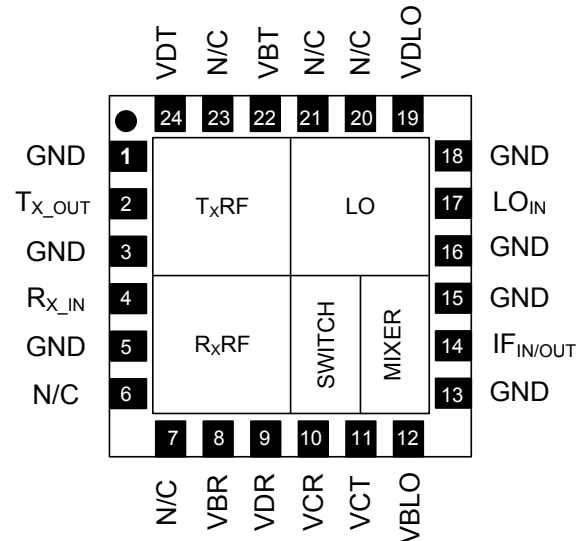

Pin Configuration³

Pin No.	Description	Pin No.	Description
1	Ground	13	Ground
2	Transmit Output	14	IF Input / Output
3	Ground	15	Ground
4	Receive Input	16	Ground
5	Ground	17	LO Input
6	No Connection	18	Ground
7	No Connection	19	LO Drain Voltage
8	R_x Bias Adjust	20	No Connection
9	R_x Drain Voltage	21	No Connection
10	R_x Switch Control	22	T_x Bias Adjust
11	T_x Switch Control	23	No Connection
12	LO Bias Adjust	24	T_x Drain Voltage
		25 ⁴	Ground

3. MACOM recommends connecting all "No Connection" pins to ground.
4. The exposed pad centered on the package bottom must be connected to RF, DC and thermal ground.

Electrical Specifications: $T_A = 25^\circ\text{C}$, $R_F = 24\text{ GHz}$, $I_F = 5.6\text{ GHz}$, $L_O = 9.2\text{ GHz}$, 0 dBm , $Z_0 = 50\ \Omega$, $V_{DT} = V_{DR} = V_{DLO} = 5\text{ V}$, Control / Bias Adjust Voltages⁵ = $0 / 5\text{ V}$

Parameter	Test Conditions	Units	Min.	Typ.	Max.
LO: Drive Power	—	dBm	—	0	—
LO: Return Loss	—	dB	—	12	—
R _X : Down Conversion Gain	—	dB	9	11	—
R _X : Noise Figure	—	dB	—	3	—
R _X : Return Loss	—	dB	—	11	—
R _X : Input IP3	—	dBm	—	+5	—
R _X : LO Isolation	LO to IF port LO Frequency 2xLO Frequency 3xLO Frequency	dB	—	22 33 55	—
T _X : Up Conversion Gain	—	dB	1	3	—
T _X : Output Noise	—	dBm/Hz	—	-85	—
T _X : Return Loss	—	dB	—	15	—
T _X : Output IM3	+5 dBm P _{OUT}	dBc	—	-40	—
T _X : LO Isolation	LO to T _X port LO Frequency 2xLO Frequency 3xLO Frequency	dB	—	48 20 25	—
IF: Return Loss	—	dB	—	7	—
Isolation	T _X Mode, R _X to IF R _X Mode, T _X to IF	dB	—	69 58	—
Current (sum of all DC currents)	T _X Mode R _X Mode Standby Mode	mA	110 120 —	150 160 <1	170 180 —

5. See Truth Table.

Absolute Maximum Ratings^{6,7}

Parameter	Absolute Maximum
Input Power (R _x)	+15 dBm
Input Power (LO, IF)	+10 dBm
Voltage	6 V
Junction Temperature	150°C
Operating Temperature	-40°C to +85°C
Storage Temperature	-65°C to +150°C

6. Exceeding any one or combination of these limits may cause permanent damage to this device.
7. MACOM does not recommend sustained operation near these survivability limits.

Handling Procedures

Please observe the following precautions to avoid damage:

Static Sensitivity

Gallium Arsenide Integrated Circuits are sensitive to electrostatic discharge (ESD) and can be damaged by static electricity. Proper ESD control techniques should be used when handling these devices.

Truth Table

Mode / Pin	VBLO (V)	VBT (V)	VBR (V)	VCT (V)	VCR (V)
R _x	+5	0	+5	0	+5
T _x	+5	+5	0	+5	0
Standby	0	0	0	0	0

The MAMF-011024 is designed to be easy to use yet high performance. The ultra small size and simple bias allow easy placement on any system board. It requires no matching or external tuning elements; all RF ports are matched to 50 Ω .

The MAMF-011024 requires only a single +5 V power supply to operate. All VDX and VBX lines can be tied to the +5 V (with appropriate bypass capacitors) for simple operation. See the Truth Table for T_x/R_x/Standby modes of operation.

Evaluation Board

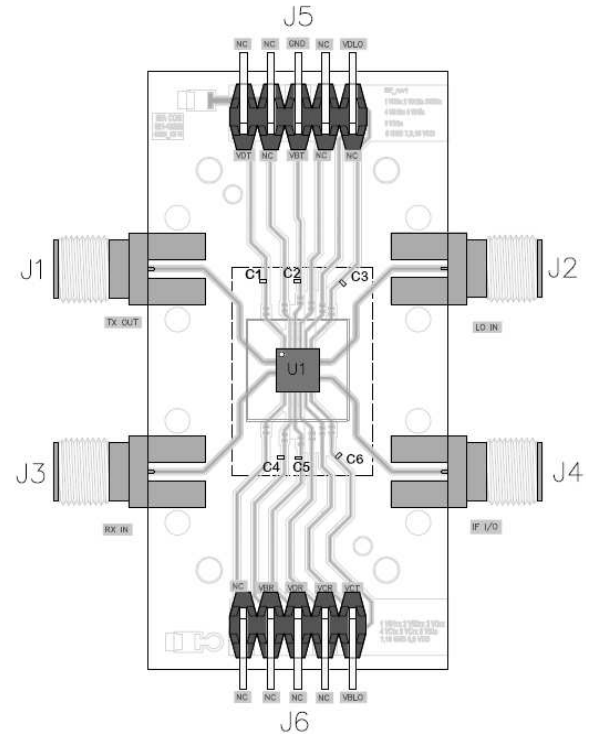

Parts List

Component	Value	Package
C1 - C6	0.22 μ F	0201

Application Schematic

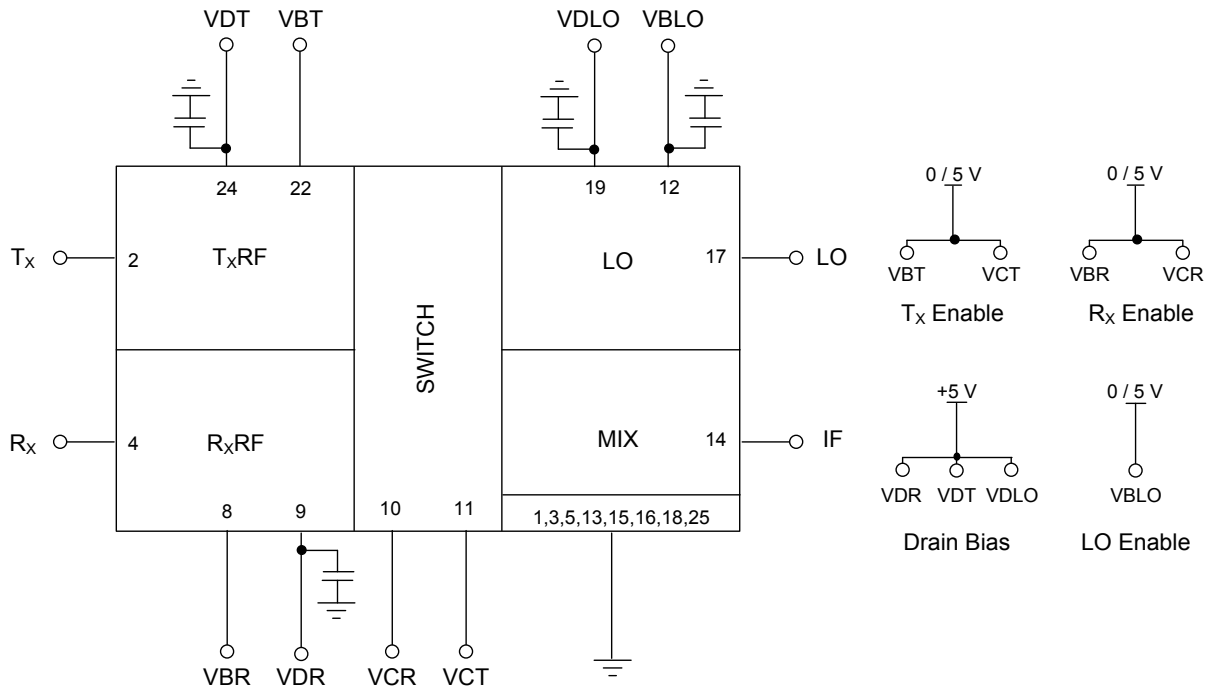

R_x (Receive) Typical Performance for Down-Conversion

Gain

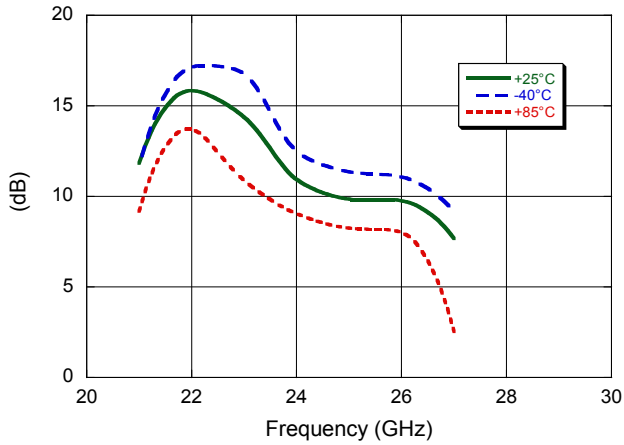

Input IP3

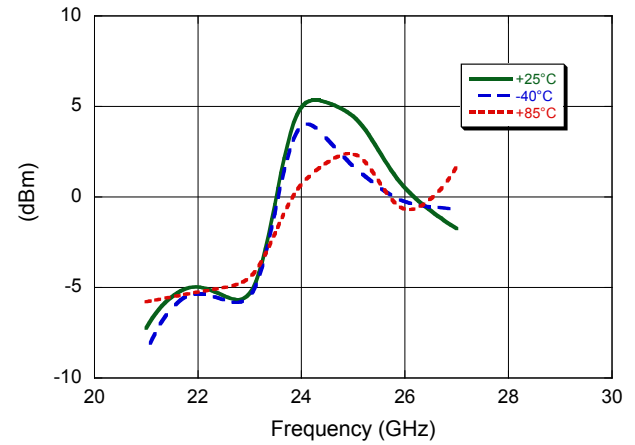

Noise Figure

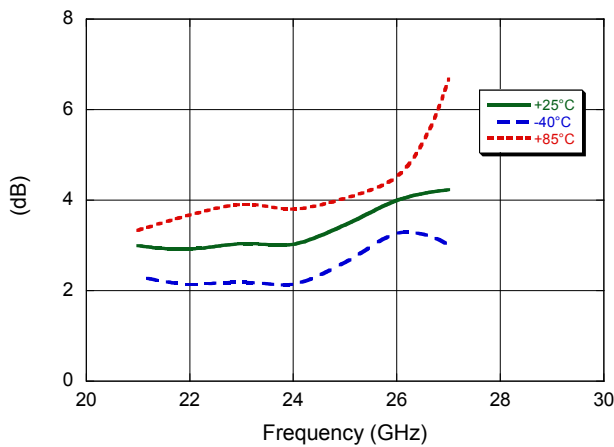

Input IP3 vs. IF Frequency, LO = 0 dBm

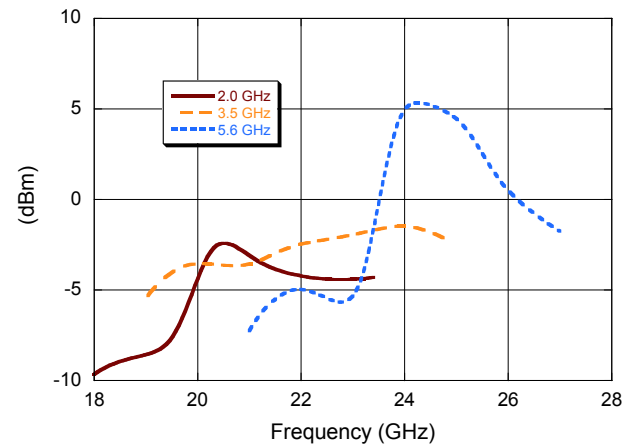

Isolation LO to IF

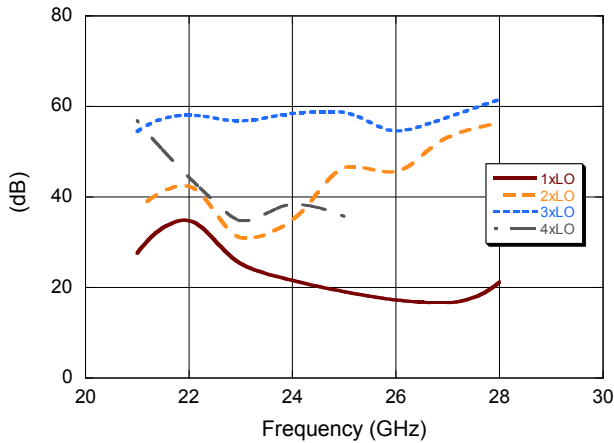

Conversion Gain vs. IF Frequency

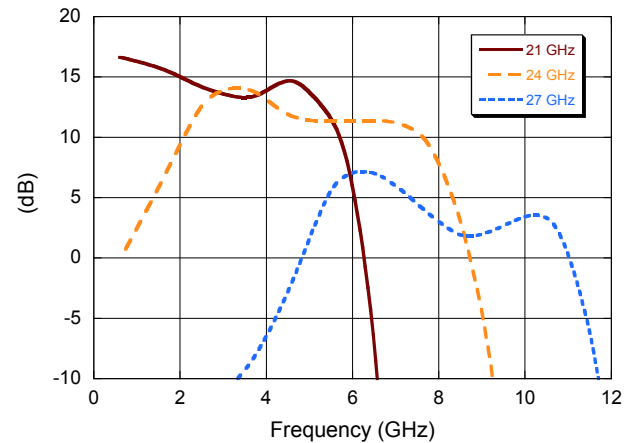

T_x (Transmit) Typical Performance for Up-Conversion

Gain

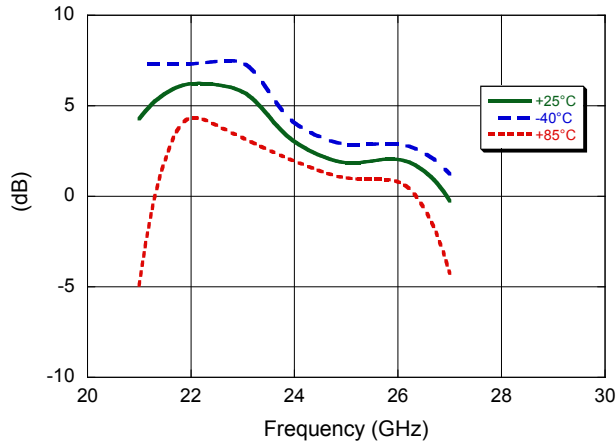

Output IM3 @ 5 dBm

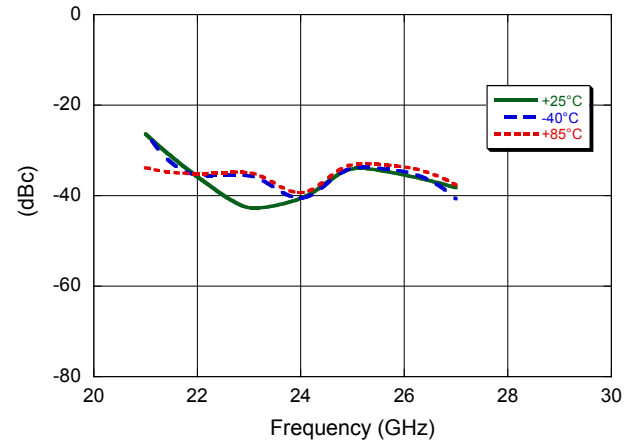

Output Noise

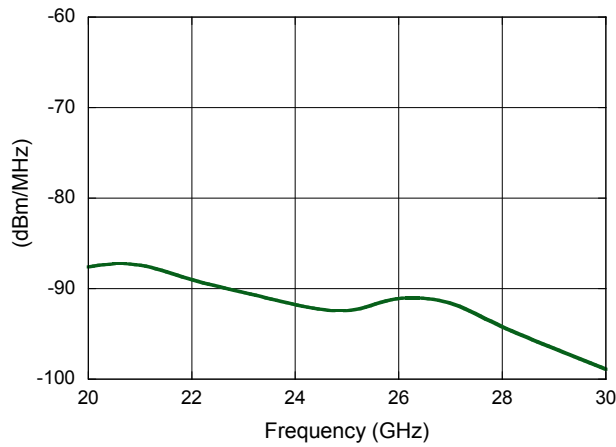

Output IM3 @ LO Input Power

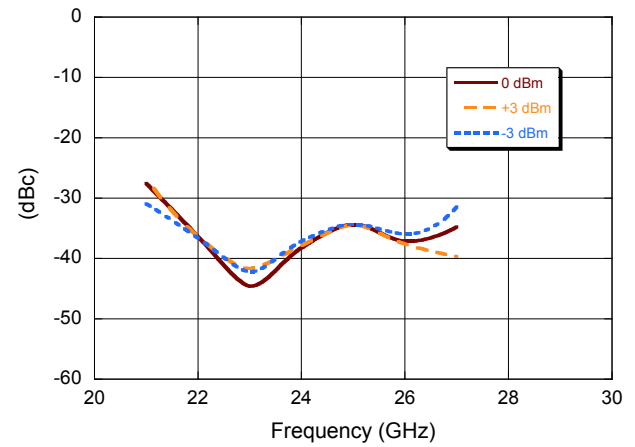

Isolation LO to T_x

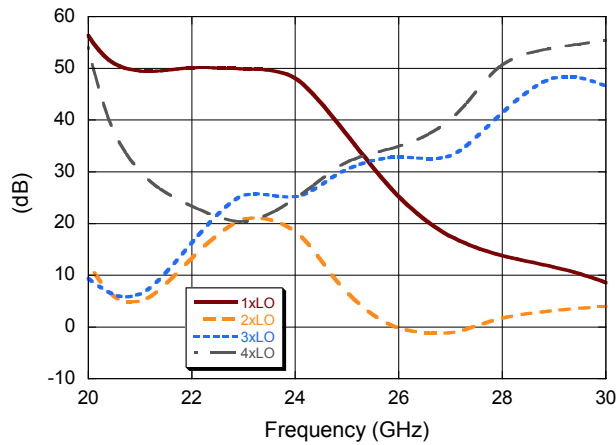

Conversion Gain vs. IF Frequency

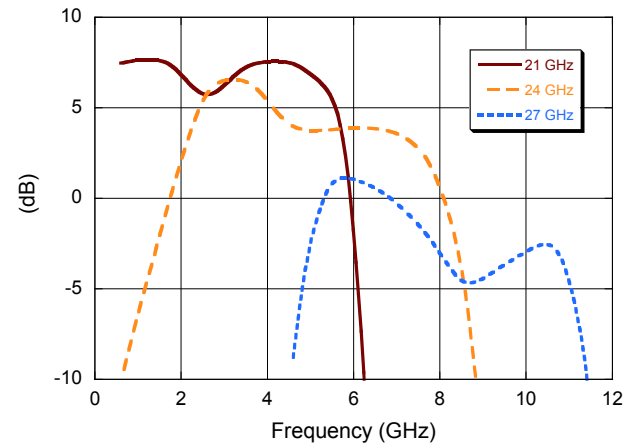

Typical Performance

R_x/T_x Input Return Loss

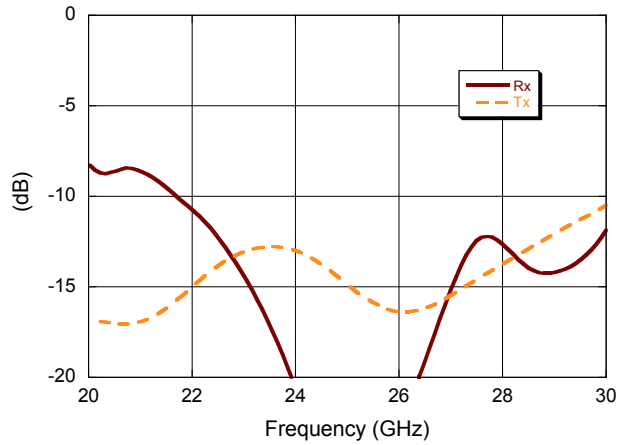

LO Return Loss vs. LO Frequency

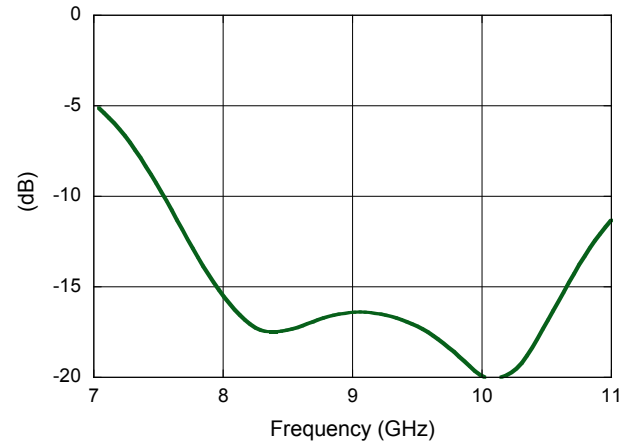

IF Return Loss vs. IF Frequency

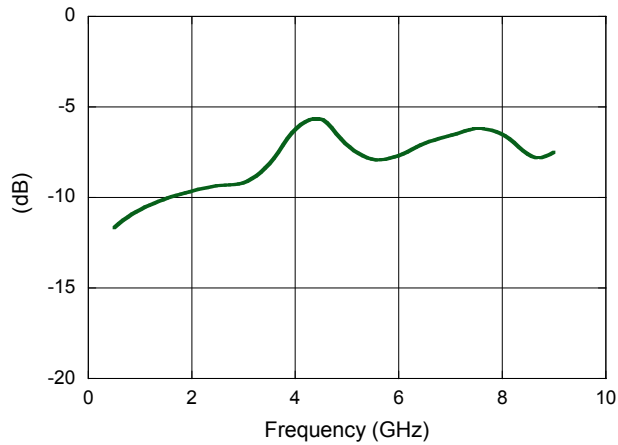

T_x Output Spectrum

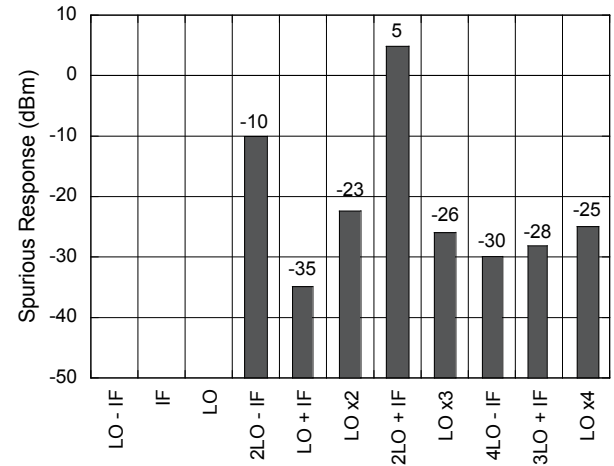

R_x Conversion Gain vs. LO Drive

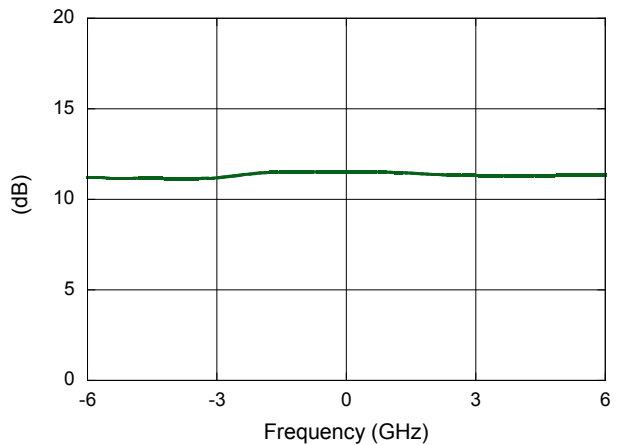

T_x Conversion Gain vs. LO Drive

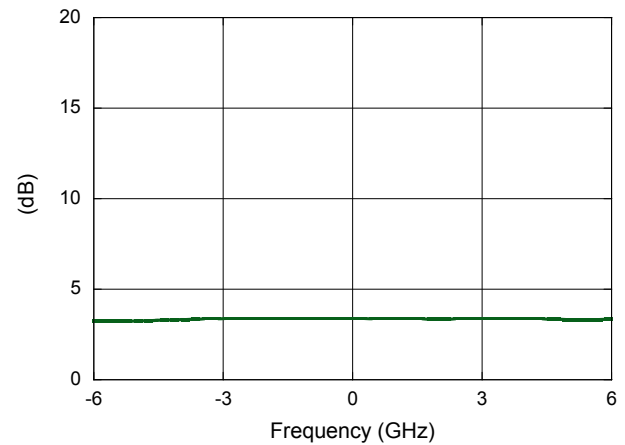

Lead-Free 4 mm 24-Lead PQFN[†]

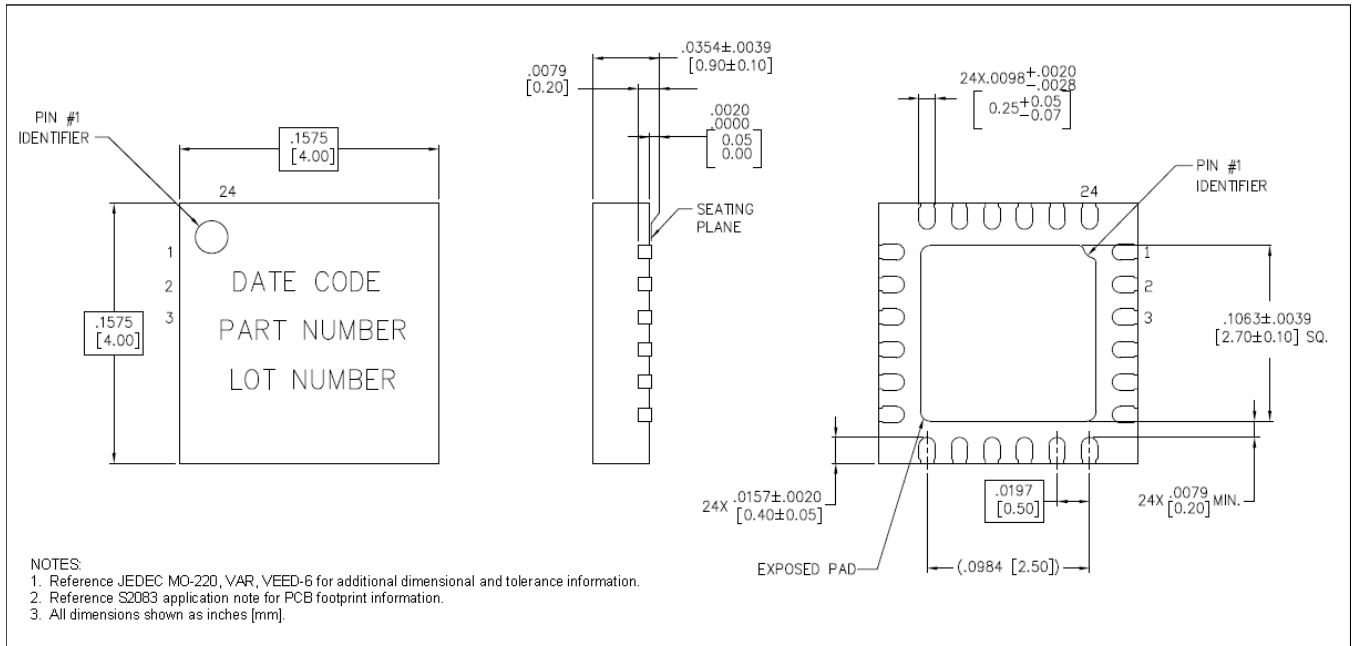

[†] Reference Application Note S2083 for lead-free solder reflow recommendations.
 Meets JEDEC moisture sensitivity level 1 requirements.
 Plating is NiPdAuAg.