



Chipsmall Limited consists of a professional team with an average of over 10 year of expertise in the distribution of electronic components. Based in Hongkong, we have already established firm and mutual-benefit business relationships with customers from,Europe,America and south Asia,supplying obsolete and hard-to-find components to meet their specific needs.

With the principle of "Quality Parts,Customers Priority,Honest Operation,and Considerate Service",our business mainly focus on the distribution of electronic components. Line cards we deal with include Microchip,ALPS,ROHM,Xilinx,Pulse,ON,Everlight and Freescale. Main products comprise IC,Modules,Potentiometer,IC Socket,Relay,Connector.Our parts cover such applications as commercial,industrial, and automotives areas.

We are looking forward to setting up business relationship with you and hope to provide you with the best service and solution. Let us make a better world for our industry!



Contact us

Tel: +86-755-8981 8866 Fax: +86-755-8427 6832

Email & Skype: info@chipsmall.com Web: www.chipsmall.com

Address: A1208, Overseas Decoration Building, #122 Zhenhua RD., Futian, Shenzhen, China



MAGX-001214-500L00

MAGX-001214-500L0S

GaN on SiC HEMT Pulsed Power Transistor
500 W Peak, 1200-1400 MHz, 300 μ s Pulse, 10% Duty

Rev. V2

Features

- GaN on SiC D-Mode Transistor Technology
- Internally Matched
- Common-Source Configuration
- Broadband Class AB Operation
- RoHS* Compliant and 260°C Reflow Compatible
- +50 V Typical Operation
- MTTF = 600 years ($T_J < 200^\circ\text{C}$)

Applications

- L-Band pulsed radar

Description

The MAGX-001214-500L00 is a gold-metalized matched Gallium Nitride (GaN) on Silicon Carbide (SiC) RF power transistor optimized for pulsed L-Band radar applications. Using state of the art wafer fabrication processes, these high performance transistors provide high gain, efficiency, bandwidth, and ruggedness over a wide bandwidth for today's demanding application needs. High breakdown voltages allow for reliable and stable operation under more extreme mismatch load conditions compared with older semiconductor technologies.

MAGX-001214-500L00

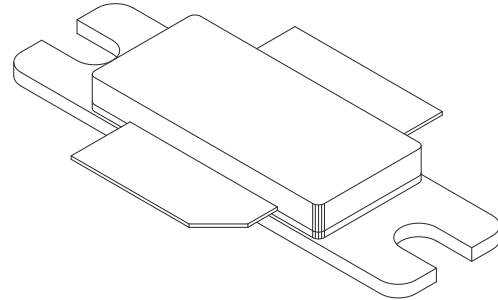

MAGX-001214-500L0S

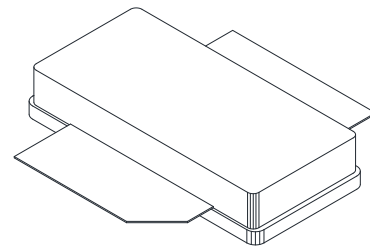

Ordering Information

Part Number	Description
MAGX-001214-500L00	Flanged
MAGX-001214-500L0S	Flangeless
MAGX-001214-SB3PPR	1.2 - 1.4 GHz Evaluation Board

* Restrictions on Hazardous Substances, European Union Directive 2002/95/EC.

MAGX-001214-500L00

MAGX-001214-500L0S



GaN on SiC HEMT Pulsed Power Transistor
500 W Peak, 1200-1400 MHz, 300 μ s Pulse, 10% Duty

Rev. V2

Typical RF Performance under standard operating conditions, $P_{OUT} = 500$ W (Peak)

Freq. (MHz)	P_{IN} (W)	Gain (dB)	I_D (A)	Eff. (%)	RL (dB)	Droop (dB)	+1dB OD (W)
1200	5.15	19.86	17.7	56.2	-12.7	0.29	568
1250	5.35	19.69	16.7	59.5	-10.3	0.30	561
1300	5.69	19.43	17.2	57.9	-10.9	0.33	554
1350	5.86	19.31	17.9	55.7	-15.3	0.36	547
1400	5.85	19.22	18.1	54.8	-17.5	0.38	549

Electrical Specifications: Freq. = 1200 - 1400 MHz, $I_{DQ} = 400$ mA, $T_A = 25^\circ\text{C}$

Parameter	Test Conditions	Symbol	Min.	Typ.	Max.	Units
RF Functional Tests: $V_{DD} = 50$ V; 300 μs / 10%						
Input Power	$P_{OUT} = 500$ W Peak (50 W avg.)	P_{IN}	-	6	8.9	Wpk
Power Gain	$P_{OUT} = 500$ W Peak (50 W avg.)	G_P	17.5	19.2	-	dB
Drain Efficiency	$P_{OUT} = 500$ W Peak (50 W avg.)	η_D	50	56	-	%
Pulse Droop	$P_{OUT} = 500$ W Peak (50 W avg.)	Droop	-	0.4	0.7	dB
Load Mismatch Stability	$P_{OUT} = 500$ W Peak (50 W avg.)	VSWR-S	-	3:1	-	-
Load Mismatch Tolerance	$P_{OUT} = 500$ W Peak (50 W avg.)	VSWR-T	-	5:1	-	-
Extended Pulse Width Conditions: $V_{DD} = 42$ V; 1.0 ms / 10%; (typical RF data)						
Input Power	$P_{OUT} = 375$ W Peak (37.5 W avg.)	P_{IN}	-	5.3	-	Wpk
Power Gain	$P_{OUT} = 375$ W Peak (37.5 W avg.)	G_P	-	18.5	-	dB
Drain Efficiency	$P_{OUT} = 375$ W Peak (37.5 W avg.)	η_D	-	55	-	%

Electrical Characteristics: $T_A = 25^\circ\text{C}$

Parameter	Test Conditions	Symbol	Min.	Typ.	Max.	Units
DC Characteristics:						
Drain-Source Leakage Current	$V_{GS} = -8$ V, $V_{DS} = 175$ V	I_{DS}	-	1.0	30	mA
Gate Threshold Voltage	$V_{DS} = 5$ V, $I_D = 75$ mA	$V_{GS(TH)}$	-5	-3.1	-2	V
Forward Transconductance	$V_{DS} = 5$ V, $I_D = 17.5$ mA	G_M	12.5	19.2	-	S
Dynamic Characteristics:						
Input Capacitance	Not applicable - Input matched	C_{ISS}	N/A	N/A	N/A	pF
Output Capacitance	$V_{DS} = 50$ V, $V_{GS} = -8$ V, $F = 1$ MHz	C_{OSS}	-	55	-	pF
Reverse Transfer Capacitance	$V_{DS} = 50$ V, $V_{GS} = -8$ V, $F = 1$ MHz	C_{RSS}	-	5.5	-	pF

MAGX-001214-500L00

MAGX-001214-500L0S

GaN on SiC HEMT Pulsed Power Transistor
500 W Peak, 1200-1400 MHz, 300 μ s Pulse, 10% Duty

Rev. V2

Absolute Maximum Ratings^{1,2,3,4}

Parameter	Limit
Supply Voltage (V_{DD})	+65 V
Supply Voltage (V_{GS})	-8 to -2 V
Supply Current ($I_{D_{MAX}}$)	21.5 A
Input Power (P_{IN})	P_{IN} (nominal) + 3 dB
Absolute Max. Junction/Channel Temp	200°C
Pulsed Power Dissipation at 85 °C	583 W
Thermal Resistance, ($T_J = 70$ °C) $V_{DD} = 50$ V, $I_{DQ} = 400$ mA, $P_{out} = 500$ W, 300 μ s Pulse / 10% Duty	0.30 °C/W
Operating Temp	-40 to +95°C
Storage Temp	-65 to +150°C
Mounting Temperature	See solder reflow profile
ESD Min. - Charged Device Model (CDM)	1300 V
ESD Min. - Human Body Model (HBM)	4000 V

1. Operation of this device above any one of these parameters may cause permanent damage.
2. Input Power Limit is +3 dB over nominal drive required to achieve $P_{OUT} = 500$ W.
3. Channel temperature directly affects a device's MTTF. Channel temperature should be kept as low as possible to maximize lifetime.
4. For saturated performance it recommended that the sum of $(3 \cdot V_{DD} + \text{abs}(V_{GS})) < 175$ V.

Test Fixture Impedances

F (MHz)	Z_{IF} (Ω)	Z_{OF} (Ω)
1200	1.2 - j1.2	1.8 + j0.5
1250	1.2 - j0.9	1.9 + j0.4
1300	1.3 - j0.6	2.0 + j0.3
1350	1.4 - j0.3	1.9 + j0.2
1400	1.6 + j0.0	1.7 + j0.1

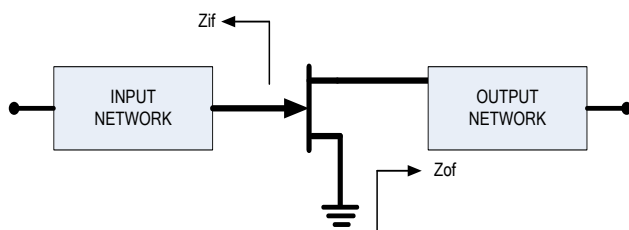

Correct Device Sequencing

Turning the device ON

1. Set V_{GS} to the pinch-off (V_P), typically -5 V.
2. Turn on V_{DS} to nominal voltage (50 V).
3. Increase V_{GS} until the I_{DS} current is reached.
4. Apply RF power to desired level.

Turning the device OFF

1. Turn the RF power off.
2. Decrease V_{GS} down to V_P .
3. Decrease V_{DS} down to 0 V.
4. Turn off V_{GS}

MAGX-001214-500L00 MAGX-001214-500L0S

GaN on SiC HEMT Pulsed Power Transistor
500 W Peak, 1200-1400 MHz, 300 μ s Pulse, 10% Duty

Rev. V2

Test Fixture Circuit Dimensions

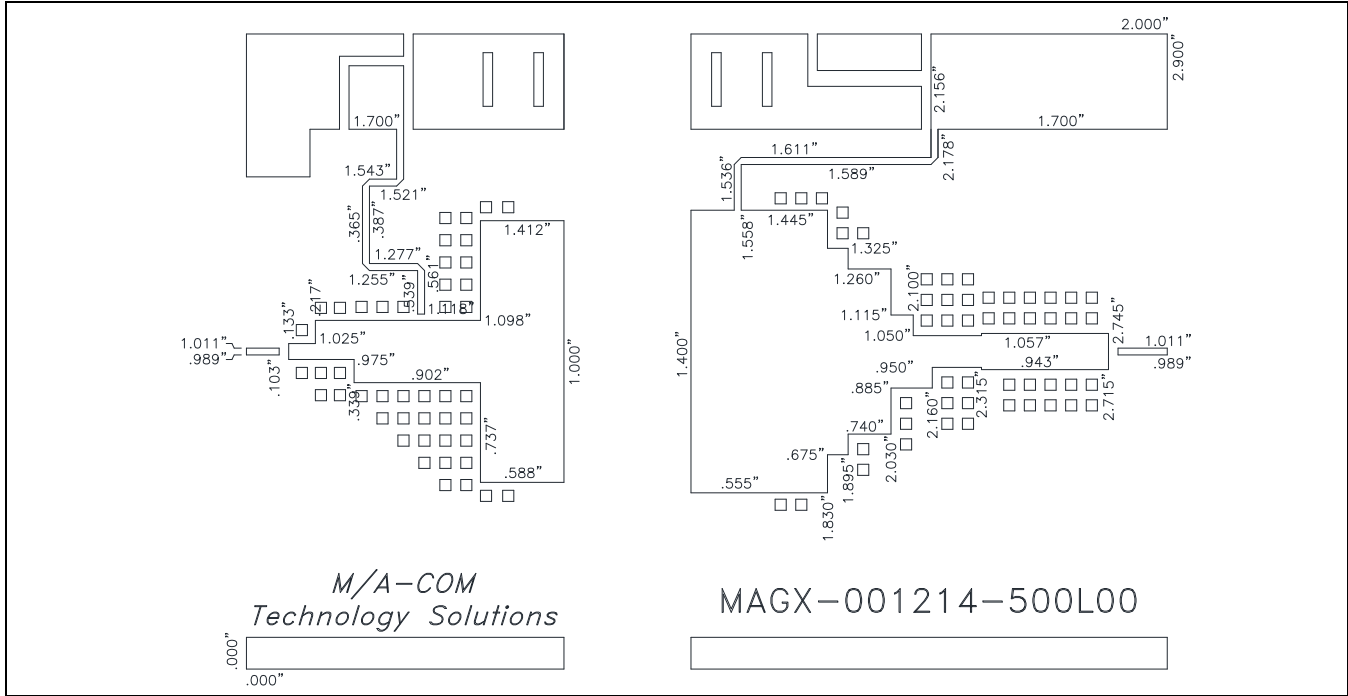

Test Fixture Assembly

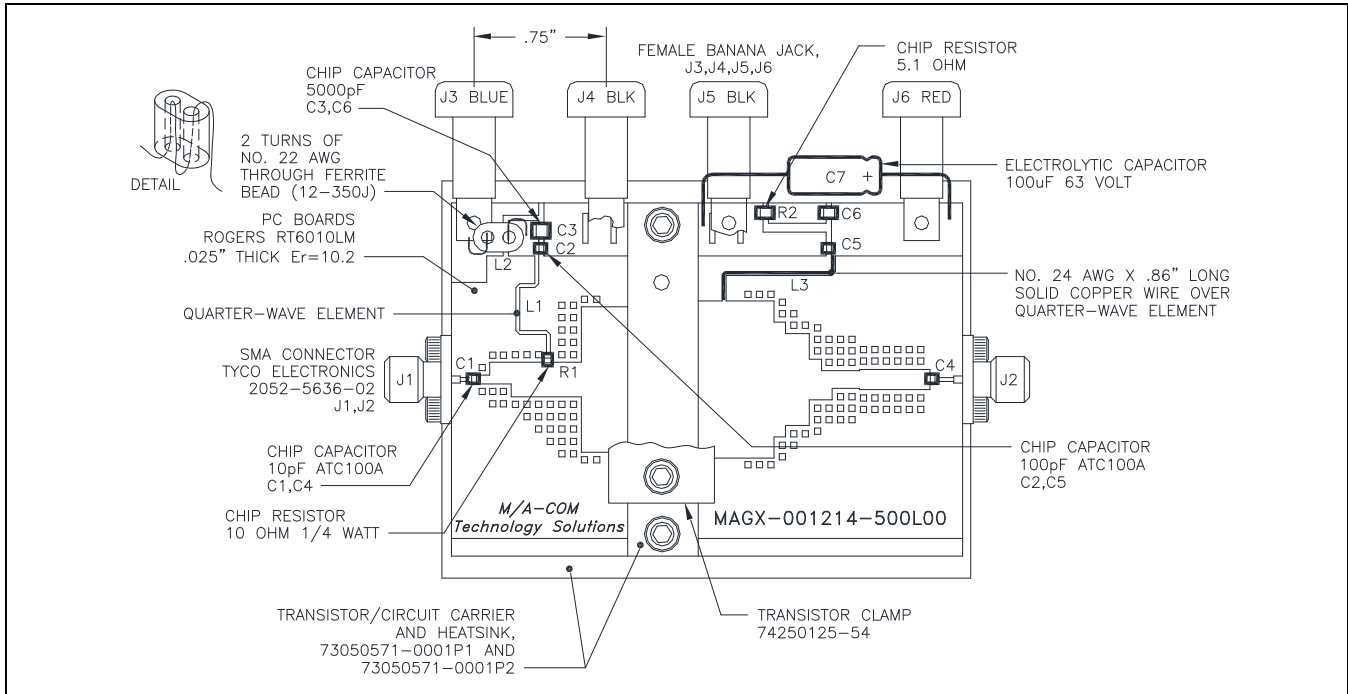

Contact factory for gerber file or additional circuit information.

MAGX-001214-500L00

MAGX-001214-500L0S



GaN on SiC HEMT Pulsed Power Transistor
 500 W Peak, 1200-1400 MHz, 300 μ s Pulse, 10% Duty

Rev. V2

RF Power Transfer Curve (Output Power Vs. Input Power)

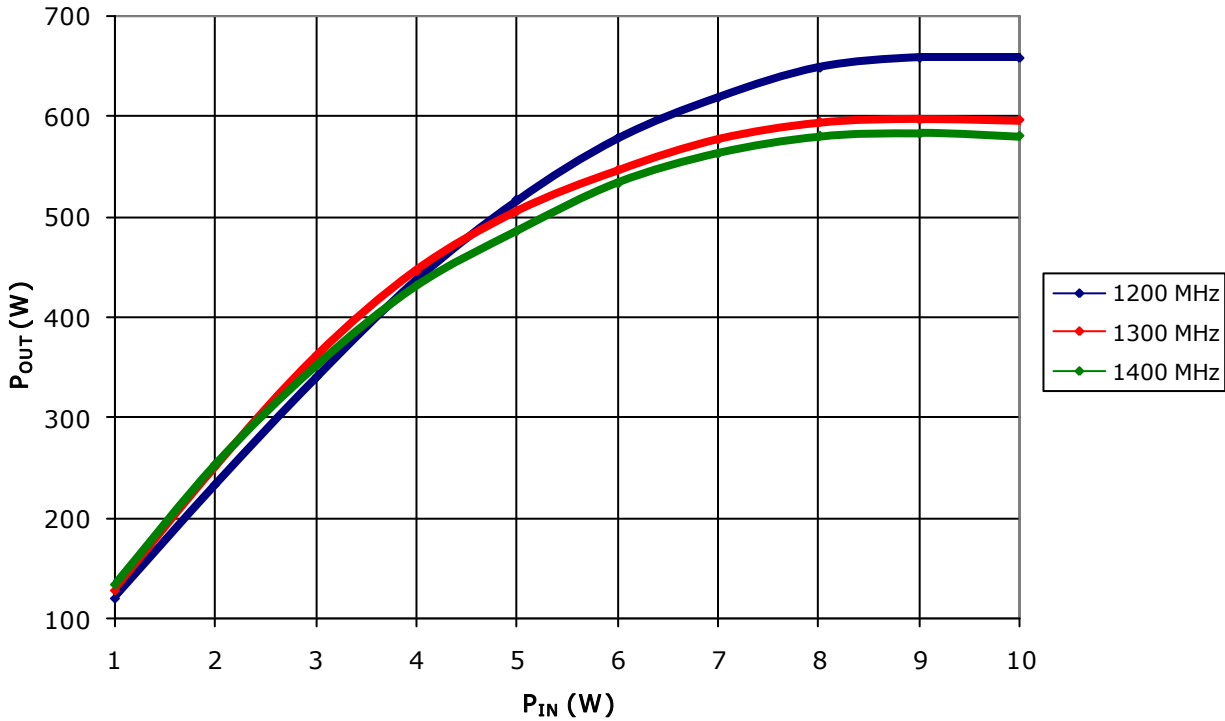

RF Power Transfer Curve (Drain Efficiency Vs. Output Power)

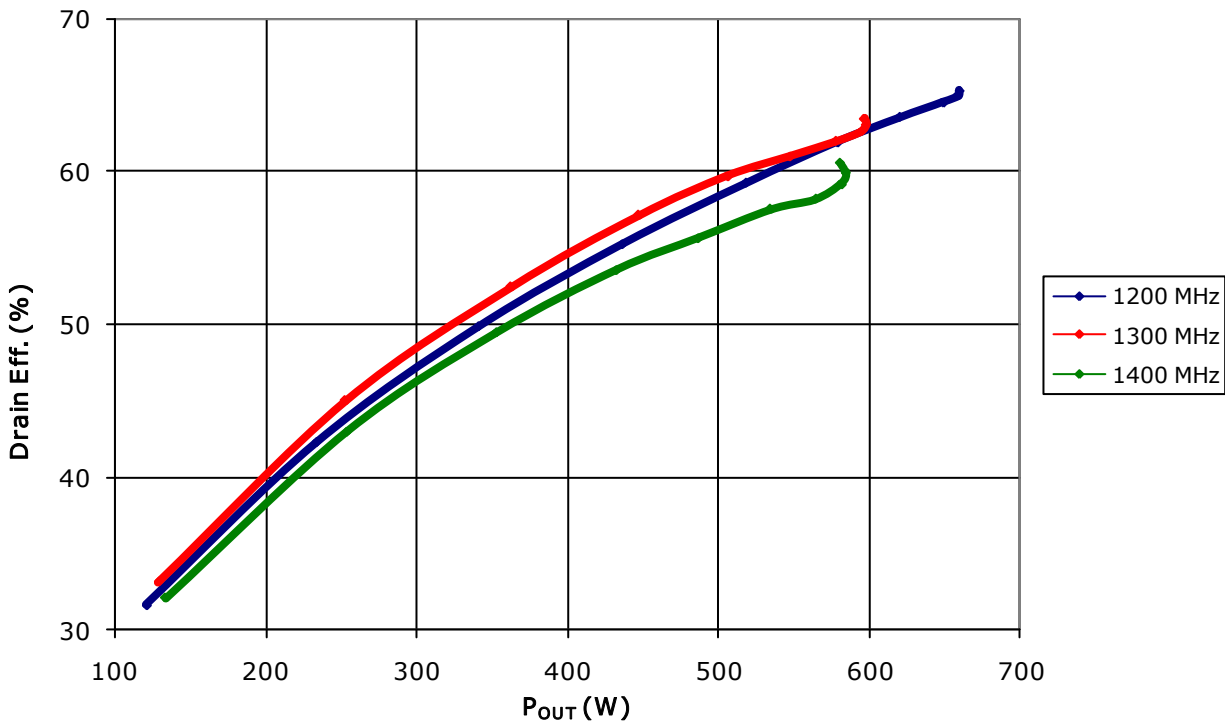

MAGX-001214-500L00

MAGX-001214-500L0S



GaN on SiC HEMT Pulsed Power Transistor
500 W Peak, 1200-1400 MHz, 300 μ s Pulse, 10% Duty

Rev. V2

Typical RF Data with 'extended pulse' conditions⁵:
1.0 ms Pulse, 10% Duty, $V_{DD} = 42$ V, $I_{DQ} = 400$ mA

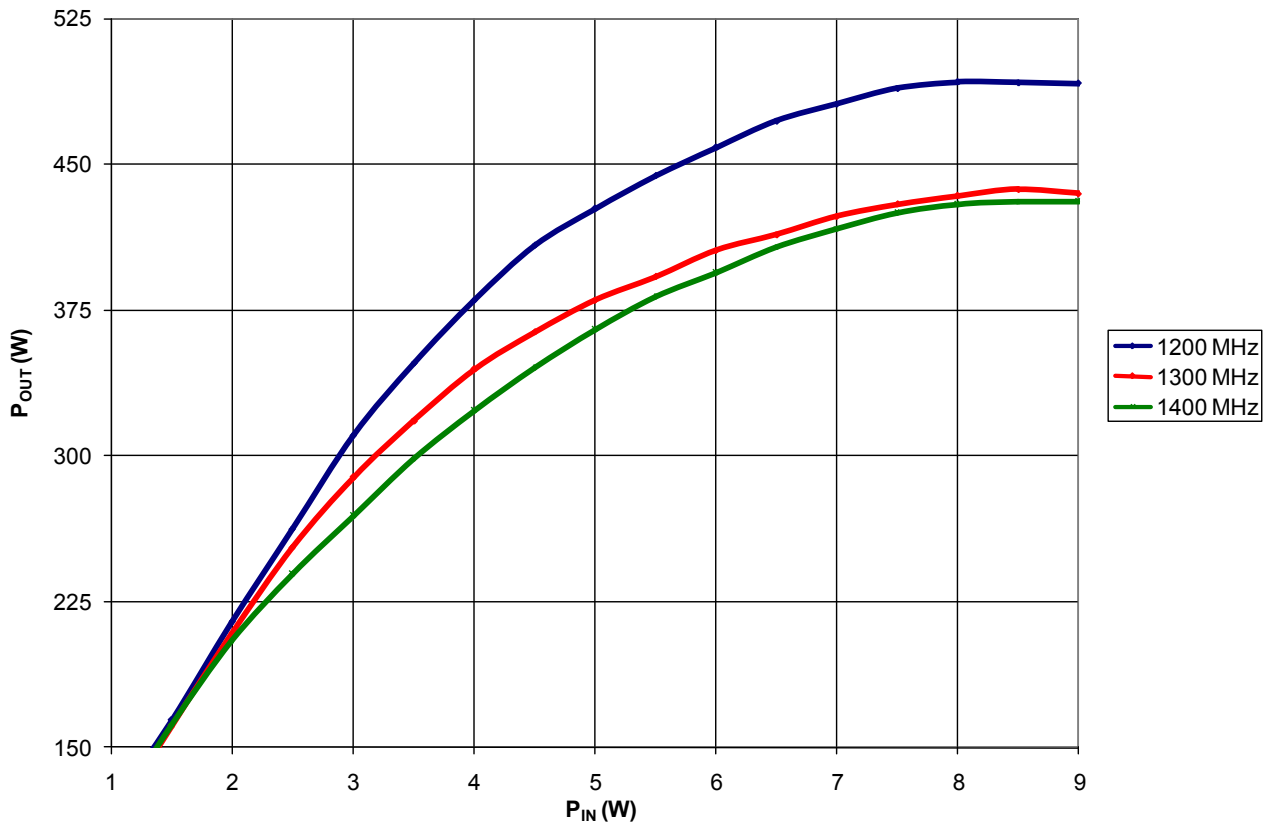

5. Drain Voltage and RF output power is de-rated to keep junction temperature within acceptable levels.

MAGX-001214-500L00

MAGX-001214-500L0S

GaN on SiC HEMT Pulsed Power Transistor
500 W Peak, 1200-1400 MHz, 300 μ s Pulse, 10% Duty

Rev. V2

Outline Drawing MAGX-002114-500L00

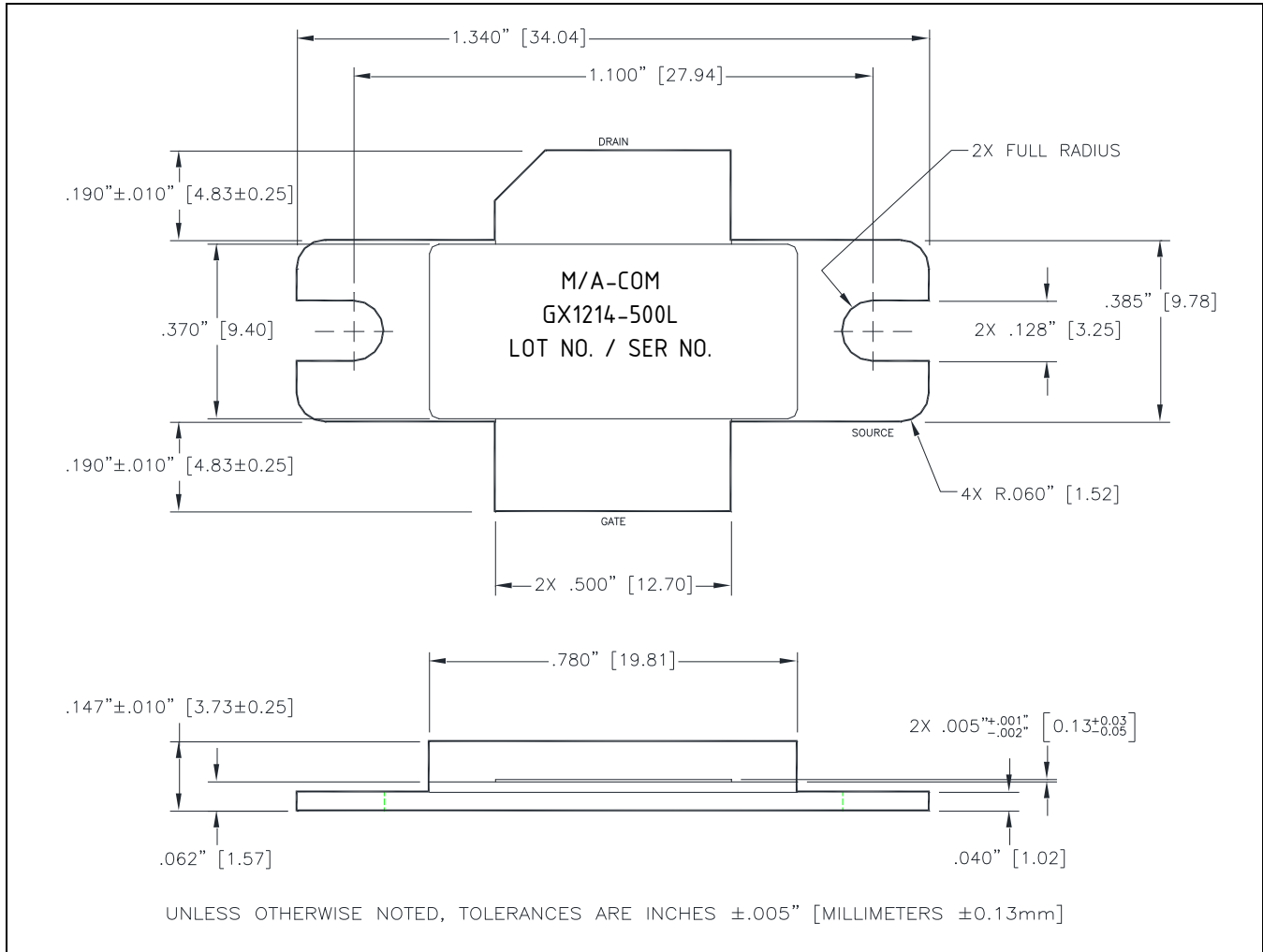

MAGX-001214-500L00

MAGX-001214-500L0S



GaN on SiC HEMT Pulsed Power Transistor
500 W Peak, 1200-1400 MHz, 300 μs Pulse, 10% Duty

Rev. V2

Outline Drawing MAGX-002114-500L0S

