



Chipsmall Limited consists of a professional team with an average of over 10 year of expertise in the distribution of electronic components. Based in Hongkong, we have already established firm and mutual-benefit business relationships with customers from,Europe,America and south Asia,supplying obsolete and hard-to-find components to meet their specific needs.

With the principle of “Quality Parts,Customers Priority,Honest Operation,and Considerate Service”,our business mainly focus on the distribution of electronic components. Line cards we deal with include Microchip,ALPS,ROHM,Xilinx,Pulse,ON,Everlight and Freescale. Main products comprise IC,Modules,Potentiometer,IC Socket,Relay,Connector.Our parts cover such applications as commercial,industrial, and automotives areas.

We are looking forward to setting up business relationship with you and hope to provide you with the best service and solution. Let us make a better world for our industry!



## Contact us

Tel: +86-755-8981 8866 Fax: +86-755-8427 6832

Email & Skype: info@chipsmall.com Web: www.chipsmall.com

Address: A1208, Overseas Decoration Building, #122 Zhenhua RD., Futian, Shenzhen, China



## L-Band 90 W 2-Stage Fully Matched GaN Module Surface Mount Laminate Package

Rev. V3

### Features

- Compact Size (14x24 mm<sup>2</sup>)
- GaN on SiC D-Mode Transistor Technology
- Fully Matched, De-Coupled DC and RF
- Typical Bias: 45 V, Class AB
- Intended for Pulsed RADAR Applications
- Output Power > 90 W, with 30 dB Gain and 60% Power Added Efficiency
- Up to 3 ms Pulse Width and 10% Duty Cycle
- MTTF = 600 years ( $T_J < 200^\circ\text{C}$ )
- Thermally Enhanced Laminate LGA Package
- RoHS\* Compliant. Lead Free Reflow Compatible
- MSL-3



### Description

The MAMG-001214-090PSM is a 2-stage GaN power module in a “True SMT” laminate package. The module is fully matched. Under pulsed conditions, it can deliver output power greater than 90 W, with 30 dB typical associated gain and 60% typical power added efficiency.

Flexible design allows for gate and/or drain pulsing. Additional features include a gate voltage sense port for use in temperature compensation or pulse droop compensation. The overall package size is very small, only 14x24 mm<sup>2</sup>. The module’s compact size, combined with excellent RF performance makes this product an ideal solution for pulsed RADAR applications where low cost, light weight and small size are the key.

### Functional Schematic

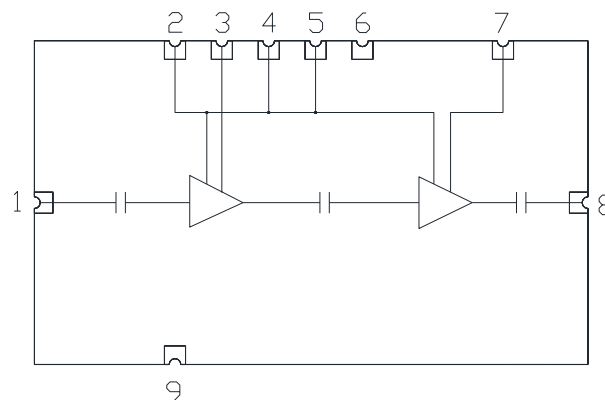

### Pin Configuration

Pin No.	Function
1	RF IN
2	VG <sup>3</sup>
3	VD1
4	NC <sup>4</sup>
5	VG sense <sup>5</sup>
6	Ground
7	VD2
8	RF OUT
9	NC <sup>4</sup>

3. One common gate voltage for both stages in the module.
4. Do not connect.
5. Do not connect to ground if not used.

### Ordering Information<sup>1</sup>

Part Number	Package
MAMG-001214-090PSM	Bulk Packaging
MAMG-0T1214-090PSM	100 Piece Reel
MAMG-L21214-090PSM	Evaluation Board <sup>2</sup>

1. Reference Application Note M513 for reel size information.
2. Includes one module surface-mounted onto board.

\* Restrictions on Hazardous Substances, European Union Directive 2002/95/EC.

## L-Band 90 W 2-Stage Fully Matched GaN Module Surface Mount Laminate Package

Rev. V3

### Electrical Specifications <sup>6</sup>

Parameter	Symbol	Min.	Typ.	Max.	Units
<b>RF FUNCTIONAL TESTS: Freq. = 1200-1400 MHz, V<sub>DD</sub> = 45 V, I<sub>DQ</sub> = 300 mA, T<sub>A</sub> = 25°C, Z<sub>L</sub> = 50 Ω, Pulse Width = 1 ms, Duty Cycle = 10%, P<sub>IN</sub> = 19 dBm</b>					
Peak Output Power <sup>7</sup>	P <sub>OUT</sub>	49.1	49.8	-	dBm
		82	99	-	W
Power Gain	G <sub>P</sub>	30.1	30.9	-	dB
Power Added Efficiency	PAE	56	60	-	%
Pulse Droop <sup>8</sup>	Droop	-	0.3	0.4	dB
2 <sup>nd</sup> Harmonic	2F0	-	-40	-	dBc
3 <sup>rd</sup> Harmonic	3F0	-	-52	-	dBc
Load Mismatch Stability	VSWR-S	-	5:1	-	-
Load Mismatch Tolerance	VSWR-T	-	6:1	-	-

6. Typical RF performance measured in RF evaluation board (see layout on page 4).

7. Peak output power measured at center of pulse.

8. Pulse droop measured between 10% and 90% of pulse.

### Absolute Maximum Ratings <sup>9,10,11,12,13</sup>

Parameter	Absolute Maximum
Input Power	26 dBm
Drain Supply Voltage (pulsed), V <sub>DD</sub>	+55 V
Gate Supply Voltage Range, V <sub>GG</sub>	-9 V to -2.5 V
Supply Current, I <sub>DD</sub>	4.0 A
Power Dissipation, Pulsed Mode @ 85°C	80 W
Junction Temperature <sup>14</sup>	200 °C
Operating Temperature	-40°C to +85°C
Storage Temperature	-65°C to +150°C
ESD Maximum - Human Body Model (HBM)	600 V
ESD Maximum - Charged Device Model (CDM)	300 V

9. Exceeding any one or combination of these limits may cause permanent damage to this device.

10. MACOM does not recommend sustained operation near these survivability limits.

11. For saturated performance it is recommended that the sum of  $(3 * V_{DD} + \text{abs}(V_{GG})) \leq 175 \text{ V}$ .

12. CW operation is not recommended.

13. Operating at nominal conditions with T<sub>J</sub> ≤ 200°C will ensure MTTF > 1 x 10<sup>6</sup> hours. Junction temperature directly affects device MTTF and should be kept as low as possible to maximize lifetime.

14. Junction Temperature (T<sub>J</sub>) = T<sub>C</sub> + Θ<sub>JC</sub> \* ((V \* I) - (P<sub>OUT</sub> - P<sub>IN</sub>)).

Typical Transient Thermal Resistance Θ<sub>JC</sub> = 1.7 °C/W (3 ms pulses, 10% duty cycle)

## Evaluation Board Outline

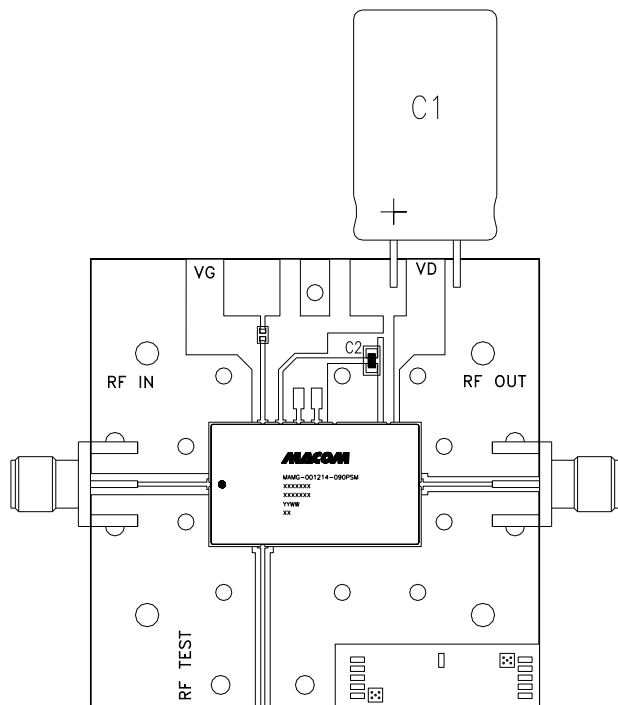

## Parts List

Part	Value	Case Style
C1	100 $\mu$ F	Radial
C2	10 nF	0603

Parts are measured and sampled in the evaluation board shown on the left. The board is made of 8-mil thick RO4003C and is bolted onto a Ni-plated Aluminum plate. Electrical and thermal ground is provided using a Cu-filled via-hole array (pictured below). Very few external components are used, as DC blocks are not required.

## Bias Sequencing

### Turning the device ON

1. Set  $V_G$  to the pinch-off value ( $V_P$ ), typically -6 V.
2. Turn on  $V_D$  to nominal voltage (50 V).
3. Increase  $V_G$  to desired quiescent current.
4. Apply RF power to desired level.

### Turning the device OFF

1. Turn off RF power.
2. Decrease  $V_G$  down to  $V_P$ .
3. Turn off  $V_D$ .
4. Turn off  $V_G$ .

## Applications Section

### Typical Large-Signal Performance Curves:

Freq. = 1.3 GHz, 1 ms Pulses, 10% Duty Cycle,  $V_{DD} = 45\text{ V}$ ,  $I_{DQ} = 300\text{ mA}$ ,  $T_A = 25^\circ\text{C}$

*Output Power vs. Input Power*

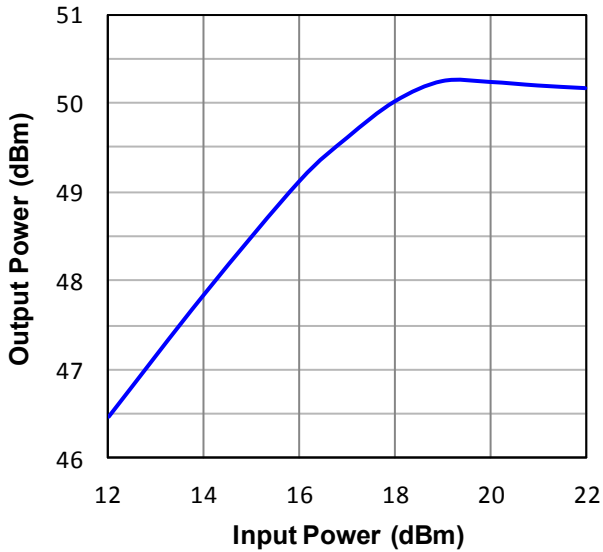

*Power Added Efficiency vs. Input Power*

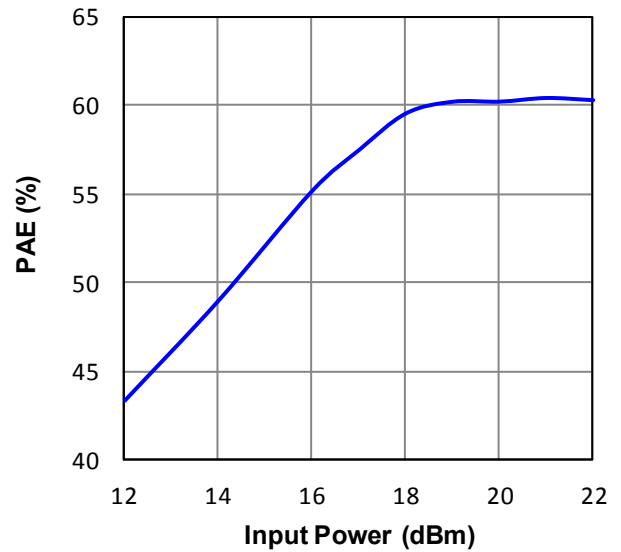

*2F0 and 3F0 Harmonics vs. Input Power*

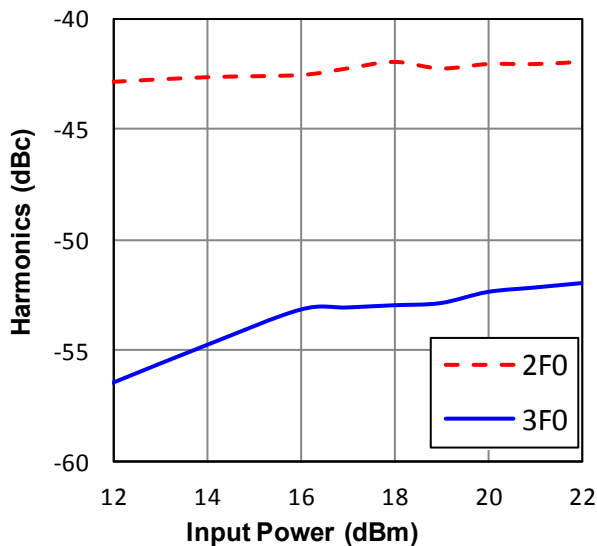

## Applications Section

**Typical Large-Signal Performance Curves Over Frequency:  
1 ms Pulses, 10% Duty Cycle,  $V_{DD} = 45\text{ V}$ ,  $I_{DQ} = 300\text{ mA}$ ,  $T_A = 25^\circ\text{C}$**

*Output Power vs. Frequency*

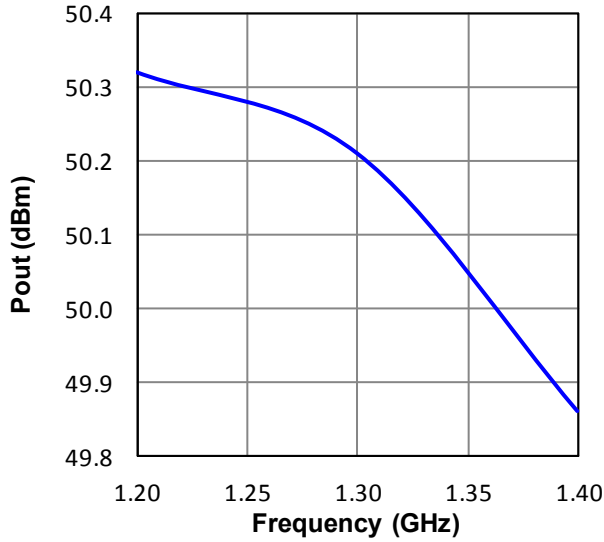

*Power Added Efficiency vs. Frequency*

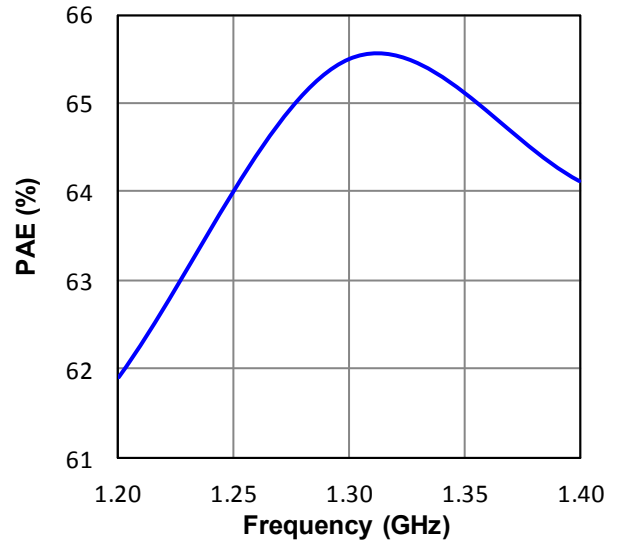

*Pulse Droop vs. Frequency*

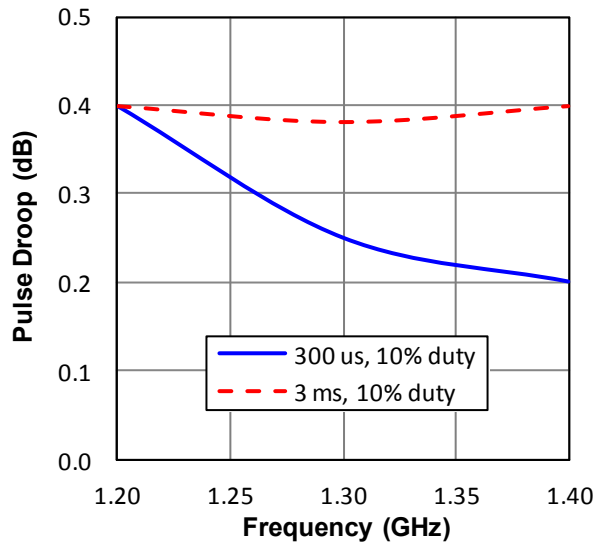

## Applications Section

**Typical Large-Signal Performance Curves Over Temperature:**  
**1 ms Pulses, 10% Duty Cycle,  $V_{DD} = 45\text{ V}$ ,  $I_{DQ} = 300\text{ mA}$**

**Output Power vs. Frequency**

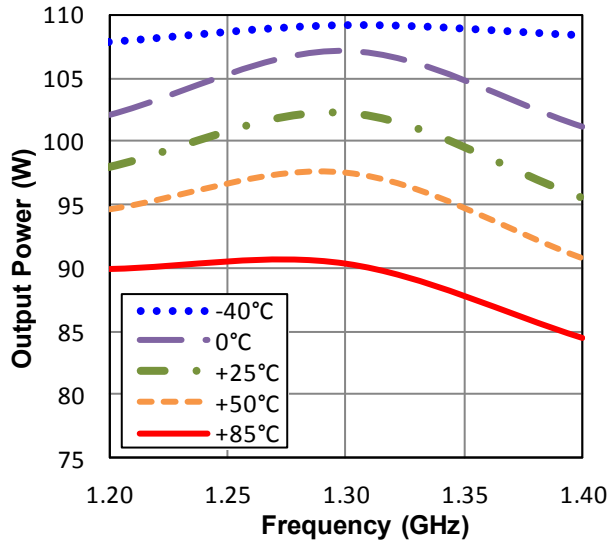

**PAE vs. Frequency**

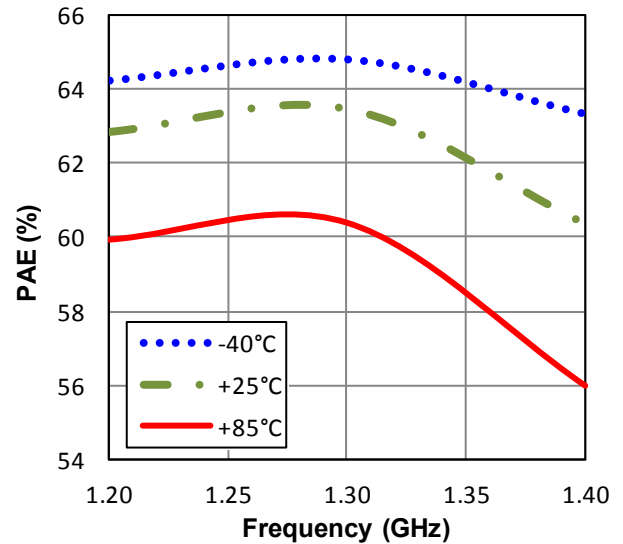

**Pulse Droop vs. Frequency**

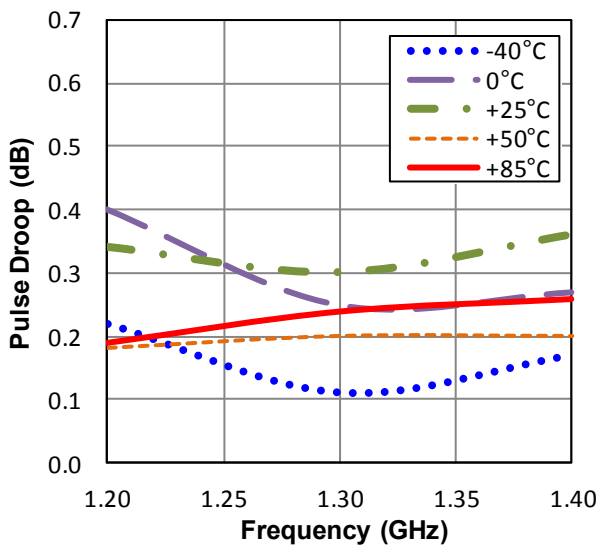

## L-Band 90 W 2-Stage Fully Matched GaN Module Surface Mount Laminate Package

Rev. V3

### Package Outline <sup>15,16,18</sup>

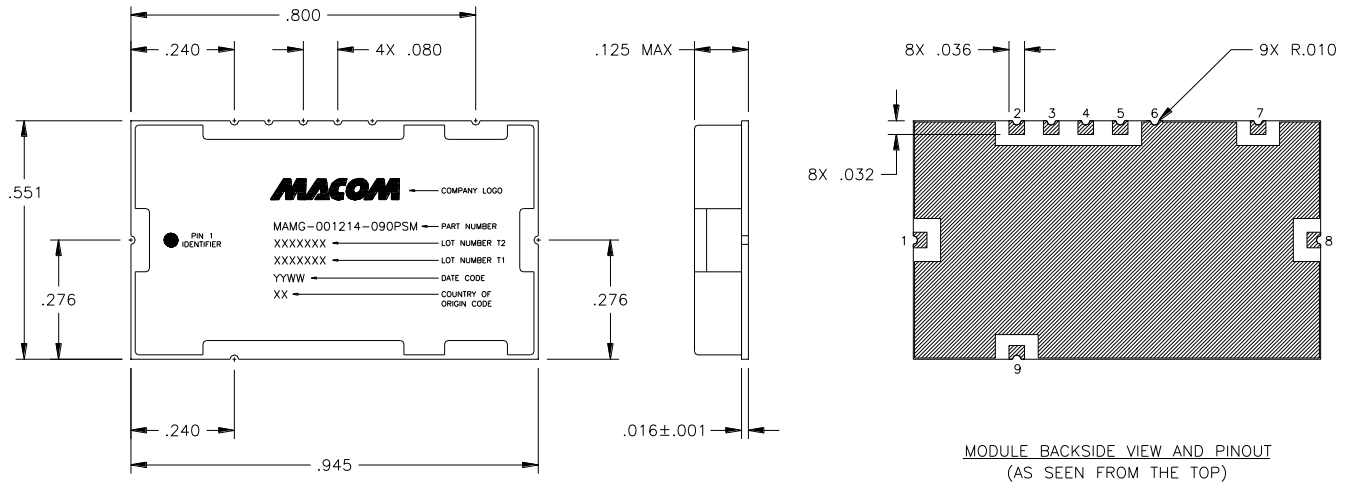

### Recommended Landing Pattern <sup>15,16,17,18</sup>

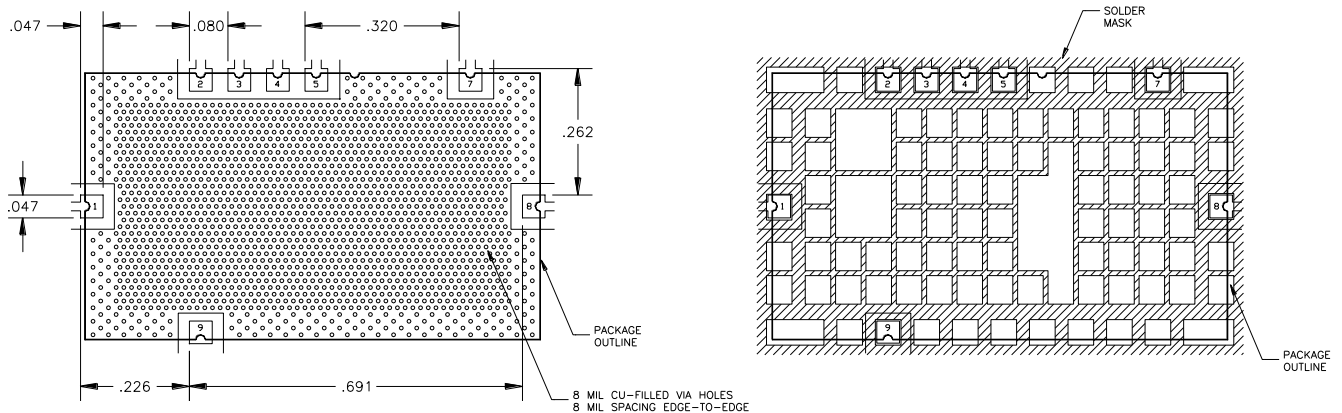

15. All dimensions are in inches.
16. Reference Application Note S2083 for lead-free solder reflow recommendations. Plating is Ni/Pd/Au.
17. Landing pattern indicates solder mask opening. Cu-filled via-holes under the ground are used for optimal thermal performance. Recommended pattern: 8-mil diameter, 8-mil spacing.
18. Layout drawing available upon request.

### Handling Procedures

Please observe the following precautions to avoid damage:

### Static Sensitivity

Gallium Nitride Devices and Circuits are sensitive to electrostatic discharge (ESD) and can be damaged by static electricity. Proper ESD control techniques should be used when handling these devices.