



Chipsmall Limited consists of a professional team with an average of over 10 year of expertise in the distribution of electronic components. Based in Hongkong, we have already established firm and mutual-benefit business relationships with customers from,Europe,America and south Asia,supplying obsolete and hard-to-find components to meet their specific needs.

With the principle of "Quality Parts,Customers Priority,Honest Operation,and Considerate Service",our business mainly focus on the distribution of electronic components. Line cards we deal with include Microchip,ALPS,ROHM,Xilinx,Pulse,ON,Everlight and Freescale. Main products comprise IC,Modules,Potentiometer,IC Socket,Relay,Connector.Our parts cover such applications as commercial,industrial, and automotives areas.

We are looking forward to setting up business relationship with you and hope to provide you with the best service and solution. Let us make a better world for our industry!



## Contact us

Tel: +86-755-8981 8866 Fax: +86-755-8427 6832

Email & Skype: info@chipsmall.com Web: www.chipsmall.com

Address: A1208, Overseas Decoration Building, #122 Zhenhua RD., Futian, Shenzhen, China



## SPDT High Isolation Terminated Switch 0.01 - 3.0 GHz

Rev. V4

### Features

- Positive Voltage Control: 0 / +5 V
- High Isolation: 55 dB @ 0.9 GHz  
50 dB @ 1.9 GHz
- 50  $\Omega$  Internal Terminations
- Low Insertion Loss: 0.6 dB @ 0.9 GHz  
0.7 dB @ 1.9 GHz
- Lead-Free MSOP-8-EP Package
- Halogen-Free "Green" Mold Compound
- 260°C Reflow Compatible
- RoHS\* Compliant Version of MASWSS0024

### Description

The MASWSS0178 GaAs monolithic switch provides high isolation in a lead-free, plastic surface mount package.

The MASWSS0178 is ideal for applications across a broad range of frequencies including synthesizer switching, transmit / receive switching, switch matrices and filter banks in systems such as radio and cellular equipment, PCS, GPS, and fiber optic modules.

M/A-COM Technology fabricates the MASWSS0178 using a 1.0-micron gate length MESFET process. The process features full chip passivation for performance and reliability.

### Ordering Information <sup>1</sup>

Part Number	Package
MASWSS0178	Bulk Packaging
MASWSS0178TR-3000	3000 piece reel
MASWSS0178SMB	Sample Board

1. Reference Application Note M513 for reel size information.

### Functional Schematic <sup>2</sup>

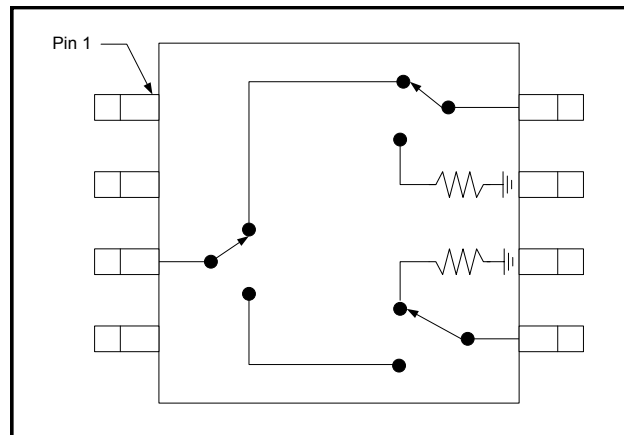

2. The exposed pad centered on the package bottom must be connected to RF and DC ground.

### Pin Configuration

Pin No.	Function	Pin No.	Function
1	Control 1	5	RF Port 2
2	Control 2	6	Ground
3	RF Common	7	Ground
4	Ground	8	RF Port 1

### Absolute Maximum Ratings <sup>3,4</sup>

Parameter	Absolute Maximum
Input Power (0.5 - 3.0 GHz) 3 V Control 5 V Control	+30 dBm +33 dBm
Operating Voltage	+8.5 Volts
Operating Temperature	-40°C to +85°C
Storage Temperature	-65°C to +150°C

3. Exceeding any one or combination of these limits may cause permanent damage to this device.
4. M/A-COM Technology does not recommend sustained operation near these survivability limits.

\* Restrictions on Hazardous Substances, European Union Directive 2002/95/EC.

## SPDT High Isolation Terminated Switch 0.01 - 3.0 GHz

Rev. V4

**Electrical Specifications:  $T_A = 25^\circ\text{C}$ ,  $V_C = 0\text{ V} / 5\text{ V}$ ,  $Z_0 = 50\ \Omega$  <sup>5</sup>**

Parameter	Test Conditions	Units	Min.	Typ.	Max.
Insertion Loss	0.01 - 0.5 GHz	dB	—	0.5	—
	0.5 - 1.0 GHz		—	0.6	0.7
	1.0 - 2.0 GHz		—	0.7	0.8
	2.0 - 3.0 GHz		—	0.75	—
Isolation	0.01 - 0.5 GHz	dB	—	59	—
	0.5 - 1.0 GHz		51	57	—
	1.0 - 2.0 GHz		44	53	—
	2.0 - 3.0 GHz		—	43	—
Return Loss	0.01 - 0.5 GHz <sup>6</sup>	dB	—	20	—
	0.5 - 1.0 GHz		—	20	—
	1.0 - 2.0 GHz		—	20	—
	2.0 - 3.0 GHz		—	20	—
Input IP <sub>2</sub>	2-Tone, 900 MHz, 5 MHz spacing	dBm	—	83	—
Input IP <sub>3</sub>	2-Tone, 900 MHz, 5 MHz spacing	dBm	—	43	—
Input P1dB Compression	$V_C = 0\text{ V}/5.0\text{ V}$ , 1 GHz	dBm	—	29	—
	$V_C = 0\text{ V}/3.0\text{ V}$ , 1 GHz		—	17.5	—
Trise, Tfall	10% to 90% RF & 90% to 10% RF	ns	—	24	—
Ton, Toff	50% of $V_C$ to 10% / 90% RF	ns	—	15	—
Transients	In-band	mV	—	12	—
Control Current	$V_C = 5\text{ V}$	$\mu\text{A}$	—	2	13

5. External DC blocking capacitors are required on all RF ports (47 pF capacitors are recommended). Use larger value capacitors for lower frequency operation (e.g. use 10,000 pF capacitors to optimize insertion and return loss at frequencies below 50 MHz).

6. Terminated return loss is governed by blocking capacitors internal to the device; see applications plot.

### Truth Table

V1	V2	RFC-RF1	RFC-RF2
0	1	Off	On
1	0	On	Off

Logic Level	Voltage Level
$V_{\text{LOW}}$ "0"	$0 \pm 0.2\text{ V}$
$V_{\text{HIGH}}$ "1"	3.0 V to 8.0 V

### Handling Procedures

Please observe the following precautions to avoid damage:

### Static Sensitivity

Gallium Arsenide Integrated Circuits are sensitive to electrostatic discharge (ESD) and can be damaged by static electricity. Proper ESD control techniques should be used when handling these devices.

## SPDT High Isolation Terminated Switch 0.01 - 3.0 GHz

Rev. V4

### Typical Performance Curves

Return Loss

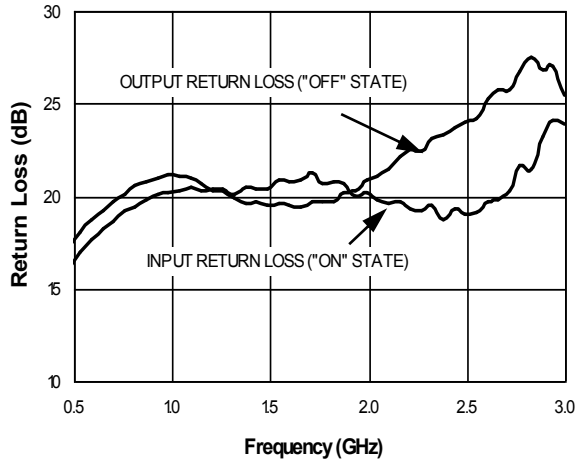

Insertion Loss

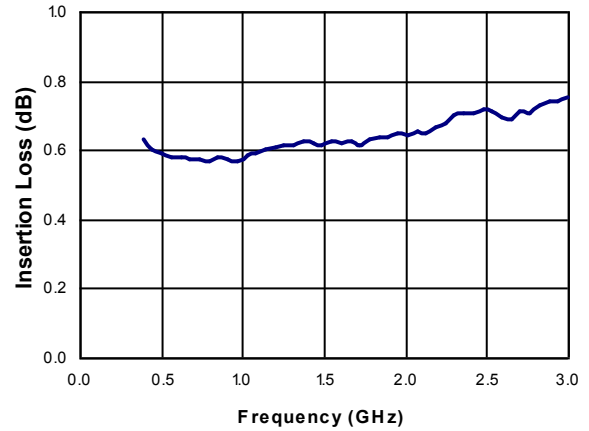

Isolation

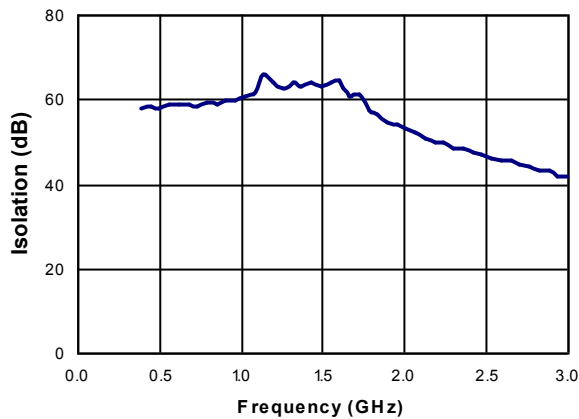

Lead-Free MSOP-8-EP†

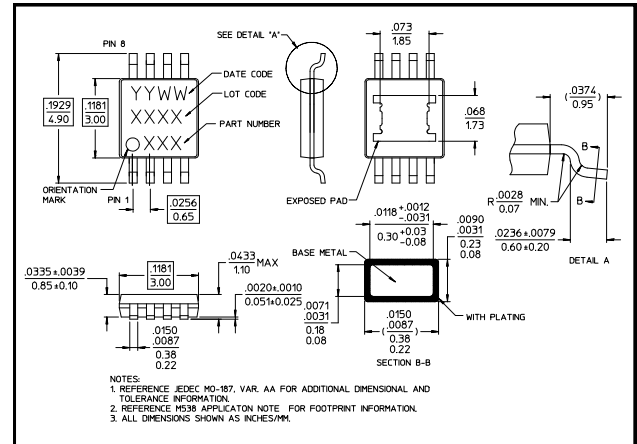

† Reference Application Note M538 for lead-free solder reflow recommendations

Meets JEDEC moisture sensitivity level 1 requirements.  
Plating is 100% matte tin over copper.

## Applications Section

### Typical Performance Curves, Very Low Frequency, 10000 pF Blocking Capacitors

*Return Loss vs. Frequency*

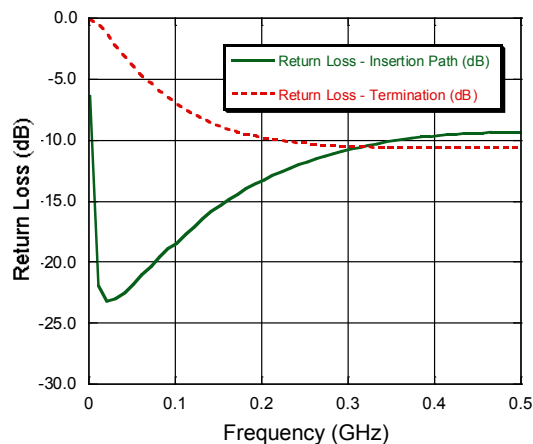

*Insertion Loss vs. Frequency*

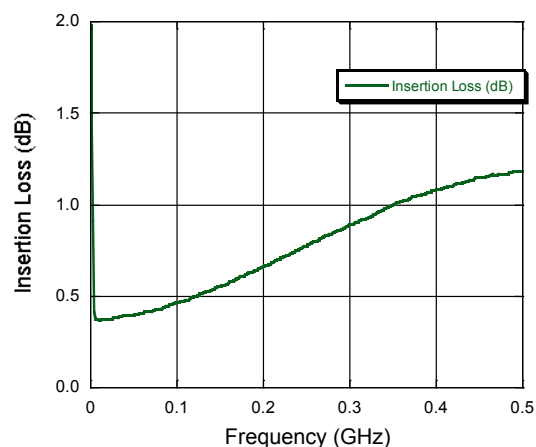

*Isolation vs. Frequency*

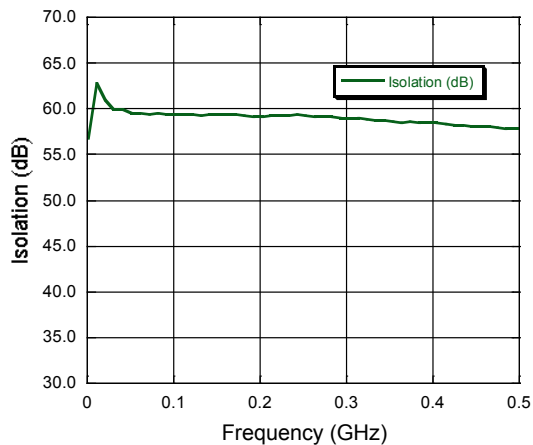

M/A-COM Technology Solutions Inc. All rights reserved.

Information in this document is provided in connection with M/A-COM Technology Solutions Inc ("MACOM") products. These materials are provided by MACOM as a service to its customers and may be used for informational purposes only. Except as provided in MACOM's Terms and Conditions of Sale for such products or in any separate agreement related to this document, MACOM assumes no liability whatsoever. MACOM assumes no responsibility for errors or omissions in these materials. MACOM may make changes to specifications and product descriptions at any time, without notice. MACOM makes no commitment to update the information and shall have no responsibility whatsoever for conflicts or incompatibilities arising from future changes to its specifications and product descriptions. No license, express or implied, by estoppel or otherwise, to any intellectual property rights is granted by this document.

THESE MATERIALS ARE PROVIDED "AS IS" WITHOUT WARRANTY OF ANY KIND, EITHER EXPRESS OR IMPLIED, RELATING TO SALE AND/OR USE OF MACOM PRODUCTS INCLUDING LIABILITY OR WARRANTIES RELATING TO FITNESS FOR A PARTICULAR PURPOSE, CONSEQUENTIAL OR INCIDENTAL DAMAGES, MERCHANTABILITY, OR INFRINGEMENT OF ANY PATENT, COPYRIGHT OR OTHER INTELLECTUAL PROPERTY RIGHT. MACOM FURTHER DOES NOT WARRANT THE ACCURACY OR COMPLETENESS OF THE INFORMATION, TEXT, GRAPHICS OR OTHER ITEMS CONTAINED WITHIN THESE MATERIALS. MACOM SHALL NOT BE LIABLE FOR ANY SPECIAL, INDIRECT, INCIDENTAL, OR CONSEQUENTIAL DAMAGES, INCLUDING WITHOUT LIMITATION, LOST REVENUES OR LOST PROFITS, WHICH MAY RESULT FROM THE USE OF THESE MATERIALS.

MACOM products are not intended for use in medical, lifesaving or life sustaining applications. MACOM customers using or selling MACOM products for use in such applications do so at their own risk and agree to fully indemnify MACOM for any damages resulting from such improper use or sale.