



Chipsmall Limited consists of a professional team with an average of over 10 year of expertise in the distribution of electronic components. Based in Hongkong, we have already established firm and mutual-benefit business relationships with customers from,Europe,America and south Asia,supplying obsolete and hard-to-find components to meet their specific needs.

With the principle of “Quality Parts,Customers Priority,Honest Operation,and Considerate Service”,our business mainly focus on the distribution of electronic components. Line cards we deal with include Microchip,ALPS,ROHM,Xilinx,Pulse,ON,Everlight and Freescale. Main products comprise IC,Modules,Potentiometer,IC Socket,Relay,Connector.Our parts cover such applications as commercial,industrial, and automotives areas.

We are looking forward to setting up business relationship with you and hope to provide you with the best service and solution. Let us make a better world for our industry!



## Contact us

Tel: +86-755-8981 8866 Fax: +86-755-8427 6832

Email & Skype: info@chipsmall.com Web: www.chipsmall.com

Address: A1208, Overseas Decoration Building, #122 Zhenhua RD., Futian, Shenzhen, China



# MAX11300

## PIXI, 20-Port Programmable Mixed-Signal I/O with 12-Bit ADC, 12-Bit DAC, Analog Switches, and GPIO

### General Description

The MAX11300 integrates a PIXI™, 12-bit, multichannel, analog-to-digital converter (ADC) and a 12-bit, multichannel, buffered digital-to-analog converter (DAC) in a single integrated circuit. This device offers 20 mixed-signal high-voltage, bipolar ports, which are configurable as an ADC analog input, a DAC analog output, a general-purpose input (GPI), a general-purpose output (GPO), or an analog switch terminal. One internal and two external temperature sensors track junction and environmental temperature. Adjacent pairs of ports are configurable as a logic-level translator for open-drain devices or an analog switch.

PIXI ports provide highly flexible hardware configuration for 12-bit mixed-signal applications. The MAX11300 is best suited for applications that demand a mixture of analog and digital functions. Each port is individually configurable with up to four selectable voltage ranges within -10V to +10V.

The MAX11300 allows for the averaging of 2, 4, 8, 16, 32, 64, or 128 ADC samples from each ADC-configured port to improve noise performance. A DAC-configured output port can drive up to 25mA. The GPIO ports can be programmed to user-defined logic levels, and a GPI coupled with a GPO forms a logic-level translator.

Internal and external temperature measurements monitor programmable conditions of minimum and maximum temperature limits, using the interrupt to notify the host if one or more conditions occur. The temperature measurement results are made available through the serial interface.

The device features an internal, low-noise 2.5V voltage reference and provides the option to use external voltage references with separate inputs for the DAC and ADC. The device uses a 4-wire, 20MHz, SPI-compatible serial interface, operating from a 5V analog supply and a 1.8V to 5.0V digital supply. The PIXI port supply voltages operate from a wide range of -12.0V to +12.0V.

The MAX11300 is available in a 40-pin TQFN, 6mm x 6mm package or a 48-pin TQFP, 7mm x 7mm package specified over the -40°C to +105°C temperature range.

### Applications

- Base Station RF Power Device Bias Controllers
- System Supervision and Control
- Power-Supply Monitoring
- Industrial Control and Automation
- Control for Optical Components

### Benefits and Features

- 20 Configurable Mixed-Signal Ports Maximize Design Flexibility Across Platforms
  - Up to 20 12-Bit ADC Inputs
    - Single-Ended, Differential, or Pseudo-Differential
    - Range Options: 0 to 2.5V, ±5V, 0 to +10V, -10V to 0V
    - Programmable Sample Averaging Per ADC Port
    - Unique Voltage Reference for Each ADC PIXI Port
  - Up to 20 12-Bit DAC Outputs
    - Range Options: ±5V, 0 to +10V, -10V to 0V
    - 25mA Current Drive Capability with Overcurrent Protection
  - Up to 20 General-Purpose Digital I/Os
    - 0 to +5V GPI Input Range
    - 0 to +2.5V GPI Programmable Threshold Range
    - 0 to +10V GPO Programmable Output Range
    - Logic-Level Shifting Between Any Two Pins
  - 60Ω Analog Switch Between Adjacent PIXI Ports
  - Internal/External Temperature Sensors, ±1°C Accuracy
- Adapts to Specific Application Requirements and Allows for Easy Reconfiguration as System Needs Change
- Configurability of Functions Enables Optimized PCB Layout
- Reduces BOM Cost with Fewer Components in Small Footprint
  - 36mm<sup>2</sup> 40-Pin TQFN
  - 49mm<sup>2</sup> 48-Pin TQFP

[Ordering Information](#) appears at end of data sheet.

*PIXI is a trademark of Maxim Integrated Products, Inc.*



Functional Diagram

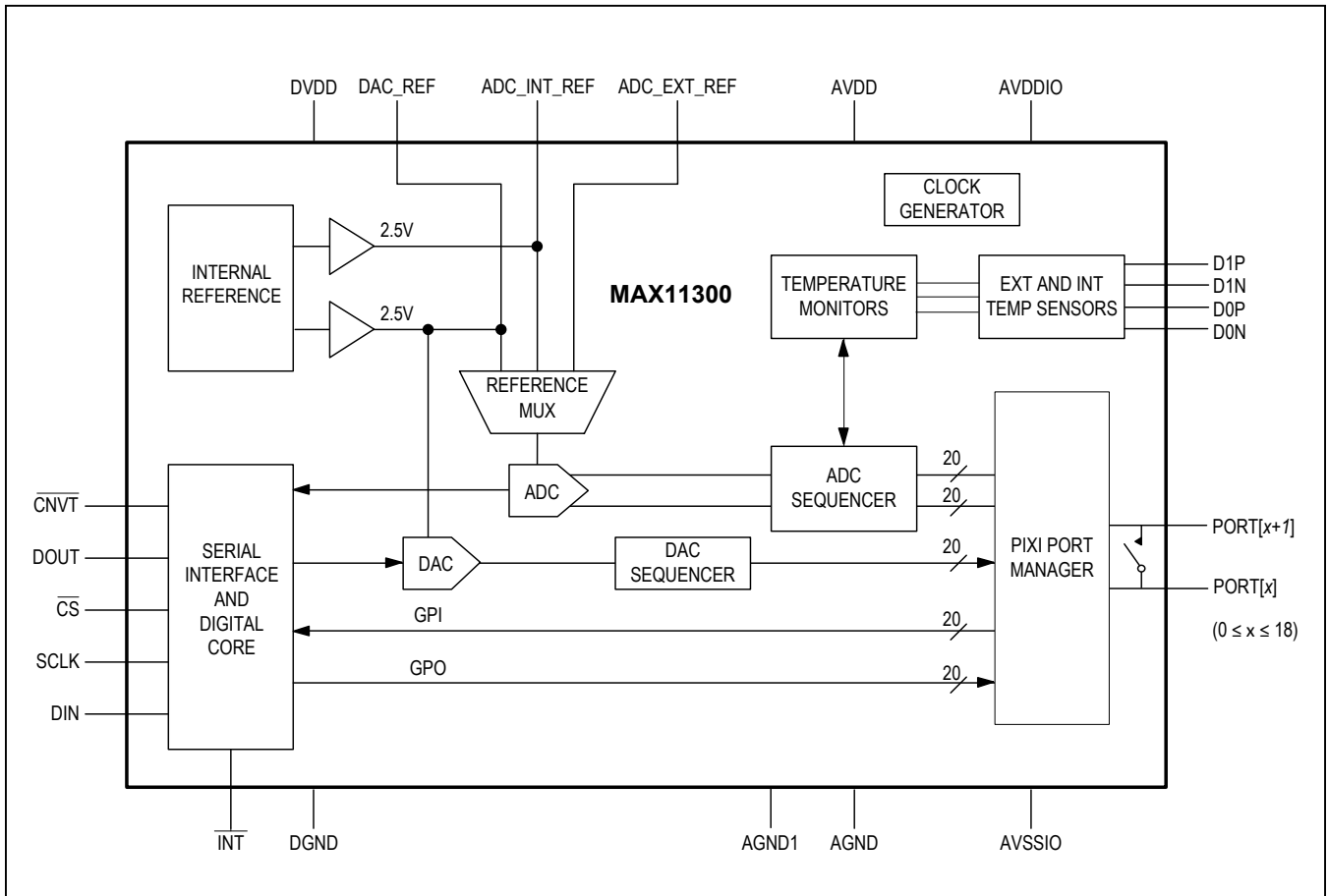

**Absolute Maximum Ratings**

DVDD to DGND.....	-0.3V to +6V	DAC and ADC Reference Pins to AGND (DAC_REF, ADC_INT_REF, ADC_EXT_REF).....	-0.3V to the min of (V <sub>AVDD</sub> + 0.3V) or +4V
AVDD to AGND .....	-0.3V to +6V	Temperature Sensor Pins (D0N, D0P, D1N, D1P) to AGND.....	-0.3V to the min of (V <sub>AVDD</sub> + 0.3V) or +6V
AVDDIO to AVSSIO.....	-0.3V to +25V	Current into Any PORT Pin .....	100mA
AVDDIO to AGND.....	-0.3V to +17V	Current into Any Other Pin Except Supplies and Ground.....	50mA
AVSSIO to AGND .....	-14V to +0.3V	Continuous Power Dissipation (T <sub>A</sub> = +70°C) (Multilayer board) TQFN (derate 37mW/°C above +70°C) .....	2963mW
AGND to AGND1.....	-0.3V to +0.3V	TQFP (derate 36.2mW/°C above +70°C).....	2898.6mW
AGND to DGND .....	-0.3V to +0.3V	Operating Temperature Range.....	-40°C to +105°C
AGND1 to DGND .....	-0.3V to +0.3V	Storage Temperature Range.....	-65°C to +150°C
(PORT0 to PORT19) to AGND.....	max of (V <sub>AVSSIO</sub> - 0.3V) or -14V to min of (V <sub>AVDDIO</sub> + 0.3V) or +17V	Lead Temperature (soldering, 10s) .....	+300°C
(PORT0 to PORT19) to AGND (GPI and Bidirectional Level Translator Modes).....	-0.3V to the min of (V <sub>AVDD</sub> + 0.3V) or +6V	Soldering Temperature (reflow).....	+260°C
( $\overline{\text{CNVT}}$ , DOUT) to DGND... ..	-0.3V to the min of (V <sub>DVDD</sub> + 0.3V) or +6V		
( $\overline{\text{CS}}$ , SCLK, DIN, $\overline{\text{INT}}$ ) to DGND.....	-0.3V to +6V		

Stresses beyond those listed under "Absolute Maximum Ratings" may cause permanent damage to the device. These are stress ratings only, and functional operation of the device at these or any other conditions beyond those indicated in the operational sections of the specifications is not implied. Exposure to absolute maximum rating conditions for extended periods may affect device reliability.

**Package Thermal Characteristics (Note 1)**

TQFN	Junction-to-Case Thermal Resistance ( $\theta_{\text{JC}}$ ).....	1°C/W	TQFP	Junction-to-Case Thermal Resistance ( $\theta_{\text{JC}}$ ).....	2°C/W
	Junction-to-Ambient Thermal Resistance ( $\theta_{\text{JA}}$ ).....	27°C/W		Junction-to-Ambient Thermal Resistance ( $\theta_{\text{JA}}$ ).....	27.6°C/W

**Note 1:** Package thermal resistances were obtained using the method described in JEDEC specification JESD51-7, using a four-layer board. For detailed information on package thermal considerations, refer to [www.maximintegrated.com/thermal-tutorial](http://www.maximintegrated.com/thermal-tutorial).

**Electrical Characteristics**

**ADC Electrical Specifications**

(V<sub>AVDD</sub> = 4.75V to 5.25V, V<sub>DVDD</sub> = 3.3V, V<sub>AVDDIO</sub> = +12.0V, V<sub>AGND</sub> = V<sub>DGND</sub> = 0V, V<sub>AVSSIO</sub> = -2.0V, V<sub>DACREF</sub> = 2.5V, V<sub>ADCREF</sub> = 2.5V (Internal), f<sub>S</sub> = 400ksps, 10V analog input range set to range 1 (0 to +10V). T<sub>A</sub> = -40°C to +105°C, unless otherwise noted. Typical values are at T<sub>A</sub> = +25°C.) (Note 2)

PARAMETER	SYMBOL	CONDITIONS	MIN	TYP	MAX	UNITS
<b>DC ACCURACY (Note 3)</b>						
Resolution			12			Bits
Integral Nonlinearity	INL				±2.5	LSB
Differential Nonlinearity	DNL	No missing codes over temperature			±1	LSB
Offset Error				±0.5	±8	LSB
Offset Error Drift				±0.002		LSB/°C
Gain Error					±11	LSB
Gain Error Drift				±0.01		LSB/°C
Channel-to-Channel Offset Matching				1		LSB
Channel-to-Channel Gain Matching				2		LSB

**Electrical Characteristics (continued)**

**ADC Electrical Specifications**

(V<sub>AVDD</sub> = 4.75V to 5.25V, V<sub>DVDD</sub> = 3.3V, V<sub>AVDDIO</sub> = +12.0V, V<sub>AGND</sub> = V<sub>DGND</sub> = 0V, V<sub>AVSSIO</sub> = -2.0V, V<sub>DACREF</sub> = 2.5V, V<sub>ADCREf</sub> = 2.5V (Internal), f<sub>S</sub> = 400ksps, 10V analog input range set to range 1 (0 to +10V). T<sub>A</sub> = -40°C to +105°C, unless otherwise noted. Typical values are at T<sub>A</sub> = +25°C.) (Note 2)

PARAMETER	SYMBOL	CONDITIONS	MIN	TYP	MAX	UNITS
<b>DYNAMIC PERFORMANCE (Single-Ended Inputs)</b>						
Signal-to-Noise Plus Distortion	SINAD	f <sub>S</sub> = 400ksps, f <sub>IN</sub> = 10kHz		70		dB
Signal to Noise	SNR	f <sub>S</sub> = 400ksps, f <sub>IN</sub> = 10kHz		71		dB
Total Harmonic Distortion	THD	f <sub>S</sub> = 400ksps, f <sub>IN</sub> = 10kHz		-75		dB
Spurious-Free Dynamic Range	SFDR	f <sub>S</sub> = 400ksps, f <sub>IN</sub> = 10kHz		75		dB
Crosstalk		f <sub>S</sub> = 100ksps, f <sub>IN</sub> = 10kHz		-85		dB
<b>DYNAMIC PERFORMANCE (Differential Inputs)</b>						
Signal-to-Noise Plus Distortion	SINAD	f <sub>S</sub> = 400ksps, f <sub>IN</sub> = 10kHz		71		dB
Signal to Noise	SNR	f <sub>S</sub> = 400ksps, f <sub>IN</sub> = 10kHz		72		dB
Total Harmonic Distortion	THD	f <sub>S</sub> = 400ksps, f <sub>IN</sub> = 10kHz		-82		dB
Spurious-Free Dynamic Range	SFDR	f <sub>S</sub> = 400ksps, f <sub>IN</sub> = 10kHz		82		dB
Crosstalk		f <sub>S</sub> = 100ksps, f <sub>IN</sub> = 10kHz		-85		dB
<b>CONVERSION RATE</b>						
Throughput (Note 4)		ADCCONV[1:0] = 00		200		ksps
		ADCCONV[1:0] = 01		250		
		ADCCONV[1:0] = 10		333		
		ADCCONV[1:0] = 11		400		
Acquisition Time	t <sub>ACQ</sub>	ADCCONV[1:0] = 00		3.5		μs
		ADCCONV[1:0] = 01		2.5		
		ADCCONV[1:0] = 10		1.5		
		ADCCONV[1:0] = 11		1.0		
<b>ANALOG INPUT (All Ports)</b>						
Absolute Input Voltage (Note 5)	V <sub>PORT</sub>	Range 1	0		10	V
		Range 2	-5		+5	
		Range 3	-10		0	
		Range 4	0		2.5	
Input Resistance		Range 1, 2, 3	70	100	130	kΩ
		Range 4	50	75	100	kΩ

**REF Electrical Specifications**

( $V_{AVDD} = 4.75V$  to  $5.25V$ ,  $V_{DVDD} = 3.3V$ ,  $V_{AVDDIO} = +12.0V$ ,  $V_{AGND} = V_{DGND} = 0V$ ,  $V_{AVSSIO} = -2.0V$ ,  $V_{DACREF} = 2.5V$ ,  $V_{ADCREf} = 2.5V$  (Internal),  $f_S = 400ksps$ , 10V analog input range set to range 1 (0 to +10V).  $T_A = -40^{\circ}C$  to  $+105^{\circ}C$ , unless otherwise noted. Typical values are at  $T_A = +25^{\circ}C$ .) (Note 2)

PARAMETER	SYMBOL	CONDITIONS	MIN	TYP	MAX	UNITS
<b>ADC INTERNAL REFERENCE</b>						
Reference Output Voltage		Internal references at $T_A = +25^{\circ}C$	2.494	2.5	2.506	V
REF Output Tempco (Note 6)	$T_{C-VREF}$			$\pm 10$	$\pm 25$	ppm/ $^{\circ}C$
Capacitor Bypass at ADC_INT_REF			4.7		10	$\mu F$
<b>DAC INTERNAL REFERENCE</b>						
Reference Output Voltage		Internal references at $T_A = +25^{\circ}C$	2.494	2.5	2.506	V
REF Output Tempco (Note 6)	$T_{C-VREF}$			$\pm 10$	$\pm 25$	ppm/ $^{\circ}C$
Capacitor Bypass at DAC_REF			4.7		10	$\mu F$
<b>ADC EXTERNAL REFERENCE</b>						
Reference Input Range			2		2.75	V
<b>DAC EXTERNAL REFERENCE</b>						
Reference Input Range			1.25		2.5	V

**GPIO Electrical Specifications**

( $V_{AVDD} = 5.0V$ ,  $V_{DVDD} = 3.3V$ ,  $V_{AVDDIO} = +12.0V$ ,  $V_{AGND} = V_{DGND} = 0V$ ,  $V_{AVSSIO} = -2.0V$ ,  $V_{DACREF} = 2.5V$ ,  $V_{ADCREf} = 2.5V$  (Internal),  $f_S = 400ksps$ , 10V analog input range set to range 1 (0 to +10V).  $T_A = -40^{\circ}C$  to  $+105^{\circ}C$ , unless otherwise noted. Typical values are at  $T_A = +25^{\circ}C$ .) (Note 2)

PARAMETER	SYMBOL	CONDITIONS	MIN	TYP	MAX	UNITS
<b>GPIO EXCEPT IN BIDIRECTIONAL LEVEL TRANSLATION MODE</b>						
Programmable Input Logic Threshold	$V_{ITH}$		0.3		$V_{DACREF}$	V
Input High Voltage	$V_{IH}$		$V_{ITH} + 0.3$			V
Input Low Voltage	$V_{IL}$				$V_{ITH} - 0.3$	V
Hysteresis				$\pm 30$		mV
Programmable Output Logic Level	$V_{OLVL}$		0		$4 \times V_{DACREF}$	V
Propagation Delay from GPI Input to GPO Output in Unidirectional Level Translating Mode		Midscale threshold, 5V logic swing		2		$\mu s$
<b>BIDIRECTIONAL LEVEL TRANSLATION PATH AND ANALOG SWITCH</b>						
Input High Voltage	$V_{IH}$		1			V
Input Low Voltage	$V_{IL}$				0.2	V
On-Resistance		From $V_{AVSSIO} + 2.50V$ to $V_{AVDDIO} - 2.50V$			60	$\Omega$

**GPIO Electrical Specifications (continued)**

( $V_{AVDD} = 4.75V$  to  $5.25V$ ,  $V_{DVDD} = 3.3V$ ,  $V_{AVDDIO} = +12.0V$ ,  $V_{AGND} = V_{DGND} = 0V$ ,  $V_{AVSSIO} = -2.0V$ ,  $V_{DACREF} = 2.5V$ ,  $V_{ADCREf} = 2.5V$  (Internal),  $f_S = 400ksps$ , 10V analog input range set to range 1 (0 to +10V).  $T_A = -40^{\circ}C$  to  $+105^{\circ}C$ , unless otherwise noted. Typical values are at  $T_A = +25^{\circ}C$ .) (Note 2)

PARAMETER	SYMBOL	CONDITIONS	MIN	TYP	MAX	UNITS
Propagation Delay		10k $\Omega$ pullup resistors to rail in each side. Midvoltage to midvoltage when driving side goes from high to low			1	$\mu s$
<b>ANALOG SWITCH</b>						
Turn-On Delay		(Note 7)			400	ns
Turn-Off Delay		(Note 7)			400	ns
On-Time Duration		(Note 7)	1			$\mu s$
Off-Time Duration		(Note 7)	1			$\mu s$
On-Resistance		From $V_{AVSSIO} + 2.50V$ to $V_{AVDDIO} - 2.50V$			60	$\Omega$

**DAC Electrical Specifications**

( $V_{AVDD} = 4.75V$  to  $5.25V$ ,  $V_{DVDD} = 3.3V$ ,  $V_{AVDDIO} = +12.0V$ ,  $V_{AGND} = V_{DGND} = 0V$ ,  $V_{AVSSIO} = -2.0V$ ,  $V_{DACREF} = 2.5V$ ,  $V_{ADCREf} = 2.5V$  (Internal),  $f_S = 400ksps$ , 10V analog input range set to range 1 (0 to +10V).  $T_A = -40^{\circ}C$  to  $+105^{\circ}C$ , unless otherwise noted. Typical values are at  $T_A = +25^{\circ}C$ .) (Note 2)

PARAMETER	SYMBOL	CONDITIONS	MIN	TYP	MAX	UNITS
<b>DC ACCURACY</b>						
Resolution	N		12			Bits
Output Range (Note 5)	$V_{PORT}$	Range 1	0		+10	V
		Range 2	-5		+5	
		Range 3	-10		0	
Integral Linearity Error	INL	From code 100 to code 3996		$\pm 0.5$	$\pm 1.5$	LSB
Differential Linearity Error	DNL			$\pm 0.5$	$\pm 1$	LSB
Offset Voltage		At code 100			$\pm 20$	LSB
Offset Voltage Tempco				15		ppm/ $^{\circ}C$
Gain Error		From code 100 to code 3996	-0.6		+0.6	% of FS
Gain Error Tempco		From code 100 to code 3996		4		ppm of FS/ $^{\circ}C$
Power-Supply Rejection Ratio	PSRR			0.4		mV/V
<b>DYNAMIC CHARACTERISTICS</b>						
Output Voltage Slew Rate	SR			1.6		V/ $\mu s$
Output Settling Time		To $\pm 1$ LSB, from 0 to full scale, output load capacitance of 250pF (Note 7)		40		$\mu s$
Settling Time After Current-Limit Condition				6		$\mu s$
Noise		$f = 0.1Hz$ to 300kHz		3.8		mV <sub>P-P</sub>

**DAC Electrical Specifications (continued)**

( $V_{AVDD} = 4.75V$  to  $5.25V$ ,  $V_{DVDD} = 3.3V$ ,  $V_{AVDDIO} = +12.0V$ ,  $V_{AGND} = V_{DGND} = 0V$ ,  $V_{AVSSIO} = -2.0V$ ,  $V_{DACREF} = 2.5V$ ,  $V_{ADCREf} = 2.5V$  (Internal),  $f_S = 400ksps$ , 10V analog input range set to range 1 (0 to +10V).  $T_A = -40^\circ C$  to  $+105^\circ C$ , unless otherwise noted. Typical values are at  $T_A = +25^\circ C$ .) (Note 2)

PARAMETER	SYMBOL	CONDITIONS	MIN	TYP	MAX	UNITS
<b>TRACK-AND-HOLD</b>						
Digital Feedthrough				5		nV·s
Hold Step				1	6	mV
Droop Rate (note 6)				0.3	15	mV/s

**Interface Digital IO Electrical Specifications**

( $V_{AVDD} = 5.0V$ ,  $V_{DVDD} = 1.62V$  to  $5.50V$ ,  $V_{AVDDIO} = +12.0V$ ,  $V_{AGND} = V_{DGND} = 0V$ ,  $V_{AVSSIO} = -2.0V$ ,  $V_{DACREF} = 2.5V$ ,  $V_{ADCREf} = 2.5V$  (Internal),  $f_S = 400ksps$ , 10V analog input range set to range 1 (0 to +10V).  $T_A = -40^\circ C$  to  $+105^\circ C$ , unless otherwise noted. Typical values are at  $T_A = +25^\circ C$ .) (Note 2)

PARAMETER	SYMBOL	CONDITIONS	MIN	TYP	MAX	UNITS
<b>SPI IO DC SPECIFICATION</b>						
Input High Voltage (DIN, SCLK, CS, CNVT)		$V_{DVDD} = 2.50V$ to $5.50V$	$0.7 \times$ $V_{DVDD}$			V
		$V_{DVDD} = 1.62V$ to $2.50V$	$0.85 \times$ $V_{DVDD}$			V
Input Low Voltage (DIN, SCLK, CS, CNVT)		$V_{DVDD} = 2.50V$ to $5.50V$			$0.3 \times$ $V_{DVDD}$	V
		$V_{DVDD} = 1.62V$ to $2.50V$			$0.15 \times$ $V_{DVDD}$	V
Input Leakage Current (DIN, SCLK, CS, CNVT, INT)		Input voltage at DVDD	-10		+10	$\mu A$
Input Capacitance (DIN, SCLK, CS, CNVT)				10		pF
Output High Voltage (DOUT)		$I_{SRC} = 5mA$ , $V_{DVDD} = 2.50V$ to $5.50V$	$V_{DVDD} -$ 0.5			V
		$I_{SRC} = 2mA$ , $V_{DVDD} = 1.62V$ to $2.50V$	$V_{DVDD} -$ 0.3			V
Output Low Voltage (DOUT, INT)		$I_{SNK} = 5mA$ , $V_{DVDD} = 2.50V$ to $5.50V$			0.4	V
		$I_{SNK} = 2mA$ , $V_{DVDD} = 1.62V$ to $2.50V$			0.2	V
Output Leakage Current (DOUT)			-10		+10	$\mu A$



**Interface Digital IO Electrical Specifications (continued)**

( $V_{AVDD} = 5.0V$ ,  $V_{DVDD} = 1.62V$  to  $5.50V$ ,  $V_{AVDDIO} = +12.0V$ ,  $V_{AGND} = V_{DGND} = 0V$ ,  $V_{AVSSIO} = -2.0V$ ,  $V_{DACREF} = 2.5V$ ,  $V_{ADCREf} = 2.5V$  (Internal),  $f_S = 400kps$ , 10V analog input range set to range 1 (0 to +10V).  $T_A = -40^\circ C$  to  $+105^\circ C$ , unless otherwise noted. Typical values are at  $T_A = +25^\circ C$ .) (Note 2)

PARAMETER	SYMBOL	CONDITIONS	MIN	TYP	MAX	UNITS
<b>SPI TIMING REQUIREMENTS (See Figures 1 and 2)</b>						
SCLK Frequency	$f_{SCLK}$	$V_{DVDD} = 2.50V$ to $5.50V$			20	MHz
		$V_{DVDD} = 1.62V$ to $2.50V$			10	MHz
SCLK Clock Period	$t_{CP}$	$V_{DVDD} = 2.50V$ to $5.50V$	50			ns
		$V_{DVDD} = 1.62V$ to $2.50V$	100			ns
SCLK Pulse-Width High	$t_{CH}$		10			ns
SCLK Pulse-Width Low	$t_{CL}$	$V_{DVDD} = 2.50V$ to $5.50V$	25			ns
		$V_{DVDD} = 1.62V$ to $2.50V$	65			ns
$\overline{CS}$ Low to First SCLK Rise Setup	$t_{CSS0}$		5			ns
24th SCLK Rising Edge to $\overline{CS}$ Rising Edge	$t_{CSS1}$		5			ns
SCLK Rise to $\overline{CS}$ Low	$t_{CSH0}$		5			ns
$\overline{CS}$ Pulse-Width High	$t_{CSW}$		50			ns
DIN to SCLK Setup	$t_{DS}$		5			ns
DIN Hold After SCLK	$t_{DH}$		5			ns
DOUT Transition Valid After SCLK Fall	$t_{DOT}$	$V_{DVDD} = 2.50V$ to $5.50V$			23	ns
		$V_{DVDD} = 1.62V$ to $2.50V$			55	ns
$\overline{CS}$ Rise to DOUT Disable	$t_{DOD}$	$C_{LOAD} = 20pF$			50	ns

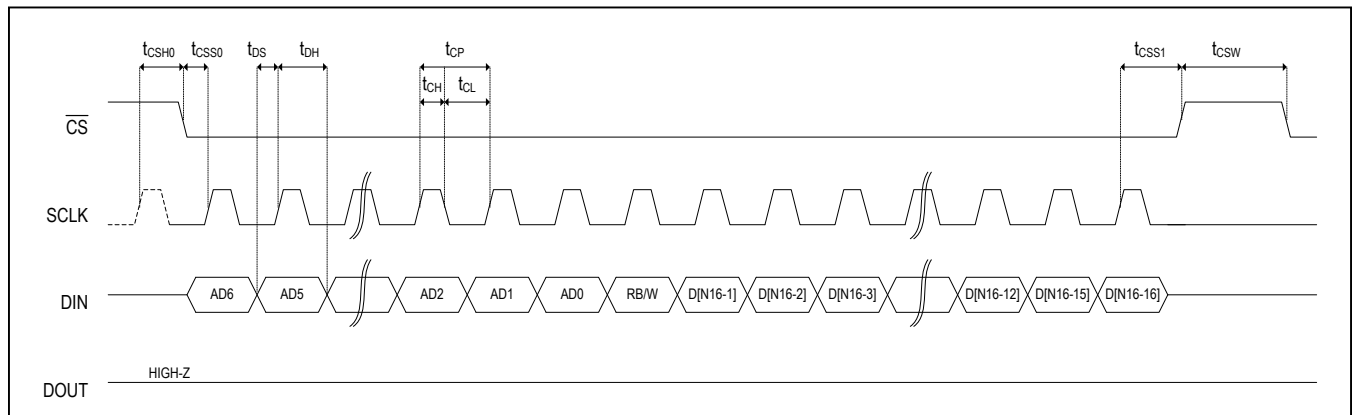

Figure 1. SPI Write Timing ( $N =$  Number of Words Written;  $N > 1$  for Burst Mode)

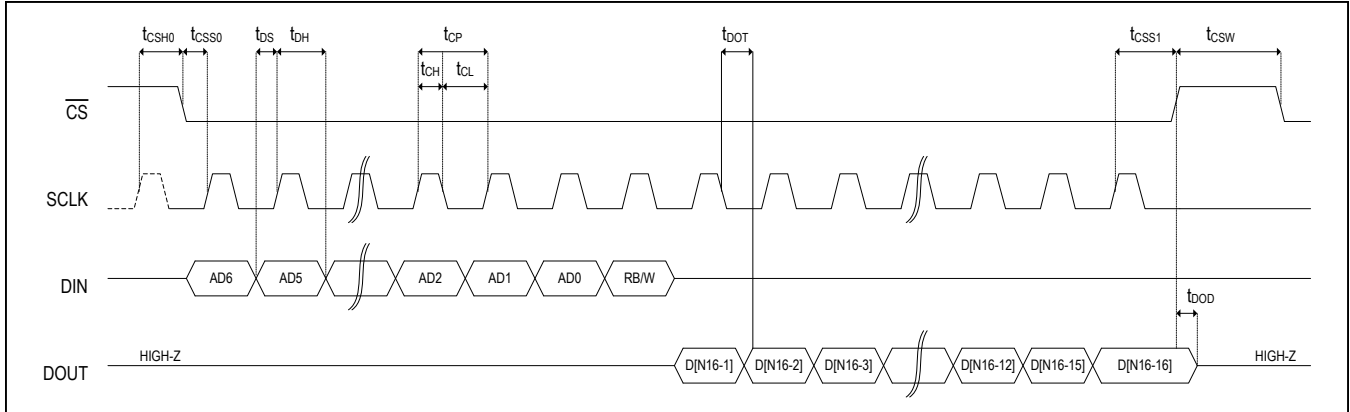

Figure 2. SPI Read Timing (N = Number of Words Written; N > 1 for Burst Mode)

**Internal and External Temperature Sensor Specifications**

(V<sub>AVDD</sub> = 4.75V to 5.25V, V<sub>DVDD</sub> = 3.3V, V<sub>AVDDIO</sub> = +12.0V, V<sub>AGND</sub> = V<sub>DGND</sub> = 0V, V<sub>AVSSIO</sub> = -2.0V, V<sub>DACREF</sub> = 2.5V, V<sub>ADCREf</sub> = 2.5V (Internal), f<sub>S</sub> = 400ksps, 10V analog input range set to range 1 (0 to +10V). T<sub>A</sub> = -40°C to +105°C, unless otherwise noted. Typical values are at T<sub>A</sub> = +25°C.) (Note 2)

PARAMETER	SYMBOL	CONDITIONS	MIN	TYP	MAX	UNITS
<b>ACCURACY</b>						
Accuracy of Internal Sensor (Note 6,8)		0°C ≤ T <sub>J</sub> ≤ +80°C		±0.3	±2.0	°C
		-40°C ≤ T <sub>J</sub> ≤ +125°C		±0.7	±5	°C
Accuracy of External Sensor (Note 6,8)		0°C ≤ T <sub>RJ</sub> ≤ +80°C		±0.3	±2.0	°C
		-40°C ≤ T <sub>RJ</sub> ≤ +150°C		±1.0	±5	°C
Temperature Measurement Resolution				0.125		°C
External Sensor Junction Current	High			68		µA
	Low			4		µA
External Sensor Junction Current	High	Series resistance cancellation mode		136		µA
	Low	Series resistance cancellation mode		8		µA
D0N/D1N Voltage		Internally generated		0.5		V

**Power Supply Specifications**

PARAMETER	SYMBOL	CONDITIONS	MIN	TYP	MAX	UNITS
$V_{AVDD}$			4.75		5.25	V
$V_{DVDD}$			1.62		5.50	V
$V_{AVDDIO}$			$V_{AVDD}$		15.75	V
$V_{AVSSIO}$			-12.0		0	V
$V_{AVDDIO}$ to $V_{AVSSIO}$			$V_{AVDD}$		24	V
$I_{AVDD}$		All ports in high-impedance mode		14	18	mA
		LPEN = 1		11		mA
		All ports in ADC-related modes		17		mA
		All ports in DAC-related modes		18		mA
$I_{DVDD}$		Serial interface in idle mode			2	$\mu$ A
$I_{AVDDIO}$		All ports in mode 0			150	$\mu$ A
$I_{AVSSIO}$		All ports in mode 0	-400			$\mu$ A

**Recommended VDDIO/VSSIO Supply Selection**

		ADC RANGE			
		-10V TO 0V	-5V TO +5V	0V TO +10V	0 TO 2.5V
DAC RANGE	-10V TO 0V	$V_{AVDDIO} = +5V$ $V_{AVSSIO} = -12V$	$V_{AVDDIO} = +5V$ $V_{AVSSIO} = -12V$	$V_{AVDDIO} = +10V$ $V_{AVSSIO} = -12V$	$V_{AVDDIO} = +5V$ $V_{AVSSIO} = -12V$
	-5V TO +5V	$V_{AVDDIO} = +7V$ $V_{AVSSIO} = -10V$	$V_{AVDDIO} = +7V$ $V_{AVSSIO} = -7V$	$V_{AVDDIO} = +10V$ $V_{AVSSIO} = -7V$	$V_{AVDDIO} = +7V$ $V_{AVSSIO} = -7V$
	0V TO +10V	$V_{AVDDIO} = +12V$ $V_{AVSSIO} = -10V$	$V_{AVDDIO} = +12V$ $V_{AVSSIO} = -5V$	$V_{AVDDIO} = +12V$ $V_{AVSSIO} = -2V$	$V_{AVDDIO} = +12V$ $V_{AVSSIO} = -2V$

The values of  $V_{AVDDIO}$  and  $V_{AVSSIO}$  supply voltages depend on the application circuit and the device configuration.

$V_{AVDDIO}$  needs to be the maximum of those four values:

- If one or more ports are in mode 3, 4, 5, 6, or 10 (DAC-related modes),  $V_{AVDDIO}$  must be set, at minimum, to the value of the largest voltage driven by any of the ports set in those modes. For improved linearity, it is recommended to set  $V_{AVDDIO}$  2.0V above the largest voltage value.
- If one or more ports are in mode 7, 8, or 9 (ADC-related modes),  $V_{AVDDIO}$  must be set, at minimum, to the value of the largest voltage applied to any of the ports set in those modes.
- If one or more ports are in mode 11 or 12 (Analog switch-related modes),  $V_{AVDDIO}$  must be set, at minimum, to 2.0V above the value of the largest voltage applied to any of the ports functioning as analog switch terminals.
- $V_{AVDDIO}$  cannot be set lower than  $V_{AVDD}$ .

$V_{AVSSIO}$  needs to be the minimum of those four values:

- If one or more ports are in mode 3, 4, 5, 6, or 10 (DAC-related modes),  $V_{AVSSIO}$  must be set, at maximum, to the value of the lowest voltage driven by any of the ports set in those modes. For improved linearity, it is recommended to set  $V_{AVSSIO}$  2.0V below the lowest voltage value.
- If one or more ports are in mode 7, 8, or 9 (ADC-related modes),  $V_{AVSSIO}$  must be set, at maximum, to the value of the lowest voltage applied to any of the ports set in those modes.

**Recommended VDDIO/VSSIO Supply Selection (continued)**

- If one or more ports are in mode 11 or 12 (Analog Switch-related modes),  $V_{AVSSIO}$  must be set, at maximum, to 2.0V below the value of the lowest voltage applied to any of the ports functioning as analog switch terminals.
- $V_{AVSSIO}$  cannot be set higher than  $V_{AGND}$ .

For example, the MAX11300 can operate with only one voltage supply of 5V ( $\pm 5\%$ ) connected to AVDD, AVDDIO, and DVDD, and one ground of 0V connected to AGND, DGND, and AVSSIO. However, the level of performance presented in the electrical specifications requires the setting of the supplies connected to AVDDIO and AVSSIO as previously described.

**Common PIXI Electrical Specifications**

( $V_{AVDD} = 4.75V$  to  $5.25V$ ,  $V_{DVDD} = 3.3V$ ,  $V_{AVDDIO} = +12.0V$ ,  $V_{AGND} = V_{DGND} = 0V$ ,  $V_{AVSSIO} = -2.0V$ ,  $V_{DACREF} = 2.5V$ ,  $V_{ADCREF} = 2.5V$  (Internal),  $f_S = 400ksps$ , 10V analog input range set to range 1 (0 to +10V).  $T_A = -40^\circ C$  to  $+105^\circ C$ , unless otherwise noted. Typical values are at  $T_A = +25^\circ C$ .) (Note 2)

PARAMETER	SYMBOL	CONDITIONS	MIN	TYP	MAX	UNITS
<b>PIXI PORTS</b>						
Input Capacitance		All PIXI ports		20		pF
Input Resistance		All PIXI input ports except ADC mode	50	75	100	k $\Omega$
Startup Time		Between stable supplies and accessing registers			100	ms
<b>HIGH-VOLTAGE OUTPUT DRIVER CHARACTERISTICS</b>						
Maximum Output Capacitance					250	pF
Output Low Voltage, DAC Mode		Sinking 25mA, $V_{AVSSIO} = 0V$ , $AVDDIO = 10V$			$V_{AVSSIO} + 1.0$	V
Output High Voltage, DAC Mode		Sourcing 25mA, $V_{AVSSIO} = 0V$ , $AVDDIO = 10V$	$V_{AVDDIO} - 1.5$			V
Output Low Voltage, GPO Mode		Sinking 2mA, $V_{AVSSIO} = 0V$ , $AVDDIO = 10V$			$V_{AVSSIO} + 0.4$	V
Output High Voltage, GPO Mode		Sourcing 2mA, $V_{AVSSIO} = 0V$ , $AVDDIO = 10V$	$V_{AVDDIO} - 0.4$			V
Current Limit		Short to AVDDIO		75		mA
		Short to AVSSIO		75		mA

**Note 2:** Electrical specifications are production tested at  $T_A = +25^\circ C$ . Specifications over the entire operating temperature range are guaranteed by design and characterization. Typical specifications are at  $T_A = +25^\circ C$ .

**Note 3:** DC accuracy specifications are tested for single-ended ADC inputs only.

**Note 4:** The effective ADC sample rate for port X configured in mode 6, 7, or 8 is:

$$[\text{ADC sample rate per ADCCONV}] / ([\text{number of ports in modes 6,7,8}] + [1 \text{ if TMPSEL} \neq 000]) \times [2\# \text{ OF SAMPLES for port X}]$$

**Note 5:** See the *Recommended VDDIO/VSSIO Supply Selection* table for each range. For ports in modes 6, 7, 8, or 9, the voltage applied to those ports must be within the limits of their selected input range, whether in single-ended or differential mode.

**Note 6:** Specification is guaranteed by design and characterization.

**Note 7:** Switch controlled by GPI-configured port. One switch terminal connected to 0V, the other terminal connected to 5V through a 5mA current source. Timing is measured at the 2.5V transition point. Turn-on and turn-off delays are measured from the edge of the control signal to the 2.5V transition point. Turn-on and turn-off durations are measured between control signal transitions.

**Note 8:** In DAC-related modes, the rate, at which PIXI ports configured in mode 1, 3, 4, 5, 6, or 10 are refreshed, is as follows:  
 $1/(40\mu s \times [\text{number of ports in modes 1, 3, 4, 5, 6, 10}])$

**Note 9:** Typical (TYP) values represent the errors at the extremes of the given temperature range.

Typical Operating Characteristics

(T<sub>A</sub> = +25°C, unless otherwise noted.)

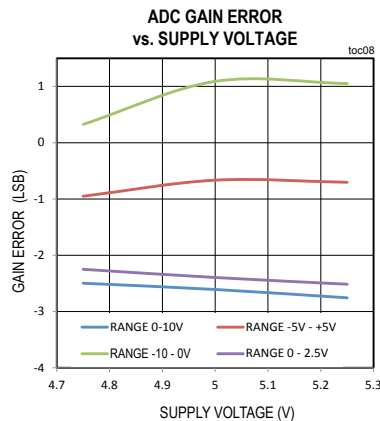
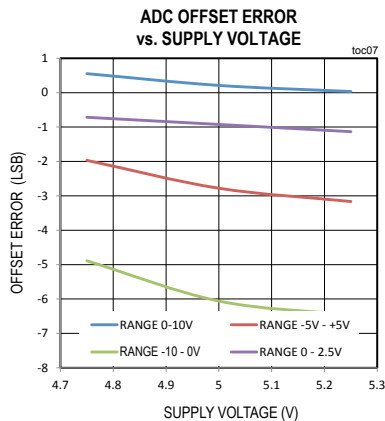
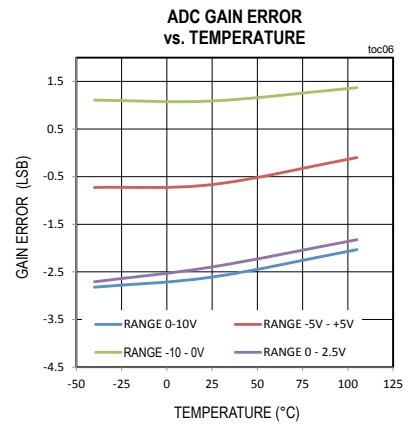
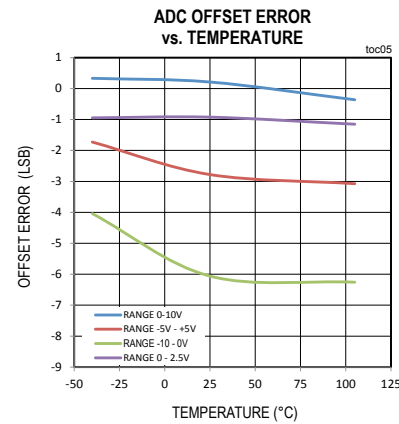
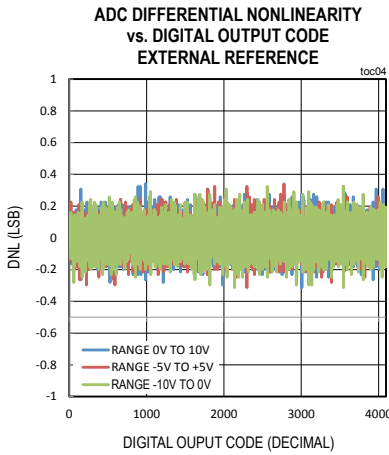
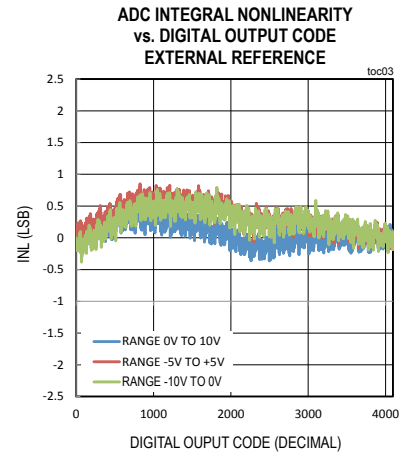
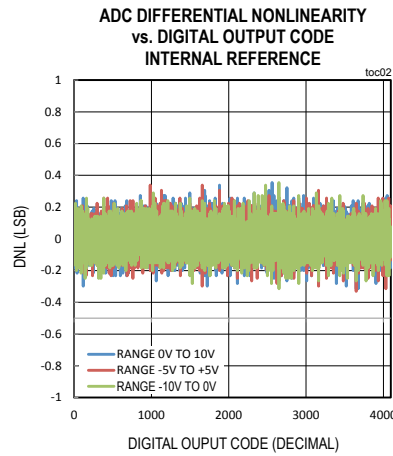
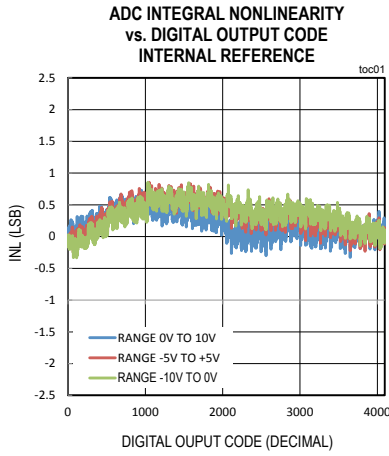

Typical Operating Characteristics (continued)

(T<sub>A</sub> = +25°C, unless otherwise noted.)

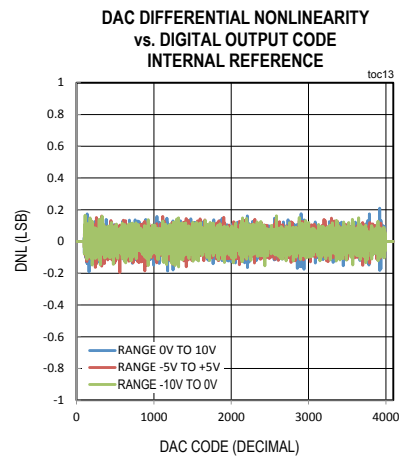
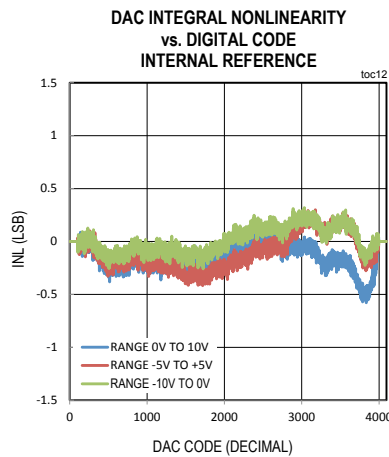
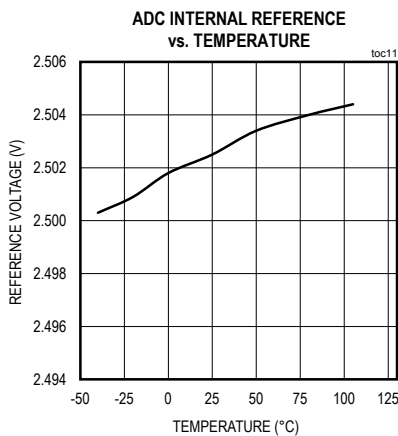
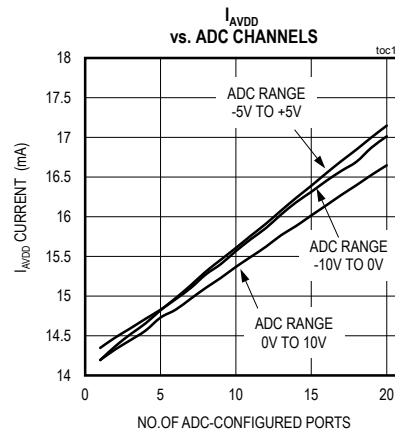
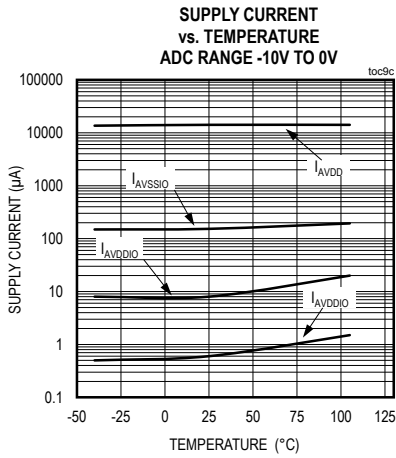
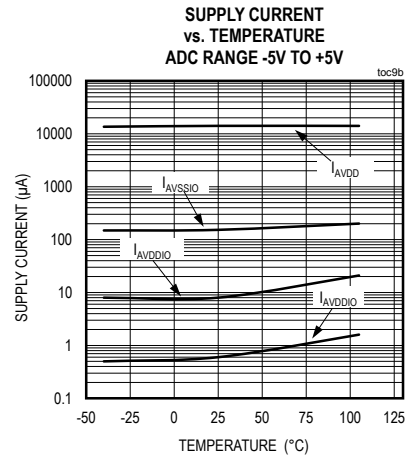
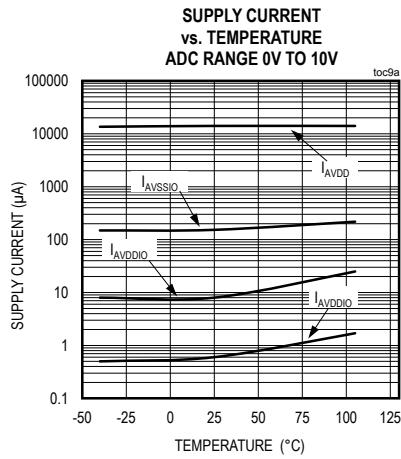

Typical Operating Characteristics (continued)

(T<sub>A</sub> = +25°C, unless otherwise noted.)

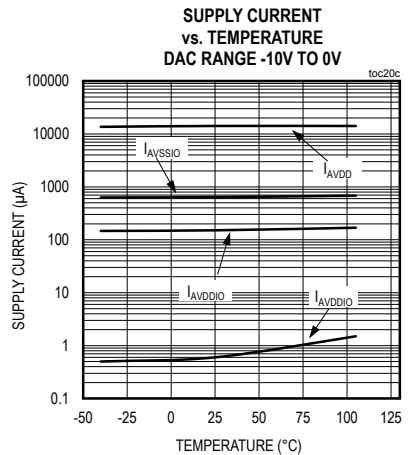
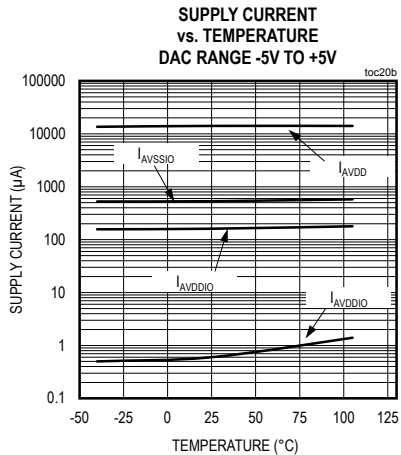
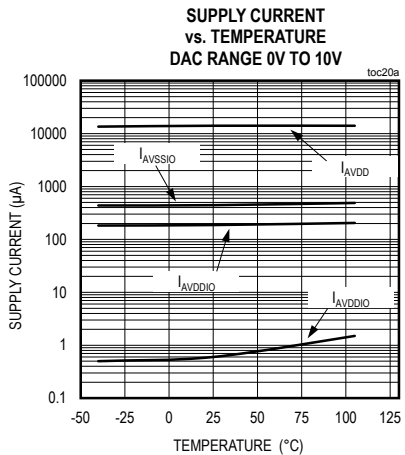
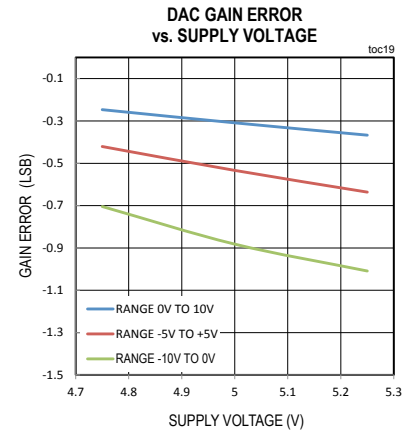
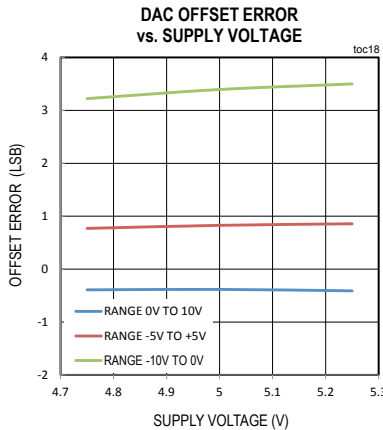
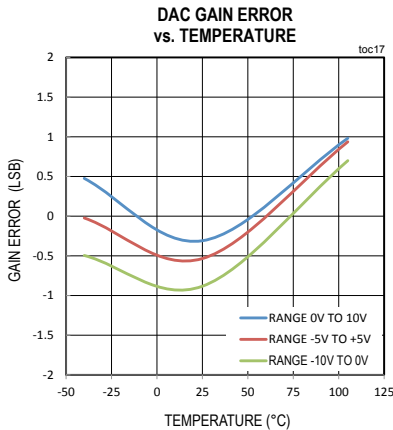
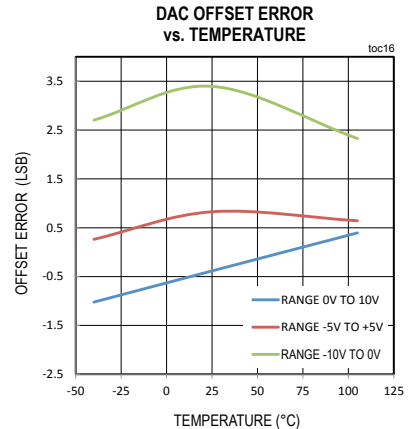
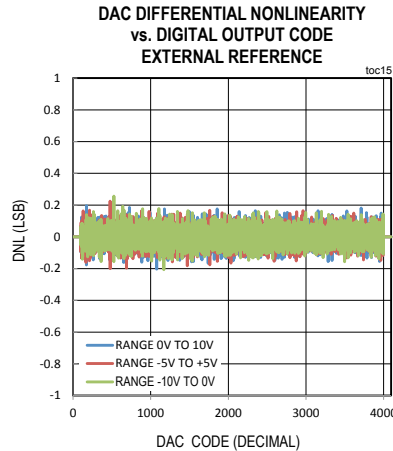
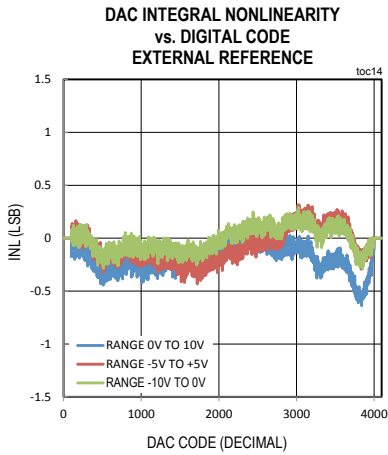

Typical Operating Characteristics (continued)

(TA = +25°C, unless otherwise noted.)

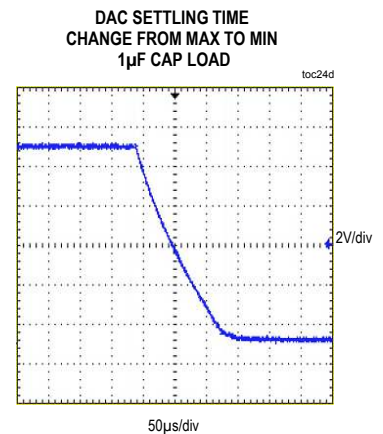
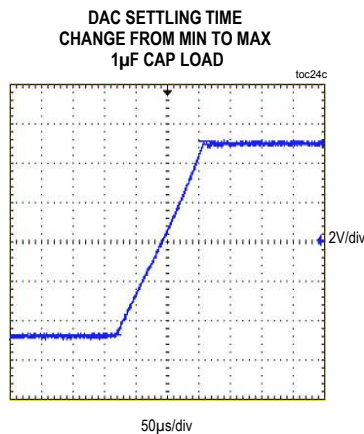
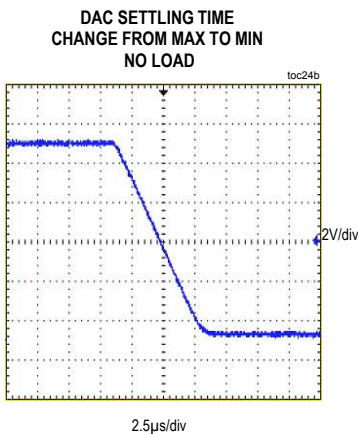
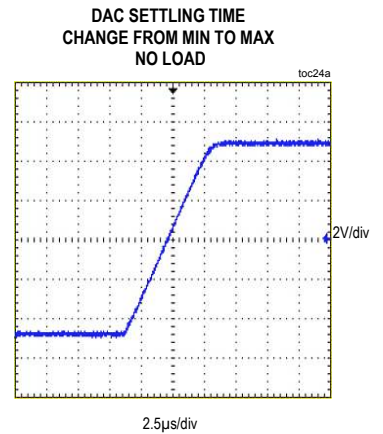
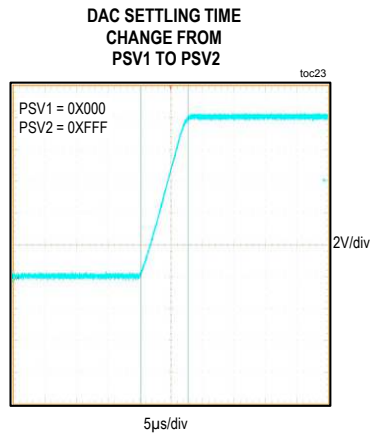
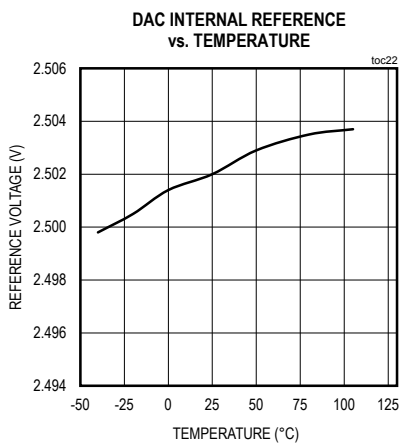
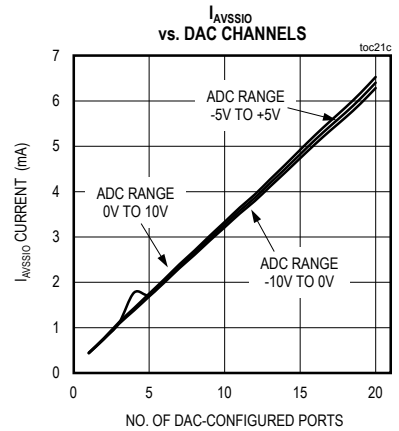
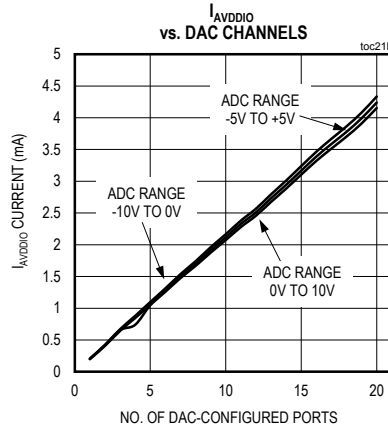
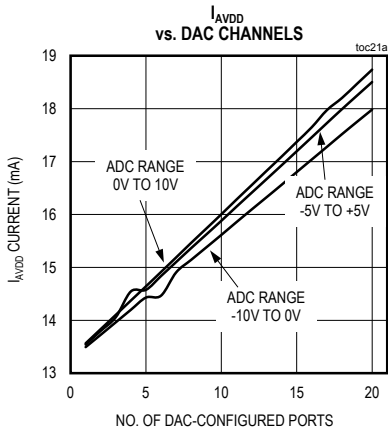



Typical Operating Characteristics (continued)

(T<sub>A</sub> = +25°C, unless otherwise noted.)

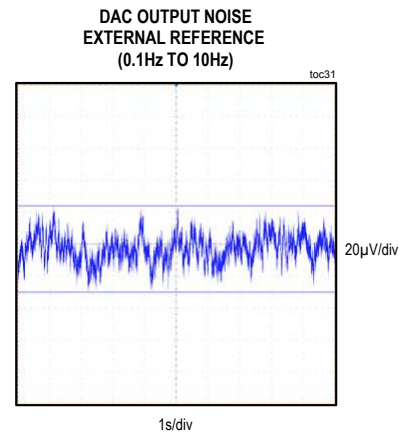
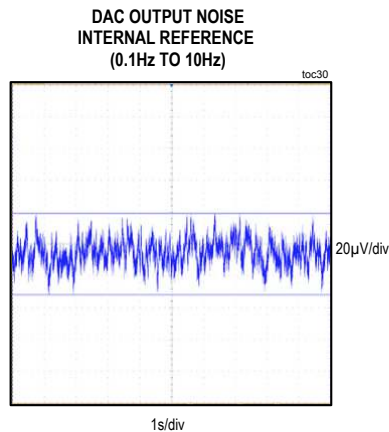
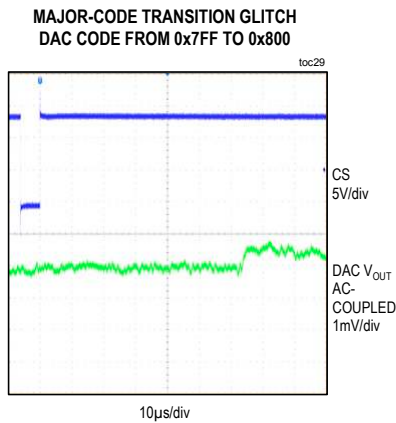
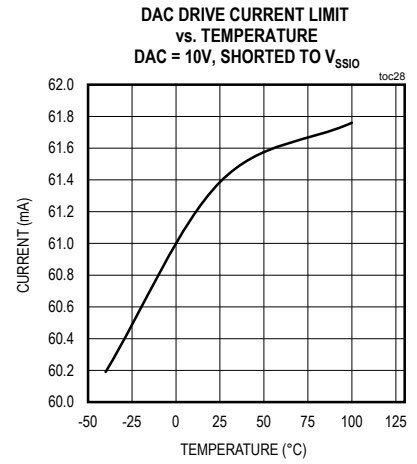
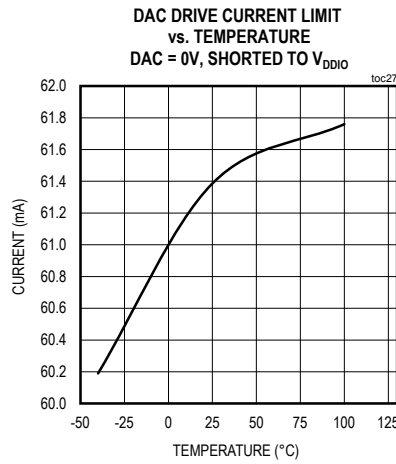
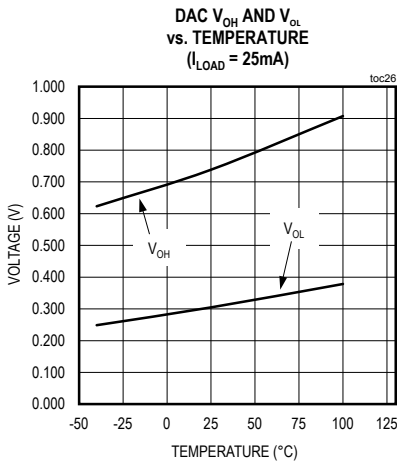
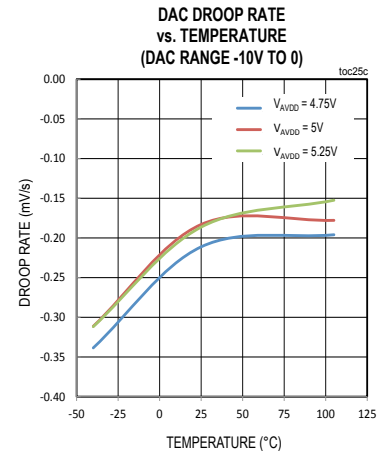
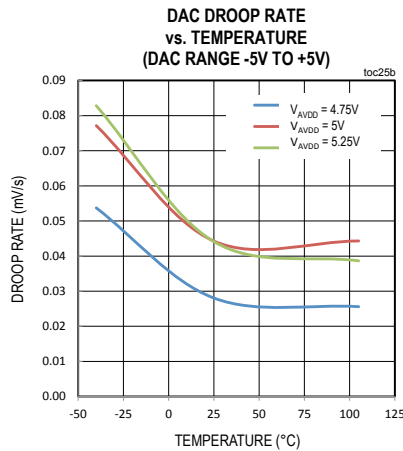
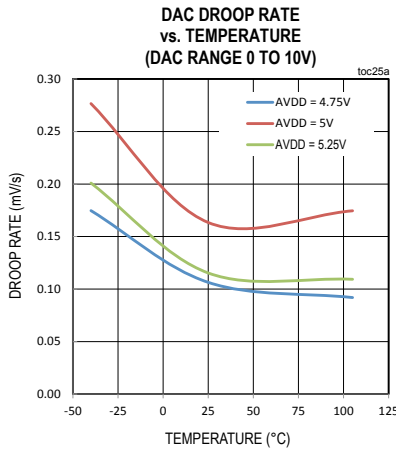

Typical Operating Characteristics (continued)

(T<sub>A</sub> = +25°C, unless otherwise noted.)

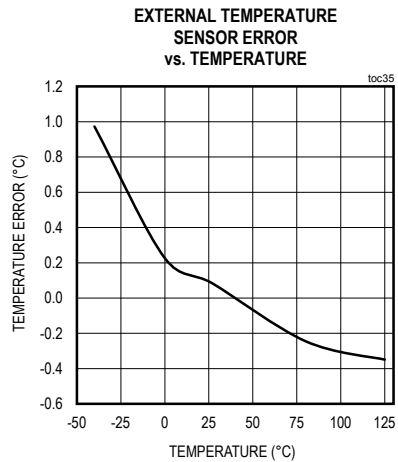
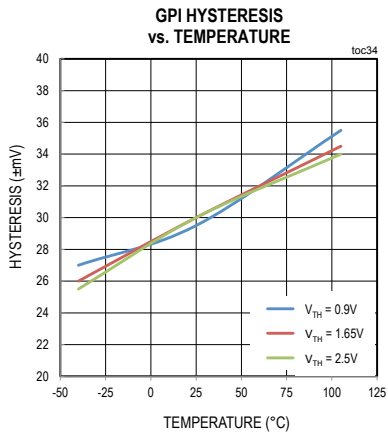
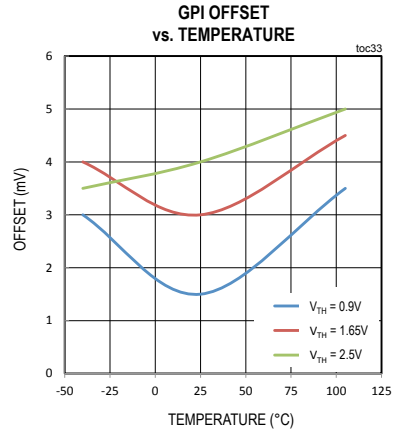
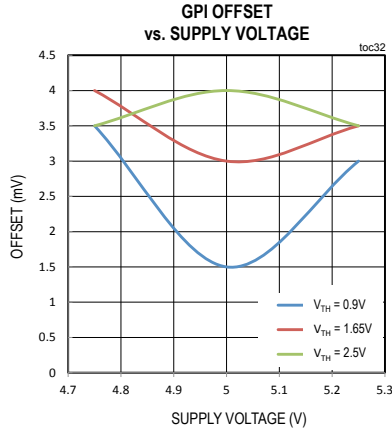

Pin Configurations

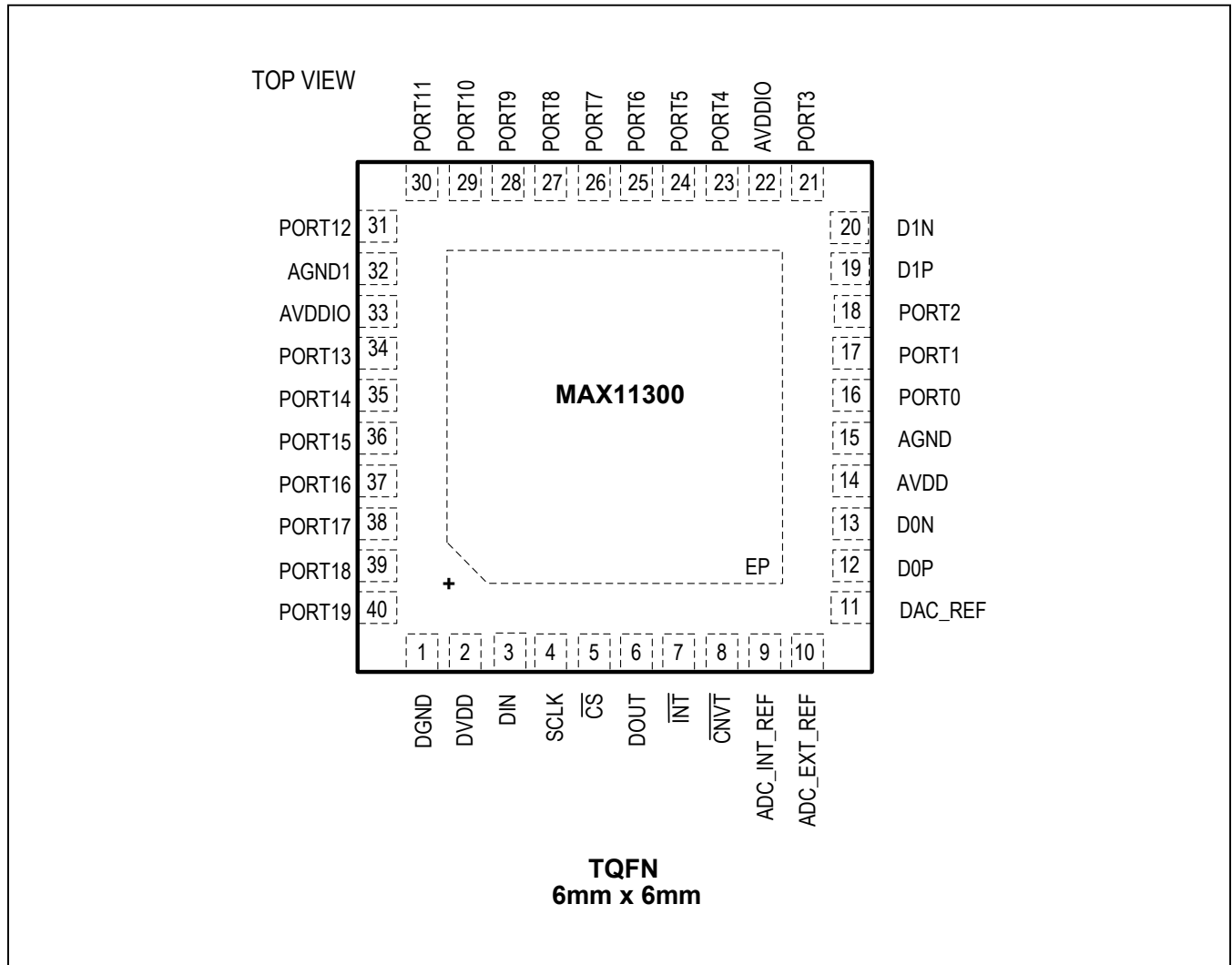

MAX11300

PIXI, 20-Port Programmable Mixed-Signal I/O with 12-Bit ADC, 12-Bit DAC, Analog Switches, and GPIO

Pin Configurations (continued)

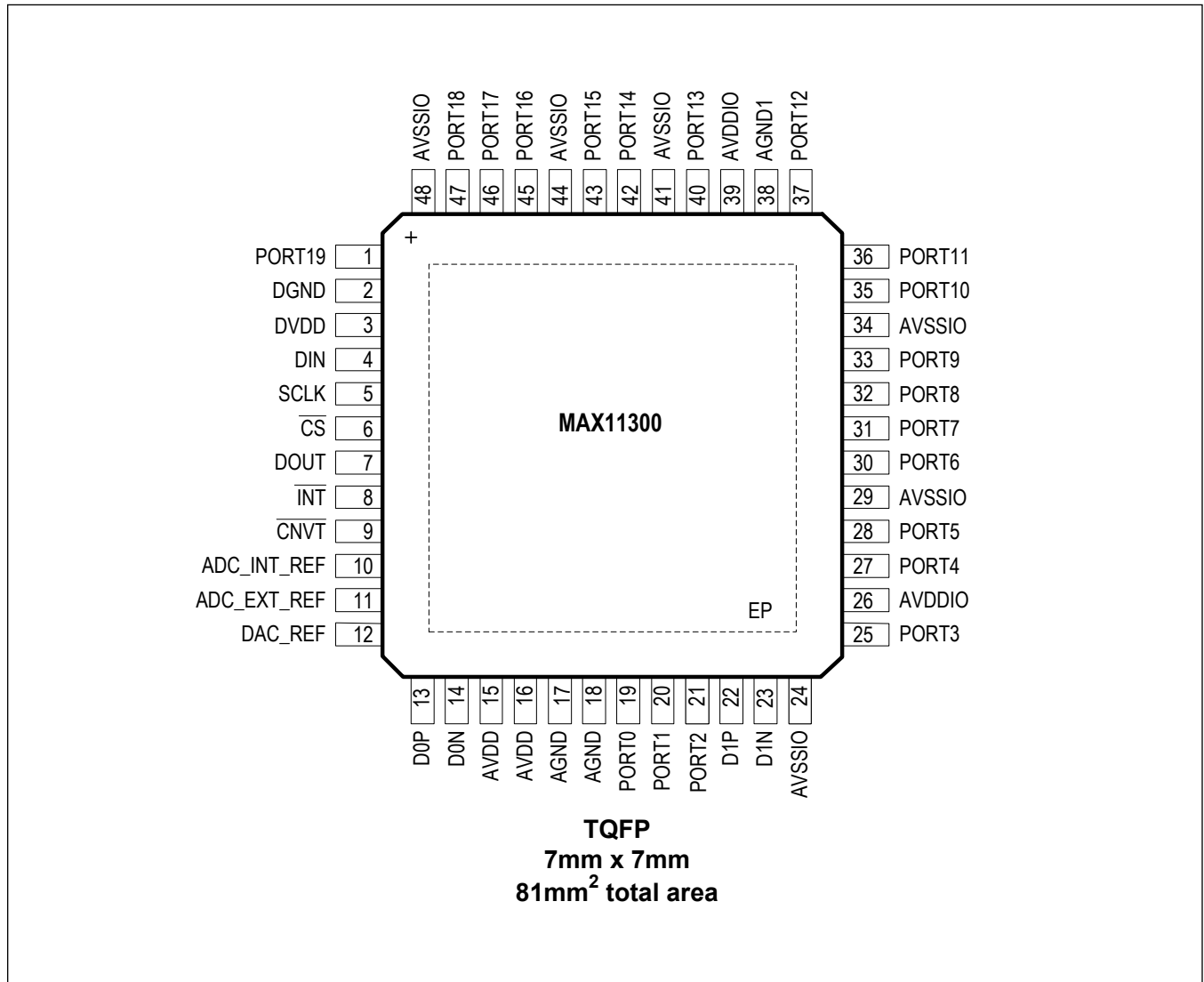

## Pin Description

PIN		NAME	FUNCTION
TQFN	TQFP		
1	2	DGND	Digital Ground
2	3	DVDD	Positive Digital Supply
3	4	DIN	Serial Interface Data Input
4	5	SCLK	Serial Interface Clock Input
5	6	$\overline{\text{CS}}$	Serial Interface Chip-Select-Active Low
6	7	DOUT	Serial Interface Data Output
7	8	$\overline{\text{INT}}$	Interrupt Open-Drain Output. Active low.
8	9	$\overline{\text{CNVT}}$	ADC Trigger Control Input. Active low.
9	10	ADC_INT_REF	ADC Internal Voltage Reference Output. Connect a bypass capacitor at this pin (4.7 $\mu$ F to 10 $\mu$ F).
10	11	ADC_EXT_REF	ADC External Voltage Reference Input. Connect a bypass capacitor at this pin (4.7 $\mu$ F recommended).
11	12	DAC_REF	DAC External/Internal Voltage Reference Input. Connect a bypass capacitor at this pin (4.7 $\mu$ F to 10 $\mu$ F).
12	13	D0P	1st External Temperature Sensor Positive Input
13	14	D0N	1st External Temperature Sensor Negative Input
14	15, 16	AVDD	Positive Analog Supply. For TQFP, connect both pins to AVDD.
15	17, 18	AGND	Analog Ground. For TQFP, connect both pins to AGND.
16	19	PORT0	Configurable Mixed-Signal Port 0
17	20	PORT1	Configurable Mixed-Signal Port 1
18	21	PORT2	Configurable Mixed-Signal Port 2
19	22	D1P	2nd External Temperature Sensor Positive Input
20	23	D1N	2nd External Temperature Sensor Negative Input
21	25	PORT3	Configurable Mixed-Signal Port 3
22, 33	26, 39	AVDDIO	Analog Positive Supply For Mixed-Signal Ports. Connect both pins to AVDDIO.
23	27	PORT4	Configurable Mixed-Signal Port 4
24	28	PORT5	Configurable Mixed-Signal Port 5
25	30	PORT6	Configurable Mixed-Signal Port 6
26	31	PORT7	Configurable Mixed-Signal Port 7
27	32	PORT8	Configurable Mixed-Signal Port 8
28	33	PORT9	Configurable Mixed-Signal Port 9
29	35	PORT10	Configurable Mixed-Signal Port 10
30	36	PORT11	Configurable Mixed-Signal Port 11
31	37	PORT12	Configurable Mixed-Signal Port 12
32	38	AGND1	Analog Ground.

## Pin Description (continued)

PIN		NAME	FUNCTION
TQFN	TQFP		
34	40	PORT13	Configurable Mixed-Signal Port 13
35	42	PORT14	Configurable Mixed-Signal Port 14
36	43	PORT15	Configurable Mixed-Signal Port 15
37	45	PORT16	Configurable Mixed-Signal Port 16
38	46	PORT17	Configurable Mixed-Signal Port 17
39	47	PORT18	Configurable Mixed-Signal Port 18
40	1	PORT19	Configurable Mixed-Signal Port 19
—	24, 29, 34, 41, 44, 48	AVSSIO	Analog Negative Supply for Mixed-Signal Ports. For TQFP, connect all pins to AVSSIO..
—	—	EP	Exposed Pad. For TQFN, connect EP to AVSSIO. For TQFP, connect EP to AGND.

Typical Application Circuits

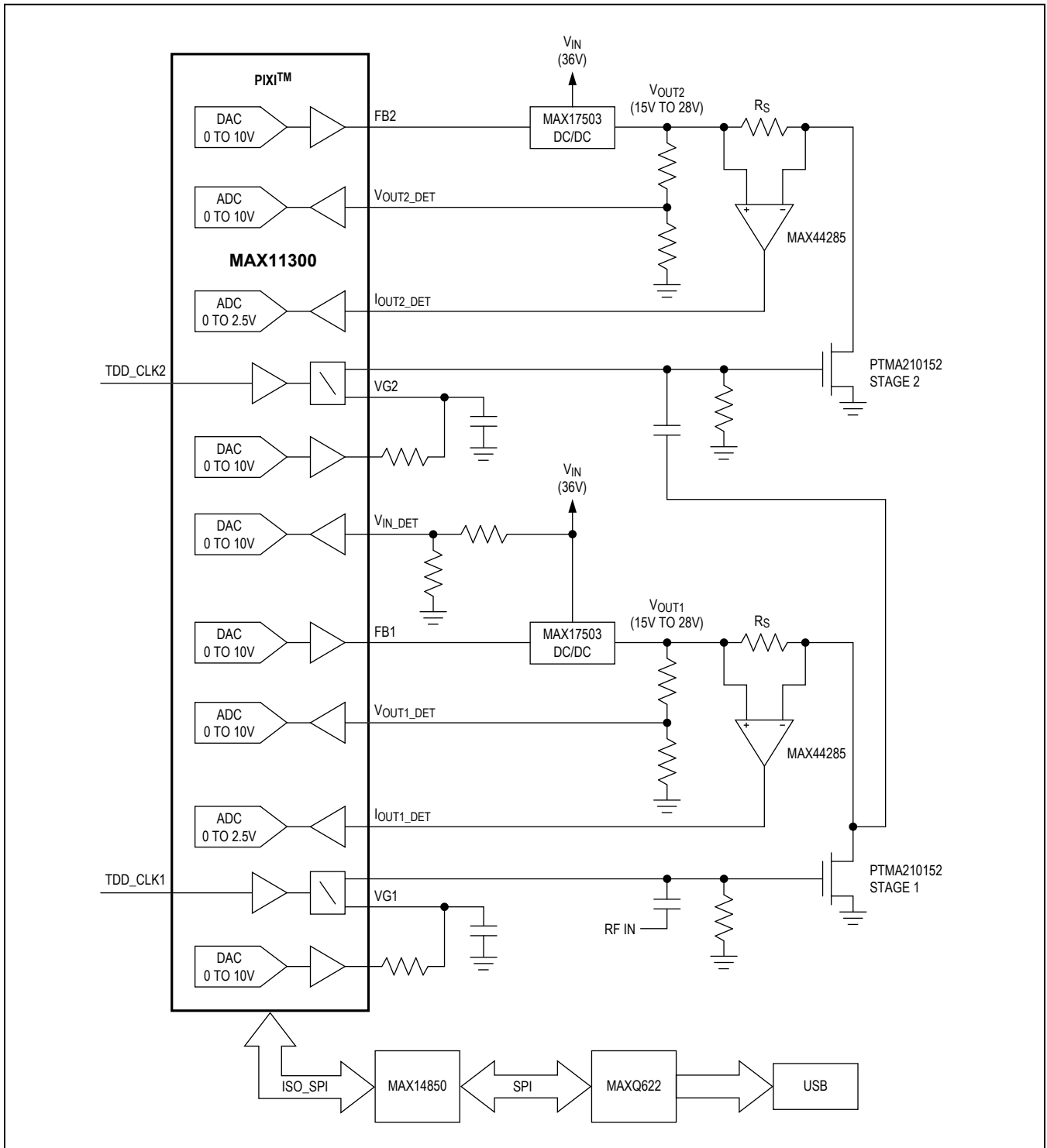

PA Biasing Solution

Typical Application Circuits (continued)

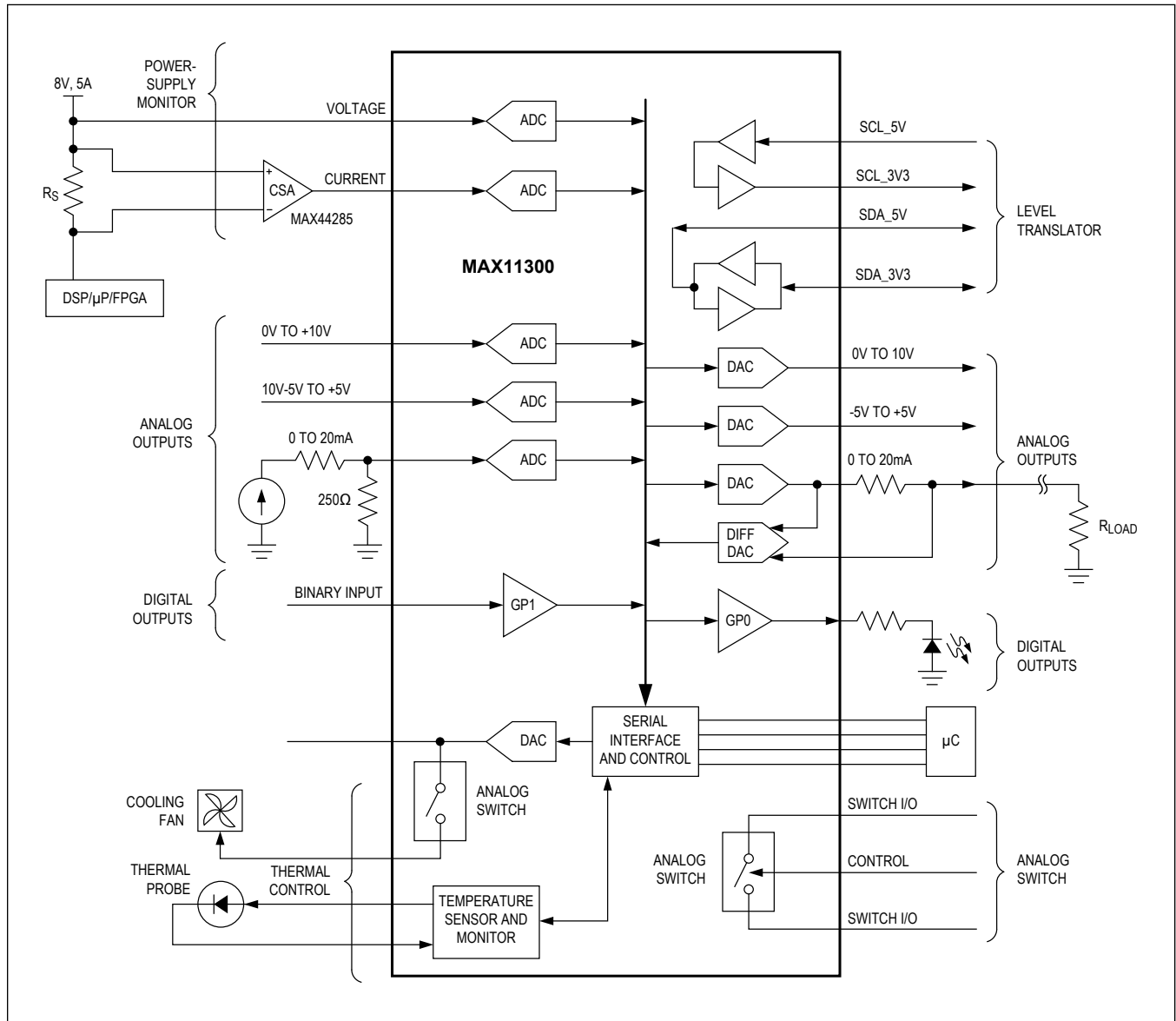

Control and Monitoring Solution



## Detailed Description

### Functional Overview

The MAX11300 has 20 configurable mixed-signal I/O ports. Each port is independently configured as a DAC output, an ADC input, a GPI, a GPO, or an analog switch terminal. User-controllable parameters are available for each of those configurations. The device offers one internal and two external temperature sensors. The serial interface operates as a SPI Mode 0 interface.

The DAC is used to drive out a voltage defined by the DAC data register of the DAC-configured ports. The DAC uses either an internal or external voltage reference. The selection of the voltage reference is set for all the ports and cannot be configured on a port-by-port basis.

The ADC converts voltages applied to the ADC-configured ports. The ADC can operate in single-ended mode or in differential mode, by which any two ports can form a differential pair. The port configured as the negative input of the ADC can be used by more than one differential ADC input pairs. The ADC uses either an internal or external voltage reference. In some configurations, the ADC uses the DAC voltage reference. The ADC voltage reference selection can be configured on a port-by-port basis.

Interrupts provide the host with the occurrence of user-selected events through the configuration of an interrupt mask register.

### ADC Operations

The ADC is a 12-bit, low-power, successive approximation analog-to-digital converter, capable of sampling a single input at up to 400kps. The ADC's conversion rate can be programmed to 400kps, 333kps, 250kps, or 200kps. The default conversion rate setting is 200kps. Each ADC-configured port can be programmed for one of four input voltage ranges: 0V to +10V, -5V to +5V, -10V to 0V, and 0V to +2.5V. The ADC uses the internal ADC 2.5V voltage reference, the external ADC voltage reference, or, in some cases, the DAC voltage reference. The voltage reference can be selected on a port-by-port basis.

### ADC Control

The ADC can be triggered using an external signal  $\overline{\text{CNVT}}$  or from a control bit.  $\overline{\text{CNVT}}$  is active-low and must remain low for a minimal duration of 0.5  $\mu\text{s}$  to trigger a conversion. Four configurations are available:

- Idle mode (default setting).
- Single sweep mode. The ADC sweeps sequentially the ADC-configured ports, from the lowest index port to the highest index port, once  $\overline{\text{CNVT}}$  is asserted.
- Single conversion mode. The ADC performs a single conversion at the current port in the series of ADC-configured ports when  $\overline{\text{CNVT}}$  is asserted.
- Continuous sweep mode. The ADC continuously sweeps the ADC-configured ports. The  $\overline{\text{CNVT}}$  port has no effect in this mode.

### ADC Averaging Function

ADC-configured ports can be configured to average blocks of 2, 4, 8, 16, 32, 64, or 128 conversion results. The corresponding ADC data register is updated only when the averaging is completed, thus decreasing the throughput proportionally. If the number of samples to average is modified for a given port, the content of the ADC data register for that port is cleared before starting to average the new block of samples.

### ADC Mode Change

When users change the ADC active mode (continuous sweep, single sweep, or single conversion), the ADC data registers are reset. However, ADC data registers retain content when the ADC is changed to idle mode.

### ADC Configurations

The ADC can operate in single-ended, differential, or pseudo-differential mode. In single-ended mode, the PIXI port is the positive input to the ADC while the negative input is grounded internally (Figure 3). In differential mode (Figure 4), any pair of PIXI ports can be configured as inputs to the differential ADC. In pseudo-differential mode (Figure 5), one PIXI port produces the voltage applied to the negative input of the ADC while another PIXI port forms the positive input.

The ADC data format is straight binary in single-ended mode, and two's complement in differential and pseudo-differential modes.

### DAC Operations

The MAX11300 uses a 12-bit DAC, which operates at the rate of 40 $\mu\text{s}$  per port. Since up to 20 ports can be configured in DAC-related modes, the minimum refresh rate per port is 1.25kHz.

No external component is required to set the offset and gain of the DAC drivers. The PIXI port driver features a wide output voltage range of  $\pm 10\text{V}$  and high current capability with dedicated power supplies (AVDDIO, AVSSIO).

The DAC uses either the internal or external voltage reference. Unlike the ADC, the DAC voltage reference cannot be configured on a port-by-port basis. DAC mode configuration is illustrated in Figure 6.

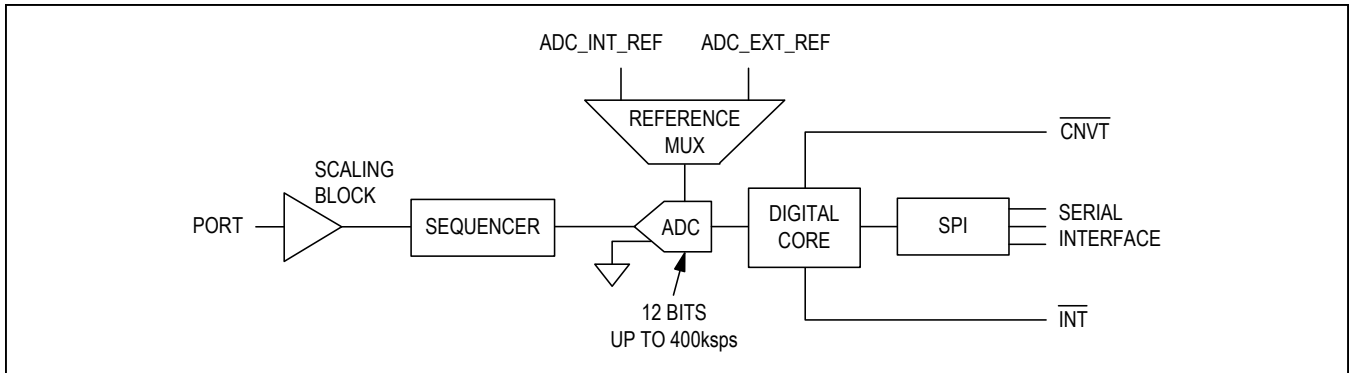

Figure 3. ADC with Single-Ended Input

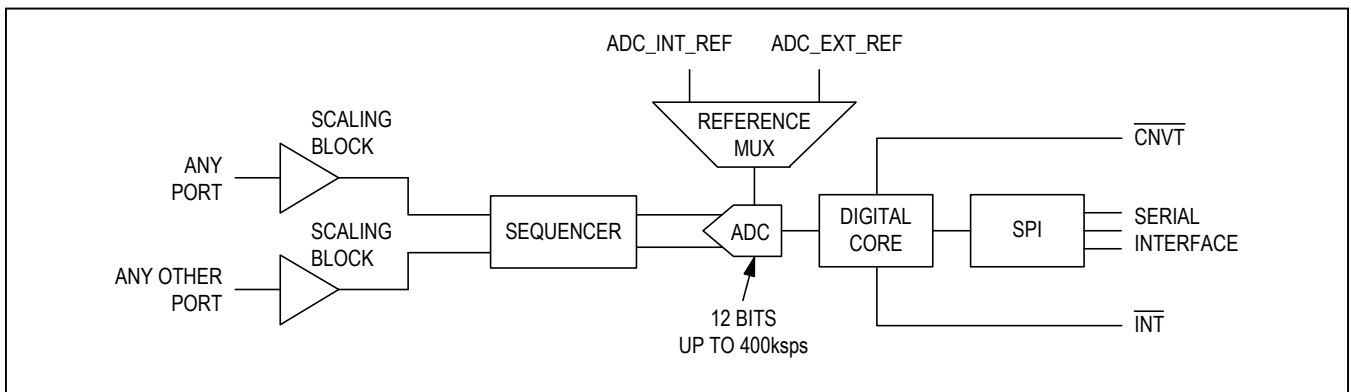

Figure 4. ADC with Differential Inputs

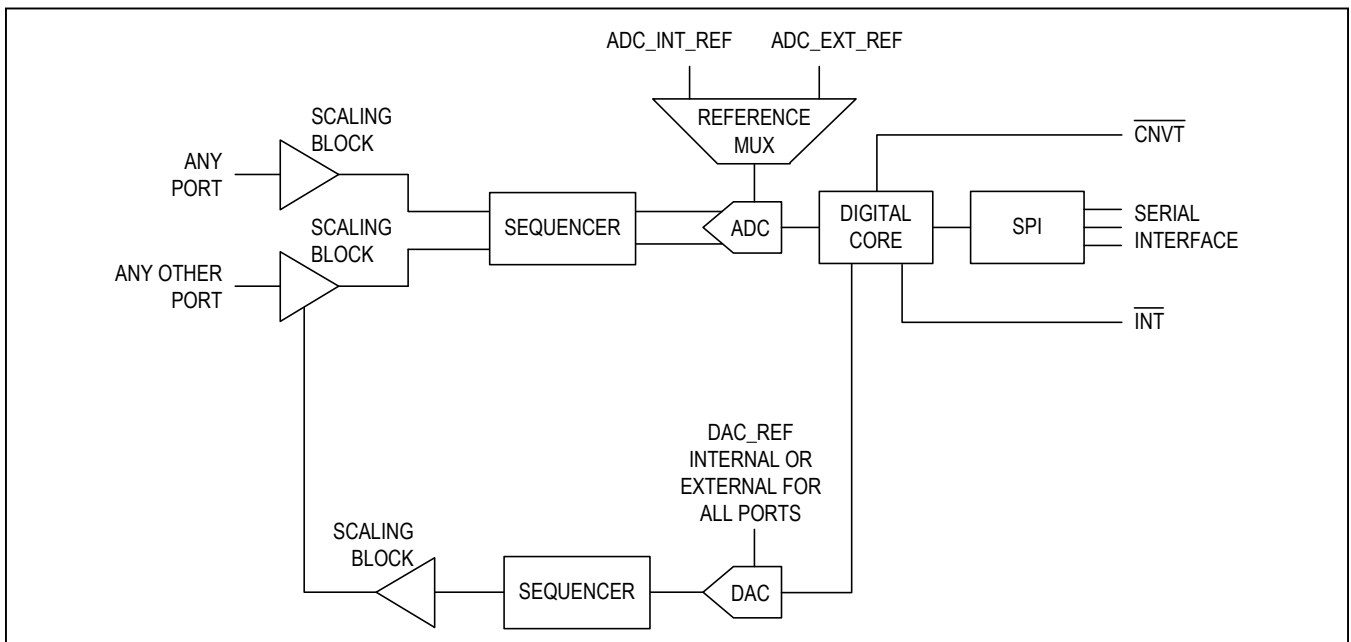

Figure 5. ADC with Pseudo-Differential Input Set by DAC