



Chipsmall Limited consists of a professional team with an average of over 10 year of expertise in the distribution of electronic components. Based in Hongkong, we have already established firm and mutual-benefit business relationships with customers from,Europe,America and south Asia,supplying obsolete and hard-to-find components to meet their specific needs.

With the principle of "Quality Parts,Customers Priority,Honest Operation,and Considerate Service",our business mainly focus on the distribution of electronic components. Line cards we deal with include Microchip,ALPS,ROHM,Xilinx,Pulse,ON,Everlight and Freescale. Main products comprise IC,Modules,Potentiometer,IC Socket,Relay,Connector.Our parts cover such applications as commercial,industrial, and automotives areas.

We are looking forward to setting up business relationship with you and hope to provide you with the best service and solution. Let us make a better world for our industry!



## Contact us

Tel: +86-755-8981 8866 Fax: +86-755-8427 6832

Email & Skype: info@chipsmall.com Web: www.chipsmall.com

Address: A1208, Overseas Decoration Building, #122 Zhenhua RD., Futian, Shenzhen, China





# MAX11600–MAX11617 Evaluation System

## General Description

The MAX11600–MAX11617 evaluation system (EV system) includes one master board and one of six EV kit daughter boards. The EV system also includes Windows® 2000-, Windows XP®, and Windows Vista®-compatible software that provides a simple graphical user interface (GUI) for exercising the features of the MAX11600–MAX11617. The MAX116XXI2CMB+ master board connects to a PC USB port and allows the transfer of I<sup>2</sup>C commands to the corresponding EV kit daughter board.

The EV kit daughter boards are fully assembled and tested PCBs that demonstrate the capabilities of the MAX11600–MAX11617 4-/8-/12-channel, 8-/10-/12-bit, 3V/5V, low-power, high-speed I<sup>2</sup>C ADCs with internal reference.

Each EV kit daughter board evaluates three different ADCs, but only the ADC referenced in the EV kit daughter board part name is installed on the board. Contact the factory for free samples of the other pin-compatible ADCs to evaluate these devices or to order individual boards.

## Features

- ◆ 4/8/12 ADC Channel Inputs
- ◆ 1.7MHz I<sup>2</sup>C Interface
- ◆ EV Kit Daughter Board Powered by the Master Board
- ◆ Windows 2000-, Windows XP-, and Windows Vista (32-Bit)-Compatible Software
- ◆ Time Domain, Frequency Domain, and Histogram Plotting in the EV System Software
- ◆ Frequency, RMS, Min, Max, and Average DC Calculations in the EV System Software
- ◆ Collects Up to 1 Mega Samples
- ◆ On-Board Voltage Reference
- ◆ USB-PC Connection
- ◆ Proven PCB Layout
- ◆ Fully Assembled and Tested

Evaluates: MAX11600–MAX11617

## Ordering Information/Selector Guide

PART	COMPATIBLE ADC	DESCRIPTION
MAX11612EVSYS+	MAX11612EUA+*	12-bit, 5V supply, 4-channel, 4.096V internal reference
	MAX11606EUA+	10-bit, 5V supply, 4-channel, 4.096V internal reference
	MAX11600EKA+	8-bit, 5V supply, 4-channel, 4.096V internal reference
MAX11613EVSYS+	MAX11613EUA+*	12-bit, 3V supply, 4-channel, 2.048V internal reference
	MAX11607EUA+	10-bit, 3V supply, 4-channel, 2.048V internal reference
	MAX11601EKA+	8-bit, 3V supply, 4-channel, 2.048V internal reference
MAX11614EVSYS+	MAX11614EEE+*	12-bit, 5V supply, 8-channel, 4.096V internal reference
	MAX11608EEE+	10-bit, 5V supply, 8-channel, 4.096V internal reference
	MAX11602EEE+	8-bit, 5V supply, 8-channel, 4.096V internal reference
MAX11615EVSYS+	MAX11615EEE+*	12-bit, 3V supply, 8-channel, 2.048V internal reference
	MAX11609EEE+	10-bit, 3V supply, 8-channel, 2.048V internal reference
	MAX11603EEE+	8-bit, 3V supply, 8-channel, 2.048V internal reference
MAX11616EVSYS+	MAX11616EEE+*	12-bit, 5V supply, 12-channel, 4.096V internal reference
	MAX11610EEE+	10-bit, 5V supply, 12-channel, 4.096V internal reference
	MAX11604EEE+	8-bit, 5V supply, 12-channel, 4.096V internal reference
MAX11617EVSYS+	MAX11617EEE+*	12-bit, 3V supply, 12-channel, 2.048V internal reference
	MAX11611EEE+	10-bit, 3V supply, 12-channel, 2.048V internal reference
	MAX11605EEE+	8-bit, 3V supply, 12-channel, 2.048V internal reference

+Denotes lead(Pb)-free and RoHS compliant.

\*Default ADC installed on the EV kit daughter board.

Windows, Windows XP, and Windows Vista are registered trademarks of Microsoft Corp.



# MAX11600–MAX11617 Evaluation System

**Evaluates: MAX11600–MAX11617**

## Component Lists

### MAX116XX I<sup>2</sup>C Master Board

DESIGNATION	QTY	DESCRIPTION
C1–C17	17	47nF ±10%, 16V, X7R ceramic capacitors (0603) Murata GRM188R71C473K
C18–C33	16	1nF ±10%, 50V, X7R ceramic capacitors (0603) Murata GRM188R71H102K
C34, C52	2	1µF ±10%, 16V X5R ceramic capacitors (0603) Murata GRM188R61C105K
C35, C42, C46, C50, C53–C56, C60, C61, C62, C64, C65, C66	14	0.1µF ±10%, 16V X7R ceramic capacitors (0603) TDK C1608X7R1C104K
C36, C39	2	0.01µF ±10%, 50V, X7R ceramic capacitors (0603) Murata GRM188R71H103K
C37, C44, C45	3	10pF ±5%, 50V C0G ceramic capacitors (0603) Murata GRM1885C1H100J
C38	1	15pF ±5%, 50V C0G ceramic capacitor (0603) Murata GRM1885C1H150J
C40, C41	2	39pF ±5%, 50V C0G ceramic capacitors (0603) Murata GRM1885C1H390J
C43, C49, C51, C63, C67, C68, C70	7	10µF ±10%, 25V, X5R ceramic capacitors, (1206) Murata GRM31CR61E106K
C47, C48, C69	3	4.7µF ±10%, 25V X5R ceramic capacitors (1206) Murata GRM31CR71E475M
C57	1	0.033µF ±10%, 16V X5R ceramic capacitor (0603) Taiyo Yuden EMK107BJ333KA
C58, C59	2	22pF ±5%, 50V C0G ceramic capacitors (0603) Murata GRM1885C1H220J

DESIGNATION	QTY	DESCRIPTION
DGND, DVDD	2	Banana jacks, uninsulated
J1	1	2 x 10 right-angle male header
J2	0	Not installed, 24-pin dual-row (2 x 12) header
J3	1	USB type-B right-angle PC-mount receptacle
JSPI	0	Not installed, 6-pin header (1 x 6)
JTAG1	1	6-pin header (1 x 6)
JTAG2	1	10-pin dual-row (2 x 5) header
JU1–JU4	0	Not installed, 2-pin headers
JU5	0	Not installed, 3-pin header
JU6–JU9	4	2-pin headers
LED1, LED2, LED3	3	Red LEDs (0603)
L1	1	Ferrite bead TDK MMZ1608R301A (0603)
R1, R3, R4, R19, R21–R24	8	4.7kΩ ±5% resistors (0603)
R2, R16, R17, R18	4	100Ω ±5% resistors (0603)
R5	1	390Ω ±5% resistor (0603)
R6, R7, R8, R27, R36	5	10kΩ ±5% resistors (0603)
R9, R10, R11	3	200Ω ±5% resistors (0603)
R12, R14, R25, R29	4	10Ω ±5% resistors (0603)
R13	1	150Ω ±5% resistor (0603)
R15	1	56Ω ±5% resistor (0603)
R20, R28	2	680Ω ±5% resistors (0603)
R26	1	1kΩ ±5% resistor (0603)
R30	1	18.7kΩ ±1% resistor (0603)
R31, R43, R44, R46, R50	5	10kΩ ±1% resistors (0603)

# MAX11600–MAX11617 Evaluation System

## Component Lists (continued)

### MAX116XX I<sup>2</sup>C Master Board

Evaluates: MAX11600–MAX11617

DESIGNATION	QTY	DESCRIPTION
R32, R33	2	27Ω ±5% resistors (0603)
R34	1	1.5kΩ ±5% resistor (0603)
R35	1	2.2kΩ ±5% resistor (0603)
R37–R41	0	Not installed, resistors—short (PC trace) (0603)
R42, R45, R51	3	100kΩ ±5% resistors (0603)
R47	1	20kΩ ±1% resistor (0603)
R48	1	470Ω ±5% resistor (0603)
R49	1	30kΩ ±1% resistor (0603)
S1	1	4-position DIP switch
U1	1	Spartan 3A FPGA (144 TQFP) Xilinx XC3S50A-4TQG144I
U2	1	Microcontroller (68 QFN-EP*) Maxim MAXQ2000-RAX+
U3	0	Not installed, 4Mb PROM Flash (20 TSSOP) Xilinx XCF04SVOG20C
U4	1	SPI Flash (8 SO) Atmel AT45DB161D-SU
U5	1	1M x 16 SRAM (48 TSOP) Cypress CY62167DV30LL-55ZXI

DESIGNATION	QTY	DESCRIPTION
U6, U7, U11	3	LDOs (16 TSSOP-EP*) Maxim MAX1793EUE50+
U8	1	USB-to-UART converter (32 TQFP)
U9	1	93C46-type 3-wire EEPROM 16-bit architecture (8 SO)
U10	1	LDO (6 SOT23) Maxim MAX1983EUT+
Y1	1	50MHz oscillator
Y2	1	6MHz crystal Hong Kong X'tals SSL6000N1HK188F0-0
Y3	0	Not installed, crystal
Y4	1	16MHz crystal Hong Kong X'tals SSM16000N1HK188F0-0
—	1	USB high-speed A-to-B cable, 6ft
—	4	Shunts
—	1	PCB: MAX116XX I <sup>2</sup> C MASTER BOARD+

\*EP = Exposed pad.

### MAX11612 EV Kit Daughter Board

DESIGNATION	QTY	DESCRIPTION
A1N0–A1N3	4	Yellow multipurpose test points
AVDD_EXT	1	Red multipurpose test point
C1, C7	2	1μF ±10%, 16V X5R ceramic capacitors (0603) Murata GRM188R61C105K
C2, C6	2	10μF ±10%, 6.3V X5R ceramic capacitors (0603) Murata GRM188R60J106M
C5, C8, C9, C10	4	0.1μF ±10%, 16V X7R ceramic capacitors (0603) TDK C1608X7R1C104K
C15, C20, C25, C30	0	Not installed, ceramic capacitors (0603)
D1	1	Red LED (0603)
D2	1	Yellow LED (0603)
GND	5	Black multipurpose test points

DESIGNATION	QTY	DESCRIPTION
J1	1	2 x 10 right-angle female header
J2	1	16-pin dual-row (2 x 8) header
JU1, JU2, JU4	3	3-pin headers
JU3	1	4-pin header
JU5–JU9	5	2-pin headers
REF, SCL, SDA, +5V	4	White multipurpose test points
R1, R4, R7, R10	4	0Ω ±5% resistors (0603)
R35, R36	2	1kΩ ±5% resistors (0603)
R37	1	2kΩ ±5% resistor (0603)
R38, R39	2	470Ω ±5% resistors (0603)
U1	1	12-bit ADC (8 μMAX®) Maxim MAX11612EUA+
U3	1	Voltage reference (8 SO) Maxim MAX6126AASA25+
—	9	Shunts
—	1	PCB: MAX11612 EVALUATION KIT+

μMAX is a registered trademark of Maxim Integrated Products, Inc.

# MAX11600–MAX11617 Evaluation System

DESIGNATION	QTY	DESCRIPTION
AIN0–AIN3	4	Yellow multipurpose test points
AVDD_EXT	1	Red multipurpose test point
C1, C7	2	1 $\mu$ F $\pm$ 10%, 16V X5R ceramic capacitors (0603) Murata GRM188R61C105K
C2, C6	2	10 $\mu$ F $\pm$ 10%, 6.3V X5R ceramic capacitors (0603) Murata GRM188R60J106M
C5, C8, C9, C10	4	0.1 $\mu$ F $\pm$ 10%, 16V X7R ceramic capacitors (0603) TDK C1608X7R1C104K
C15, C20, C25, C30	0	Not installed, ceramic capacitors (0603)
D1	1	Red LED (0603)
D2	1	Yellow LED (0603)
GND	5	Black multipurpose test point
J1	1	2 x 10 right-angle female header

DESIGNATION	QTY	DESCRIPTION
AIN0–AIN7	8	Yellow multipurpose test points
AVDD_EXT	1	Red multipurpose test point
C1, C7	2	1 $\mu$ F $\pm$ 10%, 16V X5R ceramic capacitors (0603) Murata GRM188R61C105K
C2, C6	2	10 $\mu$ F $\pm$ 10%, 6.3V X5R ceramic capacitors (0603) Murata GRM188R60J106M
C5, C8, C9, C10	4	0.1 $\mu$ F $\pm$ 10%, 16V X7R ceramic capacitors (0603) TDK C1608X7R1C104K
C15, C20, C25, C30, C35, C40, C45, C50	0	Not installed, ceramic capacitors (0603)
D1	1	Red LED (0603)
D2	1	Yellow LED (0603)
GND	7	Black multipurpose test points
J1	1	2 x 10 right-angle female header

## MAX11613 EV Kit Daughter Board

DESIGNATION	QTY	DESCRIPTION
J2	1	16-pin dual-row (2 x 8) header
JU1, JU2, JU4	3	3-pin headers
JU3	1	4-pin header
JU5–JU9	5	2-pin headers
REF, SCL, SDA, 3.6V	4	White multipurpose test points
R1, R4, R7, R10	4	0 $\Omega$ $\pm$ 5% resistors (0603)
R35, R36	2	1k $\Omega$ $\pm$ 5% resistors (0603)
R37	1	2k $\Omega$ $\pm$ 5% resistor (0603)
R38, R39	2	470 $\Omega$ $\pm$ 5% resistors (0603)
U1	1	12-bit ADC (8 $\mu$ MAX) Maxim MAX11613EUA+
U3	1	Voltage reference (8 SO) Maxim MAX6126AASA25+
—	9	Shunts
—	1	PCB: MAX11613 EVALUATION KIT+

## MAX11614 EV Kit Daughter Board

DESIGNATION	QTY	DESCRIPTION
J2	1	16-pin dual-row (2 x 8) header
JU1–JU4	4	3-pin headers
JU5–JU13	9	2-pin headers
REF, SCL, SDA, 5V	4	White multipurpose test points
R1, R4, R7, R10, R13, R16, R19, R22	8	0 $\Omega$ $\pm$ 5% resistors (0603)
R35, R36	2	1k $\Omega$ $\pm$ 5% resistors (0603)
R37	1	2k $\Omega$ $\pm$ 5% resistor (0603)
R38, R39	2	470 $\Omega$ $\pm$ 5% resistors (0603)
U1	1	12-bit ADC (16 QSOP) Maxim MAX11614EEE+
U3	1	Voltage reference (8 SO) Maxim MAX6126AASA25+
—	13	Shunts
—	1	PCB: MAX11614 EVALUATION KIT+

# MAX11600–MAX11617 Evaluation System

**Evaluates: MAX11600–MAX11617**

## MAX11615 EV Kit Daughter Board

DESIGNATION	QTY	DESCRIPTION
AIN0–AIN7	8	Yellow multipurpose test points
AVDD_EXT	1	Red multipurpose test point
C1, C7	2	1 $\mu$ F $\pm$ 10%, 16V X5R ceramic capacitors (0603) Murata GRM188R61C105K
C2, C6	2	10 $\mu$ F $\pm$ 10%, 6.3V X5R ceramic capacitors (0603) Murata GRM188R60J106M
C5, C8, C9, C10	4	0.1 $\mu$ F $\pm$ 10%, 16V X7R ceramic capacitors (0603) TDK C1608X7R1C104K
C15, C20, C25, C30, C35, C40, C45, C50	0	Not installed, ceramic capacitors (0603)
D1	1	Red LED (0603)
D2	1	Yellow LED (0603)
GND	7	Black multipurpose test points
J1	1	2 x 10 right-angle female header

DESIGNATION	QTY	DESCRIPTION
J2	1	16-pin dual-row (2 x 8) header
JU1–JU4	4	3-pin headers
JU5–JU13	9	2-pin headers
REF, SCL, SDA, 3.6V	4	White multipurpose test points
R1, R4, R7, R10, R13, R16, R19, R22	8	0 $\Omega$ $\pm$ 5% resistors (0603)
R35, R36	2	1k $\Omega$ $\pm$ 5% resistors (0603)
R37	1	2k $\Omega$ $\pm$ 5% resistor (0603)
R38, R39	2	470 $\Omega$ $\pm$ 5% resistors (0603)
U1	1	12-bit ADC (16 QSOP) Maxim MAX11615EEE+
U3	1	Voltage reference (8 SO) Maxim MAX6126AASA25+
—	13	Shunts
—	1	PCB: MAX11615 EVALUATION KIT+

## MAX11616 EV Kit Daughter Board

DESIGNATION	QTY	DESCRIPTION
AIN0–AIN11	12	Yellow multipurpose test points
AVDD_EXT	1	Red multipurpose test point
C1, C7	2	1 $\mu$ F $\pm$ 10%, 16V X5R ceramic capacitors (0603) Murata GRM188R61C105K
C2, C6	2	10 $\mu$ F $\pm$ 10%, 6.3V X5R ceramic capacitors (0603) Murata GRM188R60J106M
C5, C8, C9, C10	4	0.1 $\mu$ F $\pm$ 10%, 16V X7R ceramic capacitors (0603) TDK C1608X7R1C104K
C15, C20, C25, C30, C35, C40, C45, C50, C55, C60, C65, C70	0	Not installed, ceramic capacitors (0603)
D1	1	Red LED (0603)
D2	1	Yellow LED (0603)
GND	7	Black multipurpose test points
J1	1	2 x 10 right-angle female header
J2	1	24-pin dual-row (2 x 12) header

DESIGNATION	QTY	DESCRIPTION
JU1, JU2, JU4	3	3-pin headers
JU5–JU17	13	2-pin headers
JU3	1	4-pin header
REF, SCL, SDA, +5V	4	White multipurpose test points
R1, R4, R7, R10, R13, R16, R19, R22, R25, R28, R31, R34	12	0 $\Omega$ $\pm$ 5% resistors (0603)
R35, R36	2	1k $\Omega$ $\pm$ 5% resistors (0603)
R37	1	2k $\Omega$ $\pm$ 5% resistor (0603)
R38, R39	2	470 $\Omega$ $\pm$ 5% resistors (0603)
U1	1	12-bit ADC (16 QSOP) Maxim MAX11616EEE+
U3	1	Voltage reference (8 SO) Maxim MAX6126AASA25+
—	17	Shunts
—	1	PCB: MAX11616 EVALUATION KIT+

# MAX11600-MAX11617 Evaluation System

## MAX11617 EV Kit Daughter Board

DESIGNATION	QTY	DESCRIPTION
AIN0-AIN11	12	Yellow multipurpose test points
AVDD_EXT	1	Red multipurpose test point
C1, C7	2	1 $\mu$ F $\pm$ 10%, 16V X5R ceramic capacitors (0603) Murata GRM188R61C105K
C2, C6	2	10 $\mu$ F $\pm$ 10%, 6.3V X5R ceramic capacitors (0603) Murata GRM188R60J106M
C5, C8, C9, C10	4	0.1 $\mu$ F $\pm$ 10%, 16V X7R ceramic capacitors (0603) TDK C1608X7R1C104K
C15, C20, C25, C30, C35, C40, C45, C50, C55, C60, C65, C70	0	Not installed, ceramic capacitors (0603)
D1	1	Red LED (0603)
D2	1	Yellow LED (0603)
GND	7	Black multipurpose test points
J1	1	2 x 10 right-angle female header
J2	1	24-pin dual-row (2 x 12) header

DESIGNATION	QTY	DESCRIPTION
JU1, JU2, JU4	3	3-pin headers
JU5-JU17	13	2-pin headers
JU3	1	4-pin header
REF, SCL, SDA, 3.6V	4	White multipurpose test points
R1, R4, R7, R10, R13, R16, R19, R22, R25, R28, R31, R34	12	0 $\Omega$ $\pm$ 5% resistors (0603)
R35, R36	2	1k $\Omega$ $\pm$ 5% resistors (0603)
R37	1	2k $\Omega$ $\pm$ 5% resistor (0603)
R38, R39	2	470 $\Omega$ $\pm$ 5% resistors (0603)
U1	1	12-bit ADC (16 QSOP) Maxim MAX11617EEE+
U3	1	Voltage reference (8 SO) Maxim MAX6126AASA25+
—	17	Shunts
—	1	PCB: MAX11617 EVALUATION KIT+

## Component Suppliers

SUPPLIER	PHONE	WEBSITE
Hong Kong X'tals Ltd	852-35112388	www.hongkongcrystal.com
Murata Electronics North America, Inc.	770-436-1300	www.murata-northamerica.com
Taiyo Yuden	800-348-2496	www.t-yuden.com
TDK Corp.	847-803-6100	www.component.tdk.com

**Note:** Indicate you are using the MAX11600-MAX11617 when contacting these component suppliers.

## MAX11600-MAX11617 EV System Files

FILE	DESCRIPTION
INSTALL.EXE	Installs the EV system files on your computer
MAX11600-11617.EXE	Application program
FTD2XX.INF	USB device driver file
UNINST.INI	Uninstalls the EV system software
USB_Driver_Help.PDF	USB driver installation help file

# MAX11600–MAX11617 Evaluation System

## Quick Start

### Required Equipment

- MAX116XX I2C master board (USB cable included)
- One of the EV kit daughter boards
- +5.5V, 0.5A power supply
- Function generator
- Windows 2000, Windows XP, or Windows Vista (32-bit) PC with a spare USB port

**Note:** In the following sections, software-related items are identified by bolding. Text in **bold** refers to items directly from the EV system software. Text in **bold and underlined** refers to items from the Windows operating system.

### Procedure

The MAX11600–MAX11617 EV system is fully assembled and tested. Follow the steps below to verify board operation. **Caution: Do not turn on the power supply until all connections are completed.**

- 1) Visit [www.maxim-ic.com/evkitsoftware](http://www.maxim-ic.com/evkitsoftware) to download the latest version of the EV system software, 11600-11617Rxx.ZIP. Save the EV system software to a temporary folder and uncompress the ZIP file.
- 2) Install the EV system software on your computer by running the INSTALL.EXE program inside the temporary folder. The program files are copied and icons are created in the Windows **Start | Programs** menu.
- 3) Carefully connect the boards by aligning the EV kit daughter board's 20-pin connector with the 20-pin header of the MAX116XX I2C master board. Gently press them together.
- 4) Verify that all jumpers are in their default positions for the master board (Table 1) and the appropriate jumper table for the selected EV kit daughter board (Tables 2, 3, and 4).
- 5) Connect the positive terminal of the +5.5V power supply to the DVDD banana connector on the master board. Connect the negative terminal of the same power supply to the DGND banana connector on the master board.
- 6) Connect the positive terminal of the signal generator to the AIN0 connector on the EV kit daughter board. Connect the negative terminal of the signal generator to the GND connector on the EV kit daughter board.
- 7) Turn on the +5.5V power supply.
- 8) Set the signal source to generate a 1kHz, 1V<sub>P-P</sub> sinusoidal wave with +2V offset.
- 9) Connect the USB cable from the PC to the master board. A **New Hardware Found** window pops up when installing the USB driver for the first time. If a window is not seen that is similar to the one described above after 30s, remove the USB cable from the board and reconnect it. Administrator privileges are required to install the USB device driver on Windows.
- 10) Follow the directions of the **Found New Hardware** window to install the USB device driver. Manually specify the location of the device driver to be **C:\Program Files\MAX11600-MAX11617** (default installation directory) using the **Browse** button. During device driver installation, Windows may show a warning message indicating that the device driver Maxim uses does not contain a digital signature. This is not an error condition and it is safe to proceed with installation. Refer to the USB\_Driver\_Help.PDF document included with the software for additional information.
- 11) Start the MAX11600–MAX11617 EV system software by opening its icon in the **Start | Programs** menu. The EV system software device-selection window appears, as shown in Figure 1. Select the appropriate device from the **Select the ADC device** drop-down list. The EV system software main window appears, as shown in Figure 2.
- 12) Select **1024** from the **Number of Samples** drop-down list in the **Data Logging** group box.
- 13) Enter **94.44** into the **Sample Rate (ksps)** edit box to set the maximum sampling rate.
- 14) Check the **Remove DC** checkbox to remove the DC component of the sampled data.
- 15) Press the **Start Conversion** button.
- 16) Verify **Frequency** of approximately 1.00kHz, **RMS** value of 0.353V, **MIN** value of -0.50V, **MAX** value of +0.50V, and **Avg DC** value of 0V are displayed in the **Calculation** group box.



# MAX11600-MAX11617 Evaluation System

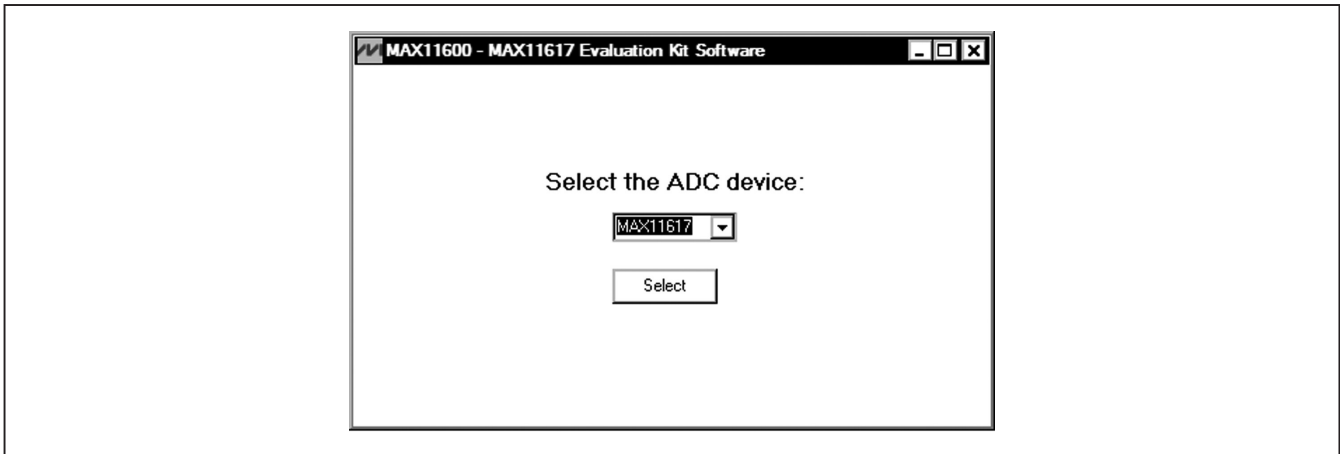

Figure 1. MAX11600-MAX11617 EV System Software Device Selection Window

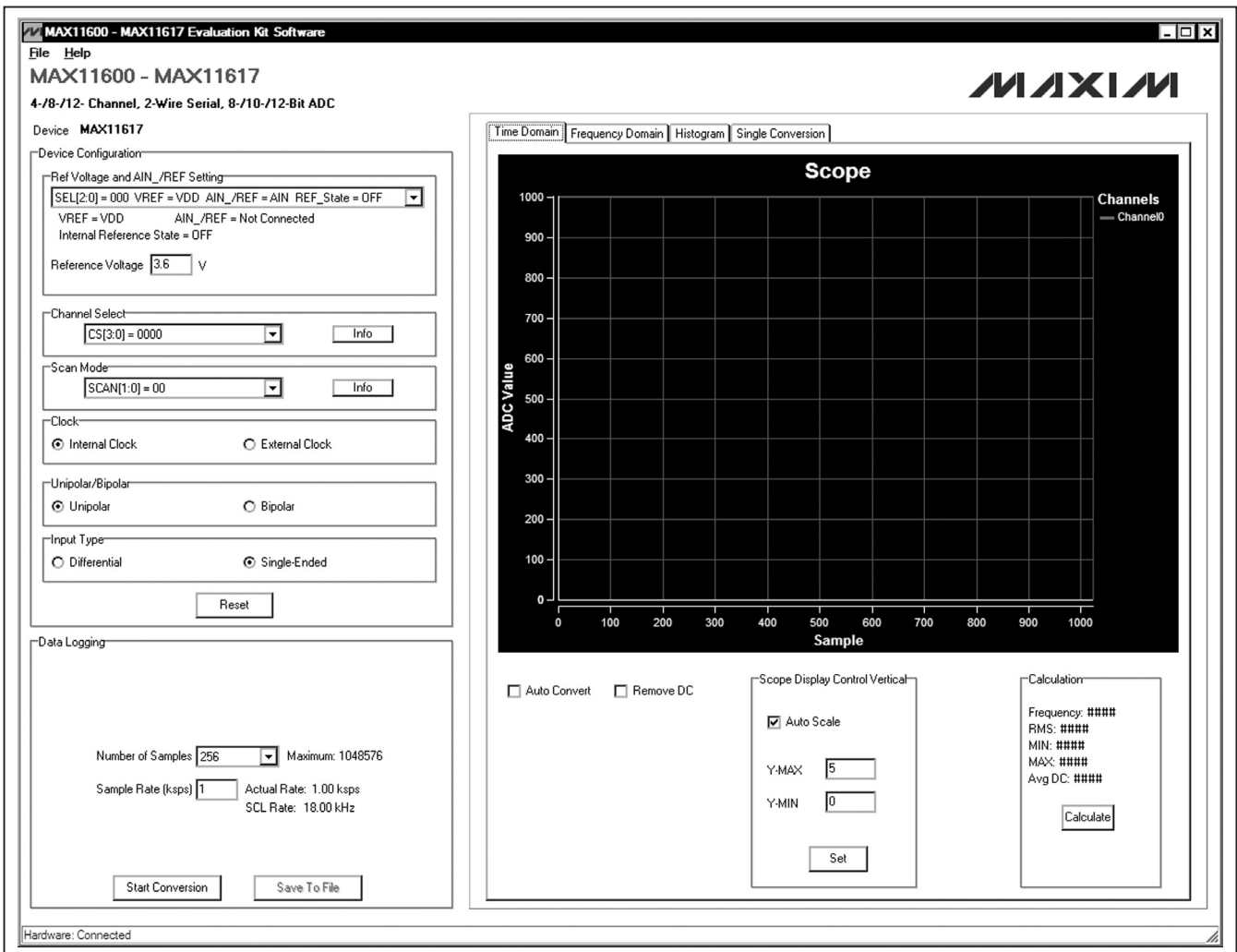

Figure 2. MAX11600-MAX11617 EV System Software Main Window

# MAX11600–MAX11617 Evaluation System

Evaluates: MAX11600–MAX11617

## Detailed Description of Software

The MAX11600–MAX11617 EV system software supports all the MAX11600–MAX11617 ADC devices. When the EV system software starts up, select the appropriate device from the **Select the ADC device** drop-down list shown in Figure 1. Press the **Select** button to bring up the main software window.

The main window of the evaluation software (Figure 2) contains a **Device Configuration** group box, a **Data Logging** group box, and four tab sheets to display the sampled data.

### Device Configuration

The **Device Configuration** group box is used to configure the selected ADC device.

Use the drop-down list in the **Ref Voltage and AIN\_/REF Setting** group box to select the source of the voltage reference and configure the properties of the AIN\_/REF pin of the ADC device. If the source of the voltage reference is set to VDD or external reference, enter the actual voltage value in the **Reference Voltage** edit box. This value is used to calculate the voltage from the ADC code.

The drop-down list in the **Channel Select** group box configures the ADC's channel-selection register that determines the analog input channels to be used for conversion. Press the **Info** button to bring up a channel-selection table for reference (Figure 3).

In the **Scan Mode** group box, use the drop-down list to select one of the four scan modes. Press the **Info** button to bring up a scanning configuration table for reference (Figure 4).

Channel Selection in Single-Ended Mode (SGL/DIF = 1)																
CS3 <sup>1</sup>	CS2 <sup>1</sup>	CS1	CS0	AIN0	AIN1	AIN2	AIN3 <sup>2</sup>	AIN4	AIN5	AIN6	AIN7	AIN8	AIN9	AIN10	AIN11 <sup>2</sup>	GND
0	0	0	0	+												-
0	0	0	1		+											-
0	0	1	0			+										-
0	0	1	1				+									-
0	1	0	0					+								-
0	1	0	1						+							-
0	1	1	0							+						-
0	1	1	1								+					-
1	0	0	0									+				-
1	0	0	1										+			-
1	0	1	0											+		-
1	0	1	1												+	-
1	1	0	0	RESERVED												
1	1	0	1	RESERVED												
1	1	1	0	RESERVED												
1	1	1	1	RESERVED												

<sup>1</sup>For the MAX11612/MAX11613, CS3 and CS2 are internally set to 0. For the MAX11614/MAX11615, CS3 is internally set to 0.

<sup>2</sup>When SEL1 = 1, a single-ended read of AIN3/REF (MAX11612/MAX11613) or AIN11/REF (MAX11616/MAX11617) is ignored; scan stops at AIN2 or AIN10. This does not apply to the MAX11614/MAX11615 as each provides separate pins for AIN7 and REF.

Figure 3. Channel-Selection Reference Table

# MAX11600-MAX11617 Evaluation System

Scan Mode Help		
Scanning Configuration		
SCAN1	SCAN0	SCANNING CONFIGURATION
0	0	Scans up from AIN0 to the input selected by CS3-CS0. When CS3-CS0 exceeds 1011, the scanning stops at AIN11. When AIN_/REF is set to be a REF input/output, scanning stops at AIN2 or AIN10.
0	1	*Converts the input selected by CS3-CS0 eight times (see Tables 3 and 4).
1	0	<b>MAX11612/MAX11613: Scans upper half of channels.</b> Scans up from AIN2 to the input selected by CS1 and CS0. When CS1 and CS0 are set for AIN0, AIN1, and AIN2, the only scan that takes place is AIN2 (MAX11612/MAX11613). When AIN/REF is set to be a REF input/output, scanning stops at AIN2.
		<b>MAX11614/MAX11615: Scans upper quartile of channels.</b> Scans up from AIN6 to the input selected by CS3-CS0. When CS3-CS0 is set for AIN0-AIN6, the only scan that takes place is AIN6 (MAX11614/MAX11615).
		<b>MAX11616/MAX11617: Scans upper half of channels.</b> Scans up from AIN6 to the input selected by CS3-CS0. When CS3-CS0 is set for AIN0-AIN6, the only scan that takes place is AIN6 (MAX11616/MAX11617). When AIN/REF is set to be a REF input/output, scanning stops at selected channel or AIN10.
1	1	*Converts channel selected by CS3-CS0.

*\*When operating in external clock mode, there is no difference between SCAN[1:0] = 01 and SCAN[1:0] = 11, and converting occurs perpetually until not-acknowledge occurs.*

Figure 4. Scanning Configuration Reference Table

The user can set the **clock** mode (internal or external) in the **Clock** group box, select unipolar or bipolar mode in the **Unipolar/Bipolar** group box, or choose the analog input type (differential or single ended) in the **Input Type** group box.

Press the **Reset** button to reset the ADC registers to their default settings.

### Data Logging

In the **Data Logging** group box, the user can select the desired number of conversions in the **Number of Samples** drop-down list. Enter the desired sampling rate in the **Sample Rate (ksps)** edit box. The actual sampling rate and the I<sup>2</sup>C SCL rate are displayed at the right of the **Sample Rate (ksps)** edit box. Press the **Start Conversion** button to start sampling. After sampling is finished, the user can save the data to a file by pressing the **Save To File** button. The **Save To File** button is not active until the sampling is done.

### Time Domain, Frequency Domain, Histogram, and Single Conversion Tabs

After the **Start Conversion** button in the **Data Logging** group box is pressed, the sampled data in the time

domain is plotted in the **Time Domain** tab sheet. The sampled data in the frequency domain is plotted in the **Frequency Domain** tab sheet. The histogram of the sampled signal is plotted in the **Histogram** tab sheet. The **Single Conversion** tab sheet displays one set of sampled data in any scan mode.

Check the **Auto Convert** checkbox to automatically and repeatedly do the ADC conversions and update the active tab sheet.

### Time Domain Tab

In the **Time Domain** tab sheet (Figure 5), check the **Remove DC** checkbox to remove the DC component of the sampled signal. In the **Scope Display Control Vertical** group box, when the **Auto Scale** checkbox is checked, the software automatically scales the vertical axis in the plot. If the **Auto Scale** checkbox is unchecked, enter the appropriate values into the **Y-MAX** and **Y-MIN** edit boxes and press the **Set** button to set the boundaries for the vertical axis. The software automatically calculates the **Frequency**, **RMS**, **MIN**, **MAX**, and **Avg DC** of the sampled signal, and displays the calculated values in the **Calculation** group box.

# MAX11600-MAX11617 Evaluation System

Evaluates: MAX11600-MAX11617

## Frequency Domain Tab

The **Frequency Domain** tab sheet (Figure 6) displays the FFT plot of the signal shown in the **Time Domain** tab sheet.

## Histogram Tab

The **Histogram** tab sheet (Figure 7) displays the histogram of the signal shown in the **Time Domain** tab sheet. The software automatically calculates the **Mean** and the **Std Dev** (standard deviation, sigma), and displays the calculated values in the **Calculation** group box.

The **Histogram Display Control** group box provides three options to scale the horizontal axis on the histo-

gram. These options include **(Mean - 3 sigma) to (Mean + 3 sigma)**, **(Mean - 6 sigma) to (Mean + 6 sigma)**, and the **User Define** range.

## Single Conversion

The **ADC Value Display for Single Conversion** group box in the **Single Conversion** tab sheet (Figure 8) displays the **ADC Codes** and the calculated **Voltage** values for a single sample of all the channels that associate with the selected scan mode. Pressing the **Start Conversion** button in the **Data Logging** group box shown in Figure 2 updates the status of the **ADC Value Display for Single Conversion** group box.

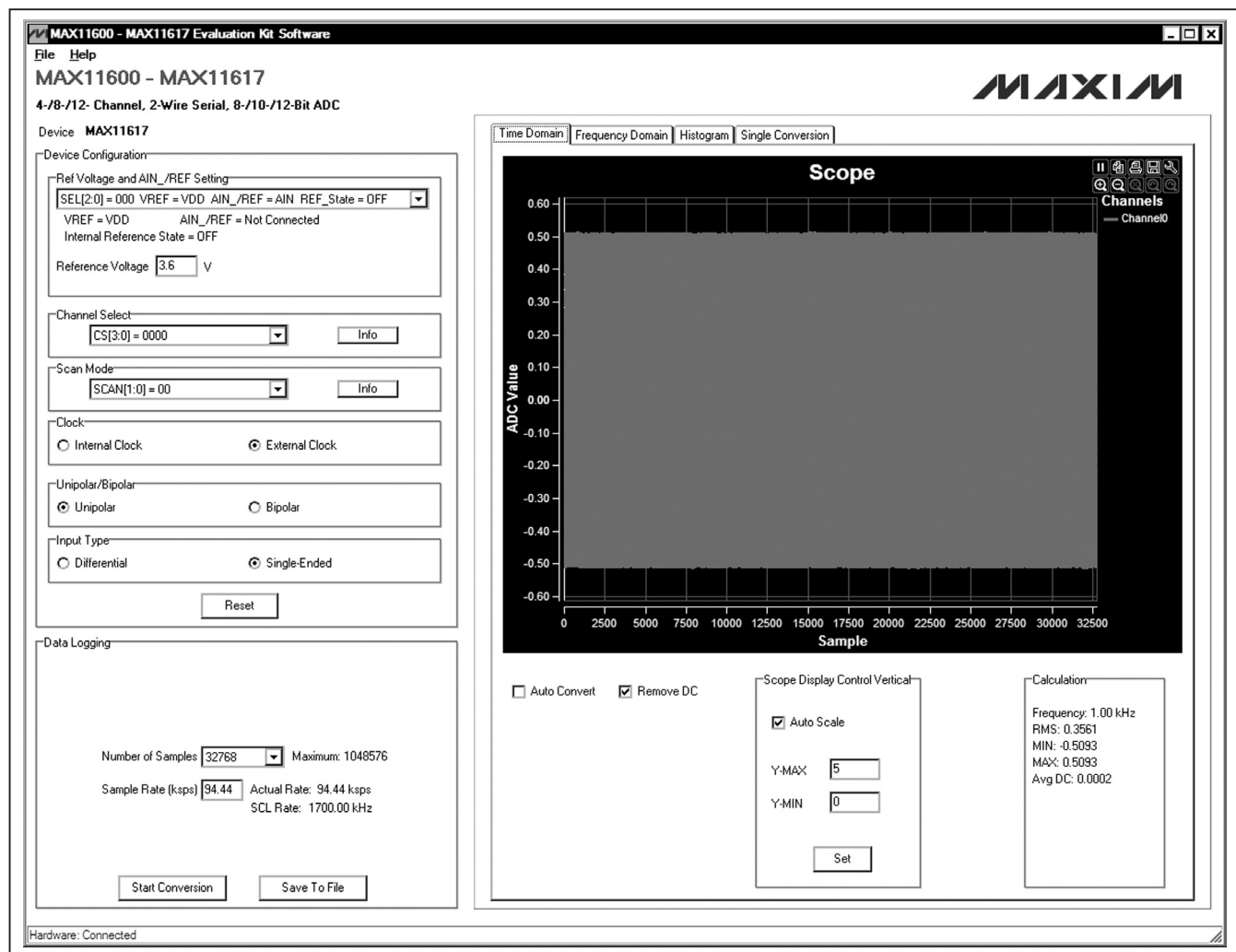

Figure 5. Time Domain Tab

# MAX11600-MAX11617 Evaluation System

Evaluates: MAX11600-MAX11617

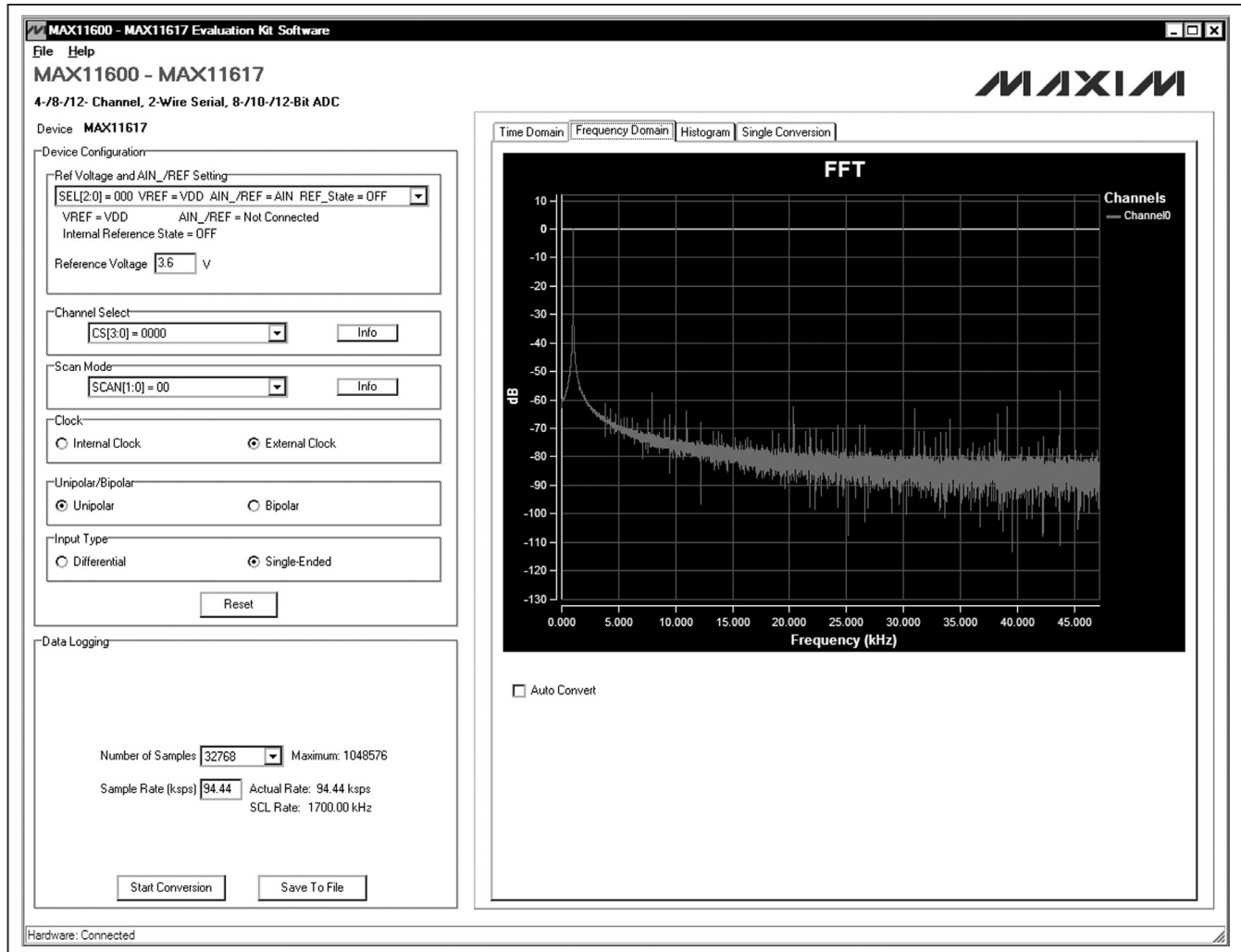

Figure 6. Frequency Domain Tab

# MAX11600-MAX11617 Evaluation System

Evaluates: MAX11600-MAX11617

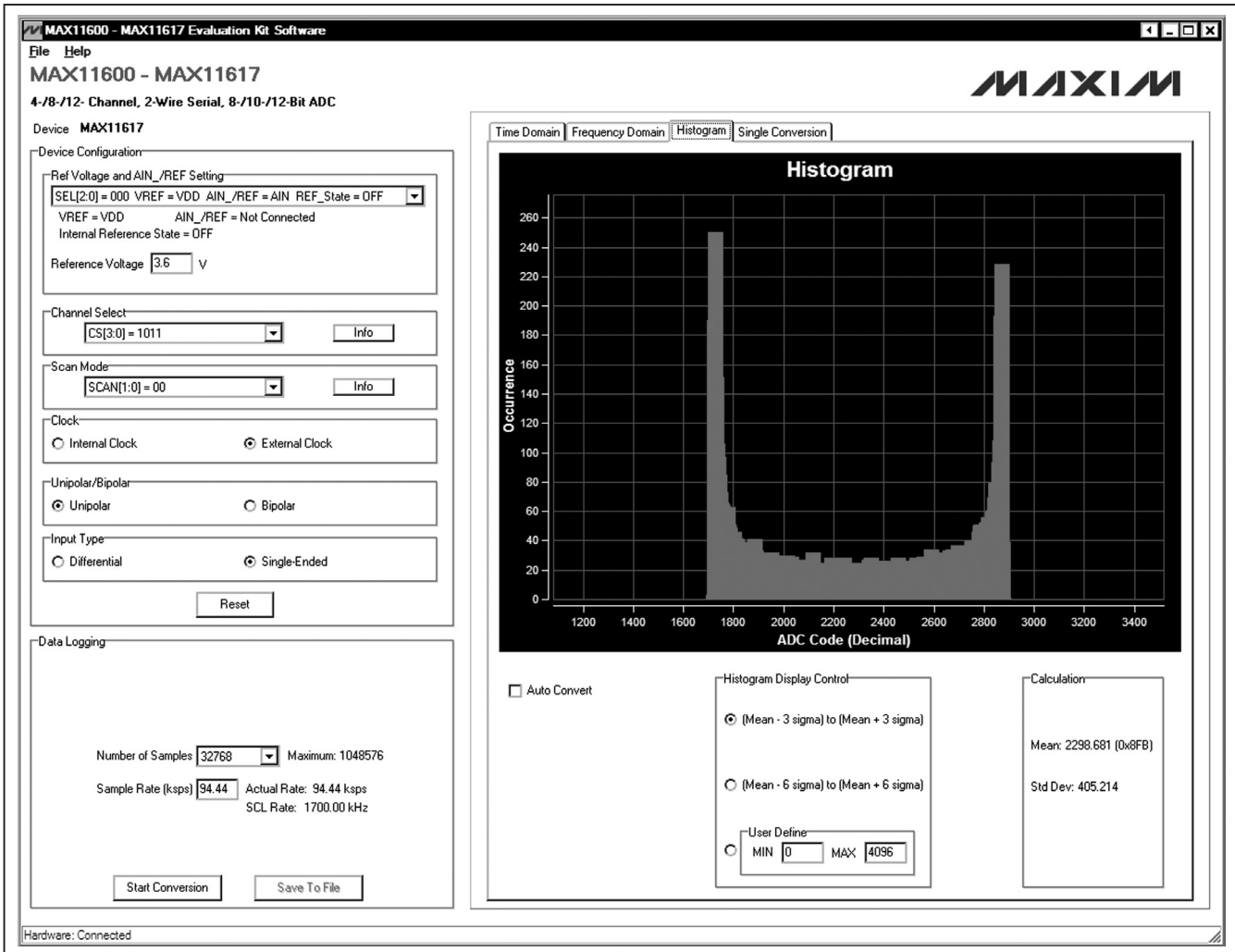

Figure 7. Histogram Tab

# MAX11600-MAX11617 Evaluation System

Evaluates: MAX11600-MAX11617

The screenshot displays the 'MAX11600 - MAX11617 Evaluation System Software' window. The title bar includes 'File' and 'Help' menus. The main window title is 'MAX11600 - MAX11617' with the subtitle '4-/8-/12- Channel, 2-Wire Serial, 8-/10-/12-Bit ADC'. The device is identified as 'MAX11617'.

**Device Configuration:**

- Ref Voltage and AIN\_/REF Setting:** A dropdown menu shows 'SEL[2:0] = 000 VREF = VDD AIN\_/REF = AIN REF\_State = OFF'. Below it, 'VREF = VDD AIN\_/REF = Analog Input' and 'Internal Reference State = OFF' are displayed. A 'Reference Voltage' field is set to '3.6 V'.
- Channel Select:** A dropdown menu shows 'CS[3:0] = 0000' with an 'Info' button.
- Scan Mode:** A dropdown menu shows 'SCAN[1:0] = 00' with an 'Info' button.
- Clock:** Radio buttons for 'Internal Clock' and 'External Clock' (selected).
- Unipolar/Bipolar:** Radio buttons for 'Unipolar' (selected) and 'Bipolar'.
- Input Type:** Radio buttons for 'Differential' and 'Single-Ended' (selected).
- A 'Reset' button is located at the bottom of this section.

**Data Logging:**

- 'Number of Samples' is set to '32768' (Maximum: 1048576).
- 'Sample Rate (kpsps)' is set to '94.44' (Actual Rate: 94.44 kpsps, SCL Rate: 1700.00 kHz).
- 'Start Conversion' and 'Save To File' buttons are at the bottom.

**ADC Value Display for Single Conversion:**

The 'Single Conversion' tab is active, showing a table of ADC results for 12 channels:

Channel	Code	Voltage
Channel 0	Code: 0x6BF	Voltage: 1.5179
Channel 1	Code: 0x####	Voltage: #.####
Channel 2	Code: 0x####	Voltage: #.####
Channel 3	Code: 0x####	Voltage: #.####
Channel 4	Code: 0x####	Voltage: #.####
Channel 5	Code: 0x####	Voltage: #.####
Channel 6	Code: 0x####	Voltage: #.####
Channel 7	Code: 0x####	Voltage: #.####
Channel 8	Code: 0x####	Voltage: #.####
Channel 9	Code: 0x####	Voltage: #.####
Channel 10	Code: 0x####	Voltage: #.####
Channel 11	Code: 0x####	Voltage: #.####

An 'Auto Convert' checkbox is located below the table. The status bar at the bottom left indicates 'Hardware: Connected'.

Figure 8. Single Conversion Tab

# MAX11600-MAX11617 Evaluation System

## Detailed Description of Hardware

### **MAX11600-MAX11617 EV System**

The MAX11600-MAX11617 EV system is a complete data-acquisition system that consists of one master board and one of the six companion EV kit daughter boards.

### **MAX116XX I2C Master Board**

The MAX116XX I2C master board connects to a PC USB port and allows the transfer of I2C commands to the EV kit daughter board.

### **Power Supply**

One +5.5V power supply is required to power up the MAX116XX I2C master board. Connect the positive terminal of the power supply to the DVDD connector and the negative terminal to the DGND connector on the master board.

### **EV Kit Daughter Boards**

The EV kit daughter boards are fully assembled and tested PCBs that demonstrate the capabilities of the MAX11600-MAX11617 4-/8-/12-channel, 8-/10-/12-bit, 3V/5V, low-power, high-speed I2C ADCs with internal reference.

Each EV kit daughter board evaluates three different ADCs. See the *Ordering Information/Selector Guide*

section to select the desired EV kit daughter board and ADC.

Carefully connect the EV kit daughter board to the master board by aligning the EV kit daughter board's 20-pin connector (J1) with the 20-pin header (J1) of the master board. Gently press them together.

### **Voltage Reference**

An on-board +2.5V voltage reference (U3) is provided on the EV kit daughter board. To use a user-supplied reference voltage, see the applicable EV kit daughter board's jumper table to place the shunt of jumper JU3 to the appropriate position and connect the external reference voltage to the REF connector.

### **Power Supply**

By default, the EV kit daughter board is powered from the master board. To use an external power supply, move the shunt of jumper JU4 to the 2-3 position. Apply a user-supplied power supply at the AVDD\_EXT connector.

### **User-Supplied I2C Interface**

To use the EV kit daughter board with a user-supplied I2C interface, first move the shunts of jumpers JU1 and JU2 to the 2-3 position and connect the user-supplied SCL and SDA signals to the corresponding SCL and SDA connectors on the EV kit daughter board.

**Table 1. Master Board Jumper Settings (JU6–JU9)**

JUMPER	SHUNT POSITION	DESCRIPTION
JU6	1-2*	On-board LDO (U6) provides +3.6V output to the EV system
	Open	Disconnects the output of the on-board LDO (U6)
JU7	1-2*	On-board LDO (U7) provides +2.5V output to the EV system
	Open	Disconnects the output of the on-board LDO (U7)
JU8	1-2*	On-board LDO (U10) provides +5V output to the EV system
	2-3	Disconnects the output of the on-board LDO (U10)
JU9	1-2*	The on-board LDO (U11) provides +1.2V output to the EV system
	Open	Disconnects the output of the on-board LDO (U11)

\*Default position.



## MAX11600–MAX11617 Evaluation System

**Table 2. MAX11612/MAX11613 EV Kit Daughter Board Jumper Table (JU1–JU9)**

JUMPER	SHUNT POSITION	DESCRIPTION
JU1	1-2*	Connects the SDA signal of U1 to the controller on the master board
	2-3	Connects the SDA signal of U1 to the SDA connector
JU2	1-2	Connects the SCL signal of U1 to the controller on the master board
	2-3*	Connects the SCL signal of U1 to the SCL connector
JU3	1-2*	Connects the AIN3/REF pin of U1 to the AIN3 connector
	1-3	Connects the output of the on-board voltage reference to the AIN3/REF pin of U1
	1-4	Connects the AIN3/REF pin of U1 to the REF connector
JU4	1-2*	Powers U1 from the master board
	1-3	Connects the VDD pin of U1 to the AVDD_EXT connector
JU5	1-2	Connects the AIN0 connector to GND
	Open*	Disconnects AIN0 from GND
JU6	1-2	Connects the AIN1 connector to GND
	Open*	Disconnects AIN1 from GND
JU7	1-2	Connects the AIN2 connector to GND
	Open*	Disconnects AIN2 from GND
JU8	1-2	Connects the AIN3 connector to GND
	Open*	Disconnects AIN3 from GND
JU9	1-2	Connects R37 between JU3 and the AIN3/REF pin of U1
	Open*	Bypasses R37 between JU3 and the AIN3/REF pin of U1

\*Default position.

**Table 3. MAX11614/MAX11615 EV Kit Daughter Board Jumper Table (JU1–JU13)**

JUMPER	SHUNT POSITION	DESCRIPTION
JU1	1-2*	Connects the SDA signal of U1 to the controller on the master board
	2-3	Connects the SDA signal of U1 to the SDA connector
JU2	1-2*	Connects the SCL signal of U1 to the controller on the master board
	2-3	Connects the SCL signal of U1 to the SCL connector
JU3	1-2*	Connects the output of the on-board voltage reference to the REF pin of U1
	1-3	Connects the REF pin of U1 to the REF connector
JU4	1-2*	Powers U1 from the master board
	1-3	Connects the VDD pin of U1 to the AVDD_EXT connector
JU5	1-2	Connects the AIN0 connector to GND
	Open*	Disconnects AIN0 from GND
JU6	1-2	Connects the AIN1 connector to GND
	Open*	Disconnects AIN1 from GND
JU7	1-2	Connects the AIN2 connector to GND
	Open*	Disconnects AIN2 from GND
JU8	1-2	Connects the AIN3 connector to GND
	Open*	Disconnects AIN3 from GND
JU9	1-2	Connects the AIN4 connector to GND
	Open*	Disconnects AIN4 from GND
JU10	1-2	Connects the AIN5 connector to GND
	Open*	Disconnects AIN5 from GND

# MAX11600–MAX11617 Evaluation System

**Evaluates: MAX11600–MAX11617**

**Table 3. MAX11614/MAX11615 EV Kit Daughter Board Jumper Table (JU1–JU13) (continued)**

JUMPER	SHUNT POSITION	DESCRIPTION
JU11	1-2	Connects the AIN6 connector to GND
	Open*	Disconnects AIN6 from GND
JU12	1-2	Connects the AIN7 connector to GND
	Open*	Disconnects AIN7 from GND
JU13	1-2	Connects R37 between JU3 and the REF pin of U1
	Open*	Bypasses R37 between JU3 and the REF pin of U1

\*Default position.

**Table 4. MAX11616/MAX11617 EV Kit Daughter Board Jumper Table (JU1–JU17)**

JUMPER	SHUNT POSITION	DESCRIPTION
JU1	1-2*	Connects the SDA signal of U1 to the controller on the master board
	2-3	Connects the SDA signal of U1 to the SDA connector
JU2	1-2*	Connects the SCL signal of U1 to the controller on the master board
	2-3	Connects the SCL signal of U1 to the SCL connector
JU3	1-2*	Connects the AIN11/REF pin of U1 to the AIN11 connector
	1-3	Connects the output of the on-board voltage reference to the AIN11/REF pin of U1
	1-4	Connects the AIN11/REF pin of U1 to the REF connector
JU4	1-2*	Powers U1 from the master board
	1-3	Connects the VDD pin of U1 to the AVDD_EXT connector
JU5	1-2	Connects the AIN0 connector to GND
	Open*	Disconnects AIN0 from GND
JU6	1-2	Connects the AIN1 connector to GND
	Open*	Disconnects AIN1 from GND
JU7	1-2	Connects the AIN2 connector to GND
	Open*	Disconnects AIN2 from GND
JU8	1-2	Connects the AIN3 connector to GND
	Open*	Disconnects AIN3 from GND
JU9	1-2	Connects the AIN4 connector to GND
	Open*	Disconnects AIN4 from GND
JU10	1-2	Connects the AIN5 connector to GND
	Open*	Disconnects AIN5 from GND
JU11	1-2	Connects the AIN6 connector to GND
	Open*	Disconnects AIN6 from GND
JU12	1-2	Connects the AIN7 connector to GND
	Open*	Disconnects AIN7 from GND
JU13	1-2	Connects the AIN8 connector to GND
	Open*	Disconnects AIN8 from GND
JU14	1-2	Connects the AIN9 connector to GND
	Open*	Disconnects AIN9 from GND
JU15	1-2	Connects the AIN10 connector to GND
	Open*	Disconnects AIN10 from GND
JU16	1-2	Connects the AIN11 connector to GND
	Open*	Disconnects AIN11 from GND
JU17	1-2	Connects R37 between JU3 and the AIN11/REF pin of U1
	Open*	Bypasses R37 between JU3 and the AIN11/REF pin of U1

\*Default position.

# MAX11600-MAX11617 Evaluation System

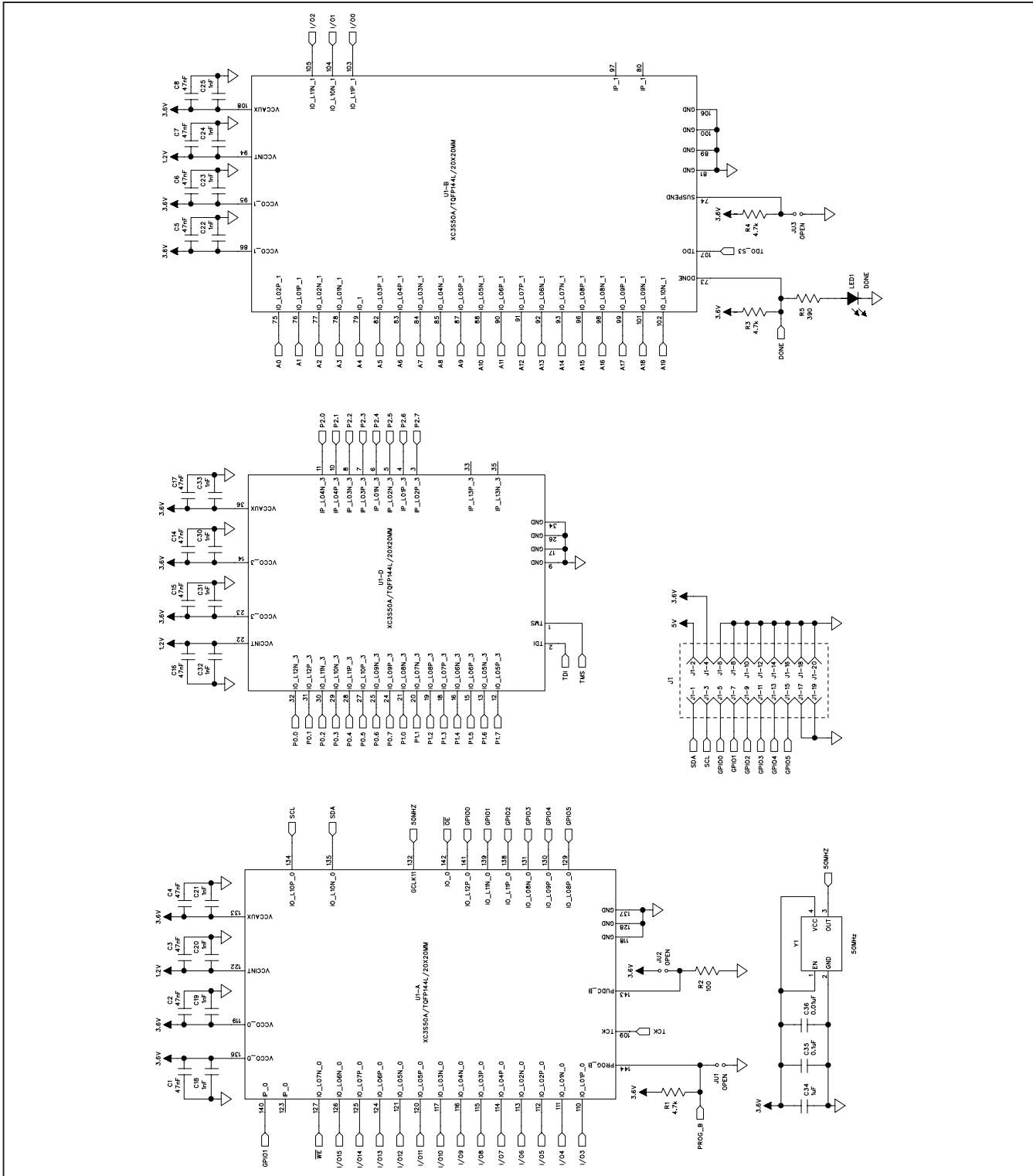

Figure 9a. MAX116XX I2C Master Board Schematic (Sheet 1 of 4)

# MAX11600-MAX11617 Evaluation System

Evaluates: MAX11600-MAX11617

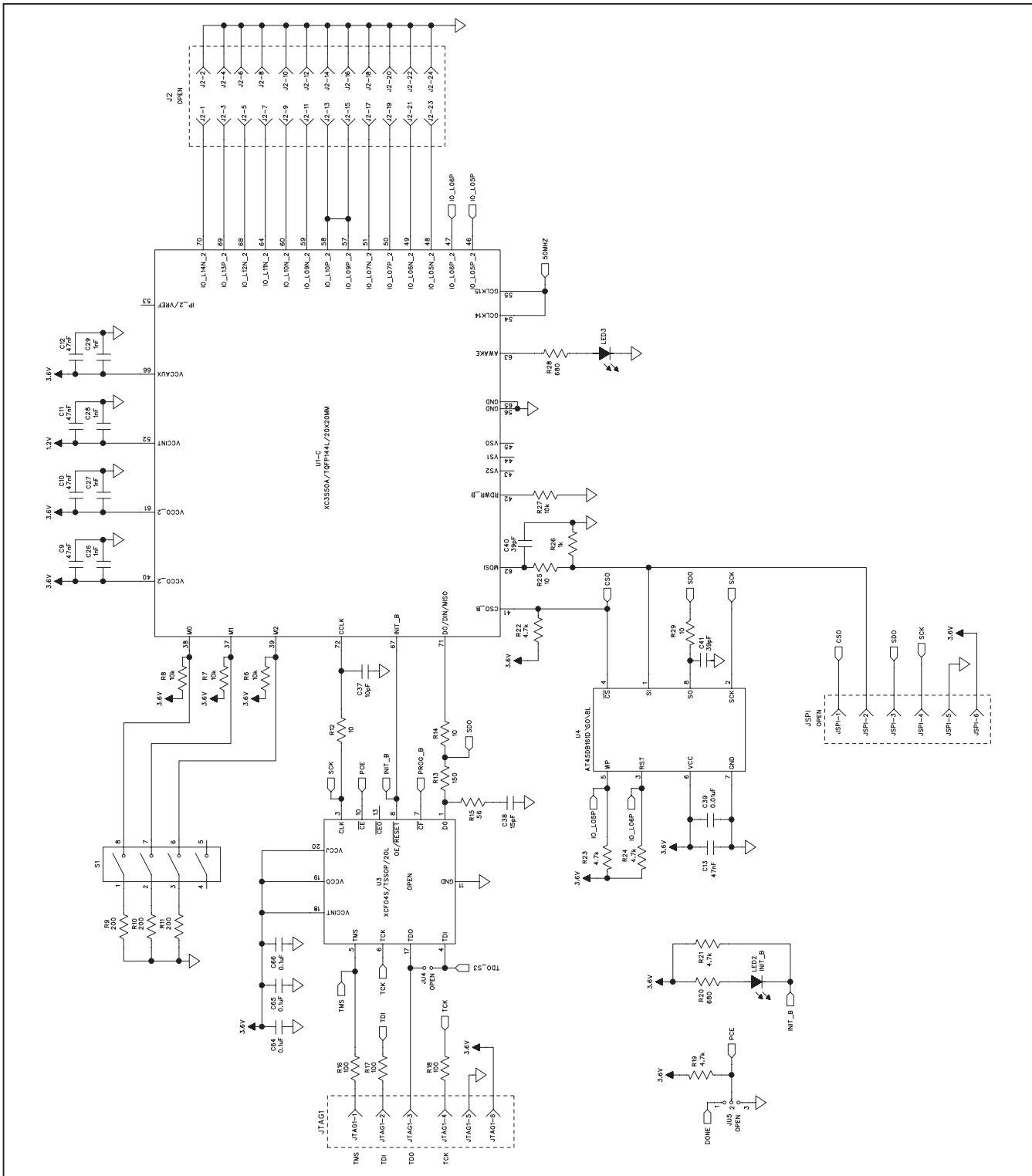

Figure 9b. MAX116XX I2C Master Board Schematic (Sheet 2 of 4)

# MAX11600-MAX11617 Evaluation System

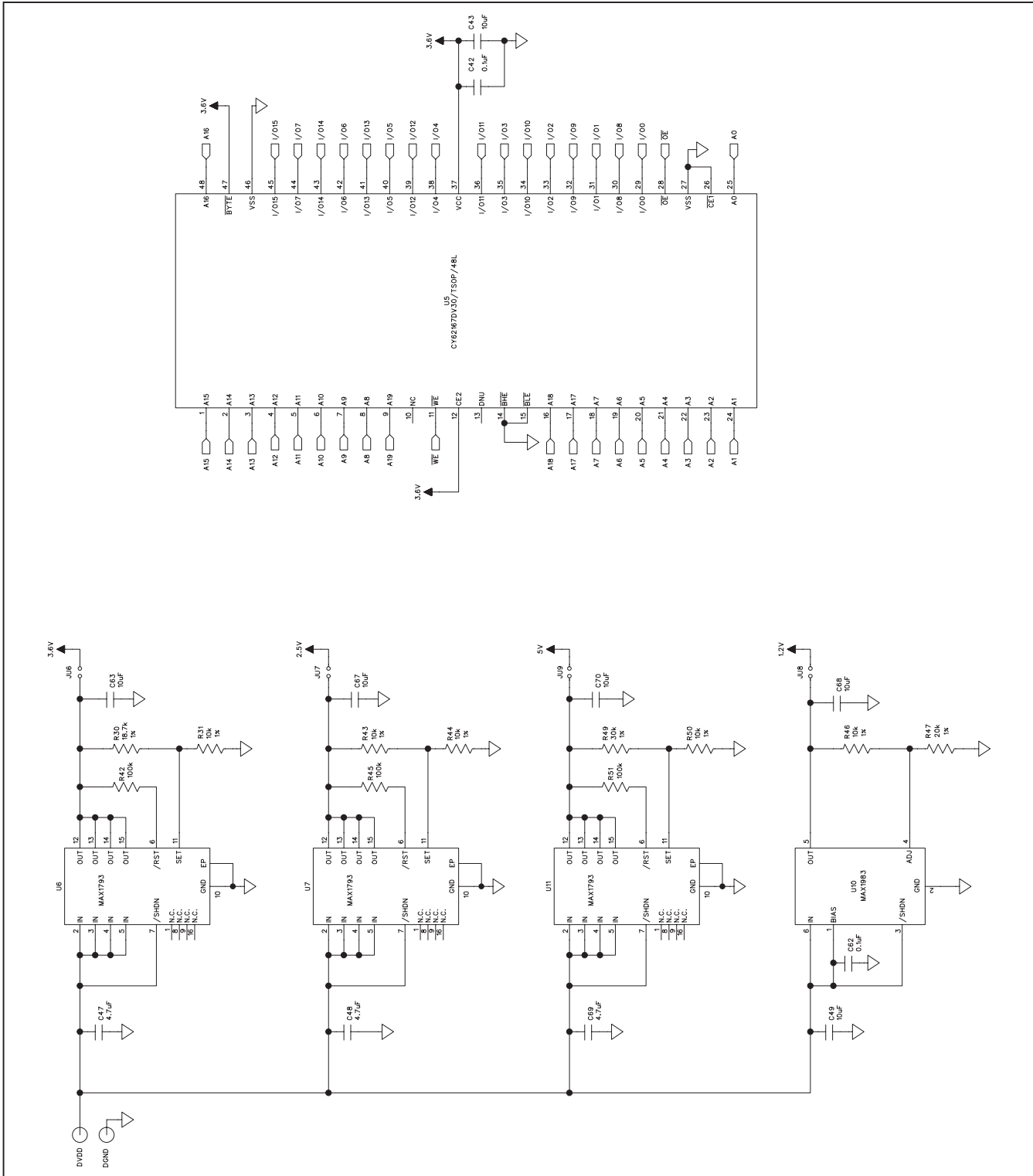

Figure 9c. MAX116XX I2C Master Board Schematic (Sheet 3 of 4)

# MAX11600-MAX11617 Evaluation System

Evaluates: MAX11600-MAX11617

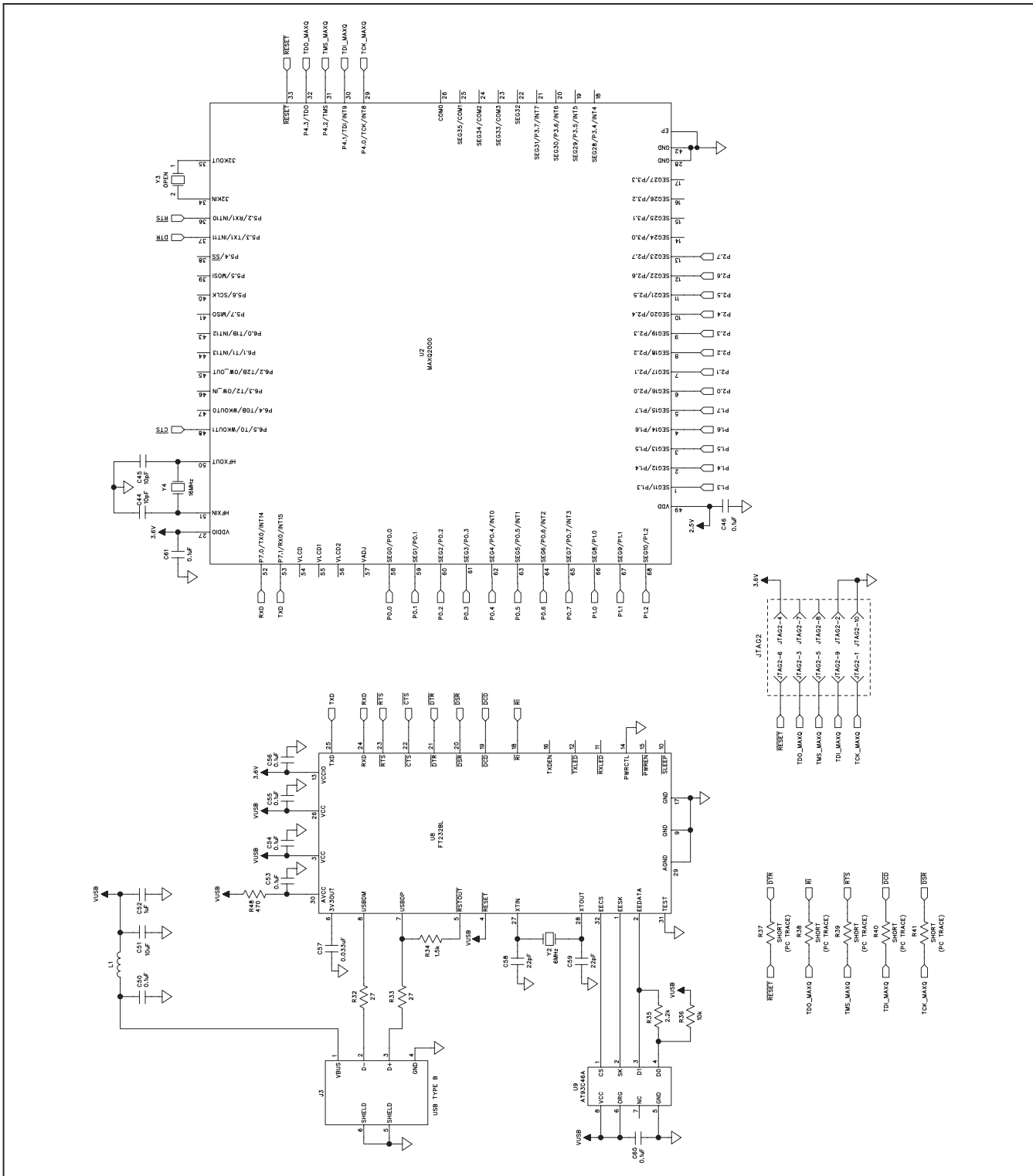

Figure 9d. MAX116XX I2C Master Board Schematic (Sheet 4 of 4)



# MAX11600-MAX11617 Evaluation System

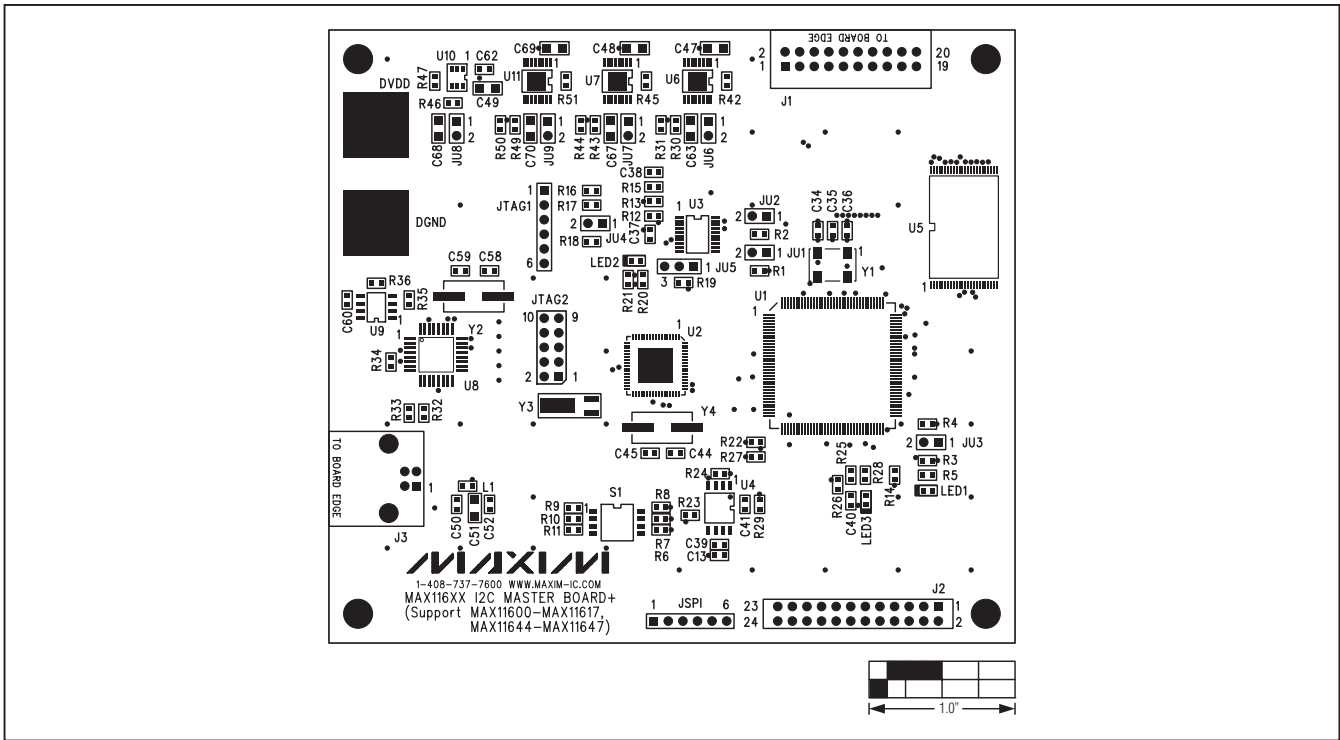

Figure 10. MAX116XX I2C Master Board Component Placement Guide—Top

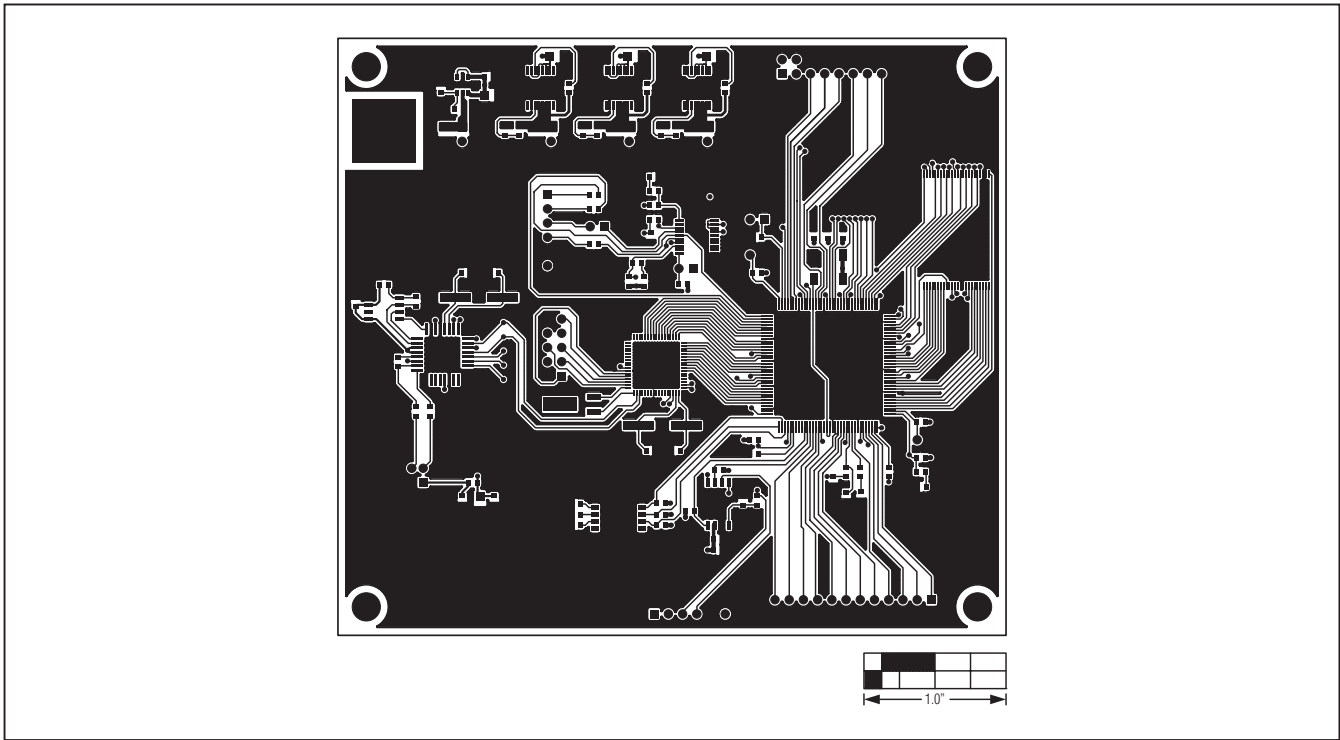

Figure 11. MAX116XX I2C Master Board PCB Layout—Component Side

# MAX11600–MAX11617 Evaluation System

Evaluates: MAX11600–MAX11617

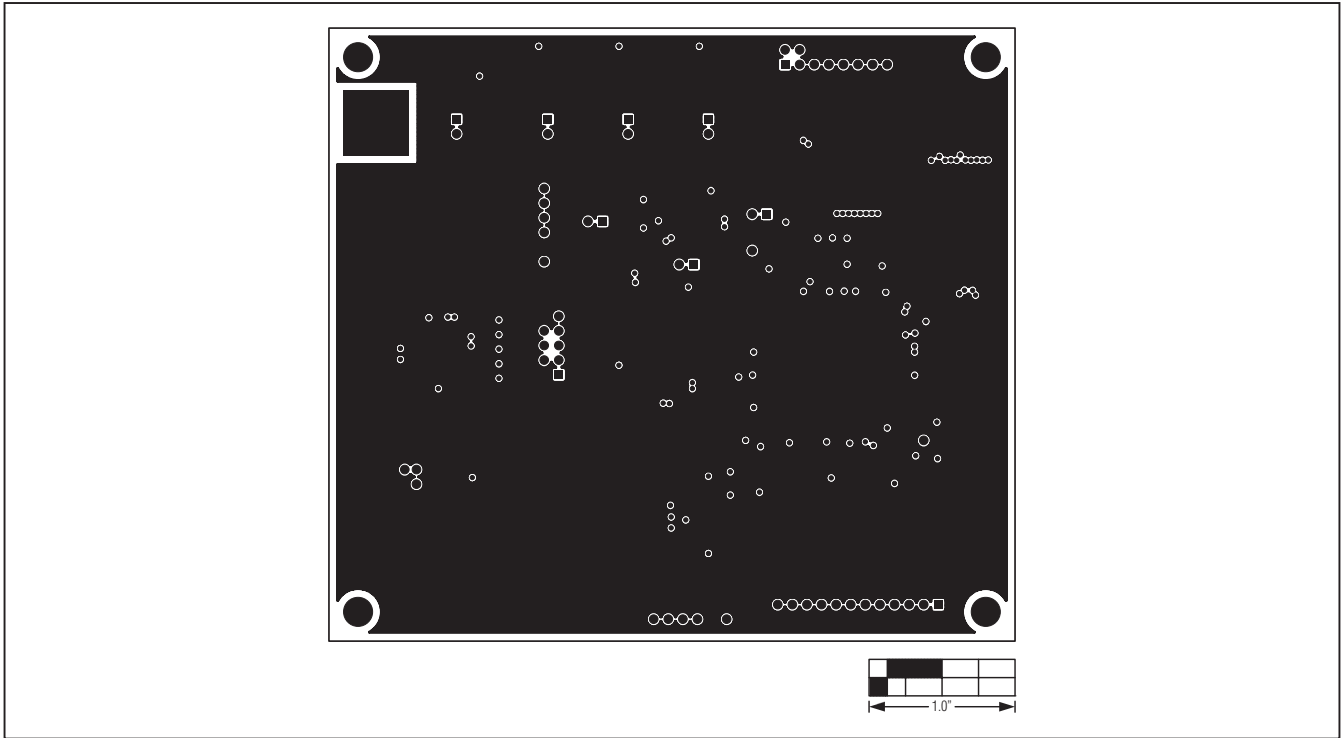

Figure 12. MAX116XX I2C Master Board PCB Layout—Layer 2

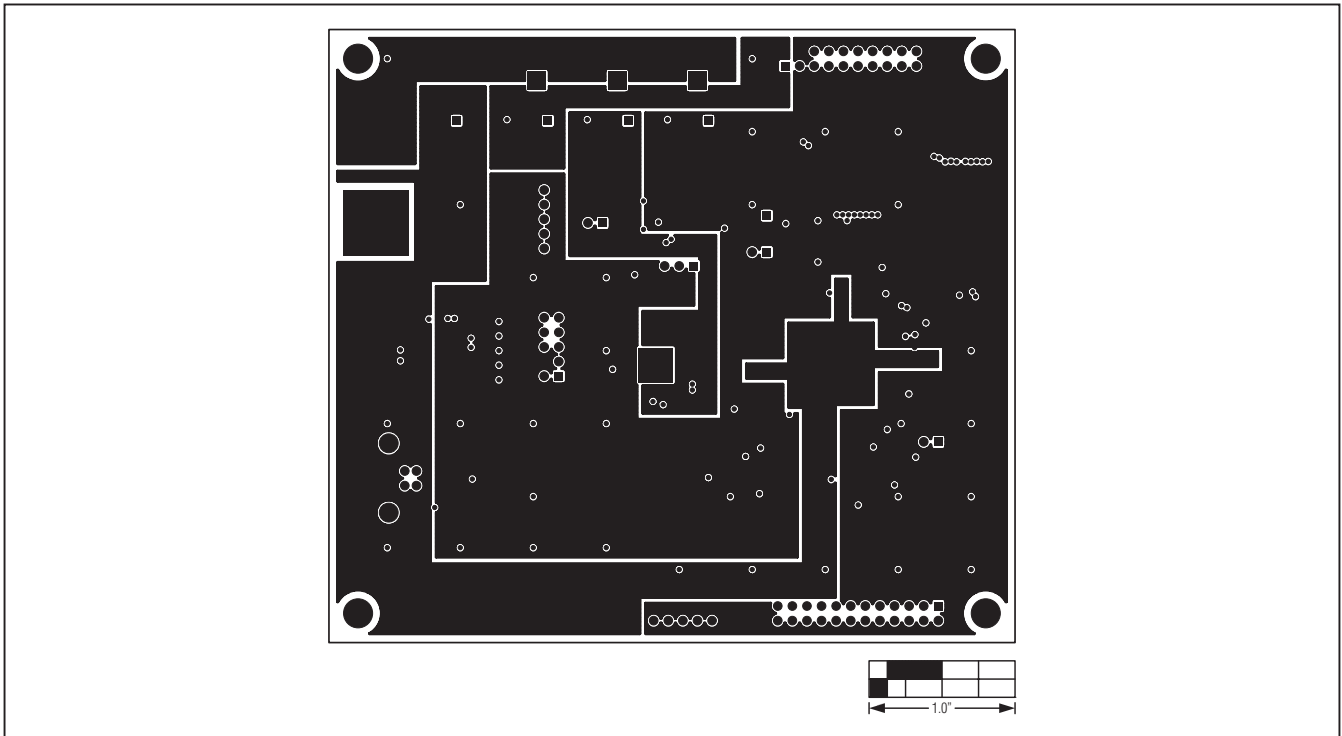

Figure 13. MAX116XX I2C Master Board PCB Layout—Layer 3



# MAX11600-MAX11617 Evaluation System

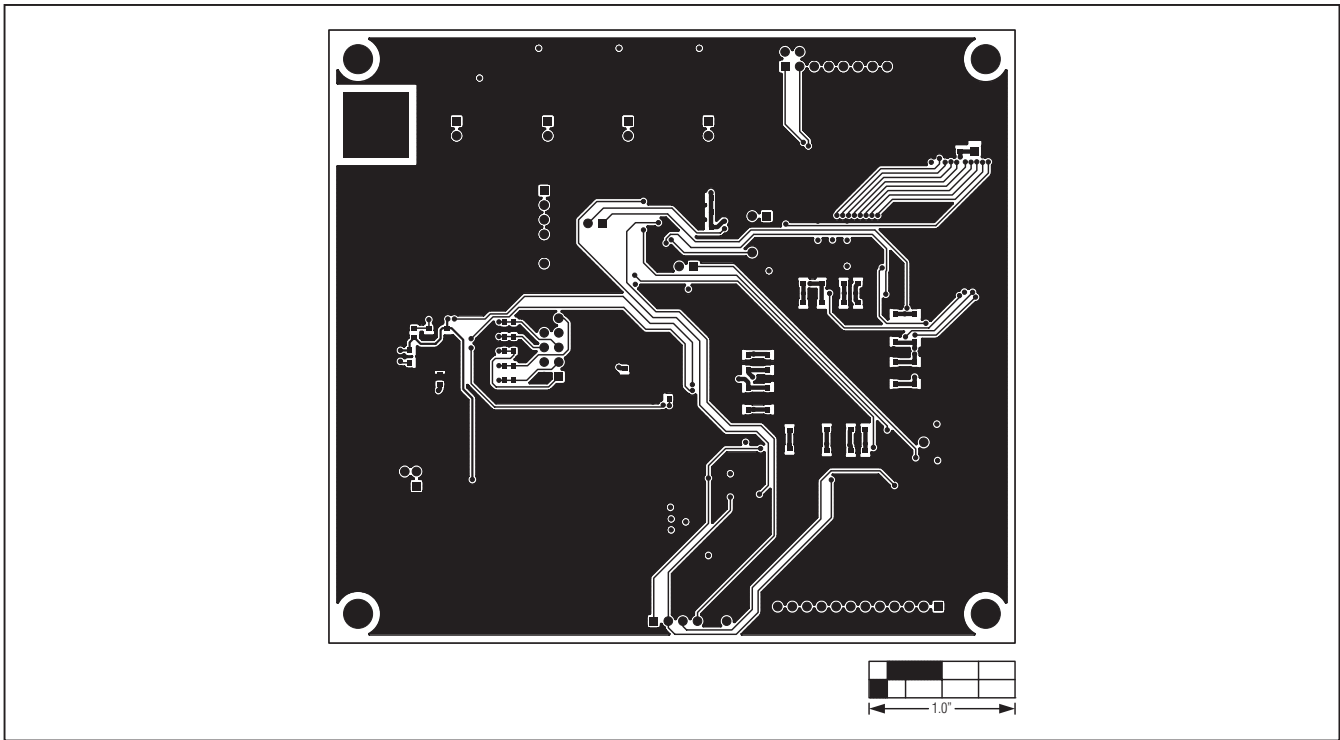

Figure 14. MAX116XX I2C Master Board PCB Layout—Bottom Side

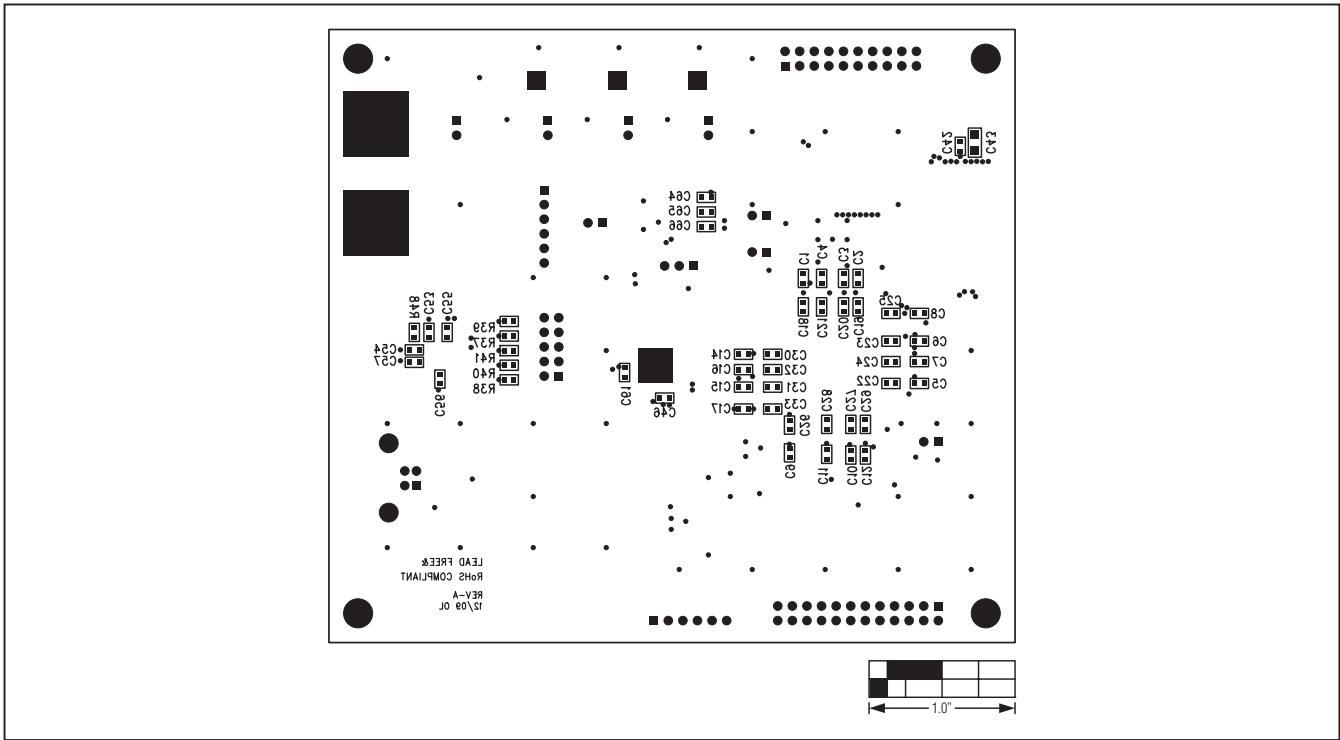

Figure 15. MAX116XX I2C Master Board Component Placement Guide—Bottom

# MAX11600-MAX11617 Evaluation System

Evaluates: MAX11600-MAX11617

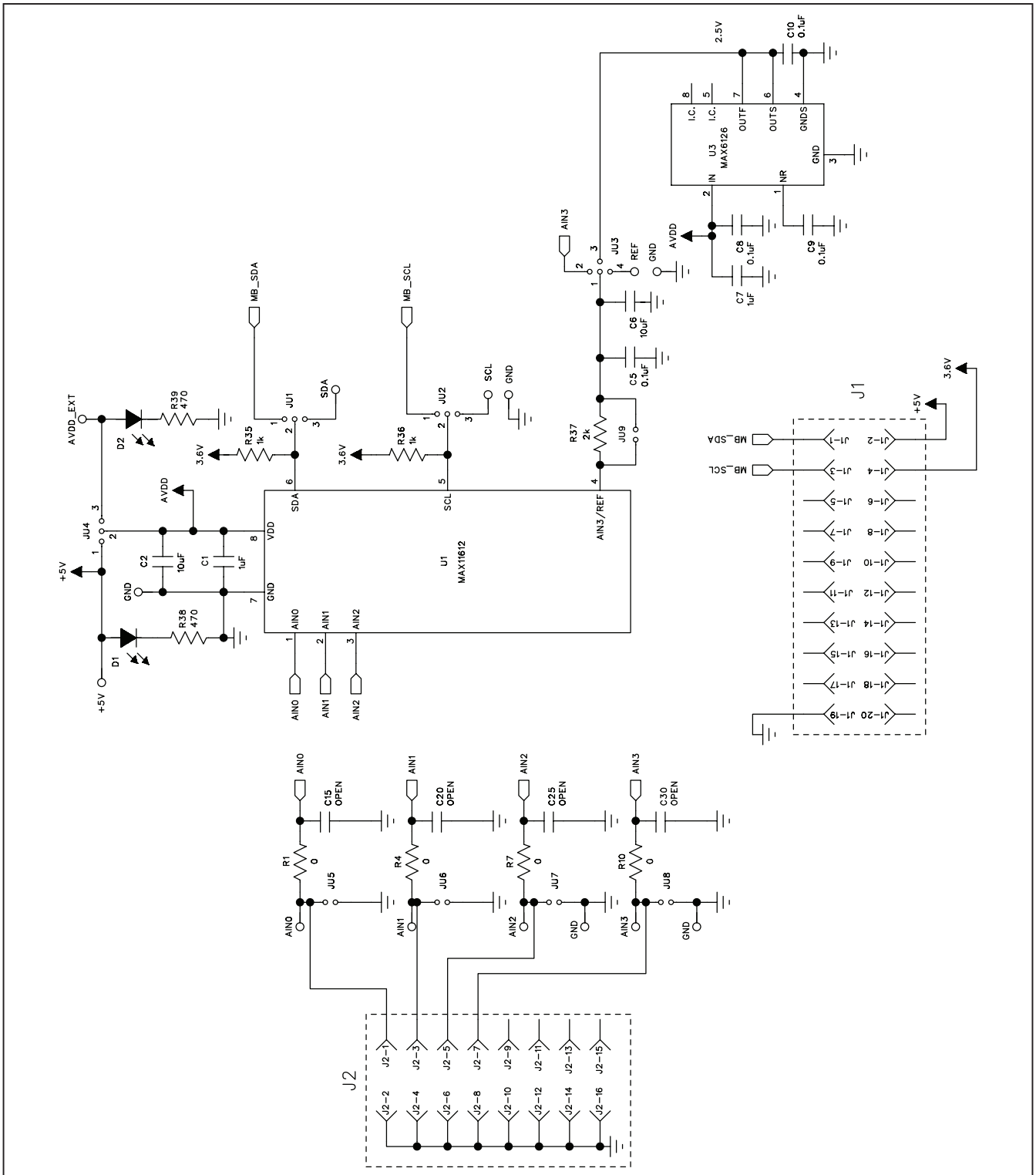

Figure 16. MAX11612 EV Kit Daughter Board Schematic