



Chipsmall Limited consists of a professional team with an average of over 10 year of expertise in the distribution of electronic components. Based in Hongkong, we have already established firm and mutual-benefit business relationships with customers from,Europe,America and south Asia,supplying obsolete and hard-to-find components to meet their specific needs.

With the principle of “Quality Parts,Customers Priority,Honest Operation,and Considerate Service”,our business mainly focus on the distribution of electronic components. Line cards we deal with include Microchip,ALPS,ROHM,Xilinx,Pulse,ON,Everlight and Freescale. Main products comprise IC,Modules,Potentiometer,IC Socket,Relay,Connector.Our parts cover such applications as commercial,industrial, and automotives areas.

We are looking forward to setting up business relationship with you and hope to provide you with the best service and solution. Let us make a better world for our industry!



Contact us

Tel: +86-755-8981 8866 Fax: +86-755-8427 6832

Email & Skype: info@chipsmall.com Web: www.chipsmall.com

Address: A1208, Overseas Decoration Building, #122 Zhenhua RD., Futian, Shenzhen, China



MAX14611

Quad Bidirectional Low-Voltage Logic-Level Translator

General Description

The MAX14611 is a quad bidirectional logic-level translator that provides the level shifting necessary to allow data transfer in a multivoltage system. Externally applied voltages, V_{CC} and V_L , set the logic levels on either side of the device. A low-voltage logic signal present on the V_L side of the device appears as a high-voltage logic signal on the V_{CC} side of the device, and vice-versa.

The device is ideal for I²C bus as well as MDIO bus applications where open-drain operation is often required. The device features a three-state output mode (\overline{TS}). Drive \overline{TS} high to connect the pullup to the powered I/O port. This allows for continuous, undisrupted I²C operation on the powered side of the device while the level translation function is off. The MAX14611 is a pin-to-pin compatible upgrade to the MAX3378E in the TDFN package.

The MAX14611 features enhanced high-electrostatic-discharge (ESD) protection on all I/OVCC_ ports up to $\pm 6kV$ HBM. The device operates over the $-40^{\circ}C$ to $+85^{\circ}C$ extended temperature range and is available in 3mm x 3mm, 14-pin TDFN and 4.9mm x 5.1mm, 14-pin TSSOP packages.

Applications

SPI, I ² C, and MDIO Level Translation	Mobile Phones
Low-Voltage ASIC Level Translation	POS Systems
Portable Electronics	Telecommunications Equipment

Benefits and Features

- ◆ **Improved Interoperability**
 - ◇ Meets I²C Specifications
 - ◇ 10k Ω Internal Pullup Resistor
 - ◇ Pin-to-Pin Compatible with the MAX3377E and the MAX3378E
 - ◇ 0.9V Operation on Low Voltage Supply
- ◆ **Robust Logic-Level Translation**
 - ◇ $\pm 0.5V$ Tolerances on All Pins
 - ◇ $\pm 6kV$ Human Body Model ESD Protection on I/OVCC_ Lines
 - ◇ Thermal Short-Circuit Protection
 - ◇ Short to Ground Fault Protection on All Pins
 - ◇ $-40^{\circ}C$ to $+85^{\circ}C$ Operating Temperature Range
- ◆ **Increased Design Flexibility**
 - ◇ Ultra-Low Supply Current
 - ◇ Pullup Resistor Enabled with a Single Power Supply when $\overline{TS} = \text{High}$
 - ◇ 10 Ω (max) Transmission Gate FET
 - ◇ Small, 14-Pin, 3.0mm x 3.0mm TDFN Package and 14-Pin, 4.9mm x 5.1mm TSSOP Package

Ordering Information appears at end of data sheet.

Typical Operating Circuit

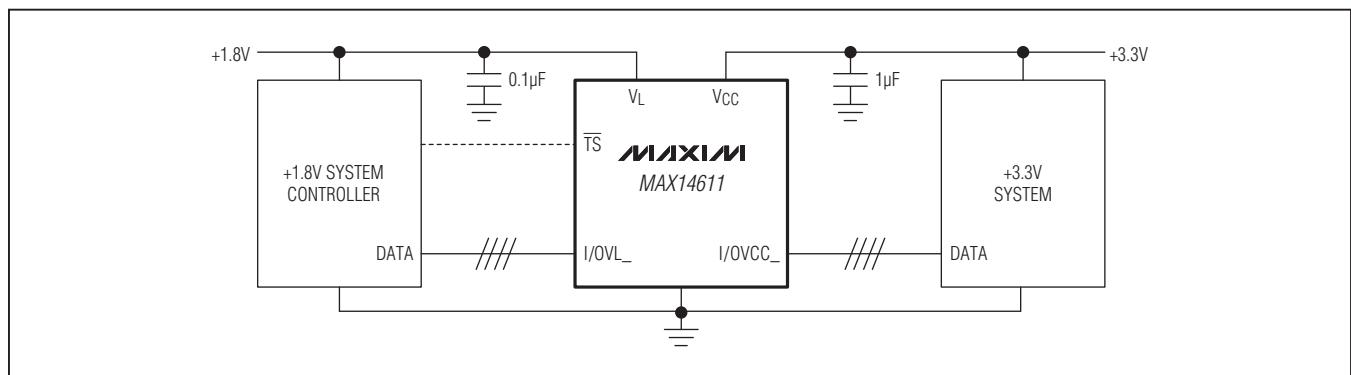

For related parts and recommended products to use with this part, refer to www.maxim-ic.com/MAX14611.related.

Quad Bidirectional Low-Voltage Logic-Level Translator

ABSOLUTE MAXIMUM RATINGS

(All voltages referenced to GND.)

V_{CC}	-0.5V to +6V
V_L	-0.5V to +5.5V
\overline{TS}	-0.5V to +6V
I/OVCC_.....	-0.5V to ($V_{CC} + 0.5V$)
I/OVL_.....	-0.5V to ($V_L + 0.5V$)
Short-Circuit Duration I/OVL_ , I/OVCC_ to GND.....	Continuous
Continuous Current	$\pm 50mA$

Continuous Power Dissipation ($T_A = +70^\circ C$)

TDFN (derate 24.4mW/ $^\circ C$ above +70 $^\circ C$)	1951.2mW
TSSOP (derate 10mW/ $^\circ C$ above +70 $^\circ C$)	796.8mW
Operating Temperature Range	-40 $^\circ C$ to +85 $^\circ C$
Maximum Junction Temperature.....	+150 $^\circ C$
Storage Temperature Range.....	-65 $^\circ C$ to +150 $^\circ C$
Lead Temperature (soldering, 10s)	+300 $^\circ C$
Soldering Temperature (reflow)	+260 $^\circ C$

Stresses beyond those listed under "Absolute Maximum Ratings" may cause permanent damage to the device. These are stress ratings only, and functional operation of the device at these or any other conditions beyond those indicated in the operational sections of the specifications is not implied. Exposure to absolute maximum rating conditions for extended periods may affect device reliability.

PACKAGE THERMAL CHARACTERISTICS (Note 1)

TDFN-EP

Junction-to-Ambient Thermal Resistance (θ_{JA}).....	41 $^\circ C/W$
Junction-to-Case Thermal Resistance (θ_{JC}).....	8 $^\circ C/W$

TSSOP

Junction-to-Ambient Thermal Resistance (θ_{JA}).....	100.4 $^\circ C/W$
Junction-to-Case Thermal Resistance (θ_{JC}).....	30 $^\circ C/W$

Note 1: Package thermal resistances were obtained using the method described in JEDEC specification JESD51-7, using a four-layer board. For detailed information on package thermal considerations, refer to www.maxim-ic.com/thermal-tutorial.

ELECTRICAL CHARACTERISTICS

($V_{CC} = +1.65V$ to +5.5V, $V_L = 0.9V$ to the lesser of $V_{CC} + 0.3V$ and 5V. $T_A = T_J = -40^\circ C$ to +85 $^\circ C$, unless otherwise noted. Typical values are at $V_{CC} = +3.3V$, $V_L = +1.8V$, $T_A = +25^\circ C$, unless otherwise noted.) (Notes 2, 3)

PARAMETER	SYMBOL	CONDITIONS	MIN	TYP	MAX	UNITS
POWER SUPPLIES						
V_L Supply Range	V_L		0.9		5	V
V_{CC} Supply Range	V_{CC}		1.65		5.5	V
V_L Supply Current	I_{VL}	I/OVCC_ = V_{CC} , I/OVL_ = V_L , $\overline{TS} = V_L$			1	μA
V_{CC} Supply Current	I_{VCC}	I/OVCC_ = V_{CC} , I/OVL_ = V_L , $\overline{TS} = V_L$			35	μA
V_{CC} Shutdown Mode Supply Current	I_{SHDN_VCC}	$\overline{TS} = GND$, I/OVCC = unconnected		0.1	1	μA
		$\overline{TS} = V_{CC}$, $V_L = GND$, I/OVCC = unconnected		0.1	1	
V_L Shutdown Mode Supply Current	I_{SHDN_VL}	$\overline{TS} = GND$		0.1	1	μA
		$\overline{TS} = V_L$, $V_{CC} = GND$, I/OVL_ = unconnected		0.1	1	
I/OVCC_ , I/OVL_ , \overline{TS} Leakage Current	I_{LEAK}	$T_A = +25^\circ C$, $\overline{TS} = GND$		0.1	1	μA
\overline{TS} Input Leakage Current	I_{LEAK_TS}	$T_A = +25^\circ C$			1	μA
V_L Shutdown Threshold	V_{TH_VL}			0.3	0.85	V
V_{CC} Shutdown Threshold	V_{TH_VCC}			0.8	1.35	V
I/OVL_ Pullup Resistor	R_{VL_PU}			10		k Ω
I/OVCC_ Pullup Resistor	R_{VCC_PU}			10		k Ω

MAX14611

Quad Bidirectional Low-Voltage Logic-Level Translator

ELECTRICAL CHARACTERISTICS (continued)

($V_{CC} = +1.65V$ to $+5.5V$, $V_L = 0.9V$ to the lesser of $V_{CC} + 0.3V$ and $5V$. $T_A = T_J = -40^{\circ}C$ to $+85^{\circ}C$, unless otherwise noted. Typical values are at $V_{CC} = +3.3V$, $V_L = +1.8V$, $T_A = +25^{\circ}C$, unless otherwise noted.) (Notes 2, 3)

PARAMETER	SYMBOL	CONDITIONS	MIN	TYP	MAX	UNITS
I/OVL_ to I/OVCC_ DC Resistance	R_{IOVL_IOVCC}	Inferred from V_{OL} measurements		5	10	Ω
I/OVL_ Input-Voltage High	V_{IHL}		$V_L - 0.2$			V
I/OVL_ Input-Voltage Low	V_{ILL}				0.15	V
I/OVCC_ Input-Voltage High	V_{IHC}		$V_{CC} - 0.4$			V
I/OVCC_ Input-Voltage Low	V_{ILC}				0.2	V
I/OVL_ Output-Voltage High	V_{OHL}	I/OVL_ source current = $10\mu A$	$0.7 \times V_L$			V
I/OVL_ Output-Voltage Low	V_{OLL}	I/OVL_ sink current = $2mA$, $V_{I/OVCC_} \leq 50mV$			0.4	V
I/OVCC_ Output-Voltage High	V_{OHC}	I/OVCC_ source current = $10\mu A$	$0.7 \times V_{CC}$			V
I/OVCC_ Output Voltage Low	V_{OLC}	I/OVCC_ sink current = $2mA$, $V_{I/OVL_} \leq 150mV$			0.4	V
\overline{TS} Input-Voltage High Threshold	V_{IH}		$V_L - 0.2$			V
\overline{TS} Input-Voltage Low Threshold	V_{IL}	$V_L > 1.3V$			0.2	V
Accelerator Pulse Duration		Inferred from timing measurements			30	ns
V_L Output Accelerator Source Impedance		$V_L = 0.9V$		70		Ω
		$V_L = 3.3V$		15		
V_{CC} Output Accelerator Source Impedance		$V_{CC} = 1.65V$		50		Ω
		$V_{CC} = 5.0V$		10		
Thermal-Shutdown Threshold		$20^{\circ}C$ hysteresis		+150		$^{\circ}C$
ESD PROTECTION						
I/OVCC_		Human Body Model, $C_{VCC} = 1\mu F$, $C_{VL} = 0.1\mu F$		± 6		kV
All Other Pins		Human Body Model		± 2		kV

MAX14611

Quad Bidirectional Low-Voltage Logic-Level Translator

TIMING CHARACTERISTICS

($V_{CC} = +1.65V$ to $+5.5V$, $V_L = +0.9V$ to the lesser of $V_{CC} + 0.3V$ and $5V$, $\overline{TS} = V_L$, $R_L = 1M\Omega$, $C_{VCC} = 1\mu F$, $C_{VL} = 0.1\mu F$, $C_{I/OVCC_} = 15pF$, $C_{I/OVL_} = 15pF$, $T_A = -40^\circ C$ to $+85^\circ C$, unless otherwise noted. Typical values are $V_{CC} = +3.3V$, $V_L = +1.8V$, and $T_A = +25^\circ C$.) (Note 4)

PARAMETER	SYMBOL	CONDITIONS	MIN	TYP	MAX	UNITS
I/OVCC_ Rise Time	t_{RVCC}	Push-pull driving (Figure 1)			40	ns
		Open-drain driving (Figure 2, Note 5)			100	
I/OVCC_ Fall Time	t_{FVCC}	Push-pull driving (Figure 1)			40	ns
		Open-drain driving (Figure 2, Note 5)			50	
I/OVL_ Rise Time	t_{RVL}	Push-pull driving (Figure 3)			30	ns
		Open-drain driving (Figure 4, Note 5)			105	
I/OVL_ Fall Time	t_{FVL}	Push-pull driving (Figure 3)			30	ns
		Open-drain driving (Figure 4, Note 5)			30	
Propagation Delay	I/OVL-VCC	Push-pull driving (Figure 1)			40	ns
	I/OVL-VCC	Open-drain driving (Figure 2, Note 5)			150	
Propagation Delay	I/OVCC-VL	Push-pull driving (Figure 3)			30	ns
	I/OVCC-VL	Open-drain driving (Figure 4, Note 5)			105	
Channel-to-Channel Skew	t_{SKEW}	Input rise time/fall time < 6ns, push-pull driving			20	ns
		Input rise time/fall time < 6ns, open-drain driving			50	
Maximum Data Rate		Push-pull operation			20	Mbps
		Open-drain operation (Notes 5, 6)			6	

Note 2: All units are 100% production tested at $T_A = +25^\circ C$. Specifications over operating temperature range are guaranteed by design.

Note 3: V_L must be less than or equal to V_{CC} during normal operation. However, V_L can be greater than V_{CC} during startup and shutdown conditions.

Note 4: All timing is 10% to 90% for rise time and 90% to 10% for fall time.

Note 5: Not production tested; guaranteed by design.

Note 6: Requires the external pullup resistor.

MAX14611

Quad Bidirectional Low-Voltage Logic-Level Translator

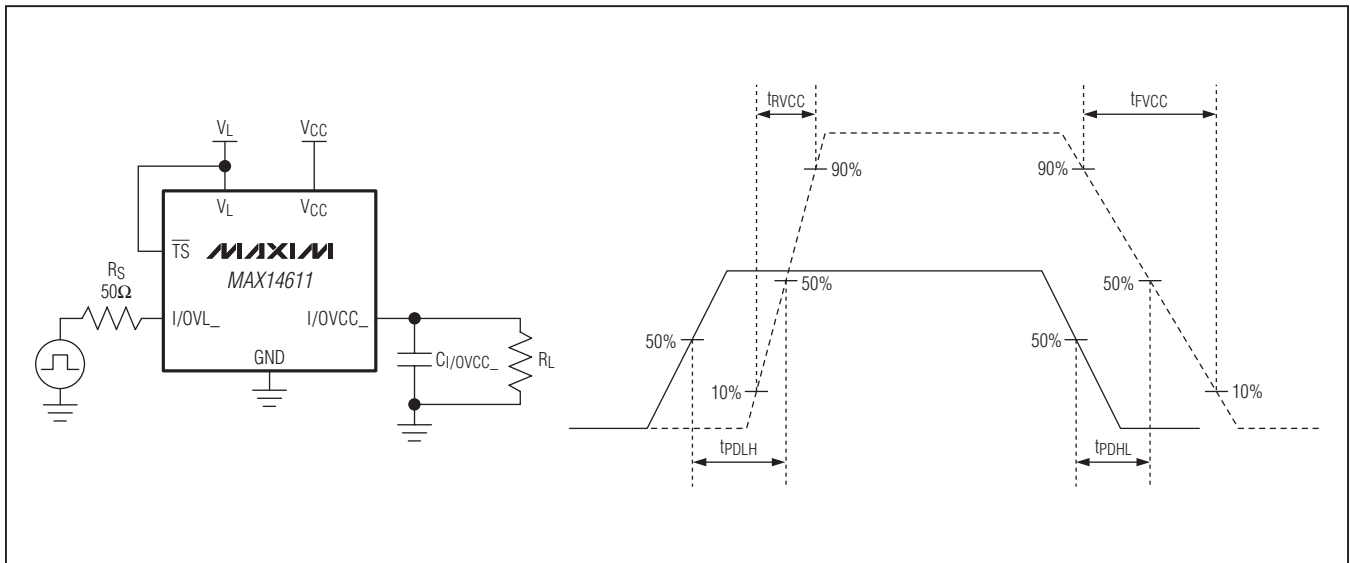

Figure 1. Push-Pull Driving I/OVL_

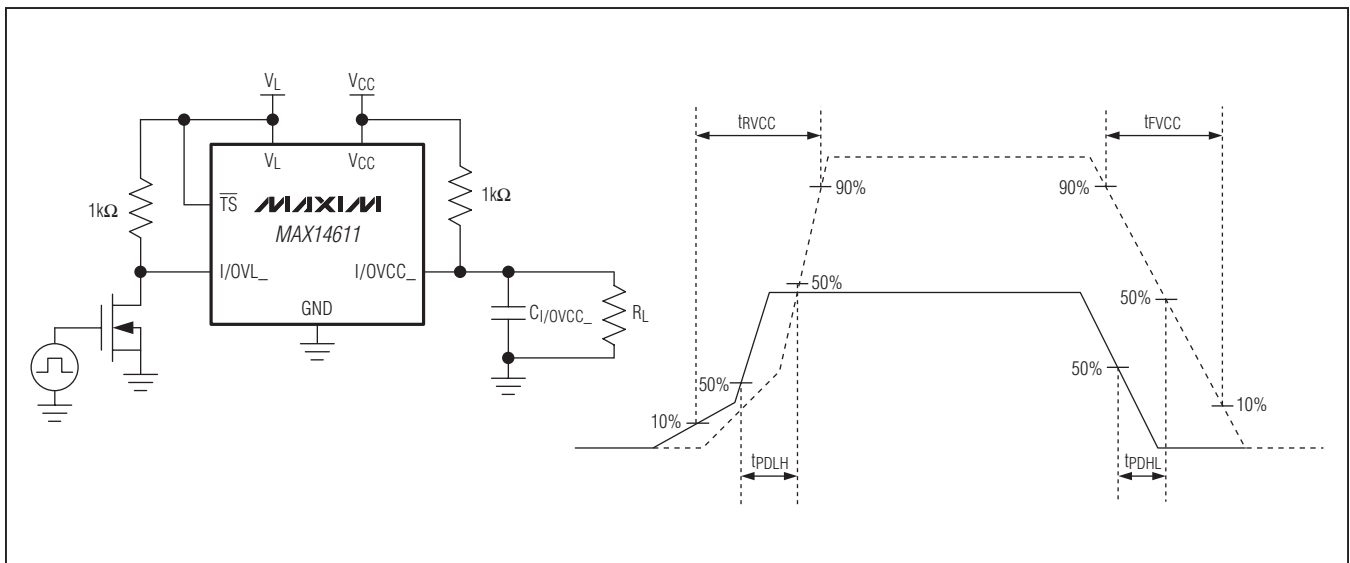

Figure 2. Open-Drain Driving I/OVL_

MAX14611

Quad Bidirectional Low-Voltage Logic-Level Translator

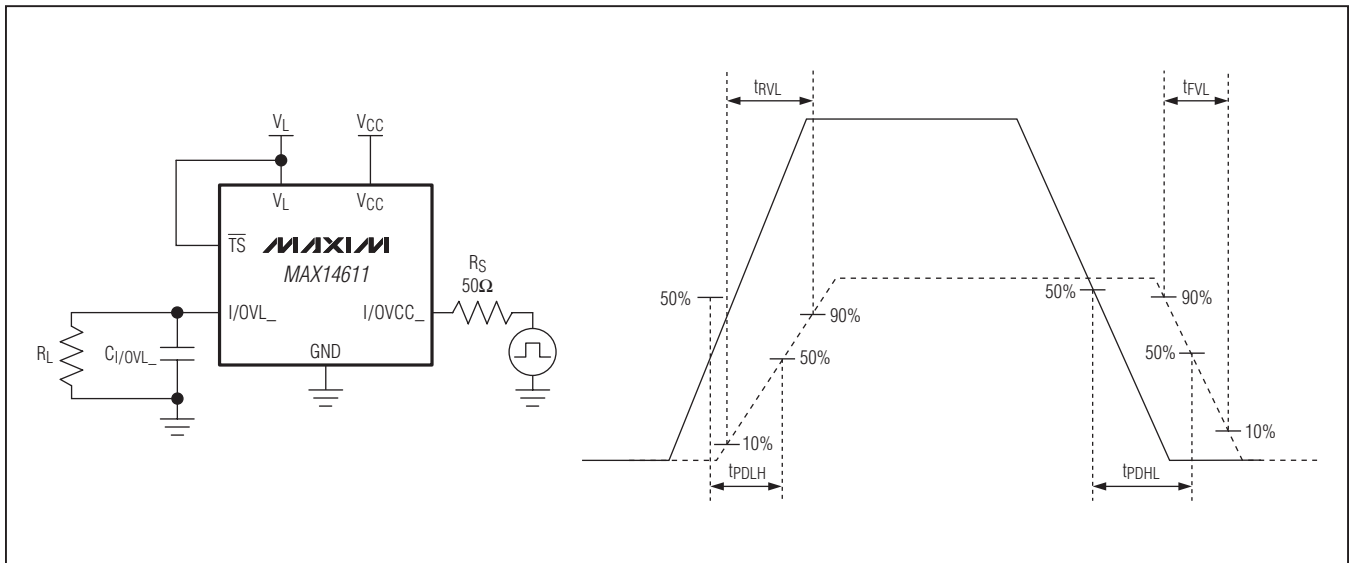

Figure 3. Push-Pull Driving $I/OVCC_$

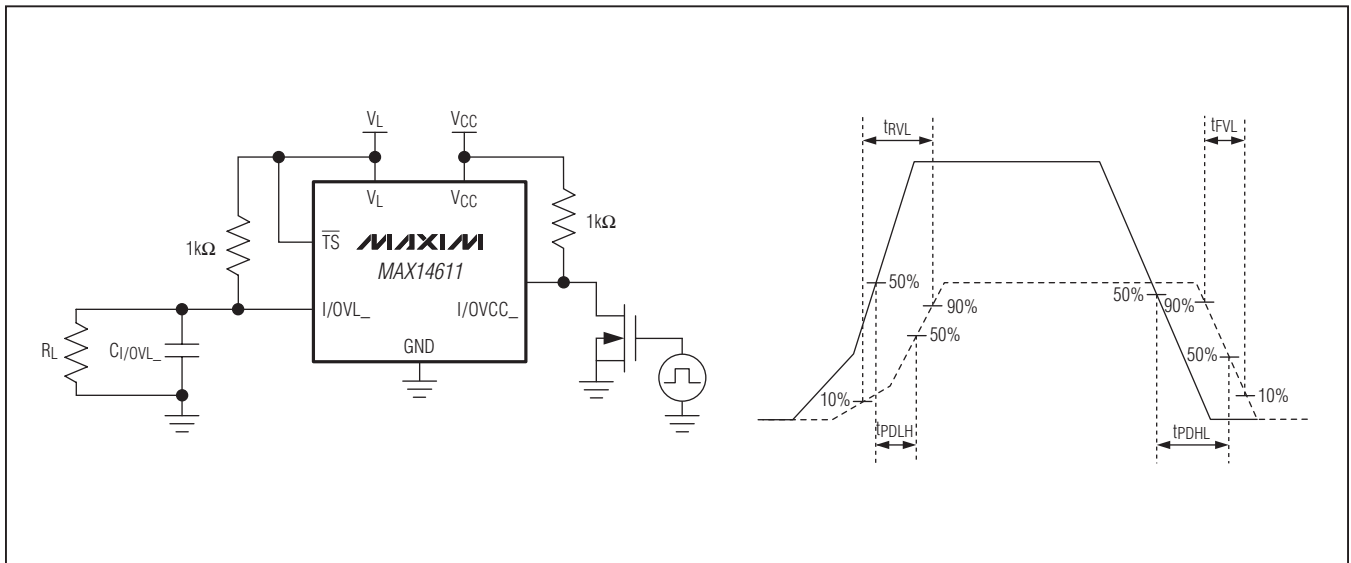

Figure 4. Open-Drain Driving $I/OVCC_$

MAX14611

Quad Bidirectional Low-Voltage Logic-Level Translator

Typical Operating Characteristics

($V_{CC} = +3.3V$, $V_L = 1.8V$, $R_L = 1M\Omega$, $C_L = 15pF$, $T_A = +25^\circ C$, data rate = 500kbps in open-drain operation and 8Mbps in push-pull operation, unless otherwise noted.)

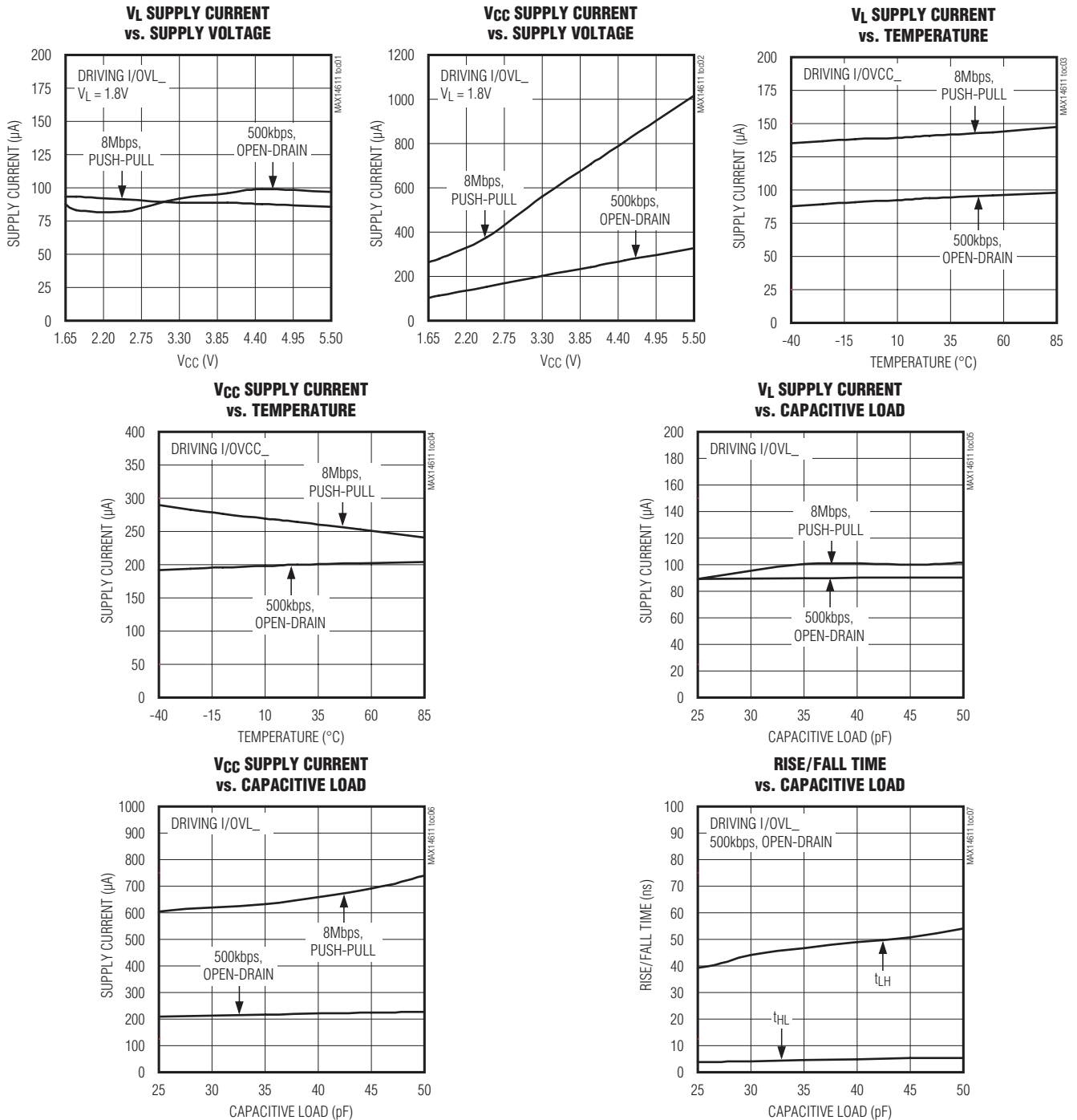

MAX14611

Quad Bidirectional Low-Voltage Logic-Level Translator

Typical Operating Characteristics (continued)

($V_{CC} = +3.3V$, $V_L = 1.8V$, $R_L = 1M\Omega$, $C_L = 15pF$, $T_A = +25^\circ C$, data rate = 500kbps in open-drain operation and 8Mbps in push-pull operation, unless otherwise noted.)

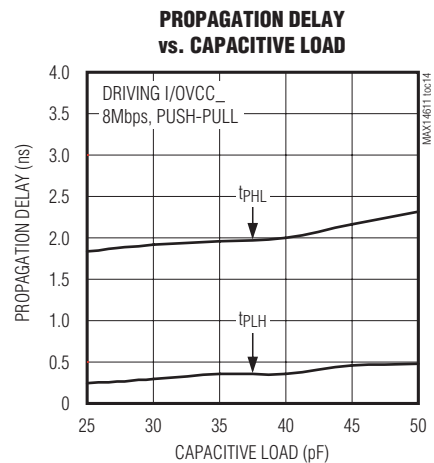
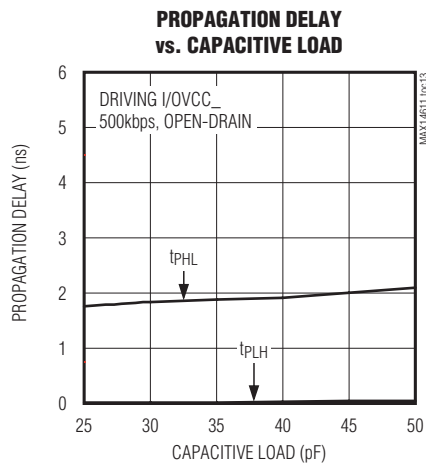
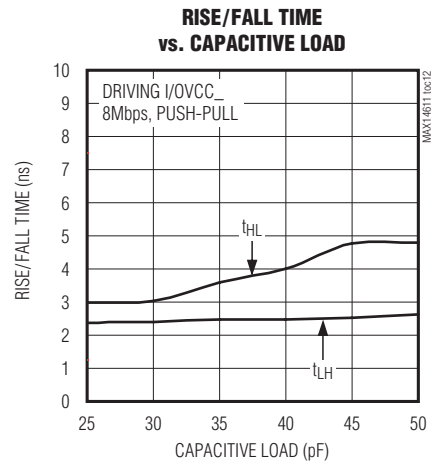
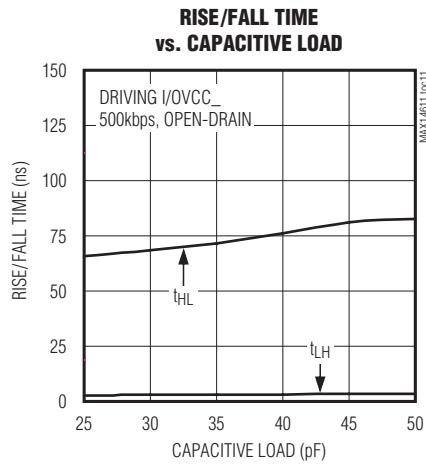
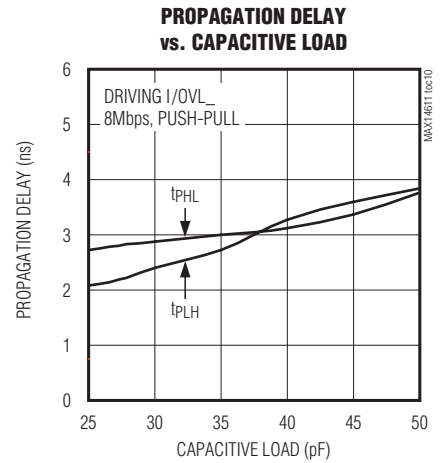
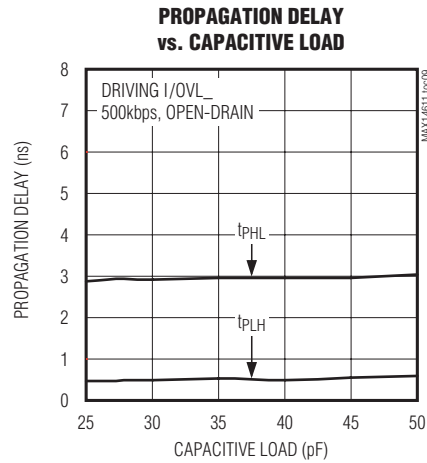
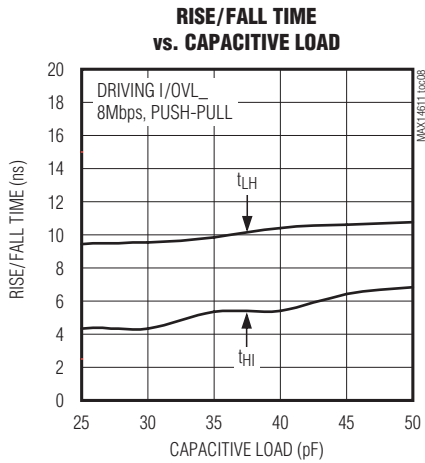

MAX14611

Quad Bidirectional Low-Voltage Logic-Level Translator

Typical Operating Characteristics (continued)

($V_{CC} = +3.3V$, $V_L = 1.8V$, $R_L = 1M\Omega$, $C_L = 15pF$, $T_A = +25^\circ C$, data rate = 500kbps in open-drain operation and 8Mbps in push-pull operation, unless otherwise noted.)

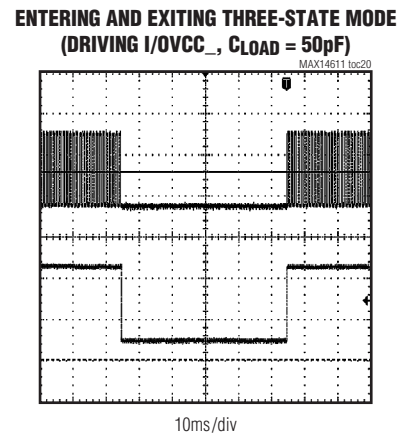
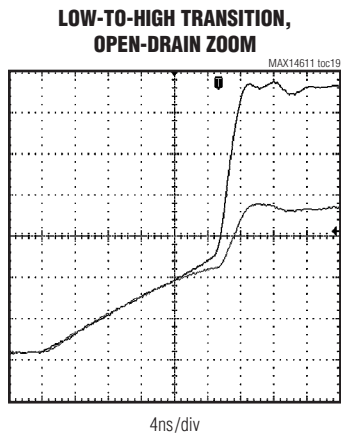
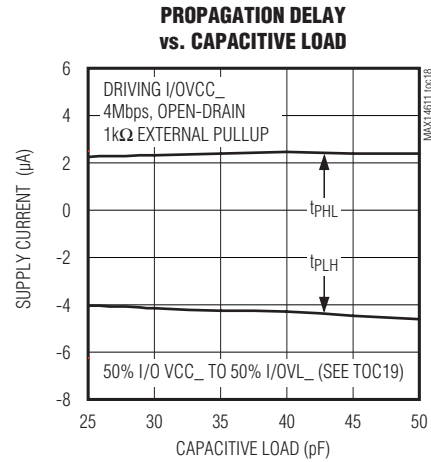
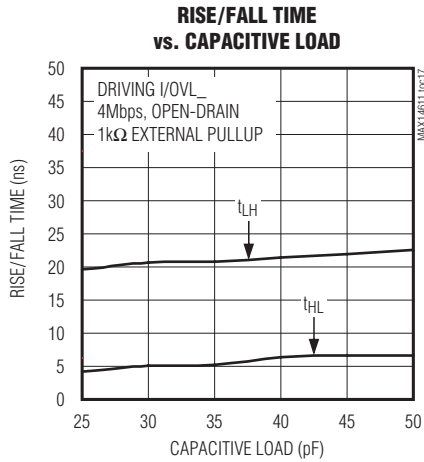
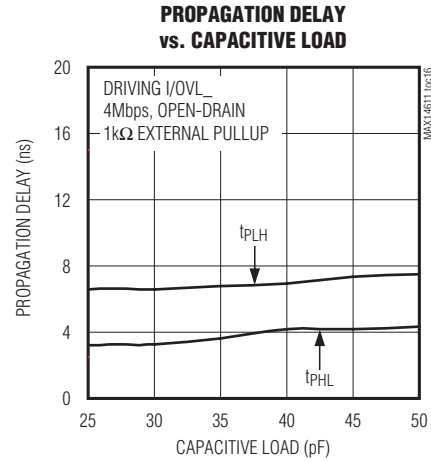
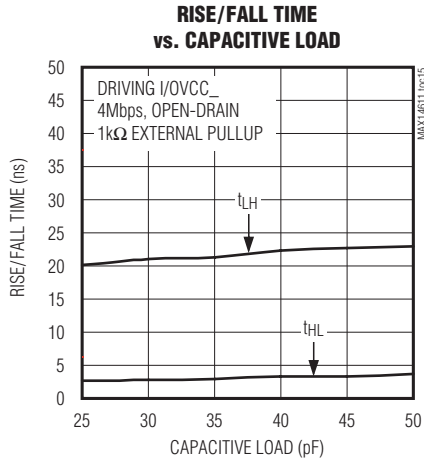

MAX14611

Quad Bidirectional Low-Voltage Logic-Level Translator

Pin Configurations

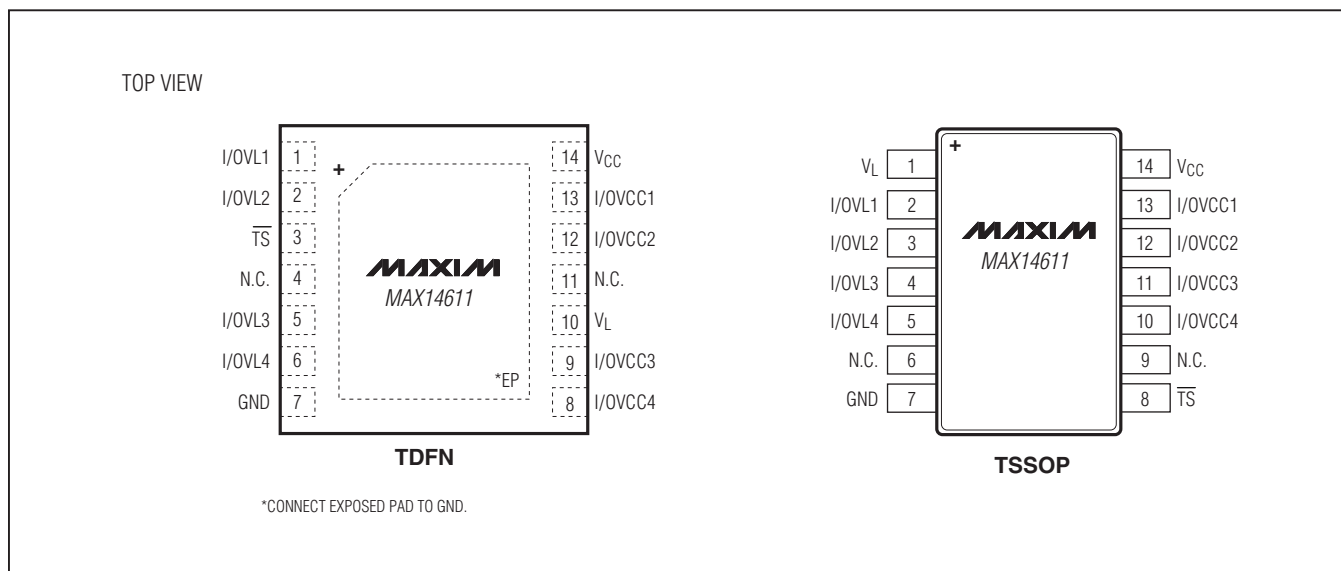

Pin Description

PIN		NAME	FUNCTION
TDFN-EP	TSSOP		
1	2	I/OVL1	Input/Output 1. Reference to V_L .
2	3	I/OVL2	Input/Output 2. Reference to V_L .
3	8	\overline{TS}	Three-State Select Input. Drive \overline{TS} low to place the device in three-state output mode. I/OVCC_ and I/OVL_ are high impedance in three-state output mode. Note: Logic referenced to V_L (for logic thresholds, see the <i>Electrical Characteristics</i> table).
4, 11	6,9	N.C.	No Connection. Not internally connected.
5	4	I/OVL3	Input/Output 3. Reference to V_L .
6	5	I/OVL4	Input/Output 4. Reference to V_L .
7	7	GND	Ground
8	10	I/OVCC4	Input/Output 4. Reference to V_{CC} .
9	11	I/OVCC3	Input/Output 3. Reference to V_{CC} .
10	1	V_L	Logic Supply Voltage Input, $0.9V \leq V_L \leq \min(5.0V, (V_{CC} + 0.3V))$. Connect a 0.1 μ F ceramic capacitor as close as possible to the pin.
12	12	I/OVCC2	Input/Output 2. Reference to V_{CC} .
13	13	I/OVCC1	Input/Output 1. Reference to V_{CC} .
14	14	V_{CC}	Power Supply Input. The supply range is $1.65V \leq V_{CC} \leq 5.5V$. Bypass V_{CC} with a 1 μ F ceramic capacitor as close as possible to the pin to achieve higher ESD protection ($\pm 6kV$ HBM).
—	—	EP	Exposed Pad (TDFN Only). EP is internally connected to GND. Connect to a large ground plane to maximize thermal performance. Not intended as an electrical connection point.

MAX14611

Quad Bidirectional Low-Voltage Logic-Level Translator

Functional Diagram

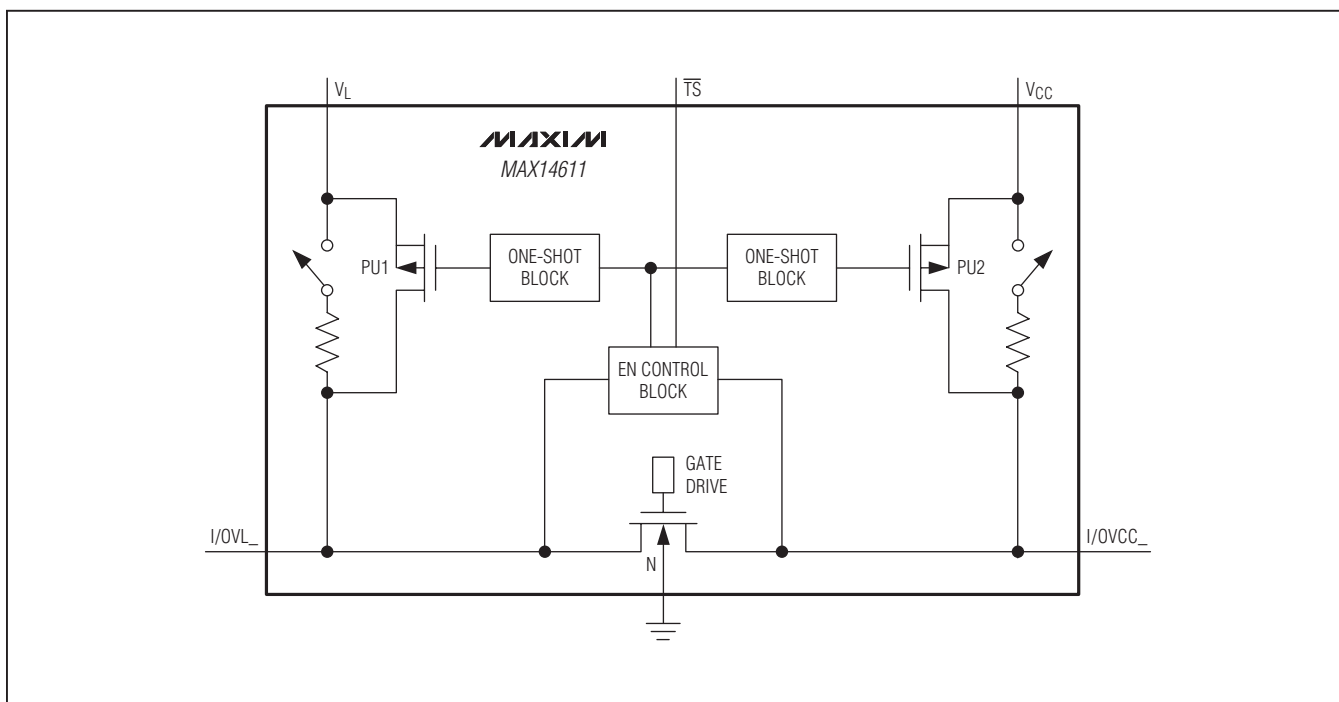

Detailed Description

The MAX14611 ESD-protected level translator provides the level shifting necessary to allow data transfer in a multivoltage system. Externally applied voltages, V_{CC} and V_L , set the logic levels on either side of the device. A low-voltage logic signal present on the V_L side of the device appears as a high-voltage logic signal on the V_{CC} side of the device, and vice-versa.

The MAX14611 bidirectional level translator utilizes a transmission-gate based design (see the [Functional Diagram](#)) to allow data translation in either direction ($V_L \leftrightarrow V_{CC}$) on any single data line. The device accepts V_L from +0.9V to +5.0V and V_{CC} from +1.65V to +5.5V, making it ideal for data transfer between low-voltage ASICs/PLDs and higher voltage systems.

The device features a three-state output mode, thermal short-circuit protection, and ± 6 kV ESD protection on the V_{CC} side for greater protection in applications that route signals externally.

Level Translation

For proper operation, ensure that $+1.65\text{V} \leq V_{CC} \leq +5.5\text{V}$, $0.9\text{V} \leq V_L \leq 5.0\text{V}$, and $V_L \leq (V_{CC} + 0.3\text{V})$. It is permissible for V_L to exceed $(V_{CC} + 0.3\text{V})$ during power-up sequencing. During power-supply sequencing, when V_{CC} is disconnected and V_L is powered up, a current can be sourced without a latching or any damage to the device. The maximum data rate of the MAX14611 depends heavily on load capacitance (see the [Typical Operating Characteristics](#)), output impedance of the driver, and the operational voltage (see the [Timing Characteristics](#) table).

Speed-Up Circuitry

The device features a one-shot generator that decreases the rise time of the output. When triggered following a rising edge, MOSFETs PU1 and PU2 turn on for a short time to pull up I/OVL_ and I/OVCC_ to their respective supplies (see the [Functional Diagram](#)). This greatly reduces the rise time and propagation delay for the low-to-high transition.

MAX14611

Quad Bidirectional Low-Voltage Logic-Level Translator

Rise-Time Accelerators (Figure 5)

The device has internal rise-time accelerators, allowing operation up to 20Mbps. The rise-time accelerators are present on both sides of the device and act to speed up the rise time of the input and output of the device, regardless of the direction of the data. The triggering mechanism for these accelerators is both level and edge sensitive. To prevent false triggering of the rise-time accelerators and to take full advantage of them, signal rise/fall times of less than 2ns/V are recommended for both sides of the device in open-drain driving. The recommendation applies only for fall time. Under less noisy conditions, longer signal fall times can be acceptable.

Three-State Output Mode (\overline{TS})

Drive \overline{TS} low to place the device in three-state output mode. Connect \overline{TS} to V_L (logic-high) for normal operation. Activating the three-state output mode disconnects the internal 10k Ω pullup resistors on the I/OVCC_ and I/OVL_ lines. This forces the I/O lines to a high-impedance state and decreases the supply current to less than 1 μ A. The high-impedance I/O lines in three-state output mode allow for use in a multidrop network. When in three-state output mode, keep the I/OVL_ voltage below ($V_L + 0.3V$), and keep the I/OVCC_ voltage below ($V_{CC} + 0.3V$).

Thermal Short-Circuit Protection

Thermal-overload detection protects the device from short-circuit fault conditions. In the event of a short-circuit fault and when the junction temperature (T_J) reaches +150°C (typ), a thermal sensor signals the three-state output mode logic to force the device into three-state output mode. When T_J has cooled to +130°C (typ), normal operation resumes.

High ESD Protection

As with all Maxim devices, ESD-protection structures are incorporated on all pins to protect against electrostatic

discharges encountered during handling and assembly. The I/OVCC_ lines have extra protection against static electricity. Maxim's engineers have developed state-of-the-art structures to protect these pins against ESD of $\pm 6kV$ without damage.

The ESD structures withstand high ESD in all states: normal operation, three-state output mode, and powered down. After an ESD event, the device keeps working without latchup, whereas competing products can latch and must be powered down to remove latchup. ESD protection can be tested in various ways. The I/OVCC_ lines of this product family are characterized for protection to $\pm 6kV$ using the Human Body Model.

ESD Test Conditions

Contact Maxim for a reliability report that documents test setup, test methodology, and test results.

Applications Information

Power-Supply Decoupling

Bypass V_L to ground with a 0.1 μ F capacitor to reduce ripple and ensure correct data transmission. See the [Typical Operating Circuit](#). To ensure full $\pm 6kV$ ESD protection, bypass V_{CC} to ground with a 1 μ F capacitor. Place all capacitors as close as possible to the power-supply pins (V_{CC} and V_L).

Push-Pull vs. Open-Drain Driving

The device can be driven in a push-pull configuration. The device includes internal 10k Ω resistors that pull up I/OVL_ and I/OVCC_ to their respective power supplies, allowing operation of the I/O lines with open-drain devices. See the [Timing Characteristics](#) table for maximum data rates when using open-drain drivers ([Figure 1](#), [Figure 2](#), [Figure 3](#), [Figure 4](#)).

MAX14611

Quad Bidirectional Low-Voltage Logic-Level Translator

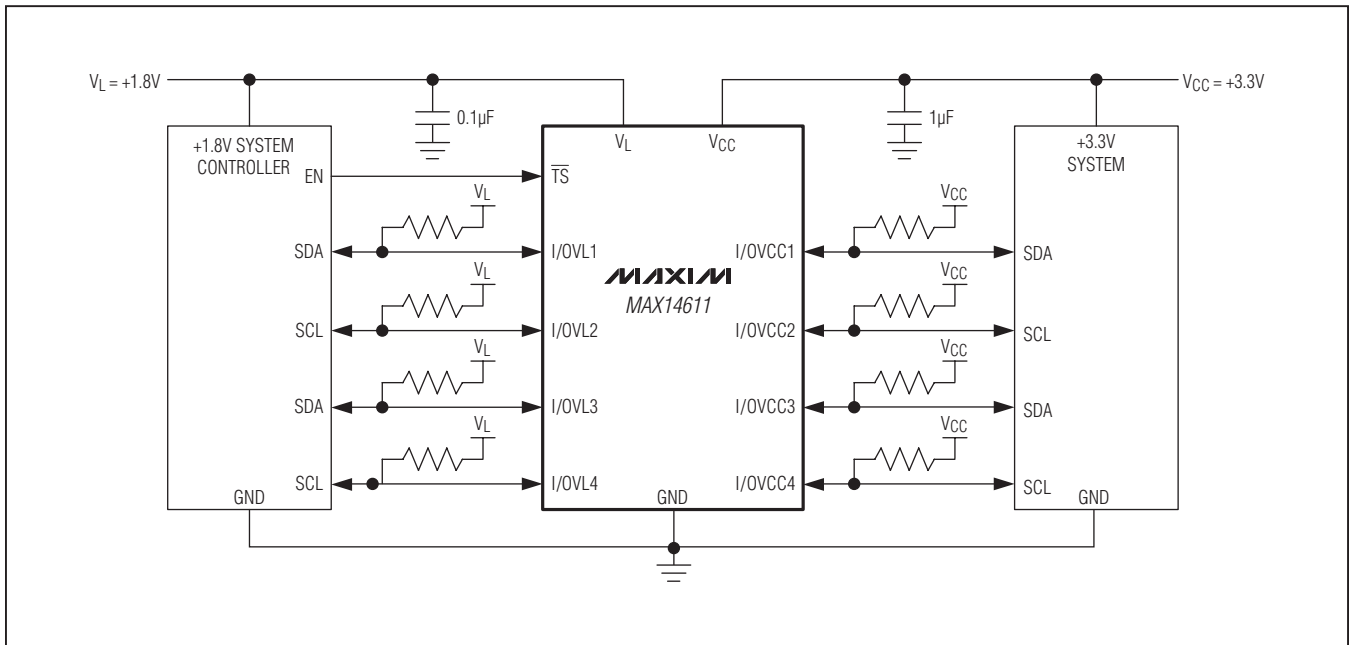
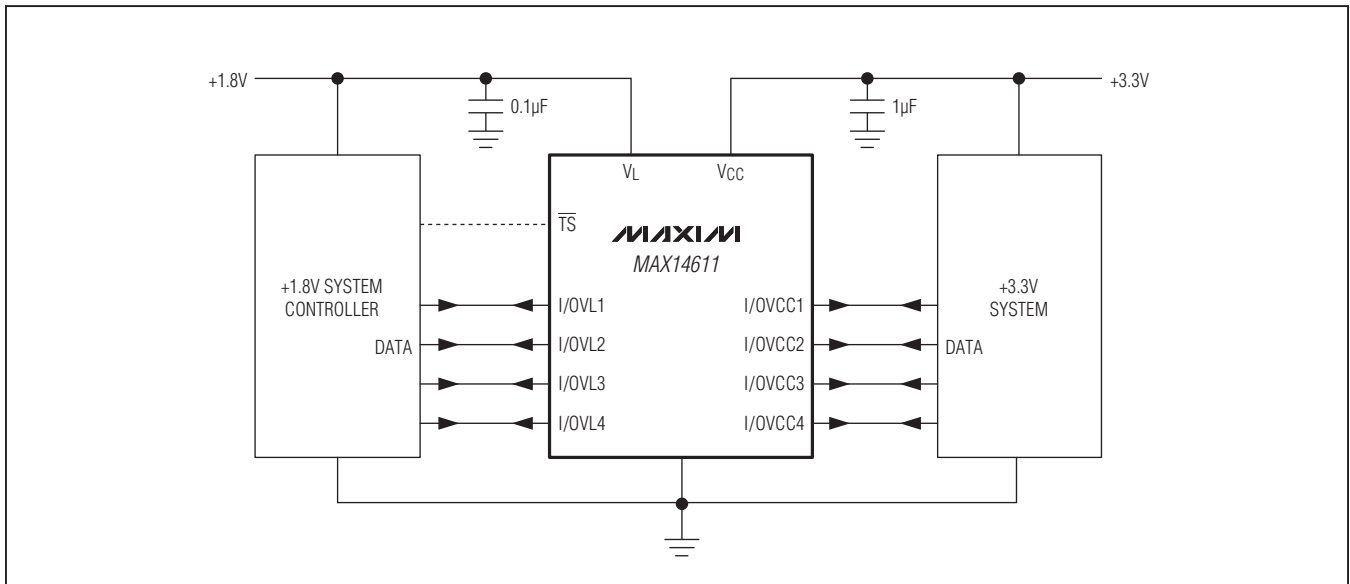

Figure 5. Open-Drain Operation

Applications Circuit



MAX14611

Quad Bidirectional Low-Voltage Logic-Level Translator

Ordering Information

PART	TEMP RANGE	PIN-PACKAGE
MAX14611ETD+	-40°C to +85°C	14 TDFN-EP*
MAX14611EUD+**	-40°C to +85°C	14 TSSOP

+Denotes a lead(Pb)-free/RoHS-compliant package.

*EP = Exposed pad.

**Future product—contact factory for availability.

Chip Information

PROCESS: BiCMOS

Package Information

For the latest package outline information and land patterns (footprints), go to www.maxim-ic.com/packages. Note that a "+", "#", or "-" in the package code indicates RoHS status only. Package drawings may show a different suffix character, but the drawing pertains to the package regardless of RoHS status.

PACKAGE TYPE	PACKAGE CODE	OUTLINE NO.	LAND PATTERN NO.
14 TDFN-EP	T1433+2	21-0137	90-0063
14 TSSOP	U14+1	21-0066	90-0113

MAX14611

Quad Bidirectional Low-Voltage Logic-Level Translator

Revision History

REVISION NUMBER	REVISION DATE	DESCRIPTION	PAGES CHANGED
0	4/12	Initial release	—

Maxim cannot assume responsibility for use of any circuitry other than circuitry entirely embodied in a Maxim product. No circuit patent licenses are implied. Maxim reserves the right to change the circuitry and specifications without notice at any time. The parametric values (min and max limits) shown in the Electrical Characteristics table are guaranteed. Other parametric values quoted in this data sheet are provided for guidance.

Maxim Integrated Products, 120 San Gabriel Drive, Sunnyvale, CA 94086 408-737-7600 _____ 15