



Chipsmall Limited consists of a professional team with an average of over 10 year of expertise in the distribution of electronic components. Based in Hongkong, we have already established firm and mutual-benefit business relationships with customers from,Europe,America and south Asia,supplying obsolete and hard-to-find components to meet their specific needs.

With the principle of “Quality Parts,Customers Priority,Honest Operation,and Considerate Service”,our business mainly focus on the distribution of electronic components. Line cards we deal with include Microchip,ALPS,ROHM,Xilinx,Pulse,ON,Everlight and Freescale. Main products comprise IC,Modules,Potentiometer,IC Socket,Relay,Connector.Our parts cover such applications as commercial,industrial, and automotives areas.

We are looking forward to setting up business relationship with you and hope to provide you with the best service and solution. Let us make a better world for our industry!



Contact us

Tel: +86-755-8981 8866 Fax: +86-755-8427 6832

Email & Skype: info@chipsmall.com Web: www.chipsmall.com

Address: A1208, Overseas Decoration Building, #122 Zhenhua RD., Futian, Shenzhen, China



76V, 300mW Boost Converter and Current Monitor for APD Bias Applications

General Description

The MAX15059 constant-frequency pulse-width modulating (PWM) step-up DC-DC converter features an internal switch and a high-side current monitor with high-speed adjustable current limiting. This device is capable of generating output voltages up to 76V (300mW for the MAX15059A and 200mW for the MAX15059B) and provides current monitoring up to 4mA. The MAX15059 operates from 2.8V to 5.5V.

The constant-frequency (400kHz) current-mode PWM architecture provides low-noise-output voltage that is easy to filter. A high-voltage internal power MOSFET allows this device to boost output voltages up to 76V. Internal soft-start circuitry limits the input current when the boost converter starts. The MAX15059 features a shutdown mode to save power.

The MAX15059 includes a current monitor with more than three decades of dynamic range and monitors current ranging from 500nA to 4mA with high accuracy. Resistor-adjustable current limiting protects the APD from optical power transients. A clamp diode protects the monitor's output from overvoltage conditions. Other protection features include cycle-by-cycle current limiting of the boost converter switch, undervoltage lockout (UVLO), and thermal shutdown if the die temperature reaches +125°C.

The MAX15059 is available in a thermally enhanced, lead-free, 16-pin TQFN-EP package and operates over the -40°C to +125°C temperature range.

Typical Operating Circuit

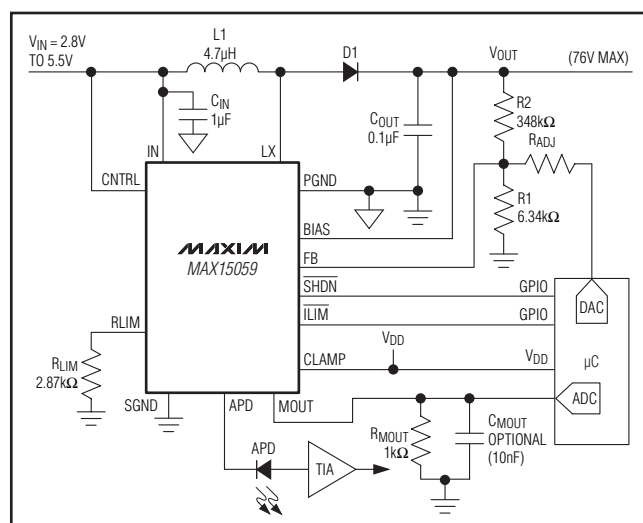

Features

- ◆ Input Voltage Range: +2.8V to +5.5V
- ◆ Wide Output-Voltage Range from (VIN + 5V) to 76V
- ◆ Internal 1Ω (typ) 80V MOSFET
- ◆ Boost Converter Output Power: 300mW
- ◆ 200mW Version Available for Smaller Inductor
- ◆ Accurate ±5% (1:1 and 5:1) High-Side Current Monitor
- ◆ Resistor-Adjustable Ultra-Fast APD Current Limit (1µs Response Time)
- ◆ Open-Drain Current-Limit Indicator Flag
- ◆ 400kHz Fixed-Switching Frequency
- ◆ Constant PWM Frequency Provides Easy Filtering in Low-Noise Applications
- ◆ Internal Soft-Start
- ◆ 2µA (max) Shutdown Current
- ◆ -40°C to +125°C Temperature Range
- ◆ Small, Thermally Enhanced, 3mm x 3mm, Lead-Free, 16-Pin TQFN-EP Package

Applications

Avalanche Photodiode Biasing and Monitoring
PIN Diode Bias Supply
Low-Noise Varactor Diode Bias Supply
FBON Modules
GPON Modules

Ordering Information

| PART | MAXIMUM POWER (mW) | IAPD: IMOUT | PIN-PACKAGE |
|---------------|--------------------|-------------|-------------|
| MAX15059AETE+ | 300 | 1:1 | 16 TQFN-EP* |
| MAX15059BETE+ | 200 | 5:1 | 16 TQFN-EP* |
| MAX15059AATE+ | 300 | 1:1 | 16 TQFN-EP* |
| MAX15059BATE+ | 200 | 5:1 | 16 TQFN-EP* |

Note: The MAX15059AATE+ and MAX15059BATE+ operate over the -40°C to +125°C temperature range. The MAX15059EATE+ and MAX15059BETE+ operate over the -40°C to +85°C temperature range.

+ Denotes a lead(Pb)-free/RoHS-compliant package.

*EP = Exposed pad.

76V, 300mW Boost Converter and Current Monitor for APD Bias Applications

ABSOLUTE MAXIMUM RATINGS

IN, $\overline{\text{SHDN}}$, FB, $\overline{\text{ILIM}}$, RLIM, CNTRL to SGND.....-0.3V to +6V
 LX to PGND.....-0.3V to +80V
 BIAS to SGND.....-0.3V to +79V
 APD, CLAMP to SGND.....-0.3V to (VBIAS + 0.3V)
 PGND to SGND.....-0.3V to +0.3V
 MOUT to SGND.....-0.3V to (VCLAMP + 0.3V)
 Continuous Power Dissipation (T_A = +70°C)
 16-Pin TQFN-EP (derate 20.8mW/°C above +70°C).... 1666.7mW

Operating Temperature Range
 MAX15059AETE, MAX15059BETE.....-40°C to +85°C
 MAX15059AATE, MAX15059BATE.....-40°C to +125°C
 Operating Temperature Range.....-40°C to +85°C
 Maximum Junction Temperature.....+150°C
 Storage Temperature Range.....-65°C to +150°C
 Lead Temperature (soldering, 10s).....+300°C
 Soldering Temperature (reflow).....+260°C

PACKAGE THERMAL CHARACTERISTICS (Note 1)

TQFN

Junction-to-Ambient Thermal Resistance (θ_{JA}).....48°C/W
 Junction-to-Case Thermal Resistance (θ_{JC}).....7°C/W

Note 1: Package thermal resistances were obtained using the method described in JEDEC specification JESD51-7, using a four-layer board. For detailed information on package thermal considerations, refer to www.maxim-ic.com/thermal-tutorial.

Stresses beyond those listed under "Absolute Maximum Ratings" may cause permanent damage to the device. These are stress ratings only, and functional operation of the device at these or any other conditions beyond those indicated in the operational sections of the specifications is not implied. Exposure to absolute maximum rating conditions for extended periods may affect device reliability.

ELECTRICAL CHARACTERISTICS

(V_{IN} = V $\overline{\text{SHDN}}$ = V_{CNTRL} = 3.3V, C_{IN} = 1μF, V_{PGND} = V_{SGND} = 0V, V_{BIAS} = 40V, LX = APD = CLAMP = $\overline{\text{ILIM}}$ = unconnected, V_{MOUT} = 0V, T_A = -40°C to +85°C for the MAX15059AETE+ and MAX15059BETE+ and T_A = -40°C to +125°C for the MAX15059AATE+ and MAX15059BATE+, unless otherwise noted. Typical values are at T_A = +25°C.) (Note 2)

| PARAMETER | SYMBOL | CONDITIONS | MIN | TYP | MAX | UNITS | |
|---------------------------------|------------------------|--|---------------------------------|-------|-------|-------|----|
| INPUT SUPPLY | | | | | | | |
| Supply Voltage Range | V _{IN} | | 2.8 | | 5.5 | V | |
| Supply Current | I _{SUPPLY} | V _{FB} = 1.4V, no switching | T _A = -40°C to +85°C | | 0.6 | 1.2 | mA |
| | | | T _A = +125°C | | | 1.35 | |
| Undervoltage-Lockout Threshold | V _{UVLO} | V _{IN} rising | 2.475 | 2.6 | 2.775 | V | |
| Undervoltage-Lockout Hysteresis | V _{UVLO_HYS} | | | 200 | | mV | |
| Shutdown Current | I _{SHDN} | V $\overline{\text{SHDN}}$ = 0V | | 0.003 | 2 | μA | |
| Shutdown BIAS Current | I _{BIAS_SHDN} | V _{BIAS} = 3.3V, V $\overline{\text{SHDN}}$ = 0V | | 9 | 20 | μA | |
| BOOST CONVERTER | | | | | | | |
| Output-Voltage Adjustment Range | | | V _{IN} + 5 | | 76 | V | |
| Switching Frequency | f _{SW} | V _{IN} = 5V | 380 | 400 | 420 | kHz | |
| Maximum Duty Cycle | D _{CLK} | V _{IN} = 2.8V | 88 | 90 | 92 | % | |
| FB Set-Point Voltage | V _{FB_SET} | | 1.205 | 1.23 | 1.255 | V | |
| FB Input-Bias Current | I _{FB} | V _{FB} = V _{FB_SET} , T _A = +25°C | 100 | | 500 | nA | |
| Internal Switch On-Resistance | R _{ON} | I _{LX} = 100mA, V _{IN} = 2.8V | T _A = -40°C to +85°C | | 1 | 2 | Ω |
| | | | T _A = +125°C | | | 2.25 | |
| Peak Switch Current Limit | I _{LIM_LX} | MAX15059A | 1.1 | 1.2 | 1.3 | A | |
| | | MAX15059B | 0.825 | 0.9 | 0.975 | | |
| Peak Current-Limit Response | | | | 100 | | ns | |

76V, 300mW Boost Converter and Current Monitor for APD Bias Applications

MAX15059

ELECTRICAL CHARACTERISTICS (continued)

($V_{IN} = V_{SHDN} = V_{CNTRL} = 3.3V$, $C_{IN} = 1\mu F$, $V_{PGND} = V_{SGND} = 0V$, $V_{BIAS} = 40V$, $LX = APD = CLAMP = \overline{ILIM} = \text{unconnected}$, $V_{MOUT} = 0V$, $T_A = -40^\circ C$ to $+85^\circ C$ for the MAX15059AETE+ and MAX15059BETE+ and $T_A = -40^\circ C$ to $+125^\circ C$ for the MAX15059AATE+ and MAX15059BATE+, unless otherwise noted. Typical values are at $T_A = +25^\circ C$.) (Note 2)

| PARAMETER | SYMBOL | CONDITIONS | MIN | TYP | MAX | UNITS | |
|-------------------------------------|------------------------|---|--------------------------------------|-------|------|-----------|-------|
| LX Leakage Current | | $V_{LX} = 76V$, $T_A = +25^\circ C$ | | | 1 | μA | |
| Line Regulation | | $2.8V \leq V_{IN} \leq 5.5V$, $I_{LOAD} = 4.5mA$ | | 0.01 | | % | |
| Load Regulation | | $0 \leq I_{LOAD} \leq 4.5mA$ | | 0.05 | | % | |
| Soft-Start Duration | | | | 8 | | ms | |
| Soft-Start Steps | | | | 32 | | Steps | |
| CONTROL INPUT (CNTRL) | | | | | | | |
| Maximum Control Input Voltage Range | | FB set point is controlled to V_{CNTRL} | | 1.2 | | V | |
| CNTRL-to-REF Transition Threshold | | $V_{FB} = V_{REF}$ above this voltage | | 1.3 | | V | |
| CNTRL Input-Bias Current | | $V_{CNTRL} = V_{FB_SET}$, $T_A = +25^\circ C$ | | | 500 | nA | |
| CURRENT MONITOR | | | | | | | |
| Bias Voltage Range | V_{BIAS} | | 10 | | 76 | V | |
| Bias Quiescent Current | I_{BIAS} | $I_{APD} = 500nA$ | MAX15059A | 150 | 250 | μA | |
| | | | MAX15059B | 150 | 250 | | |
| | | $I_{APD} = 2mA$ | MAX15059A | 4 | 6 | mA | |
| | | | MAX15059B | 3 | 4 | | |
| Voltage Drop | V_{DROP} | $I_{APD} = 2mA$, $V_{DROP} = V_{BIAS} - V_{APD}$ | | 2.7 | 3.5 | V | |
| Dynamic Output Resistance at MOUT | R_{MOUT} | $R_{MOUT} = \Delta V_{MOUT} / \Delta I_{MOUT}$, $I_{APD} = 2.5mA$ | | 5 | | $G\Omega$ | |
| APD Current-Step Response | | Step load on $I_{APD} = 20\mu A$ to 1mA | | 25 | | ns | |
| MOUT Output Leakage | | APD is unconnected, $T_A = +25^\circ C$ | | 1 | 300 | nA | |
| Output Clamp Voltage | $V_{MOUT} - V_{CLAMP}$ | Forward diode current = 500 μA | 0.4 | 0.7 | 0.95 | V | |
| MOUT Voltage Range | V_{MOUT} | $10V \leq V_{BIAS} \leq 76V$, $0 \leq I_{APD} \leq 1mA$, CLAMP is unconnected | $V_{BIAS} - 2.7$ | | | V | |
| Current Gain | I_{MOUT} / I_{APD} | $I_{APD} = 500nA$ | MAX15059A | 0.95 | 1 | 1.1 | mA/mA |
| | | | MAX15059B | 0.19 | 0.2 | 0.22 | |
| | | $I_{APD} = 2mA$ | MAX15059A | 0.965 | 1 | 1.035 | |
| | | | MAX15059B | 0.193 | 0.2 | 0.207 | |
| Power-Supply Rejection Ratio | PSRR | $(\Delta I_{MOUT} / I_{MOUT}) / \Delta V_{BIAS}$, $V_{BIAS} = 10V$ to 76V and $I_{APD} = 5\mu A$ to 1mA (Note 3) | MAX15059A | 20 | 300 | 610 | ppm/V |
| | | | MAX15059B | 20 | 300 | 700 | |
| APD Input Current Limit | I_{LIM_APD} | $T_A = -40^\circ C$ to $+85^\circ C$ | 4 | 4.6 | 5.2 | mA | |
| | | $T_A = +125^\circ C$ | 3.85 | | 5.2 | | |
| Current-Limit Adjustment Range | | $9.75k\Omega \geq R_{LIM} \geq 0$ | $T_A = -40^\circ C$ to $+85^\circ C$ | 0.9 | | 5.2 | mA |
| | | | $T_A = +125^\circ C$ | 0.89 | | 5.2 | |
| Power-Up Settling Time | t_S | I_{MOUT} settles to within 0.1%, 10nF connected from APD to ground | $I_{APD} = 500nA$ | | 7.5 | ms | |
| | | | $I_{APD} = 2.5mA$ | | 90 | μs | |

76V, 300mW Boost Converter and Current Monitor for APD Bias Applications

ELECTRICAL CHARACTERISTICS (continued)

($V_{IN} = \overline{V_{SHDN}} = V_{CNTRL} = 3.3V$. $C_{IN} = 1\mu F$, $V_{PGND} = V_{SGND} = 0V$, $V_{BIAS} = 40V$. $LX = APD = CLAMP = \overline{ILIM} =$ unconnected, $V_{MOUT} = 0V$, $T_A = -40^\circ C$ to $+85^\circ C$ for the MAX15059AETE+ and MAX15059BETE+ and $T_A = -40^\circ C$ to $+125^\circ C$ for the MAX15059AATE+ and MAX15059BATE+, unless otherwise noted. Typical values are at $T_A = +25^\circ C$.) (Note 2)

| PARAMETER | SYMBOL | CONDITIONS | MIN | TYP | MAX | UNITS |
|--|----------|---------------------|-----|------|-----|------------|
| LOGIC I/O | | | | | | |
| \overline{SHDN} Input Voltage Low | V_{IL} | | | | 0.8 | V |
| \overline{SHDN} Input Voltage High | V_{IH} | | 2.1 | | | V |
| \overline{ILIM} Output Voltage Low | V_{OL} | $I_{LIM} = 2mA$ | | | 0.1 | V |
| \overline{ILIM} Output Leakage Current | I_{OH} | $T_A = +25^\circ C$ | | | 1 | μA |
| THERMAL PROTECTION | | | | | | |
| Thermal-Shutdown Temperature | | Temperature rising | | +150 | | $^\circ C$ |
| Thermal-Shutdown Hysteresis | | | | 15 | | $^\circ C$ |

Note 2: All MIN/MAX parameters are tested at $T_A = +25^\circ C$. Limits overtemperature are guaranteed by design.

Note 3: Guaranteed by design and not production tested.

Typical Operating Characteristics

($V_{IN} = 3.3V$, $V_{OUT} = 70V$, $T_A = +25^\circ C$, unless otherwise noted.)

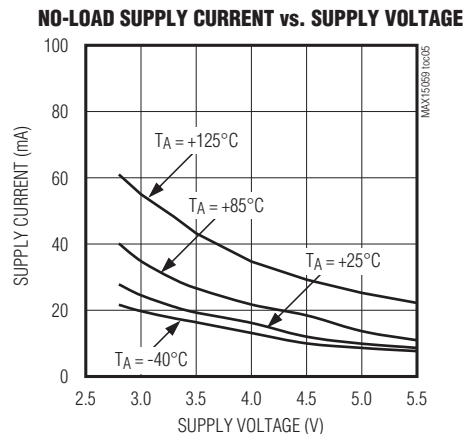
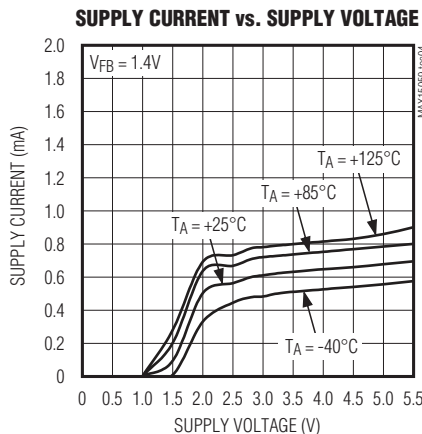
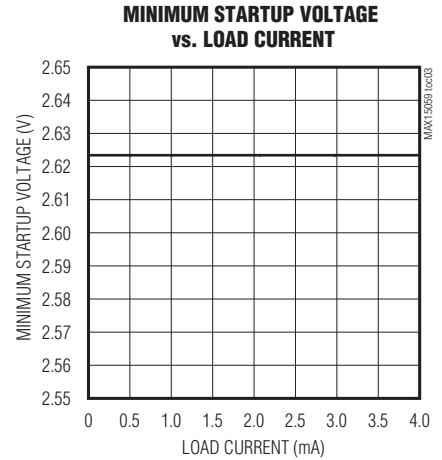
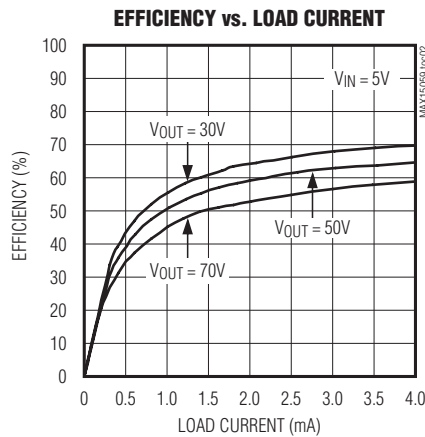
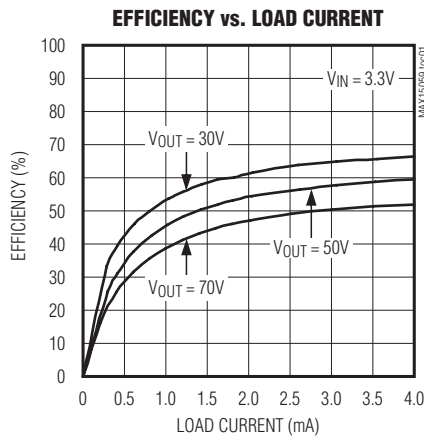

76V, 300mW Boost Converter and Current Monitor for APD Bias Applications

Typical Operating Characteristics (continued)

($V_{IN} = 3.3V$, $V_{OUT} = 70V$, $T_A = +25^{\circ}C$, unless otherwise noted.)

MAX15059

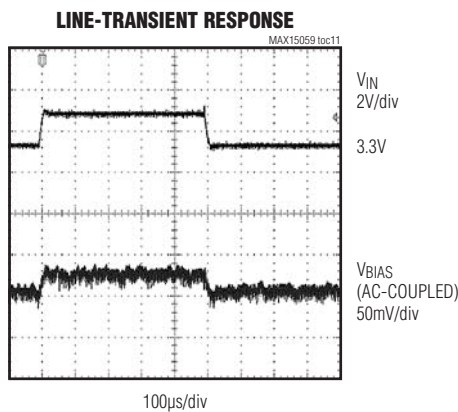
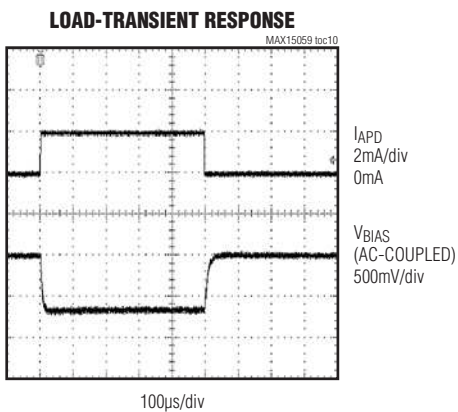
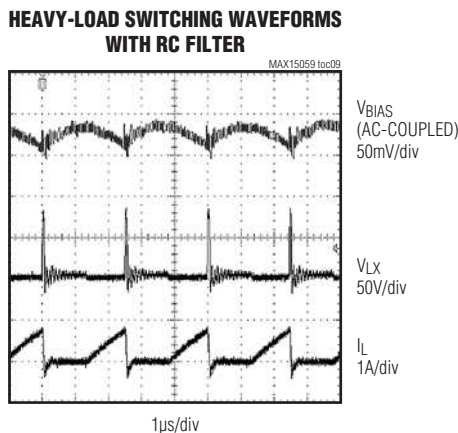
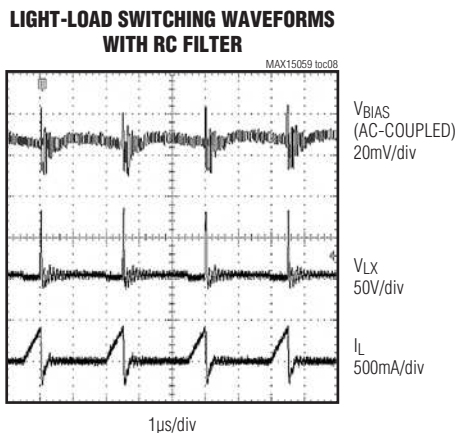
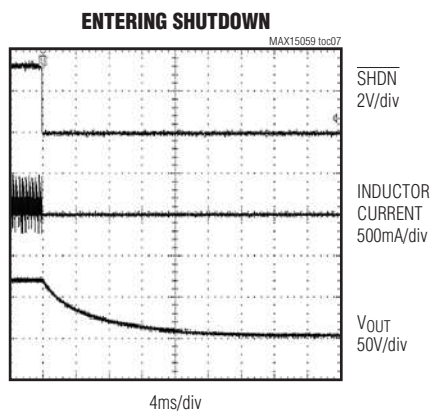
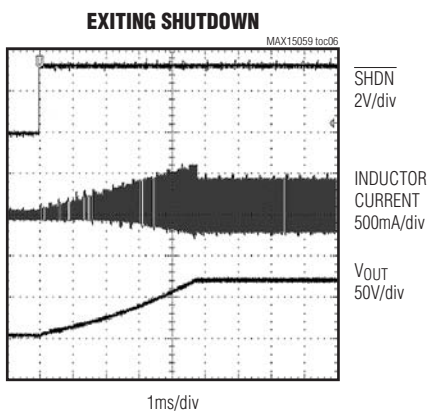

76V, 300mW Boost Converter and Current Monitor for APD Bias Applications

Typical Operating Characteristics (continued)

($V_{IN} = 3.3V$, $V_{OUT} = 70V$, $T_A = +25^\circ C$, unless otherwise noted.)

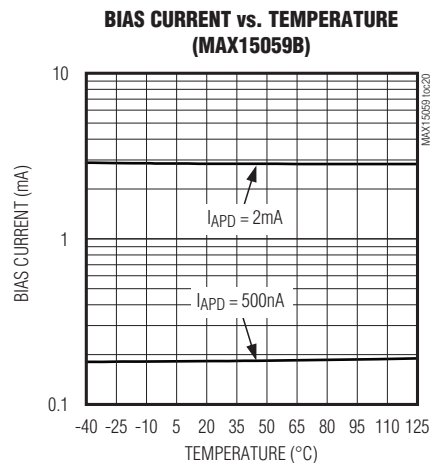
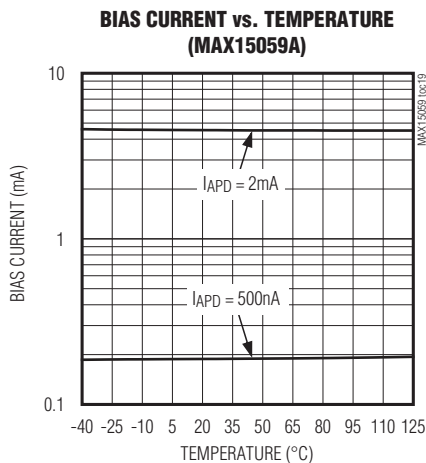
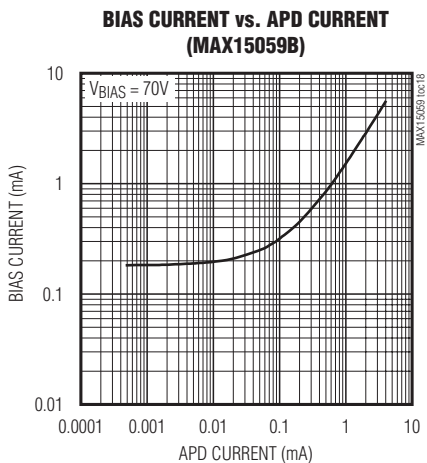
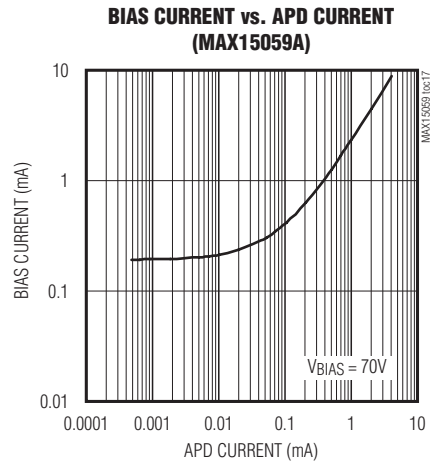
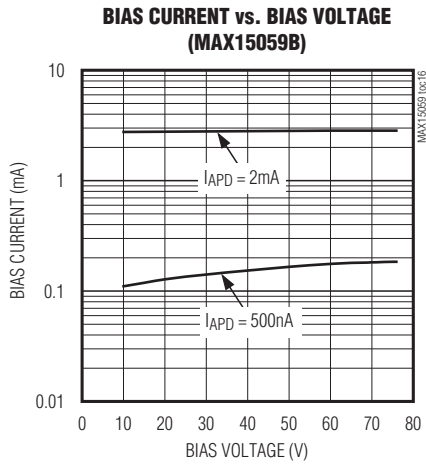
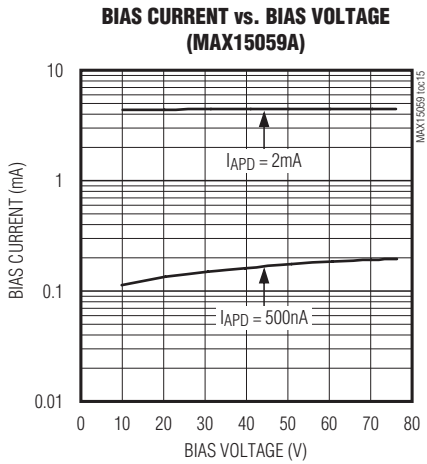
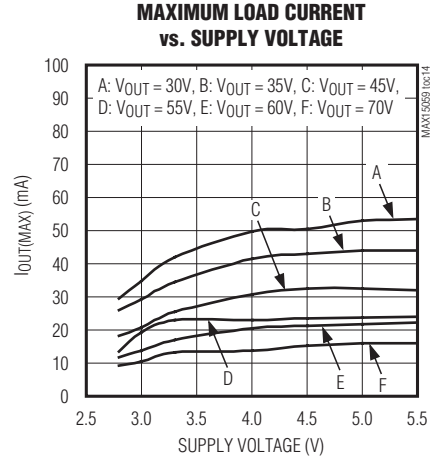
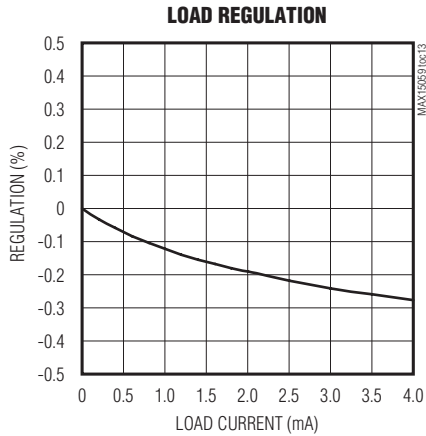
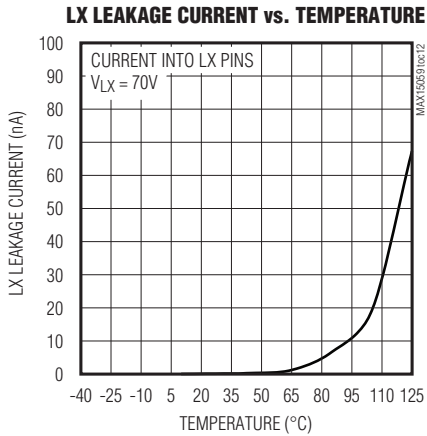

76V, 300mW Boost Converter and Current Monitor for APD Bias Applications

Typical Operating Characteristics (continued)

($V_{IN} = 3.3V$, $V_{OUT} = 70V$, $T_A = +25^\circ C$, unless otherwise noted.)

**GAIN ERROR vs. APD CURRENT
(MAX15059A)**

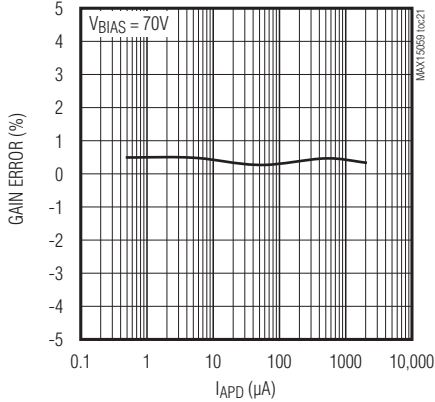

**GAIN ERROR vs. APD CURRENT
(MAX15059B)**

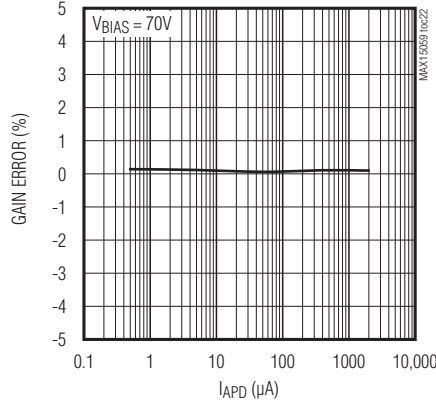

**GAIN ERROR vs. TEMPERATURE
(MAX15059A)**

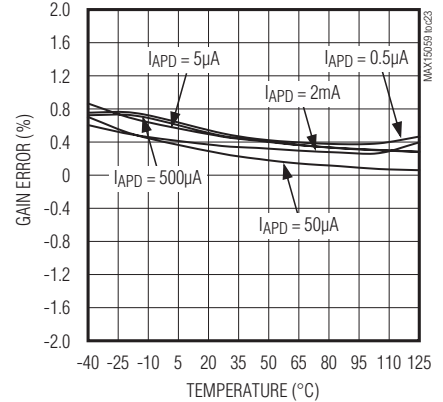

**GAIN ERROR vs. TEMPERATURE
(MAX15059B)**

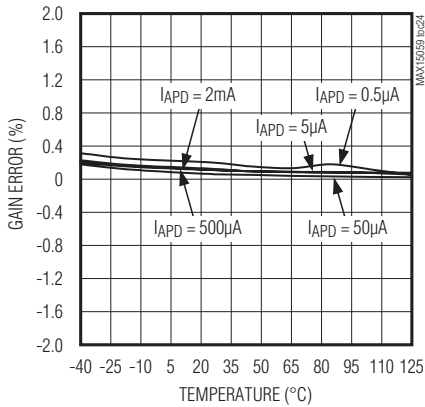

**GAIN ERROR vs. BIAS VOLTAGE
(MAX15059A)**

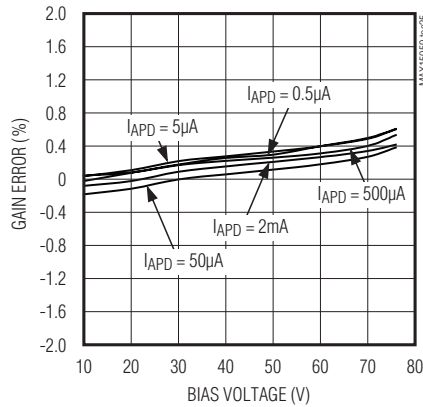

**GAIN ERROR vs. BIAS VOLTAGE
(MAX15059B)**

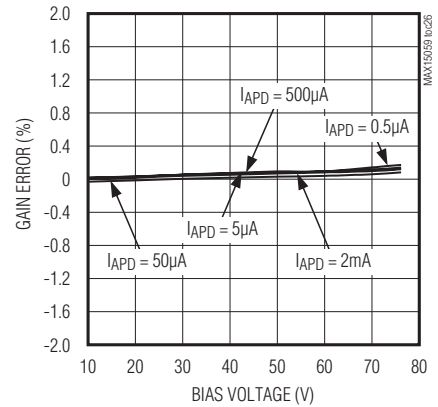

**APD TRANSIENT RESPONSE
(MAX15059A)**

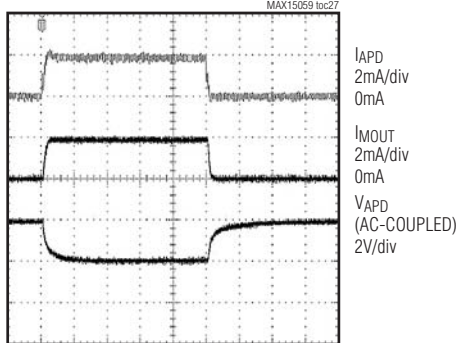

**APD TRANSIENT RESPONSE
(MAX15059A)**

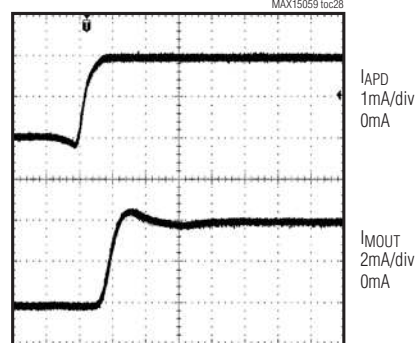

76V, 300mW Boost Converter and Current Monitor for APD Bias Applications

Typical Operating Characteristics (continued)

($V_{IN} = 3.3V$, $V_{OUT} = 70V$, $T_A = +25^\circ C$, unless otherwise noted.)

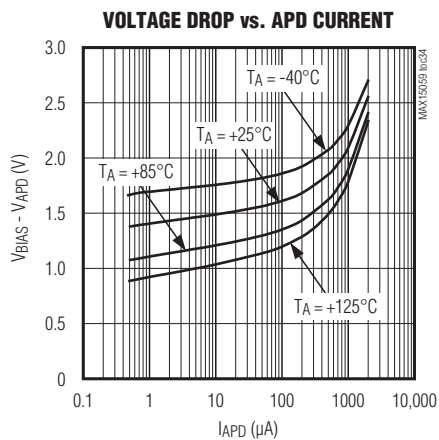
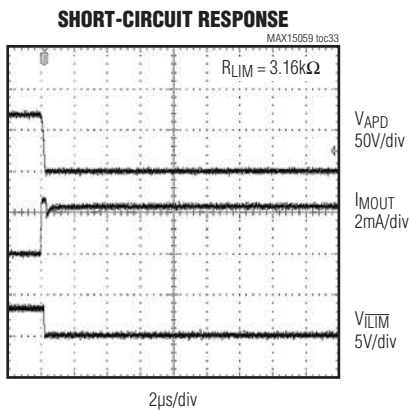
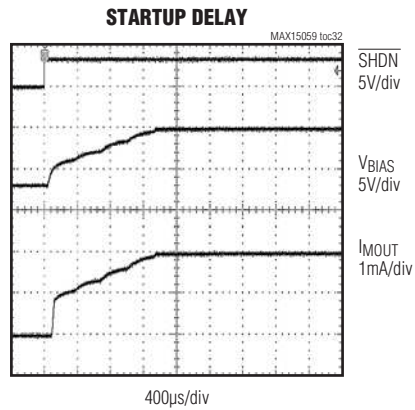
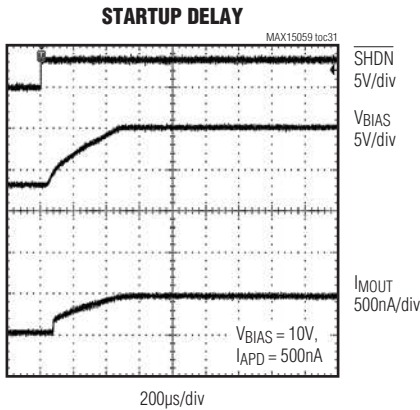
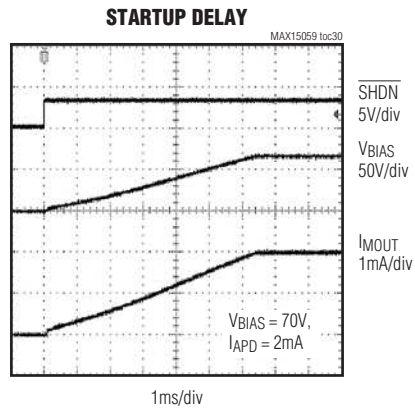
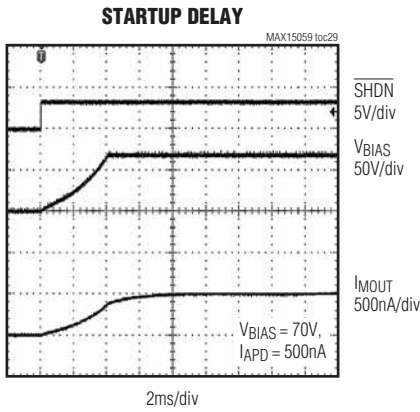

76V, 300mW Boost Converter and Current Monitor for APD Bias Applications

Typical Operating Characteristics (continued)

(VIN = 3.3V, VOUT = 70V, TA = +25°C, unless otherwise noted.)

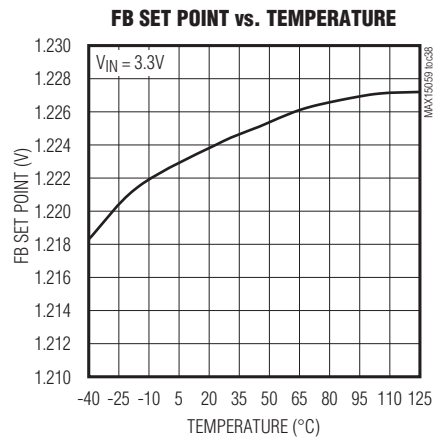
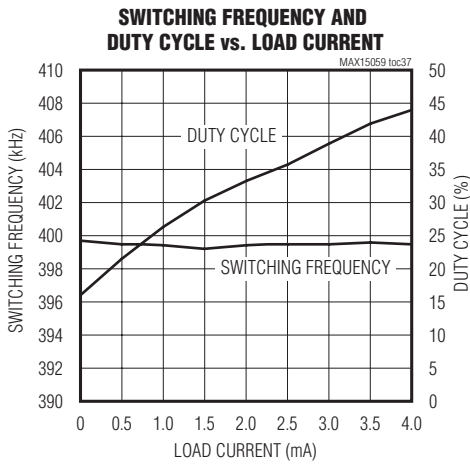
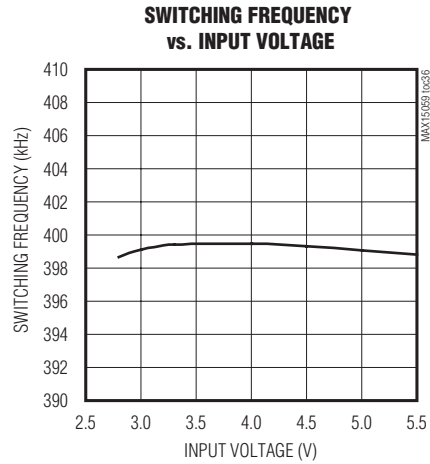
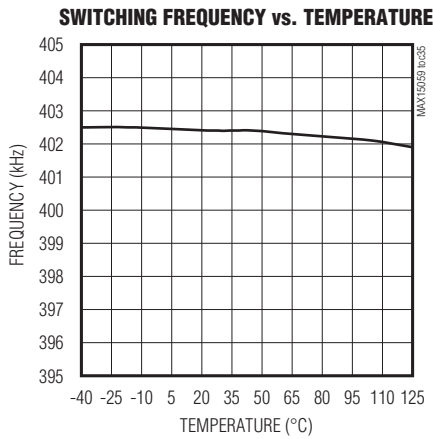

APD OUTPUT RIPPLE VOLTAGE
(0.1μF FROM APD TO GROUND, VBIAS = 70V, IAPD = 1mA)

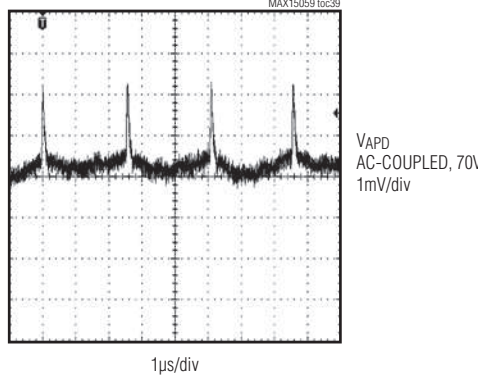

76V, 300mW Boost Converter and Current Monitor for APD Bias Applications

Pin Configuration

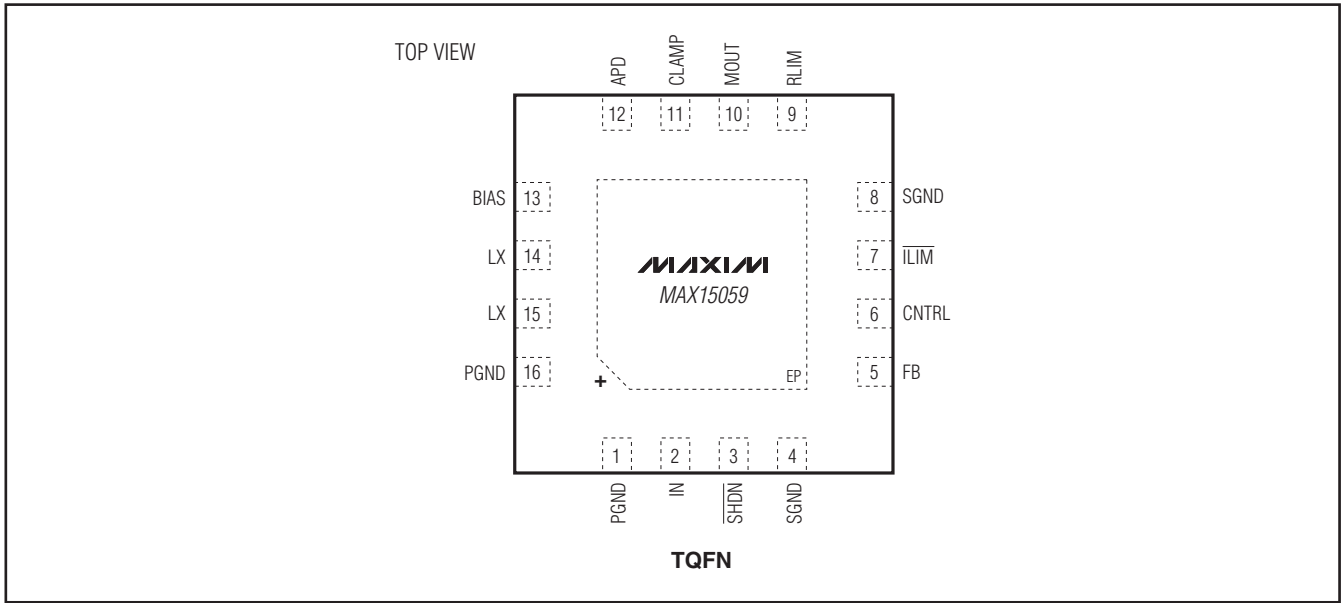

Pin Description

| PIN | NAME | FUNCTION |
|-------|--------------------------|--|
| 1, 16 | PGND | Power Ground. Connect the negative terminals of the input and output capacitors to PGND. Connect PGND externally to SGND at a single point, typically at the return terminal of the output capacitor. |
| 2 | IN | Input-Supply Voltage. Bypass IN to PGND with a ceramic capacitor of 1 μ F minimum value. |
| 3 | $\overline{\text{SHDN}}$ | Active-Low Shutdown Control Input. Apply a logic-low voltage to $\overline{\text{SHDN}}$ to shut down the device. Connect $\overline{\text{SHDN}}$ to IN for normal operation. Ensure that $V_{\overline{\text{SHDN}}}$ is not greater than the input voltage, V_{IN} . $\overline{\text{SHDN}}$ is internally pulled low. The converter is disabled when SHDN is left unconnected. |
| 4, 8 | SGND | Signal Ground. Connect directly to the local ground plane. Connect SGND to PGND at a single point, typically near the return terminal of the output capacitor. |
| 5 | FB | Feedback Regulation Input. Connect FB to the center tap of a resistive voltage-divider from the boost output to SGND to set the output voltage. The FB voltage regulates to 1.23V (typ) when V_{CNTRL} is above 1.3V (typ) and to V_{CNTRL} when V_{CNTRL} is below 1.2V (typ). |
| 6 | CNTRL | Control Input for Boost Converter Output-Voltage Programmability. CNTRL allows the feedback set-point voltage to be set externally by CNTRL when V_{CNTRL} is less than 1.2V. Pull CNTRL above 1.3V (typ) to use the internal 1.23V (typ) feedback set-point voltage. |
| 7 | $\overline{\text{ILIM}}$ | Open-Drain Current-Limit Indicator. $\overline{\text{ILIM}}$ asserts low when the APD current limit has been exceeded. |
| 9 | RLIM | Current-Limit Resistor Connection. Connect a resistor from RLIM to SGND to program the APD current-limit threshold. When RLIM is connected to SGND, the current limit is set to 4.6mA. |
| 10 | MOUT | Current-Monitor Output. For the MAX15059A, MOUT sources a current equal to I_{APD} . For the MAX15059B, MOUT sources a current equal to 1/5 of I_{APD} . |
| 11 | CLAMP | Clamp Voltage Input. CLAMP is the external potential used for voltage clamping of MOUT. |

76V, 300mW Boost Converter and Current Monitor for APD Bias Applications

MAX15059

Pin Description (continued)

| PIN | NAME | FUNCTION |
|--------|------|---|
| 12 | APD | Reference Current Output. APD provides the source current to the cathode of the photodiode. |
| 13 | BIAS | Bias-Voltage Input. Connect BIAS to the boost converter output (VOUT) either directly or through a lowpass filter for ripple attenuation. BIAS provides the voltage bias for the current monitor and is the current source for APD. |
| 14, 15 | LX | Drain of Internal 80V n-Channel DMOS. Connect inductor to LX. Minimize the trace area at LX to reduce switching-noise emission. |
| — | EP | Exposed Pad. Connect to a large copper plane at the SGND and PGND potential to improve thermal dissipation. Do not use as the only ground connection. |

Functional Diagram

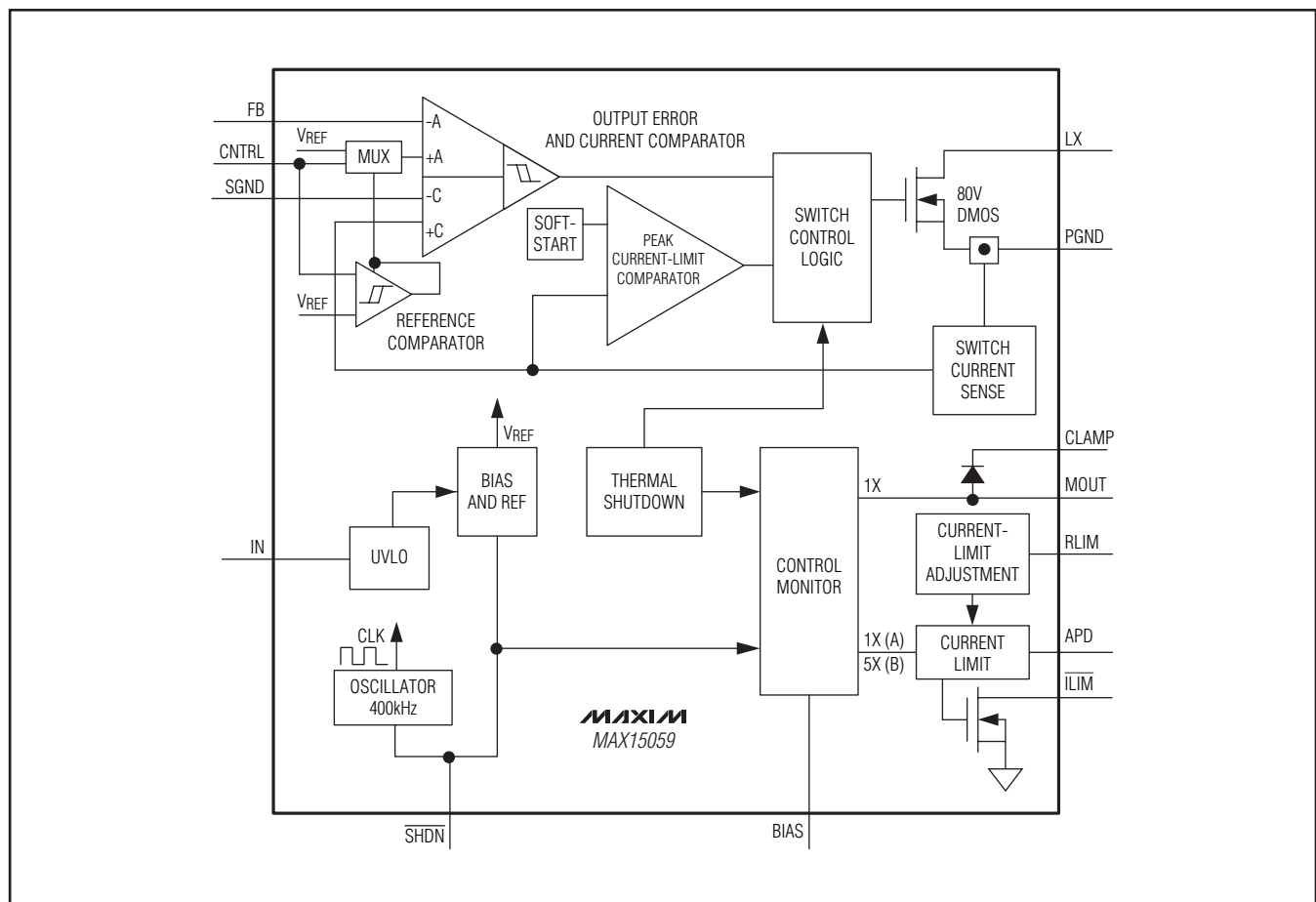

76V, 300mW Boost Converter and Current Monitor for APD Bias Applications

Detailed Description

The MAX15059 constant-frequency, current-mode, PWM boost converters are intended for low-voltage systems that require a locally generated high voltage. This device is capable of generating a low-noise, high output voltage required for PIN and varactor diode biasing. The MAX15059 operates from +2.8V to +5.5V.

The MAX15059 operates in discontinuous mode in order to reduce the switching noise caused by reverse recovery charge of the rectifier diode and eliminates the need for external compensation components. Other continuous-mode boost converters generate large voltage spikes at the output when the LX switch turns on because there is a conduction path between the output, diode, and switch to ground during the time needed for the diode to turn off and reverse its bias voltage. To reduce the output noise even further, the LX switch turns off by taking 10ns typically to transition from on to off. As a consequence, the positive slew rate of the LX node is reduced and the current from the inductor does not “force” the output voltage as hard as would be the case if the LX switch were to turn off faster.

The constant-frequency (400kHz) PWM architecture generates an output voltage ripple that is easy to filter. An 80V lateral DMOS device used as the internal power switch is ideal for boost converters with output voltages up to 76V. The MAX15059 can also be used in other topologies where the PWM switch is grounded, like SEPIC and flyback converters.

The MAX15059 includes a versatile current monitor intended for monitoring the APD, PIN, or varactor diode DC current in fiber and other applications. The MAX15059 features more than three decades of dynamic current ranging from 500nA to 4mA and provides an output current accurately proportional to the APD current at MOUT. MOUT output accuracy is $\pm 10\%$ from 500nA to 1mA and $\pm 5\%$ from 1mA to 2mA.

The MAX15059 also features a shutdown logic input to disable the device and reduce its standby current to 2 μ A (max).

Fixed-Frequency PWM Controller

The heart of the MAX15059 current-mode PWM controller is a BiCMOS multi-input comparator that simultaneously processes the output-error signal and switch current signal. The main PWM comparator uses direct summing, lacking a traditional error amplifier and its associated phase shift. The direct summing configura-

tion approaches ideal cycle-by-cycle control over the output voltage since there is no conventional error amplifier in the feedback path.

This device operates in PWM mode using a fixed-frequency, current-mode operation. The current-mode frequency loop regulates the peak inductor current as a function of the output-voltage error signal.

The current-mode PWM controller is intended for DCM operation. No internal slope compensation is added to the current signal.

Current Limit

The current limit of the current monitor is programmable from 1mA to 4.6mA (typ). Connect RLIM to SGND to get a default current-limit threshold of 4.6mA or connect a resistor from RLIM to SGND to program the current-limit threshold below the default setting of 4.6mA. Calculate the value of the external resistor, RLIM, for a given current limit, ILIM, using the following equation:

$$R_{LIM}(k\Omega) = \left[\left(\frac{1.23V}{I_{LIM}(mA)} \right) \times 10 - 2.67(k\Omega) \right]$$

Clamping the Monitor Output Voltage (MOUT)

CLAMP provides a means for diode clamping the voltage at MOUT; thus, VMOUT is limited to (VCLAMP + 0.6V). CLAMP can be connected to either an external supply or BIAS. Leave CLAMP unconnected if voltage clamping is not required.

Shutdown

The MAX15059 features an active-low shutdown input (\overline{SHDN}). Pull \overline{SHDN} low or leave it unconnected to enter shutdown. During shutdown, the supply current drops to 2 μ A (max). The output remains connected to the input through the inductor and output rectifier, holding the output voltage to one diode drop below IN when the MAX15059 is in shutdown. Connect \overline{SHDN} to IN for always-on operation.

Adjusting the Feedback Set-Point/Reference Voltage

Apply a voltage to the CNTRL input to set the feedback set-point reference voltage, VREF (see the *Functional Diagram*). For VCNTRL > 1.3V, the internal 1.23V (typ) reference voltage is used as the feedback set point and for VCNTRL < 1.2V, the CNTRL voltage is used as the reference voltage (VFB set equal to VCNTRL).

76V, 300mW Boost Converter and Current Monitor for APD Bias Applications

Design Procedure

Setting the Output Voltage

Set the MAX15059 output voltage by connecting a resistive divider from the output to FB to SGND (Figure 1). Select R_1 (FB to SGND resistor) between $5k\Omega$ and $10k\Omega$. Calculate R_2 (V_{OUT} to FB resistor) using the following equation:

$$R_2 = R_1 \left[\left(\frac{V_{OUT}}{V_{REF}} \right) - 1 \right]$$

where V_{OUT} can range from ($V_{IN} + 5V$) to 76V. Apply a voltage to the CNTRL input to set the feedback set-point reference voltage, V_{REF} (see the *Functional Diagram*). For $V_{CNTRL} > 1.3V$, the internal 1.23V (typ) reference voltage is used as the feedback set point and for $V_{CNTRL} < 1.2V$, $V_{REF} = V_{CNTRL}$. See the *Adjusting the Feedback Set-Point/Reference Voltage* section for more information on adjusting the feedback reference voltage, V_{REF} .

Determining Peak Inductor Current

If the boost converter remains in the discontinuous mode of operation, then the approximate peak inductor current, I_{LPEAK} (in A), is represented by the formula below:

$$I_{LPEAK} = \sqrt{\frac{2 \times t_S \times (V_{OUT} - V_{IN_MIN}) \times I_{OUT_MAX}}{\eta \times L}}$$

where t_S is the switching period in μs , V_{OUT} is the output voltage in volts, V_{IN_MIN} is the minimum input voltage in volts, I_{OUT_MAX} is the maximum output current in amps, L is the inductor value in μH , and η is the efficiency of the boost converter (see the *Typical Operating Characteristics*).

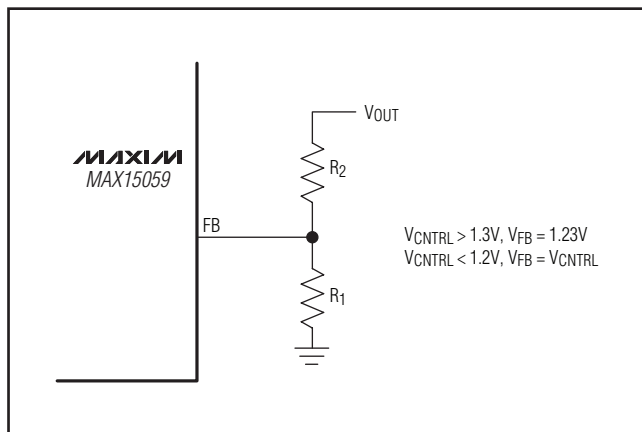

Figure 1. Adjustable Output Voltage

Determining the Inductor Value

Three key inductor parameters must be specified for operation with the MAX15059: inductance value (L), inductor saturation current (I_{SAT}), and DC resistance (DCR). In general, the inductor should have a saturation current rating greater than the maximum peak switch current-limit value ($I_{LIM_LX} = 1.3A$). DCR should be low for reasonable efficiency.

Use the following formula to calculate the lower bound of the inductor value at different output voltages and output currents. This is the minimum inductance value for discontinuous mode operation for supplying full 300mW of output power:

$$L_{MIN}[\mu H] = \frac{2 \times t_S \times I_{OUT} \times (V_{OUT} - V_{IN_MIN})}{\eta \times I_{LIM_LX}^2}$$

where V_{IN_MIN} , V_{OUT} (both in volts), and I_{OUT} (in amps) are typical values (so that efficiency is optimum for typical conditions), t_S (in μs) is the period, η is the efficiency, and I_{LIM_LX} is the peak switch current in amps (see the *Electrical Characteristics* table).

Calculate the optimum value of L ($L_{OPTIMUM}$) to ensure the full output power without reaching the boundary between continuous-conduction mode (CCM) and discontinuous-conduction mode (DCM) using the following formula:

$$L_{OPTIMUM}[\mu H] = \frac{L_{MAX}[\mu H]}{2.25}$$

where:

$$L_{MAX}[\mu H] = \frac{V_{IN_MIN}^2 (V_{OUT} - V_{IN_MIN}) \times t_S \times \eta}{2 \times I_{OUT} \times V_{OUT}^2}$$

For a design in which $V_{IN} = 3.3V$, $V_{OUT} = 70V$, $I_{OUT} = 3mA$, $\eta = 45\%$, $I_{LIM_LX} = 1.2A$, and $t_S = 2.5\mu s$: $L_{MAX} = 27\mu H$ and $L_{MIN} = 1.5\mu H$.

For a worse-case scenario in which $V_{IN} = 2.8V$, $V_{OUT} = 70V$, $I_{OUT} = 4mA$, $\eta = 43\%$, $I_{LIM_LX} = 1.2A$, and $t_S = 2.5\mu s$: $L_{MAX} = 15\mu H$ and $L_{MIN} = 2.2\mu H$.

The choice of $4.7\mu H$ is reasonable given the worst-case scenario above. In general, the higher the inductance, the lower the switching noise. Load regulation is also better with higher inductance.

76V, 300mW Boost Converter and Current Monitor for APD Bias Applications

Diode Selection

The MAX15059's high switching frequency demands a high-speed rectifier. Schottky diodes are recommended for most applications because of their fast recovery time and low forward-voltage drop. Ensure that the diode's peak current rating is greater than the peak inductor current. Also, the diode breakdown voltage must be greater than V_{OUT} .

Output Filter Capacitor Selection

For most applications, use a small output capacitor of 0.1 μ F or greater. To achieve low output ripple, a capacitor with low ESR, low ESL, and high capacitance value should be selected. If tantalum or electrolytic capacitors are used to achieve high capacitance values, always add a smaller ceramic capacitor in parallel to bypass the high-frequency components of the diode current. The higher ESR and ESL of electrolytic capacitors increase the output ripple and peak-to-peak transient voltage. Assuming the contribution from the ESR and capacitor discharge equals 50% (proportions may vary), calculate the output capacitance and ESR required for a specified ripple using the following equations:

$$C_{OUT}[\mu\text{F}] = \frac{I_{OUT}}{0.5 \times \Delta V_{OUT}} \left[t_S - \frac{I_{LPEAK} \times L_{OPTIMUM}}{(V_{OUT} - V_{IN_MIN})} \right]$$

$$ESR[m\Omega] = \frac{0.5 \times \Delta V_{OUT}}{I_{OUT}}$$

For very-low-output-ripple applications, the output of the boost converter can be followed by an RC filter to further reduce the ripple. Figure 2 shows a 100 Ω , 0.1 μ F (RF CF) filter used to reduce the switching output ripple to 1mV_{P-P} with a 0.1mA load or 1mV_{P-P} with a 4mA load. The output voltage regulation resistive divider must remain connected to the diode/output capacitor node.

Use X7R ceramic capacitors for more stability over the full temperature range.

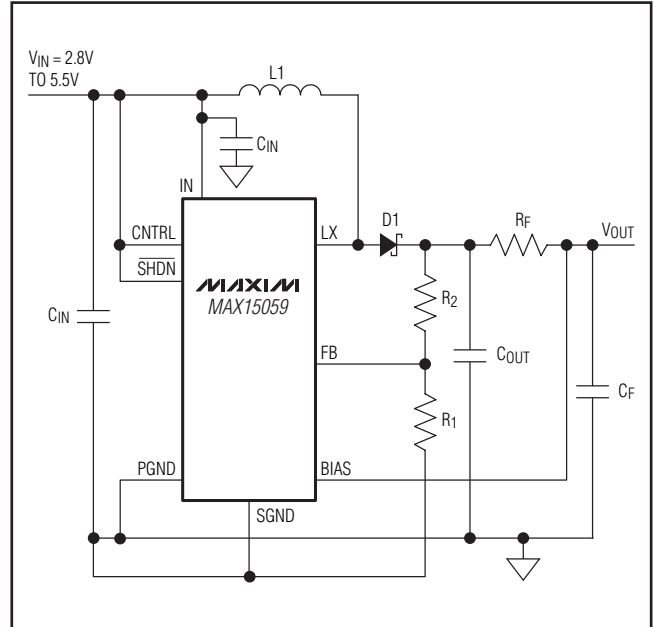

Figure 2. Typical Operating Circuit with RC Filter

Input-Capacitor Selection

Bypass IN to PGND with a 1 μ F (min) ceramic capacitor. Depending on the supply source impedance, higher values may be needed. Make sure that the input capacitors are close enough to the IC to provide adequate decoupling at IN as well. If the layout cannot achieve this, add another 0.1 μ F ceramic capacitor between IN and PGND in the immediate vicinity of the IC. Bulk aluminum electrolytic capacitors may be needed to avoid chattering at low-input voltage. In case of aluminum electrolytic capacitors, calculate the capacitor value and ESR of the input capacitor using the following equations:

$$C_{IN}[\mu\text{F}] = \frac{V_{OUT} \times I_{OUT}}{\eta \times V_{IN_MIN} \times 0.5 \times \Delta V_{IN}} \left[t_S - \frac{I_{LPEAK} \times L_{OPTIMUM} \times V_{OUT}}{V_{IN_MIN}(V_{OUT} - V_{IN_MIN})} \right]$$

$$ESR[m\Omega] = \frac{0.5 \times \Delta V_{IN} \times \eta \times V_{IN_MIN}}{V_{OUT} \times I_{OUT}}$$

76V, 300mW Boost Converter and Current Monitor for APD Bias Applications

Applications Information

Using APD or PIN Photodiodes in Fiber Applications

When using the MAX15059 to monitor APD or PIN photodiode currents in fiber applications, several issues must be addressed. In applications where the photodiode must be fully depleted, keep track of voltages budgeted for each component with respect to the available supply voltage(s). The current monitors require as much as 3.5V between BIAS and APD, which must be considered part of the overall voltage budget.

Additional voltage margin can be created if a negative supply is used in place of a ground connection, as long as the overall voltage drop experienced by the MAX15059 is less than or equal to 76V. For this type of application, the MAX15059 is suggested so the output can be referenced to “true” ground and not the negative supply. The MAX15059’s output current can be referenced as desired with either a resistor to ground or a transimpedance amplifier. Take care to ensure that output voltage excursions do not interfere with the required margin between BIAS and MOUT. In many fiber applications, MOUT is connected directly to an ADC that operates from a supply voltage that is less than the voltage at BIAS. Connecting the MAX15059’s clamping diode output, CLAMP, to the ADC power supply helps avoid damage to the ADC. Without this protection, voltages can develop at MOUT that might destroy the ADC. This protection is less critical when MOUT is connected directly to subsequent transimpedance amplifiers (linear or logarithmic) that have low-impedance, near-ground-referenced inputs. If a transimpedance amp is used on the low side of the photodiode, its voltage drop must also be considered. Leakage from the clamping diode is most often insignificant over nominal operating conditions, but grows with temperature.

To maintain low levels of wideband noise, lowpass filtering the output signal is suggested in applications where only DC measurements are required. Connect the filter capacitor at MOUT. Determining the required filtering components is straightforward, as the MAX15059 exhibits a very high output impedance of 5GΩ.

In some applications where pilot tones are used to identify specific fiber channels, higher bandwidths are desired at MOUT to detect these tones. Consider the minimum and maximum currents to be detected, then consult the frequency response and noise typical operating curves. If the minimum current is too small, insufficient bandwidth could result, while too high a current could result in excessive noise across the desired bandwidth.

Layout Considerations

Careful PCB layout is critical to achieve low switching losses and clean and stable operation. Protect sensitive analog grounds by using a star ground configuration. Connect SGND and PGND together close to the device at the return terminal of the output bypass capacitor. Do not connect them together anywhere else. Keep all PCB traces as short as possible to reduce stray capacitance, trace resistance, and radiated noise. Ensure that the feedback connection to FB is short and direct. Route high-speed switching nodes away from the sensitive analog areas. Use an internal PCB layer for SGND as an EMI shield to keep radiated noise away from the device, feedback dividers, and analog bypass capacitors. Refer to the MAX15059 Evaluation Kit data sheet for a layout example.

Chip Information

PROCESS: BiCMOS

Package Information

For the latest package outline information and land patterns, go to www.maxim-ic.com/packages. Note that a “+”, “#”, or “-” in the package code indicates RoHS status only. Package drawings may show a different suffix character, but the drawing pertains to the package regardless of RoHS status.

| PACKAGE TYPE | PACKAGE CODE | OUTLINE NO. | LAND PATTERN NO. |
|--------------|--------------|-------------------------|-------------------------|
| 16 TQFN-EP | T1633-4 | 21-0136 | 90-0031 |

76V, 300mW Boost Converter and Current Monitor for APD Bias Applications

Revision History

| REVISION NUMBER | REVISION DATE | DESCRIPTION | PAGES CHANGED |
|-----------------|---------------|--|------------------|
| 0 | 1/10 | Initial release | — |
| 1 | 3/10 | Replaced five TOCs, added three TOCs, updated text | 1, 2, 3, 5–8, 11 |
| 2 | 7/10 | EC table specifications modified | 2, 3 |
| 3 | 11/10 | EC table extended to +125°C | 1–8, 14 |

Maxim cannot assume responsibility for use of any circuitry other than circuitry entirely embodied in a Maxim product. No circuit patent licenses are implied. Maxim reserves the right to change the circuitry and specifications without notice at any time.

16 **Maxim Integrated Products, 120 San Gabriel Drive, Sunnyvale, CA 94086 408-737-7600**