



Chipsmall Limited consists of a professional team with an average of over 10 year of expertise in the distribution of electronic components. Based in Hongkong, we have already established firm and mutual-benefit business relationships with customers from,Europe,America and south Asia,supplying obsolete and hard-to-find components to meet their specific needs.

With the principle of “Quality Parts,Customers Priority,Honest Operation,and Considerate Service”,our business mainly focus on the distribution of electronic components. Line cards we deal with include Microchip,ALPS,ROHM,Xilinx,Pulse,ON,Everlight and Freescale. Main products comprise IC,Modules,Potentiometer,IC Socket,Relay,Connector.Our parts cover such applications as commercial,industrial, and automotives areas.

We are looking forward to setting up business relationship with you and hope to provide you with the best service and solution. Let us make a better world for our industry!



Contact us

Tel: +86-755-8981 8866 Fax: +86-755-8427 6832

Email & Skype: info@chipsmall.com Web: www.chipsmall.com

Address: A1208, Overseas Decoration Building, #122 Zhenhua RD., Futian, Shenzhen, China





MAX15066 Evaluation Kit

General Description

The MAX15066 evaluation kit (EV kit) provides a proven design to evaluate the MAX15066 high-efficiency, 4A, step-down regulator with integrated switches. The EV kit is preset for 1.8V output at load currents up to 4A from a 4.5V to 16V input supply.

Features

- ◆ 4.5V to 16V Input Voltage Range
- ◆ Fixed 500kHz Switching Frequency
- ◆ Adjustable Output Voltage Range from 0.606V to (0.9 x V_{IN})
- ◆ Proven PCB Layout
- ◆ Fully Assembled and Tested

Ordering Information

PART	TYPE
MAX15066EVKIT+	EV Kit

+Denotes lead(Pb)-free and RoHS compliant.

Component List

DESIGNATION	QTY	DESCRIPTION
C1	1	47 μ F \pm 20%, 25V aluminum electrolytic capacitor (6.3mm x 5.8mm) Panasonic EEEFK1E470P
C2	1	10 μ F \pm 10%, 25V X5R ceramic capacitor (1206) Murata GRM31CR61E106K
C3	1	0.1 μ F \pm 10%, 25V X7R ceramic capacitor (0603) Murata GRM188R71E104K
C4	1	1 μ F \pm 10%, 16V X7R ceramic capacitor (0603) Murata GRM188R71C105K
C7, C8	2	0.01 μ F \pm 10%, 25V X7R ceramic capacitors (0603) Murata GRM188R71E103K
C9	1	47 μ F \pm 10%, 10V X5R ceramic capacitor (1210) Murata GRM32ER61A476K
C11	0	Not installed, ceramic capacitor (1210)
C12, C14	0	Not installed, ceramic capacitors (0603)

DESIGNATION	QTY	DESCRIPTION
C13	1	2.7nF \pm 10%, 50V X7R ceramic capacitor (0603) Murata GRM188R71H272K
C15	1	47pF \pm 5%, 50V C0G ceramic capacitor (0603) Murata GRM1885C1H470J
EN	1	2-pin header Sullins PEC36SAAN
L1	1	2.2 μ H, 15A inductor TOKO FDA1055-2R2M
R2, R6, R8	3	10k Ω \pm 1% resistors (0603)
R4	0	Not installed, resistor (0603)
R5	1	20k Ω \pm 1% resistor (0603)
R7	1	5.11k Ω \pm 1% resistor (0603)
R10	1	1 Ω \pm 1% resistor (0603)
U1	1	Synchronous 4A buck converter (16 WLP) Maxim MAX15066EWE+
—	1	Shunt
—	1	PCB: MAX15066 EVALUATION KIT+

Evaluates: MAX15066

MAX15066 Evaluation Kit

Component suppliers

SUPPLIER	PHONE	WEBSITE
Murata Electronics North America, Inc.	770-436-1300	www.murata-northamerica.com
Panasonic Corp.	800-344-2112	www.panasonic.com
Sullins Electronics Corp.	760-744-0125	www.sullinselectronics.com
TOKO America, Inc.	847-297-0070	www.tokoam.com

Note: Indicate that you are using the MAX15066 when contacting these component suppliers.

Quick Start

Recommended Equipment

- MAX15066 EV kit
- 12V, 4A DC power supply
- Load capable of 4A
- Digital voltmeter

Procedure

The EV kit is fully assembled and tested. Follow the steps below to verify board operation. **Caution: Do not turn on power supply until all connections are completed.**

- 1) Connect the positive terminal of the 12V supply to the IN connector and the negative terminal to the nearest GND connector.
- 2) Connect the positive terminal of the 4A load to the VOUT connector and the negative terminal to the nearest GND connector.
- 3) Connect the digital voltmeter across the VOUT connector and the nearest GND connector.
- 4) Verify that a shunt is not installed on the EN jumper.
- 5) Turn on the DC power supply.
- 6) Enable the load.
- 7) Verify that the voltmeter displays 1.8V.

Detailed Description of Hardware

The MAX15066 EV kit evaluates the MAX15066 current-mode, synchronous, DC-DC buck converter. The EV kit is preset for 1.8V and delivers an output current up to 4A with high efficiency. The EV kit operates from an input voltage of 4.5V to 16V. The EV kit provides an adjustable output voltage from 0.606V to 90% of the input voltage through resistor-dividers R5 and R6. The EV kit features independent device-enable control (EN) and power-good (PGOOD) signals that allow for flexible power sequencing.

Soft-Start (SS)

The EV kit utilizes an adjustable soft-start function to limit inrush current during startup. The soft-start time is adjusted by the value of C7, the external capacitor from SS to GND. By default, C7 is currently 0.01 μ F, which gives a soft-start time of approximately 1.2ms. To adjust the soft-start time, determine C7 using the following formula:

$$C7 = (5\mu\text{A} \times t_{\text{SS}}) / 0.606\text{V}$$

where t_{SS} is the required soft-start time in seconds and C7 is in farads.

MAX15066 Evaluation Kit

Evaluates: MAX15066

Setting Output Voltage

The EV kit can be adjusted from 0.606V to $(0.9 \times V_{IN})$ by changing the values of R5 and R6. To determine the value of the resistor-divider, first select R6 from 5k Ω to 50k Ω and then use the following equation to calculate R5:

$$R5 = R6 \times \left(\frac{V_{OUT}}{V_{FB}} - 1 \right)$$

where the feedback threshold voltage $V_{FB} = 0.606V$ (typ). When regulating an output of 0.606V, short FB to OUT and keep R6 connected from FB to GND.

If a different output voltage is desired, revisit the feedback resistor-divider (R5), the inductor, and output-capacitor calculations (refer to the *Inductor Selection* and *Output-Capacitor Selection* sections in the MAX15066 IC data sheet). The compensation components (R7, C13, C14, and C15) must be recalculated to ensure loop stability (refer to the *Compensation Design Guidelines* section in the MAX15066 IC data sheet).

Regulator Enable (EN)

To shut down the converter, install a shunt on jumper EN. For normal operation, remove the shunt from EN. See Table 1 to configure jumper EN.

Power Good (PGOOD)

PGOOD is an open-drain output that goes high impedance when V_{FB} exceeds 0.56V (typ). PGOOD is internally pulled low when V_{FB} falls below 0.545V (typ). PGOOD also becomes low during shutdown. On the EV kit, the PGOOD test point is pulled up to VDD through resistor R8. Use the GND PCB pad as a ground reference for this signal.

Table 1. Regulator Enable (EN) Jumper EN Description

SHUNT POSITION	DESCRIPTION
Installed	Disables the device
Not installed*	Normal operation

*Default position.

Evaluates: MAX15066

MAX15066 Evaluation Kit

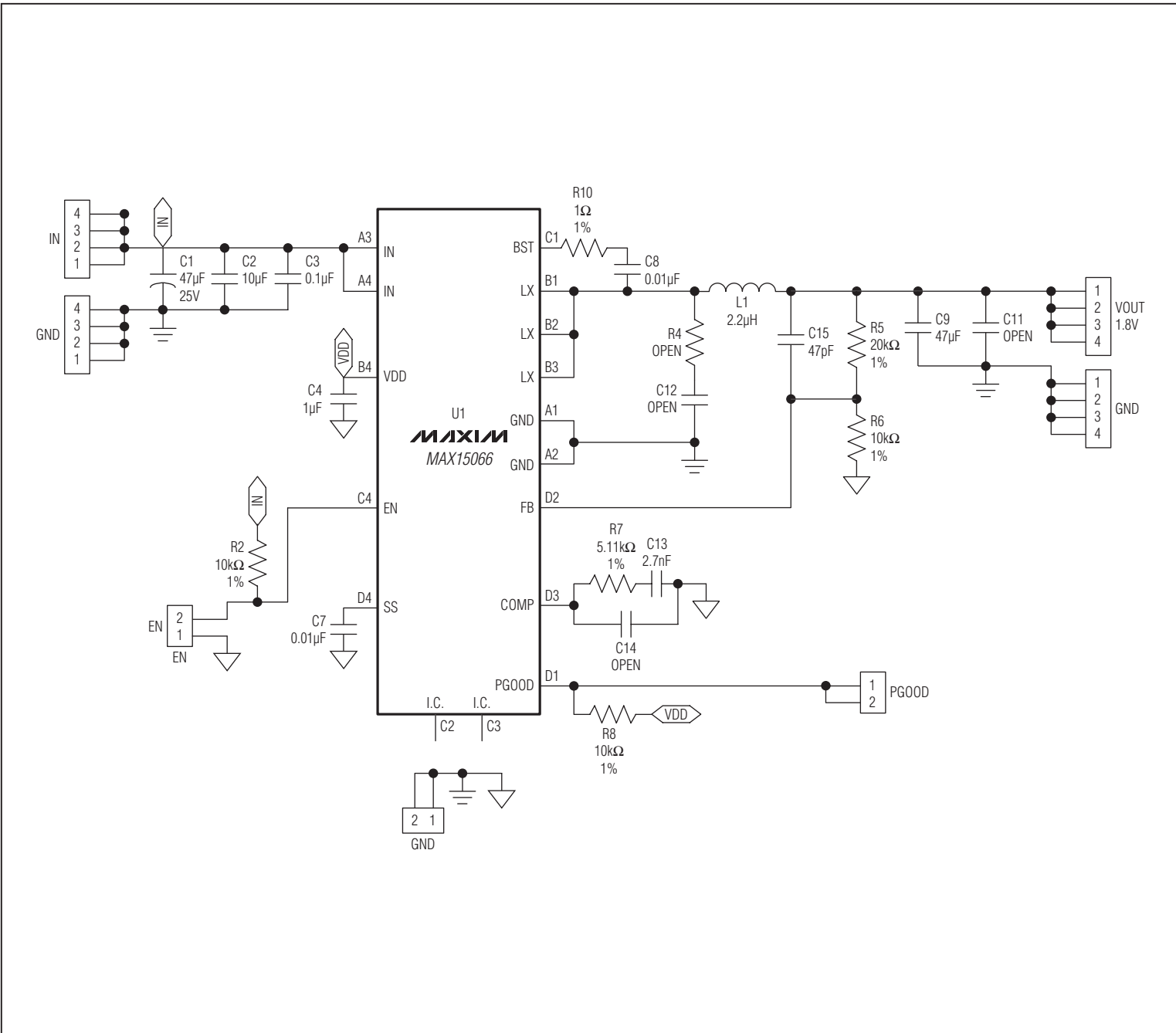

Figure 1. MAX15066 EV Kit Schematic

MAX15066 Evaluation Kit

Evaluates: MAX15066

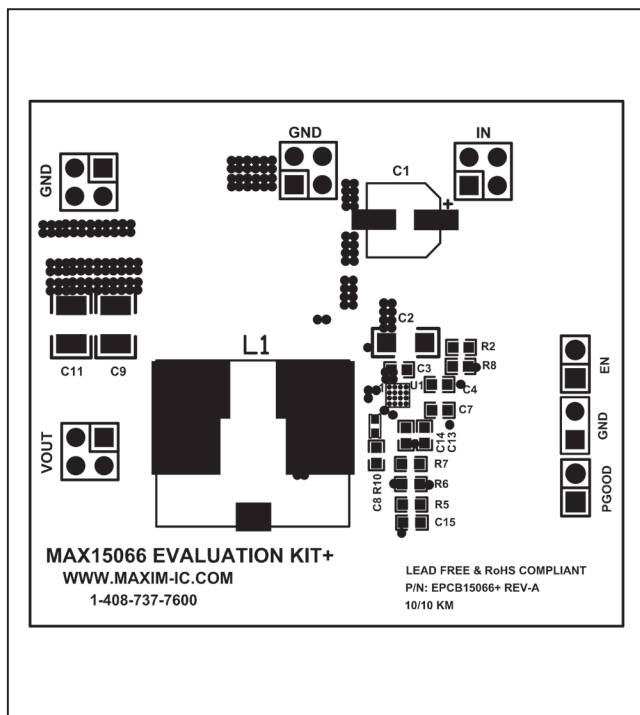

Figure 2. MAX15066 EV Kit Component Placement Guide—Component Side

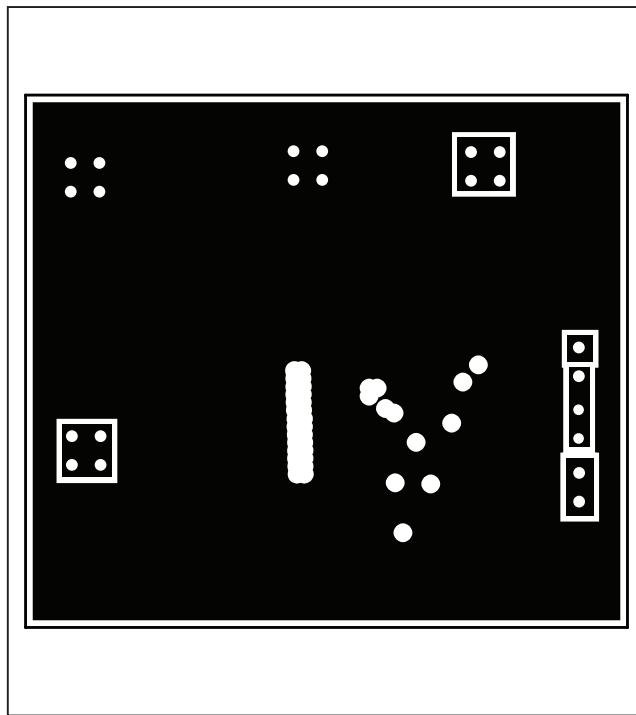

Figure 4. MAX15066 EV Kit PCB Layout—Inner Layer 2

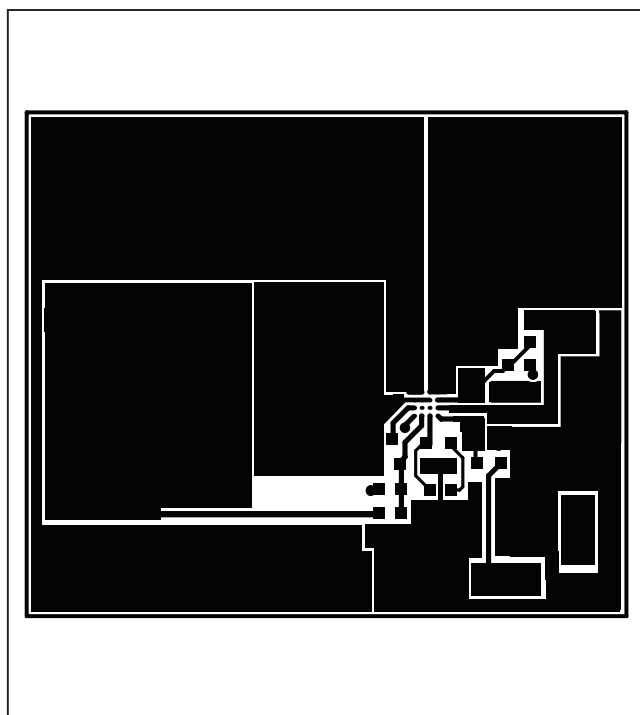

Figure 3. MAX15066 EV Kit PCB Layout—Component Side

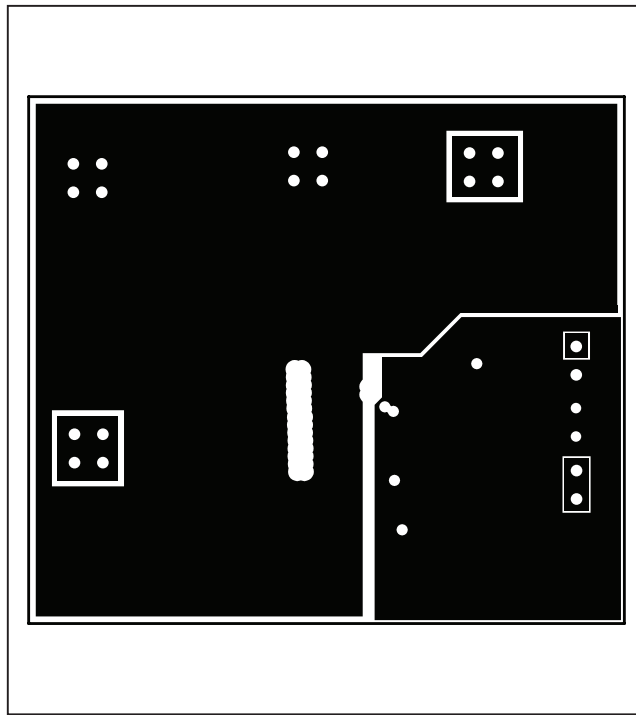

Figure 5. MAX15066 EV Kit PCB Layout—Inner Layer 3

MAX15066 Evaluation Kit

Evaluates: MAX15066

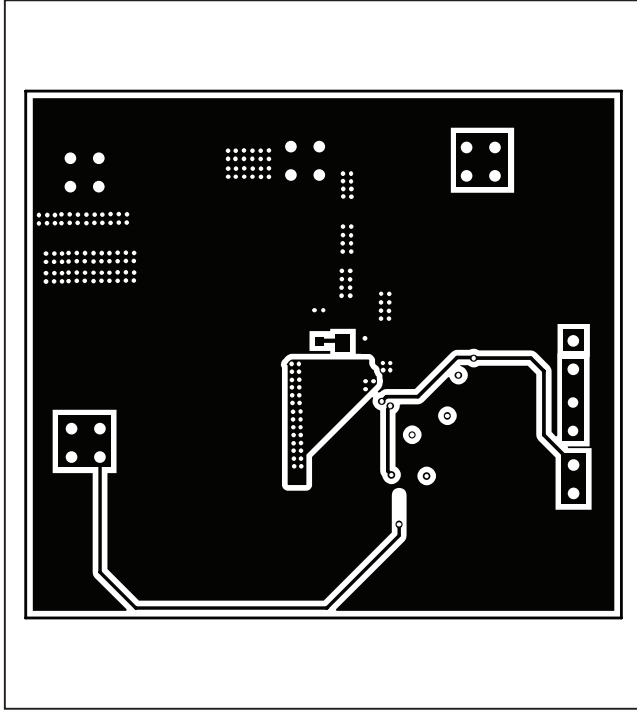

Figure 6. MAX15066 EV Kit PCB Layout—Solder Side

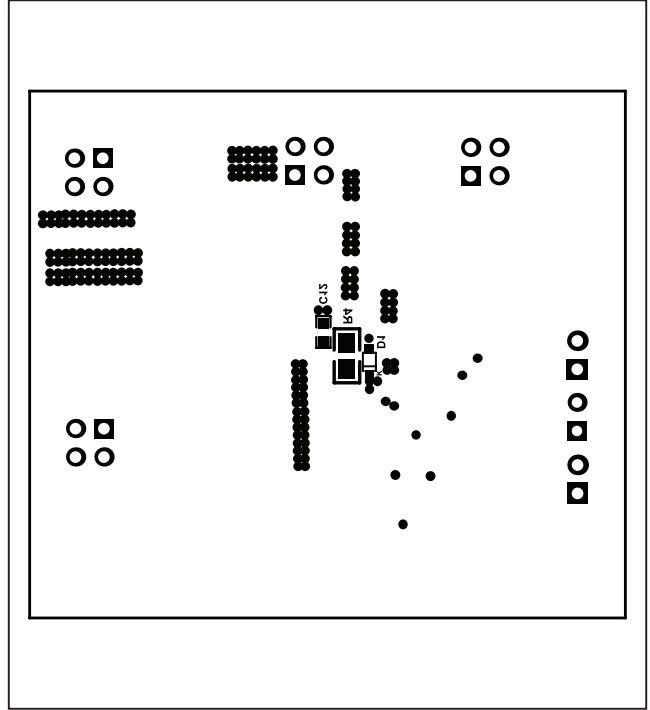

Figure 7. MAX15066 EV Kit Component Placement Guide—Solder Side

MAX15066 Evaluation Kit

Revision History

REVISION NUMBER	REVISION DATE	DESCRIPTION	PAGES CHANGED
0	11/10	Initial release	—

Evaluates: MAX15066

Maxim cannot assume responsibility for use of any circuitry other than circuitry entirely embodied in a Maxim product. No circuit patent licenses are implied. Maxim reserves the right to change the circuitry and specifications without notice at any time.

Maxim Integrated Products, 120 San Gabriel Drive, Sunnyvale, CA 94086 408-737-7600 _____ 7