



Chipsmall Limited consists of a professional team with an average of over 10 year of expertise in the distribution of electronic components. Based in Hongkong, we have already established firm and mutual-benefit business relationships with customers from,Europe,America and south Asia,supplying obsolete and hard-to-find components to meet their specific needs.

With the principle of "Quality Parts,Customers Priority,Honest Operation,and Considerate Service",our business mainly focus on the distribution of electronic components. Line cards we deal with include Microchip,ALPS,ROHM,Xilinx,Pulse,ON,Everlight and Freescale. Main products comprise IC,Modules,Potentiometer,IC Socket,Relay,Connector.Our parts cover such applications as commercial,industrial, and automotives areas.

We are looking forward to setting up business relationship with you and hope to provide you with the best service and solution. Let us make a better world for our industry!



Contact us

Tel: +86-755-8981 8866 Fax: +86-755-8427 6832

Email & Skype: info@chipsmall.com Web: www.chipsmall.com

Address: A1208, Overseas Decoration Building, #122 Zhenhua RD., Futian, Shenzhen, China





MAXIM

White LED Camera-Flash Boost Converter

MAX1583

General Description

The MAX1583 white LED boost converter drives up to five white LEDs with a constant current to provide camera flash/strobe in cell phones, PDAs, DSCs, and other hand-held devices. The MAX1583 includes a 24V boost converter and a high-voltage LDO current regulator for high efficiency and long battery life. Two logic inputs control four modes of operation: shutdown mode (0.5µA max), movie mode for high-efficiency continuous lighting (programmable up to 100mA), precharge mode for charging a reservoir capacitor to 24V while the LEDs are off (POK output indicates a full reservoir capacitor), and strobe mode for firing the flash during an exposure with a regulated current programmable up to 300mA.

The MAX1583X, MAX1583Y, and MAX1583Z offer high, medium, and low current limits, respectively, to allow tradeoff between reservoir capacitor size and peak input current.

The MAX1583 is available in a 10-pin 3mm x 3mm TDFN package (0.8mm max height).

Applications

- Camera Flashes/Strobes
- Cell Phones and Smart Phones
- PDAs and Digital Still Cameras

Typical Operating Circuit

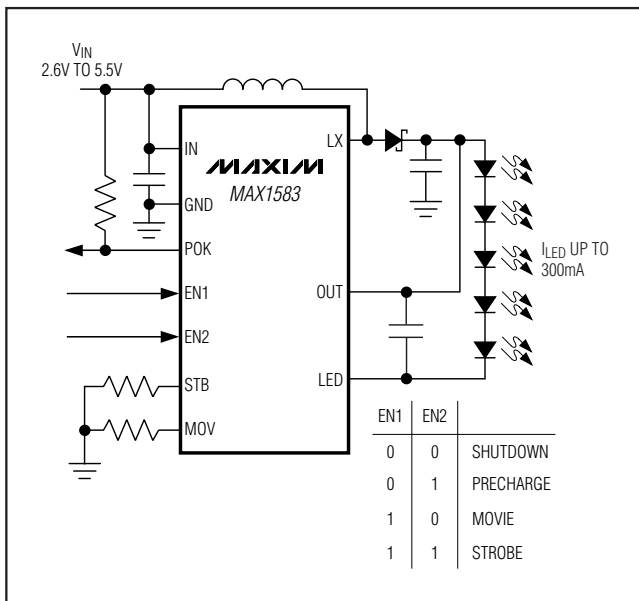

Features

- ◆ Supports Up to Five LEDs for Strobe or Flash
- ◆ Four Operational Modes
 - Strobe: Up to 300mA
 - Precharge: With POK Indicator
 - Movie: Up to 100mA
 - Shutdown: 0.01µA (typ) Quiescent Current
- ◆ Input Current Limiting
 - 1A (MAX1583X)
 - 500mA (MAX1583Y)
 - 250mA (MAX1583Z)
- ◆ Small External Components
- ◆ 2.6V to 5.5V Input Range
- ◆ 24V Output Overvoltage Protection
- ◆ 80% Efficient (PLED / PIN) Movie Mode
- ◆ Thermal-Shutdown Protection
- ◆ 10-Pin 3mm x 3mm TDFN Package

Ordering Information

PART	TEMP RANGE	PIN-PACKAGE
MAX1583XETB-T	-40°C to +85°C	10 TDFN 3mm x 3mm
MAX1583XETB+T	-40°C to +85°C	10 TDFN 3mm x 3mm

+Denotes lead-free package.

Ordering Information continued at end of data sheet.

Selector Guide

PART	CURRENT LIMIT	TOP MARK
MAX1583XETB	1A	ACJ
MAX1583YETB	500mA	ACK
MAX1583ZETB	250mA	ACL

Pin Configuration

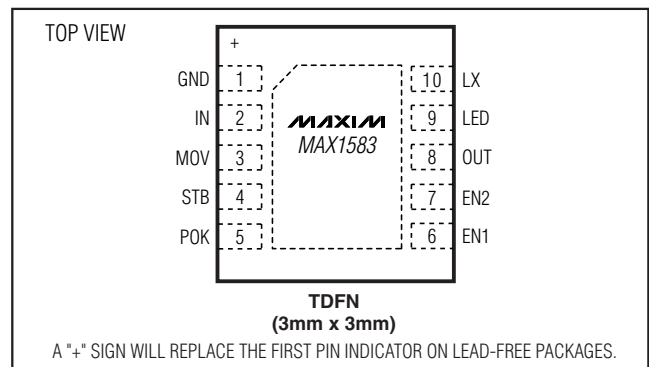

White LED Camera-Flash Boost Converter

ABSOLUTE MAXIMUM RATINGS

IN, EN1, EN2, POK to GND	-0.3V to +6V
LX, OUT to GND	-0.3V to +30V
STB, MOV to GND	-0.3V to (V _{IN} + 0.3V)
LED to GND	-0.3V to (V _{OUT} + 0.3V)
I _{LX}	1.2A _{RMS}

Continuous Power Dissipation (T _A = +70°C) 10-Pin 3mm x 3mm TDFN (derate 24.4mW/°C above +70°C)	1951mW
Operating Temperature Range	-40°C to +85°C
Junction Temperature	+150°C
Storage Temperature Range	-65°C to +150°C
Lead Temperature (soldering, 10s)	+300°C

Stresses beyond those listed under "Absolute Maximum Ratings" may cause permanent damage to the device. These are stress ratings only, and functional operation of the device at these or any other conditions beyond those indicated in the operational sections of the specifications is not implied. Exposure to absolute maximum rating conditions for extended periods may affect device reliability.

ELECTRICAL CHARACTERISTICS

(V_{IN} = V_{EN1} = 3.0V, V_{EN2} = 0V, V_{OUT} = 20V, C_{OUT} = 10μF, T_A = -40°C to +85°C, unless otherwise noted. Typical values are at T_A = +25°C. Note 1)

PARAMETER	CONDITIONS	MIN	TYP	MAX	UNITS	
Supply Voltage		2.6		5.5	V	
Undervoltage-Lockout Threshold	V _{IN} rising, hysteresis = 40mV (typ)	2.10	2.38	2.55	V	
OUT Input Bias Current		4	10	15	μA	
Quiescent-Current Precharge Mode	LX switching, LEDs off	2			mA	
	LX not switching, LEDs off	0.32				
Quiescent-Current Shutdown Mode	EN1 = EN2 = GND	T _A = +25°C	0.01	0.5	μA	
		T _A = +85°C	0.1			
Output Overvoltage-Lockout Threshold	V _{OUT} rising, precharge or movie mode, hysteresis = 500mV (typ)	22.5	24	25.5	V	
LED Regulation Voltage Threshold	V _{LED} rising, movie mode	0.5	0.6	0.7	V	
LED Input Leakage Current	Precharge mode	T _A = +25°C	0.01	1	μA	
		T _A = +85°C	0.1			
MOV, STB Regulation Voltage		600			mV	
Current-Source Multiplier in Movie Mode	I _{LED} / I _{MOV} , I _{MOV} up to 300μA	100			A/A	
Current-Source Accuracy, Movie Mode	R _{MOV} = 2kΩ, V _{LED} = 0.5V	-7	±1	+7	%	
MOV Current-Source Dropout Voltage	I _{LED} = 25mA, R _{MOV} = 2kΩ	0.1			V	
Current-Source Multiplier in Strobe Mode	I _{LED} / I _{STB} , I _{STB} up to 300μA	1000			A/A	
Current-Source Accuracy, Strobe Mode	R _{STB} = 2kΩ, V _{LED} = 3.0V	-10	±1.5	+10	%	
STB Current-Source Dropout Voltage	I _{LED} = 250mA, R _{STB} = 2kΩ	0.9			V	
Current Limit	MAX1583X	800	1000	1200	mA	
	MAX1583Y	400	500	600		
	MAX1583Z	200	250	300		
POK Low Voltage	I _{SINK} = 1mA	0.05			0.1	V
POK Leakage	T _A = +25°C	0.01			1	μA
	T _A = +85°C	0.1				

White LED Camera-Flash Boost Converter

MAX1583

ELECTRICAL CHARACTERISTICS (continued)

($V_{IN} = V_{EN1} = 3.0V$, $V_{EN2} = 0V$, $V_{OUT} = 20V$, $C_{OUT} = 10\mu F$, $T_A = -40^\circ C$ to $+85^\circ C$, unless otherwise noted. Typical values are at $T_A = +25^\circ C$. Note 1)

PARAMETER	CONDITIONS	MIN	TYP	MAX	UNITS
EN1 and EN2 Input High Threshold	$V_{IN} = 2.6V$ to $5.5V$	1.6			V
EN1 and EN2 Input Low Threshold	$V_{IN} = 2.6V$ to $5.5V$			0.6	V
EN1 and EN2 Input Leakage	$EN_{-} = IN$	$T_A = +25^\circ C$	0.01	1	μA
		$T_A = +85^\circ C$	0.1		
LX On-Resistance	$I_{LX} = 200mA$		1.3	2.25	Ω
LX Leakage	$V_{LX} = 28V$	$T_A = +25^\circ C$	0.01	5	μA
		$T_A = +85^\circ C$	0.1		
Operating Frequency	$T_A = 0^\circ C$ to $+85^\circ C$	0.8	1.0	1.2	MHz
	$T_A = -40^\circ C$ to $+85^\circ C$	0.75		1.25	
Maximum Duty Cycle	Switching	90	94		%
Minimum Duty Cycle	Pulse skipping		0		%

Note 1: All units are 100% production tested at $T_A = +25^\circ C$. Limits over the operating temperature range are guaranteed by design.

Typical Operating Characteristics

($V_{IN} = 3.3V$, $C_{RES} = 10\mu F$, MAX1583Y, 4 LEDs in a 2×2 array, $T_A = +25^\circ C$, unless otherwise noted.)

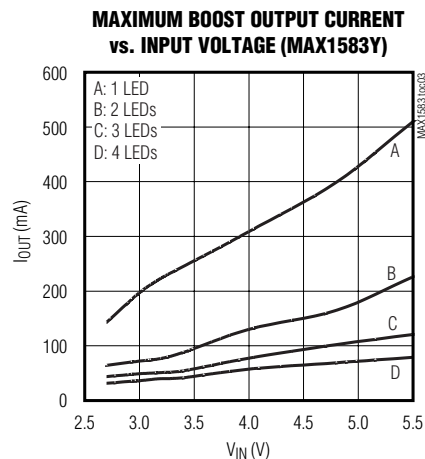
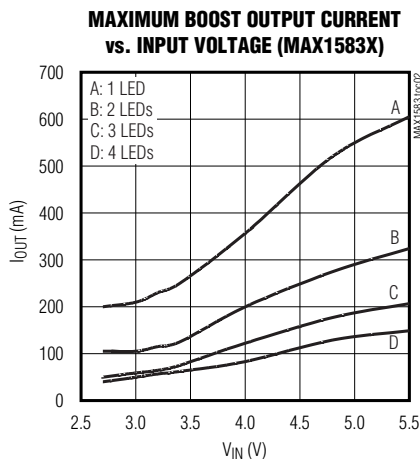
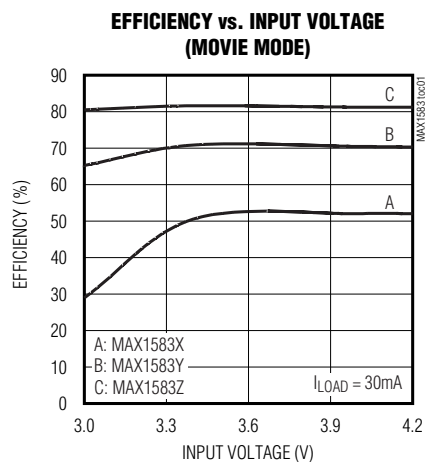

White LED Camera-Flash Boost Converter

Typical Operating Characteristics (continued)

($V_{IN} = 3.3V$, $C_{RES} = 10\mu F$, MAX1583Y, 4 LEDs in a 2 x 2 array, $T_A = +25^\circ C$, unless otherwise noted.)

MAXIMUM BOOST OUTPUT CURRENT vs. INPUT VOLTAGE (MAX1583Z)

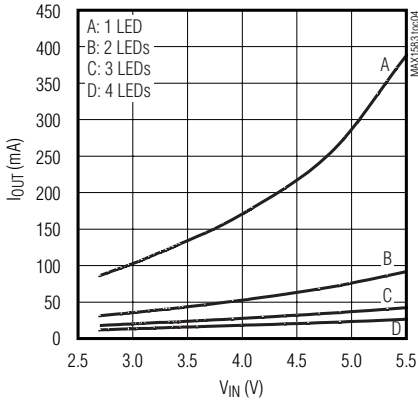

STROBE-MODE LED CURRENT vs. STB RESISTANCE

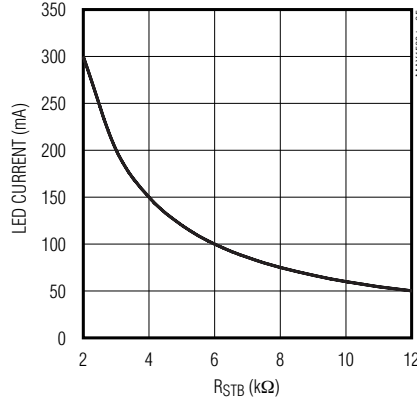

MOVIE-MODE LED CURRENT vs. MOV RESISTANCE

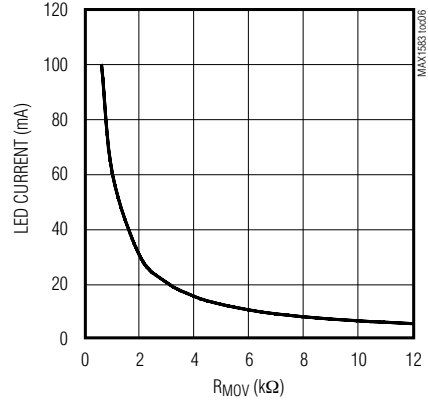

STROBE STANDBY-MODE INPUT CURRENT vs. INPUT VOLTAGE (PRECHARGE DONE)

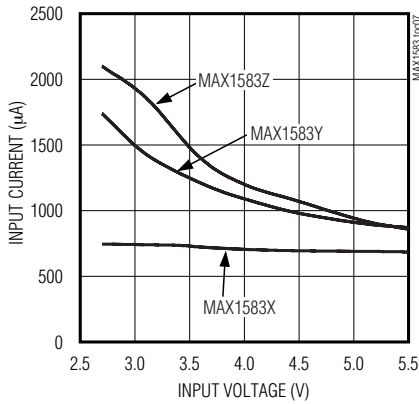

SWITCHING WAVEFORMS IN MOVIE MODE

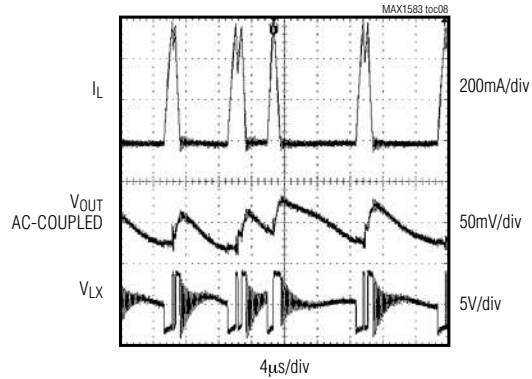

SWITCHING WAVEFORMS DURING PRECHARGE MODE

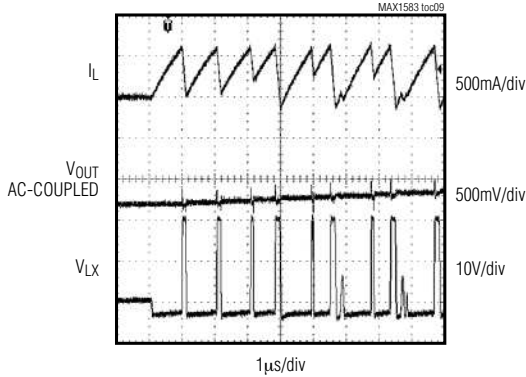

SWITCHING WAVEFORMS IN STANDBY MODE

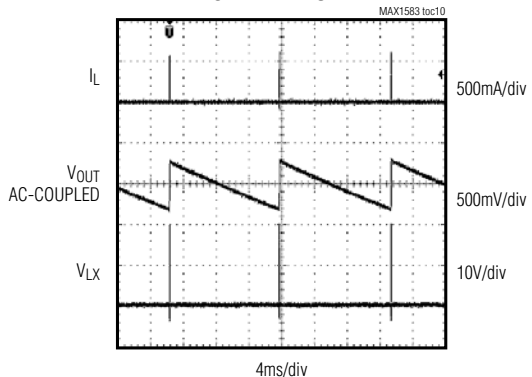

White LED Camera-Flash Boost Converter

MAX1583

Typical Operating Characteristics (continued)

($V_{IN} = 3.3V$, $C_{RES} = 10\mu F$, MAX1583Y, 4 LEDs in a 2 x 2 array, $T_A = +25^\circ C$, unless otherwise noted.)

SWITCHING WAVEFORMS IN STROBE MODE

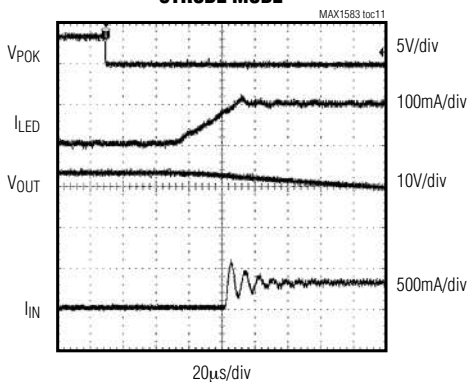

PRECHARGE-CYCLE WAVEFORMS (MAX1583X)

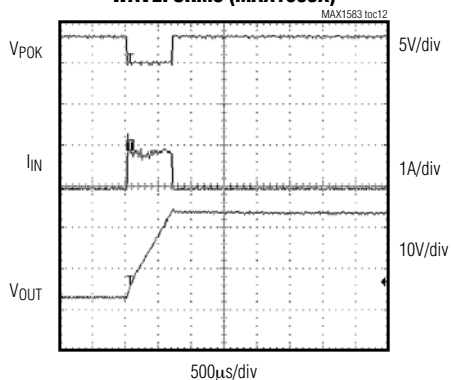

PRECHARGE-CYCLE WAVEFORMS (MAX1583Y)

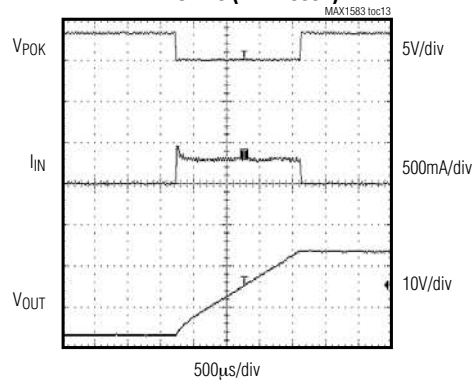

PRECHARGE-CYCLE WAVEFORMS (MAX1583Z)

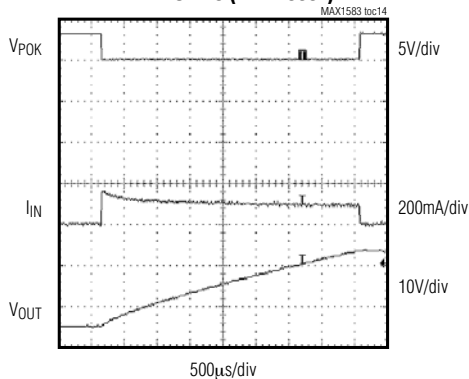

STROBE-PULSE WAVEFORMS (MAX1583X)

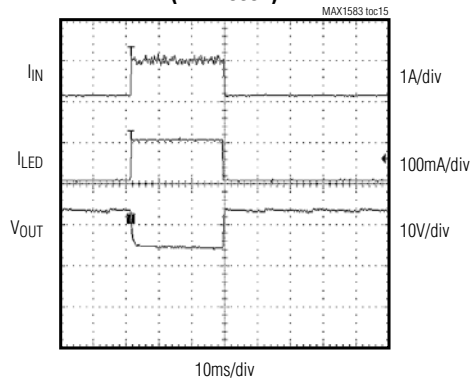

STROBE-PULSE WAVEFORMS (MAX1583Y)

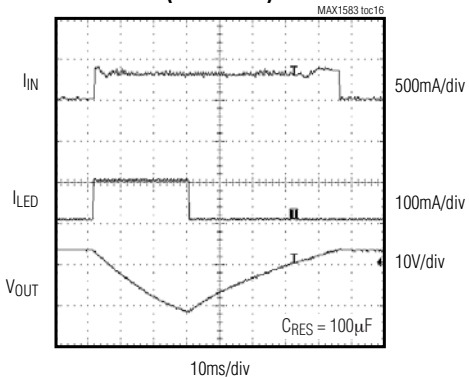

STROBE-PULSE WAVEFORMS (MAX1583Z)

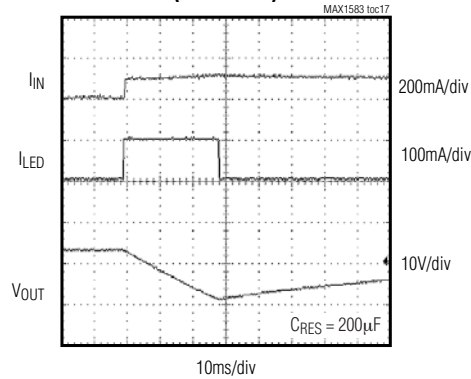

White LED Camera-Flash Boost Converter

Pin Description

PIN	NAME	FUNCTION
1	GND	Ground. Connect to exposed paddle.
2	IN	Input Voltage Supply. Input voltage range is 2.6V to 5.5V. Bypass IN to GND with a 4.7μF ceramic capacitor.
3	MOV	Movie Current-Set Input. Connect a resistor from MOV to GND to set the LED current for movie-mode operation. $R_{MOV} = 60 / I_{LED}$ (where $R_{MOV} > 600k\Omega$).
4	STB	Strobe Current-Set Input. Connect a resistor from STB to GND to set the LED current for strobe-mode operation. $R_{STB} = 600 / I_{LED}$ (where $R_{STB} > 2k\Omega$).
5	POK	Power-OK Output. Pulled to GND during precharge mode. POK goes high impedance once V_{OUT} reaches 24V.
6	EN1	Enable 1. EN1 and EN2 are digital inputs that determine the operational mode of the MAX1583. See Table 1.
7	EN2	Enable 2. EN1 and EN2 are digital inputs that determine the operational mode of the MAX1583. See Table 1.
8	OUT	Output-Voltage Sense Input. The boost-converter circuit in the MAX1583 is disabled once V_{OUT} is greater than 24V. When V_{OUT} falls below 23.5V, the converter is enabled.
9	LED	LED Return Input. Connect to the cathode of the series LEDs. Regulates to 0.6V in movie mode. LED is high impedance during shutdown and precharge mode.
10	LX	Inductor Connection. Drain of the internal power MOSFET. Connect to the switched side of the inductor. LX is high impedance during shutdown.
—	EP	Exposed Paddle. Connect to the circuit ground plane.

Functional Diagram

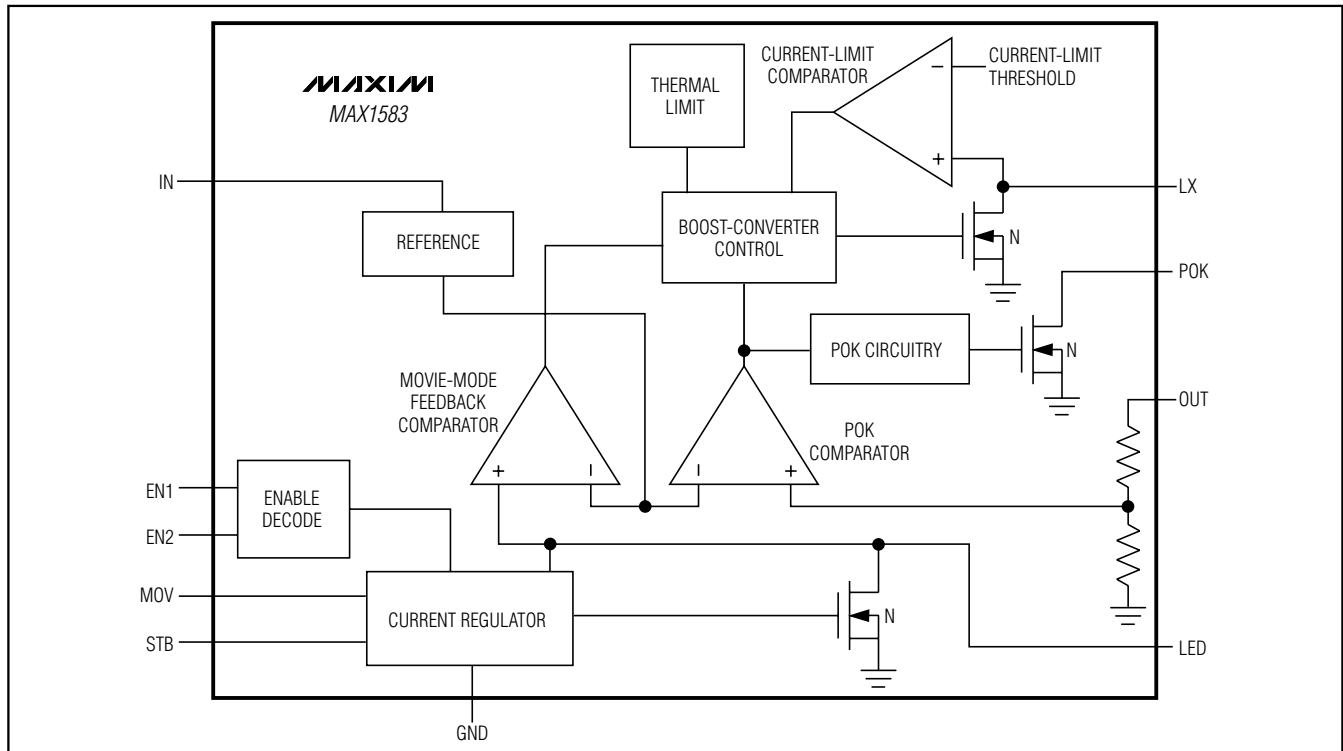

White LED Camera-Flash Boost Converter

Detailed Description

The MAX1583 provides power and control for up to five white LEDs. The MAX1583 consists of a gated oscillator, a 24V boost converter, and an LED current-regulation circuit, and operates from 2.6V to 5.5V input supply voltages. The MAX1583 operates in one of four user-selectable modes (Table 1). The precharge mode charges the output capacitor to 24V for quick transients to strobe mode. The POK output indicates the output has reached its regulation value of 24V and is ready for a strobe pulse. In movie mode, the LED current is regulated at a user-selectable level for constant lighting. Strobe mode regulates the LED current to a user-selectable high-intensity level for still picture use. When the MAX1583 is not in use, it can be put in shutdown mode, reducing the input current to 0.01 μ A (typ).

Table 1. Enable Inputs

EN1	EN2	MODE
0	0	Shutdown
0	1	Precharge
1	0	Movie
1	1	Strobe

Boost Converter

The heart of the MAX1583 is a gated oscillator boost converter that is used to supply the LED current. The boost converter is active when the feedback input voltage (V_{LED}) is below the regulation threshold (0.6V) and V_{OUT} is below the overvoltage-lockout threshold (24V).

During switching cycles, the 94% (typ) duty cycle, 1MHz oscillator switches an internal power MOSFET. On the rising edge of each clock cycle, the MOSFET is turned on, ramping up current and storing energy in the external inductor. On the falling edge of the oscillator, the MOSFET is turned off, allowing the energy stored in the inductor to be transferred to the output. Under normal operation, the MOSFET turns on or off only at the beginning or end of the oscillator cycle. This ensures there are no short-duration pulses. Exceeding the current limit or thermal limit, or pulling EN1 and EN2 low, immediately turns the MOSFET off.

Current Regulator

The MAX1583 controls the brightness by regulating the current through the external LEDs to a user-selectable level. In movie mode, the current into LED is regulated to 100 times the current set by the MOV resistor, R_{MOV} . In strobe mode, the current into LED is regulated to 1000 times the current set by the STB resistor, R_{STB} .

Precharge Mode

Drive EN1 low and EN2 high to enable precharge mode. In this mode, the boost converter switches continuously until the output capacitor is charged to 24V. Once V_{OUT} reaches 24V, POK goes high impedance and the MAX1583 does not switch again until V_{OUT} falls below 23.5V. This results in a 500mV ripple on the output during this mode. LED is high impedance in precharge mode; therefore, the external LEDs are off.

POK Output

An open-drain, power-OK output (POK) is low until V_{OUT} reaches 24V. Once the threshold is reached, POK is latched in a high-impedance state. The latch is reset in strobe, precharge, or movie mode.

Strobe Mode

Drive EN1 and EN2 high to enable strobe mode. In this mode, the boost converter switches continuously to supply maximum current for the LEDs unless limited by overvoltage lockout. The current through the LEDs is regulated to 1000 times the current set by the STB resistor. See the *Adjusting the LED Current* section for details on setting the strobe-mode current. The time duration of the strobe mode must be set using external circuitry or software.

Movie Mode

Drive EN1 high and EN2 low to enable movie mode. In this mode, the boost converter switches as necessary to maintain V_{LED} at 0.6V, and the current regulator regulates the current through LED to 100 times the current set by the MOV resistor. See the *Adjusting the LED Current* section for details on setting the movie-mode current.

Shutdown Mode

Drive EN1 and EN2 low to place the MAX1583 into a low-power shutdown mode. LED is high impedance during shutdown, eliminating the DC conduction path that exists in the typical boost topology.

White LED Camera-Flash Boost Converter

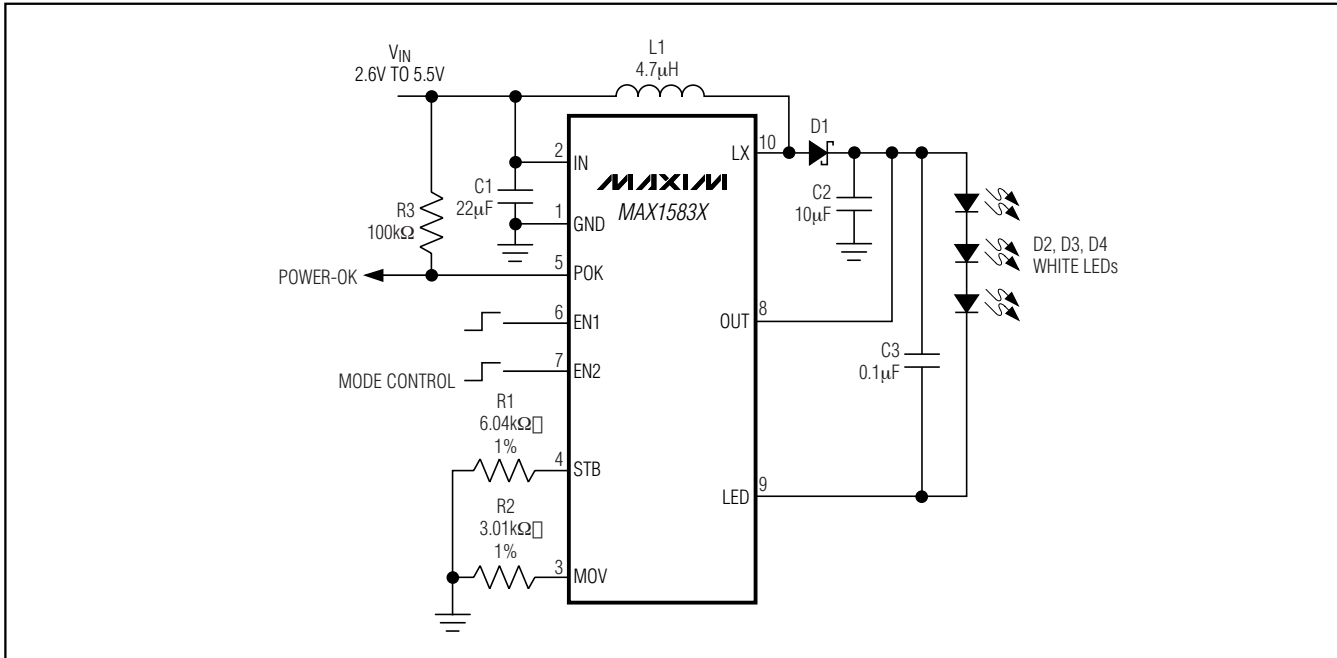

Figure 1. Typical Application Circuit

Design Procedure

Adjusting the LED Current

The LED current in the strobe and movie modes is programmable using external resistors. To set the LED current during strobe mode, connect a resistor (R_{STB}) from STB to GND. V_{STB} is regulated to 0.6V and the current sourced by STB is mirrored through LED with a gain of 1000. R_{STB} is calculated as:

$$R_{STB} = 600 / I_{LED(DESIRE)}D$$

To set the LED current during movie mode, connect a resistor (R_{MOV}) from MOV to GND. V_{MOV} is regulated to 0.6V and the current sourced by MOV is mirrored through LED with a gain of 100. R_{MOV} is calculated as:

$$R_{MOV} = 60 / I_{LED(DESIRE)}D$$

Reservoir Capacitance vs. Current Limit

During strobe mode, the current demands on the boost converter to maintain the desired LED strobe current may cause the MAX1583 to reach the preset current limit. The MAX1583 is available with three factory-preset current limits: 250mA, 500mA, and 1A. If the current limit is reached, the internal MOSFET terminates its ON cycle early, causing the output current to drop. See the *Typical Operating Characteristics* for the Maximum Boost I_{OUT} vs. V_{IN} for each current limit. If the required strobe current exceeds the maximum boost I_{OUT} , con-

nect a reservoir capacitor from OUT to GND to provide the extra LED current. The value of this capacitor is calculated as:

$$C_{RES} = \frac{(I_{LED} - I_{BOOST}) \times t_{STROBE}}{24V - (n \times V_F)}$$

where:

I_{LED} is the desired strobe current,

I_{BOOST} is the maximum current from the boost converter obtained from the *Typical Operating Characteristics*,

t_{STROBE} is the time duration of the strobe,

n is the number of LEDs, and

V_F is the forward voltage of the LEDs.

For example, assume a minimum input voltage of 3.2V with the MAX1583Y (500mA current limit). The required strobe current is 100mA for 30ms through two series LEDs with a 4V forward voltage. The reservoir capacitor is determined as follows:

$I_{BOOST} = 75mA$ from the *Typical Operating Characteristics*.

$$C_{RES} = \frac{(100mA - 75mA) \times 30ms}{24V - (2 \times 4V)} = \frac{25mA \times 30ms}{16V} = 47\mu F$$

White LED Camera-Flash Boost Converter

MAX1583

Input-Capacitor Selection

Bypass the input to GND using a ceramic capacitor. Place the capacitor as close to the IC as possible. The exact value of the input capacitor is not critical. The typical value for the input capacitor is 22 μ F when using the MAX1583X, 10 μ F when using the MAX1583Y, and 4 μ F when using the MAX1583Z. Using these values reduces the input ripple to an acceptable level.

Output-Capacitor Selection

The output capacitance required depends on the required LED current and the time duration of the pulse in strobe mode. See the *Reservoir Capacitance vs. Current Limit* section for details on determining this capacitance value. Note that the output capacitor must be rated for 25V or greater. In addition to the reservoir capacitor, bypass the output with a 0.1 μ F, 25V capacitor from OUT to LED.

Inductor Selection

The recommended inductor values for use with the MAX1583 range from 4.7 μ H to 47 μ H. With input voltages near 5V, a larger value of inductance can be more efficient. To prevent core saturation, ensure that the inductor-saturation current rating exceeds the current limit of the MAX1583 (250mA, 500mA, or 1A).

Schottky-Diode Selection

The MAX1583 requires a high-speed rectification diode (D1) for optimum performance. A Schottky diode is recommended due to its fast recovery time and low forward-voltage drop. Ensure that the diode's average and peak current ratings exceed the average output current and the current limit (I_{LIMIT}) of the MAX1583 (250mA, 500mA, or 1A). In addition, the diode's reverse breakdown voltage must exceed V_{OUT} . The RMS diode current is calculated as:

$$I_{DIODE(RMS)} \approx \sqrt{I_{LED(MAX)} \times I_{LIMIT}}$$

Applications Information

PC Board Layout

Due to fast-switching waveforms and high-current paths, careful PC board layout is required. An evaluation kit (MAX1583EVKIT) is available as an example to speed design. When laying out a board, minimize trace lengths between the IC and the inductor, the diode, the input capacitor, and the output capacitor. Keep traces short, direct, and wide. The IN bypass capacitor should be placed as close to the IC as possible. GND should be connected directly to the exposed paddle underneath the IC. The ground connections of C_{IN} and C_{OUT} should be as close together as possible. The traces from IN to the inductor and from the Schottky diode to the LEDs can be longer.

Chip Information

TRANSISTOR COUNT: 1395

PROCESS: BiCMOS

Ordering Information

PART	TEMP RANGE	PIN-PACKAGE
MAX1583YETB-T	-40°C to +85°C	10 TDFN 3mm x 3mm
MAX1583YETB+T	-40°C to +85°C	10 TDFN 3mm x 3mm
MAX1583ZETB-T	-40°C to +85°C	10 TDFN 3mm x 3mm
MAX1583ZETB+T	-40°C to +85°C	10 TDFN 3mm x 3mm

+Denotes lead-free package.

White LED Camera-Flash Boost Converter

Package Information

(The package drawing(s) in this data sheet may not reflect the most current specifications. For the latest package outline information, go to www.maxim-ic.com/packages.)

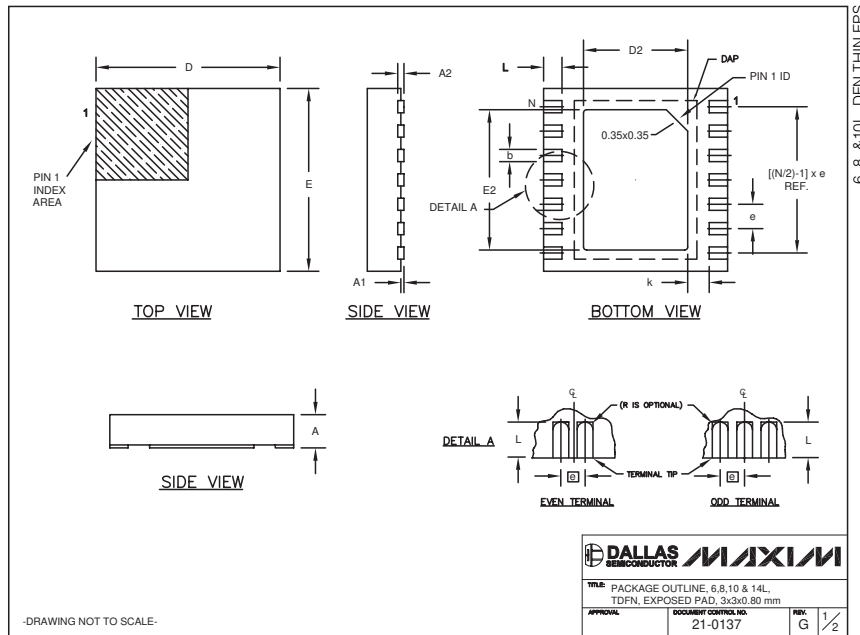

COMMON DIMENSIONS								
SYMBOL	MIN.	MAX.						
A	0.70	0.80						
D	2.90	3.10						
E	2.90	3.10						
A1	0.00	0.05						
L	0.20	0.40						
k	0.25 MIN.							
A2	0.20 REF.							

PACKAGE VARIATIONS								
PKG. CODE	N	D2	E2	e	JEDEC SPEC	b	[(N/2)-1] x e	DOWNBONDS ALLOWED
T633-1	6	1.50±0.10	2.30±0.10	0.95 BSC	MO229 / WEEA	0.40±0.05	1.90 REF	NO
T633-2	6	1.50±0.10	2.30±0.10	0.95 BSC	MO229 / WEEA	0.40±0.05	1.90 REF	NO
T833-1	8	1.50±0.10	2.30±0.10	0.65 BSC	MO229 / WEEC	0.30±0.05	1.95 REF	NO
T833-2	8	1.50±0.10	2.30±0.10	0.65 BSC	MO229 / WEEC	0.30±0.05	1.95 REF	NO
T833-3	8	1.50±0.10	2.30±0.10	0.65 BSC	MO229 / WEEC	0.30±0.05	1.95 REF	YES
T1033-1	10	1.50±0.10	2.30±0.10	0.50 BSC	MO229 / WEED-3	0.25±0.05	2.00 REF	NO
T1433-1	14	1.70±0.10	2.30±0.10	0.40 BSC	----	0.20±0.05	2.40 REF	YES
T1433-2	14	1.70±0.10	2.30±0.10	0.40 BSC	----	0.20±0.05	2.40 REF	NO

NOTES:
1. ALL DIMENSIONS ARE IN mm. ANGLES IN DEGREES.
2. COPLANARITY SHALL NOT EXCEED 0.08 mm.
3. WARPAGE SHALL NOT EXCEED 0.10 mm.
4. PACKAGE LENGTH/PACKAGE WIDTH ARE CONSIDERED AS SPECIAL CHARACTERISTIC(S).
5. DRAWING CONFORMS TO JEDEC MO229, EXCEPT DIMENSIONS "D2" AND "E2", AND T1433-1 & T1433-2.
6. "N" IS THE TOTAL NUMBER OF LEADS.
7. NUMBER OF LEADS SHOWN ARE FOR REFERENCE ONLY.

TITLE: PACKAGE OUTLINE, 6, 8, 10 & 14L, TDFN, EXPOSED PAD, 3x3x0.80 mm
APPROVAL: **DOCUMENT CONTROL NO.:** 21-0137 **REV.:** G **2/2**

-DRAWING NOT TO SCALE-

Maxim cannot assume responsibility for use of any circuitry other than circuitry entirely embodied in a Maxim product. No circuit patent licenses are implied. Maxim reserves the right to change the circuitry and specifications without notice at any time.

10 **Maxim Integrated Products, 120 San Gabriel Drive, Sunnyvale, CA 94086 408-737-7600**