



Chipsmall Limited consists of a professional team with an average of over 10 year of expertise in the distribution of electronic components. Based in Hongkong, we have already established firm and mutual-benefit business relationships with customers from,Europe,America and south Asia,supplying obsolete and hard-to-find components to meet their specific needs.

With the principle of "Quality Parts,Customers Priority,Honest Operation,and Considerate Service",our business mainly focus on the distribution of electronic components. Line cards we deal with include Microchip,ALPS,ROHM,Xilinx,Pulse,ON,Everlight and Freescale. Main products comprise IC,Modules,Potentiometer,IC Socket,Relay,Connector.Our parts cover such applications as commercial,industrial, and automotives areas.

We are looking forward to setting up business relationship with you and hope to provide you with the best service and solution. Let us make a better world for our industry!



## Contact us

Tel: +86-755-8981 8866 Fax: +86-755-8427 6832

Email & Skype: info@chipsmall.com Web: www.chipsmall.com

Address: A1208, Overseas Decoration Building, #122 Zhenhua RD., Futian, Shenzhen, China





# USB Current-Limited Switch in Pin-Compatible Package

MAX1607

## General Description

The MAX1607 is a current-limited 60mΩ switch with built-in fault blanking. Its accurate, preset 0.7A to 1.0A current limit makes it ideal for USB applications. Its low quiescent supply current (14μA) and standby current (1μA) conserve battery power in portable applications. The MAX1607 operates with inputs from +2.7V to +5.5V, making it ideal for both 3V and 5V systems.

An overcurrent signal ( $\overline{OC}$ ) notifies the microprocessor that the internal current limit has been reached. A 10ms overcurrent-blanking feature allows momentary faults (such as those caused when hot-swapping into a capacitive load) to be ignored, thus preventing false alarms to the host system. This blanking also prevents an  $\overline{OC}$  signal from being issued when the device is powering up.

The MAX1607 has several safety features to ensure that the USB port is protected. Built-in thermal-overload protection limits power dissipation and junction temperature. The device also has accurate internal current-limiting circuitry to protect the input supply against overload.

The MAX1607 is a pin-compatible upgrade to Texas Instruments' TPS2014, TPS2015, and TPS2041 for USB applications. The same die is available in a space-saving 10-pin  $\mu$ MAX<sup>®</sup> package (MAX1693) and can be used for next-generation designs. The MAX1694 is similar to the MAX1693, but it has a built-in latch that turns off the power switch in case of a long-term short-circuit condition.

The MAX1607 is also offered in a 10-pin TDFN package (not pin compatible with Texas Instruments TPS2014, TPS2015, and TPS2041 for USB applications).

## Applications

Notebook Computers      USB Hubs  
USB Ports                      Docking Stations

## Pin Configurations

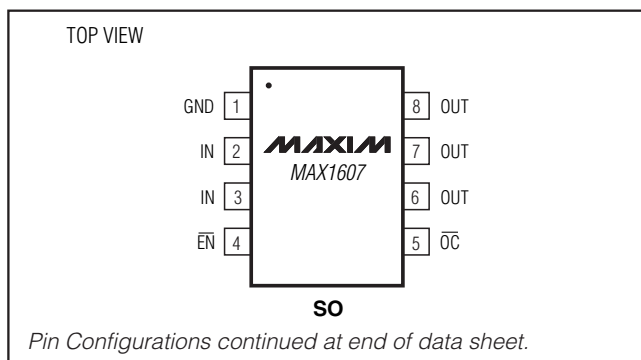

$\mu$ MAX is a registered trademark of Maxim Integrated Products, Inc.



## Features

- ◆ SO Package is Pin Compatible with TPS2014, TPS2015, and TPS2041
- ◆ Accurate Current Limit (0.7A min, 1.0A max)
- ◆ Guaranteed 0.75A Short-Circuit Protection
- ◆ 10ms Internal  $\overline{OC}$  Blanking Timeout
- ◆ No Overcurrent ( $\overline{OC}$ ) Signal During Power-Up
- ◆ 125mΩ max High-Side MOSFET
- ◆ 500mA Continuous Current
- ◆ Short-Circuit and Thermal Protection with Overcurrent Logic Output
- ◆ 1ms Start-Up Time
- ◆ Undervoltage Lockout
- ◆ 14μA Quiescent Supply Current
- ◆ 1μA max Standby Supply Current
- ◆ +2.7V to +5.5V Supply Range
- ◆ UL Recognized #E211935

## Ordering Information

PART	TEMP RANGE	PIN-PACKAGE	PKG CODE
MAX1607ESA	-40°C to +85°C	8 SO	S8-5
MAX1607ETB+	-40°C to +85°C	10 TDFN-EP*	T1033-1

\*EP = Exposed paddle.

+Denotes a lead-free package.

## Typical Operating Circuit

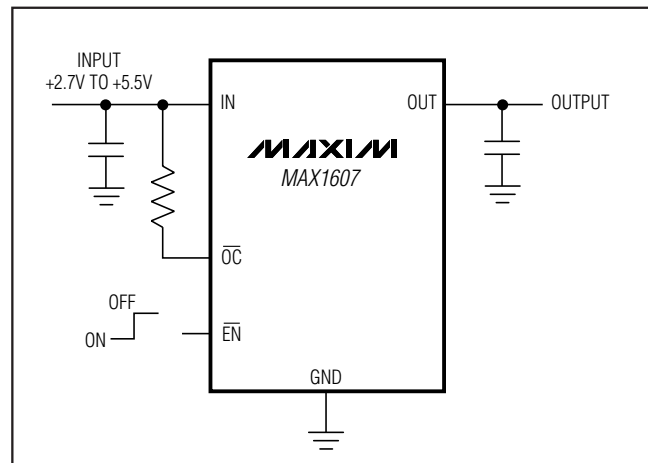

# USB Current-Limited Switch in Pin-Compatible Package

## ABSOLUTE MAXIMUM RATINGS

IN,  $\overline{\text{EN}}$ ,  $\overline{\text{OC}}$  to GND .....-0.3 to +6V  
 OUT to GND .....-0.3V to ( $V_{\text{IN}} + 0.3\text{V}$ )  
 Maximum Switch Current.....1.2A (internally limited)  
 OUT Short-Circuit to GND.....Continuous

Continuous Power Dissipation ( $T_A = +70^\circ\text{C}$ )  
 8-Pin SO (derate 5.88mW/ $^\circ\text{C}$  above  $+70^\circ\text{C}$ ).....471mW  
 10-Pin TDFN (derate 18.5mW/ $^\circ\text{C}$  above  $+70^\circ\text{C}$ ) .....1481mW  
 Operating Temperature Range (extended)..... $-40^\circ\text{C}$  to  $+85^\circ\text{C}$   
 Storage Temperature Range ..... $-65^\circ\text{C}$  to  $+150^\circ\text{C}$   
 Lead Temperature (soldering, 10s)..... $+300^\circ\text{C}$

Stresses beyond those listed under "Absolute Maximum Ratings" may cause permanent damage to the device. These are stress ratings only, and functional operation of the device at these or any other conditions beyond those indicated in the operational sections of the specifications is not implied. Exposure to absolute maximum rating conditions for extended periods may affect device reliability.

## ELECTRICAL CHARACTERISTICS

( $V_{\text{IN}} = +5\text{V}$ ,  $T_A = 0^\circ\text{C}$  to  $+85^\circ\text{C}$ , unless otherwise noted. Typical values are at  $T_A = +25^\circ\text{C}$ .) (Note 2)

PARAMETER	SYMBOL	CONDITIONS	MIN	TYP	MAX	UNITS
<b>OPERATING CONDITION</b>						
Input Voltage	$V_{\text{IN}}$		2.7		5.5	V
<b>POWER SWITCH</b>						
Switch Static Drain-Source On-State Resistance	$R_{\text{DS(ON)}}$	$T_A = +25^\circ\text{C}$	$V_{\text{IN}} = 4.4\text{V}$ to $5.5\text{V}$	60	90	m $\Omega$
		$T_A = 0^\circ\text{C}$ to $+85^\circ\text{C}$	$V_{\text{IN}} = 4.4\text{V}$ to $5.5\text{V}$		125	
			$V_{\text{IN}} = 3\text{V}$	72	150	
Switch Turn-On Time	$t_{\text{ON}}$	$I_{\text{LOAD}} = 400\text{mA}$		80	200	$\mu\text{s}$
Switch Turn-Off Time	$t_{\text{OFF}}$	$I_{\text{LOAD}} = 400\text{mA}$	3	6	20	$\mu\text{s}$
<b>ENABLE INPUT (<math>\overline{\text{EN}}</math>)</b>						
$\overline{\text{EN}}$ High-Level Input Voltage	$V_{\text{IH}}$	$V_{\text{IN}} = 2.7\text{V}$ to $3.6\text{V}$	2.0			V
		$V_{\text{IN}} = 3.7\text{V}$ to $5.5\text{V}$	2.4			
$\overline{\text{EN}}$ Low-Level Input Voltage	$V_{\text{IL}}$	$V_{\text{IN}} = 2.7\text{V}$ to $5.5\text{V}$			0.8	V
$\overline{\text{EN}}$ Input Current		$V_{\overline{\text{EN}}} = V_{\text{IN}}$ or GND	-1		+1	$\mu\text{A}$
Start-Up Time		$V_{\text{IN}} = 5\text{V}$ , $C_{\text{OUT}} = 150\mu\text{F}$ from $\overline{\text{EN}}$ driven low to 50% full $V_{\text{OUT}}$		1		ms
<b>CURRENT LIMIT</b>						
Overload Output Current	$I_{\text{LIMIT}}$	Force $V_{\text{OUT}}$ to 4.5V	700	850	1000	mA
Short-Circuit Output Current	$I_{\text{SC}}$	OUT shorted to GND		500	700	mA
<b>SUPPLY CURRENT</b>						
Supply Current, Low-Level Input		$V_{\overline{\text{EN}}} = V_{\text{IN}} = V_{\text{OUT}} = 5.5\text{V}$		0.001	1	$\mu\text{A}$
Supply Current, High-Level Input	$I_{\text{Q}}$	$V_{\overline{\text{EN}}} = \text{GND}$ , $I_{\text{OUT}} = 0$	Timer not running	14	25	$\mu\text{A}$
			Timer running	35		
Supply Leakage Current		$V_{\overline{\text{EN}}} = V_{\text{IN}} = 5.5\text{V}$ , $V_{\text{OUT}} = \text{GND}$	$T_A = +25^\circ\text{C}$	0.01	2	$\mu\text{A}$
			$T_A = 0^\circ\text{C}$ to $+85^\circ\text{C}$		15	
<b>UNDERVOLTAGE LOCKOUT</b>						
Undervoltage Lockout	UVLO	Rising edge, 100mV hysteresis	2.0	2.4	2.6	V
<b>OVERCURRENT (<math>\overline{\text{OC}}</math>)</b>						
$\overline{\text{OC}}$ Output Low Voltage	$V_{\text{OL}}$	$I_{\text{SINK}} = 1\text{mA}$ , $V_{\text{IN}} = 3\text{V}$			0.4	V
$\overline{\text{OC}}$ Off-State Current		$V_{\text{IN}} = V_{\overline{\text{OC}}} = 5\text{V}$			1	$\mu\text{A}$
$\overline{\text{OC}}$ Blanking Timeout Period	$t_{\text{BL}}$	From overcurrent condition to $\overline{\text{OC}}$ assertion	7	10	13	ms
<b>THERMAL SHUTDOWN</b>						
Thermal Shutdown Threshold				+165		$^\circ\text{C}$

# USB Current-Limited Switch in Pin-Compatible Package

MAX1607

## ELECTRICAL CHARACTERISTICS

( $V_{IN} = +5V$ ,  $T_A = -40^{\circ}C$  to  $+85^{\circ}C$ , unless otherwise noted.) (Note 1)

PARAMETER	SYMBOL	CONDITIONS	MIN	TYP	MAX	UNITS
<b>OPERATING CONDITION</b>						
Input Voltage	$V_{IN}$		3.0		5.5	V
<b>POWER SWITCH</b>						
Switch Static Drain-Source On-State Resistance	$R_{DS(ON)}$	$V_{IN} = 4.4V$ to $5.5V$			125	$m\Omega$
		$V_{IN} = 3V$			150	
Switch Turn-On Time	$t_{ON}$	$I_{LOAD} = 400mA$			200	$\mu s$
Switch Turn-Off Time	$t_{OFF}$	$I_{LOAD} = 400mA$	1		20	$\mu s$
<b>ENABLE INPUT (<math>\overline{EN}</math>)</b>						
$\overline{EN}$ High-Level Input Voltage	$V_{IH}$	$V_{IN} = 3.0V$ to $3.6V$	2.0			V
		$V_{IN} = 3.7V$ to $5.5V$	2.4			
$\overline{EN}$ Low-Level Input Voltage	$V_{IL}$	$V_{IN} = 3.0V$ to $5.5V$			0.8	V
$\overline{EN}$ Input Current		$V_{\overline{EN}} = V_{IN}$ or GND	-1		+1	$\mu A$
<b>CURRENT LIMIT</b>						
Overload Output Current	$I_{LIMIT}$	Force $V_{OUT}$ to $4.5V$	640		1060	mA
Short-Circuit Output Current	$I_{SC}$	OUT shorted to GND			750	mA
<b>SUPPLY CURRENT</b>						
Supply Current, Low-Level Input		$V_{\overline{EN}} = V_{IN} = V_{OUT} = 5.5V$			2	$\mu A$
Supply Current, High-Level Input	$I_Q$	$V_{\overline{EN}} = GND$ , $I_{OUT} = 0$ , timer not running			25	$\mu A$
Supply Leakage Current		$V_{\overline{EN}} = V_{IN} = 5.5V$ , $V_{OUT} = GND$			15	$\mu A$
<b>UNDERVOLTAGE LOCKOUT</b>						
Undervoltage Lockout	UVLO	Rising edge, 100mV hysteresis	2.0		2.9	V
<b>OVERCURRENT (<math>\overline{OC}</math>)</b>						
$\overline{OC}$ Output Low Voltage	$V_{OL}$	$I_{SINK} = 1mA$ , $V_{IN} = 3V$			0.4	V
$\overline{OC}$ Off-State Current		$V_{IN} = V_{\overline{OC}} = 5V$			1	$\mu A$
$\overline{OC}$ Blanking Timeout Period	$t_{BL}$	From overcurrent condition to $\overline{OC}$ assertion	6		14	ms

**Note 1:** Specifications to  $-40^{\circ}C$  are guaranteed by design, not production tested.

**Note 2:** TDFN package parts are 100% production tested at  $T_A = +25^{\circ}C$ . Specifications over operating temperature are guaranteed by design.

# USB Current-Limited Switch in Pin-Compatible Package

## Typical Operating Characteristics

( $V_{IN} = +5V$ ,  $T_A = +25^\circ C$ , unless otherwise noted.)

**QUIESCENT CURRENT vs. INPUT VOLTAGE**

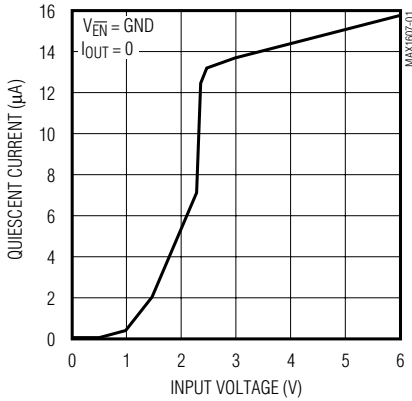

**QUIESCENT CURRENT vs. TEMPERATURE**

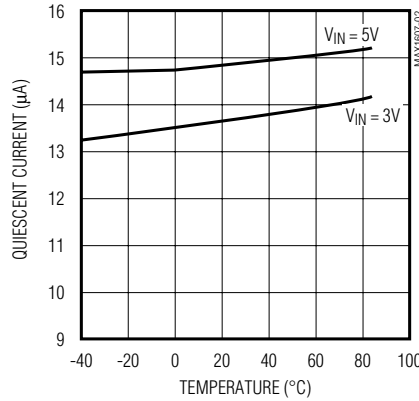

**OFF SUPPLY CURRENT vs. TEMPERATURE**

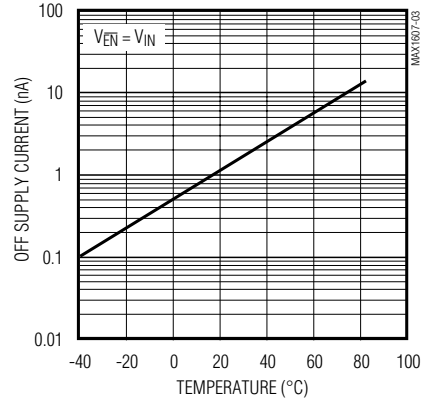

**OFF SWITCH CURRENT vs. TEMPERATURE**

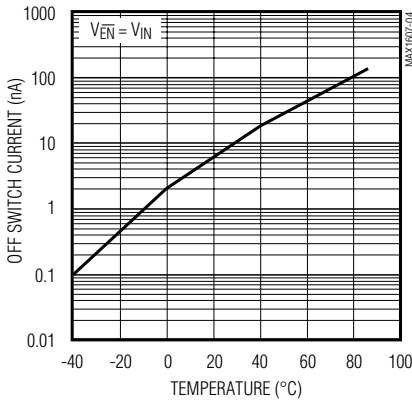

**NORMALIZED ON-RESISTANCE vs. TEMPERATURE**

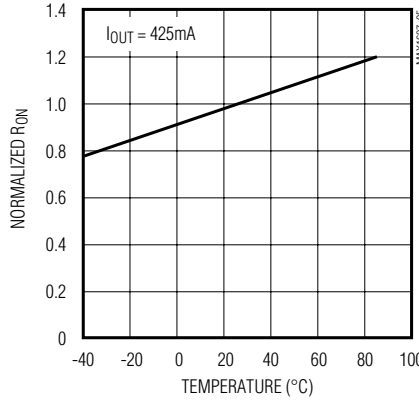

**NORMALIZED OUTPUT CURRENT vs. OUTPUT VOLTAGE**

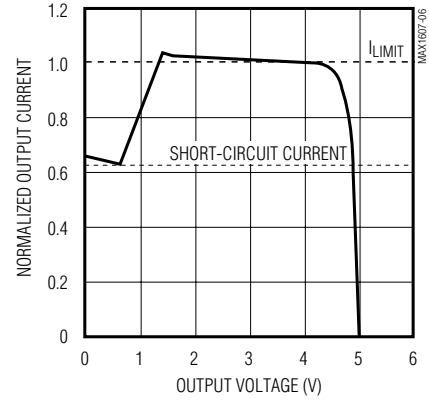

**TURN-ON TIME vs. TEMPERATURE**

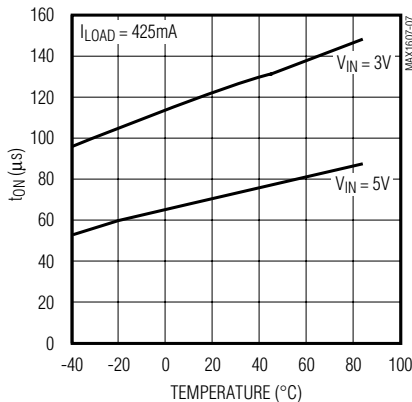

**TURN-OFF TIME vs. TEMPERATURE**

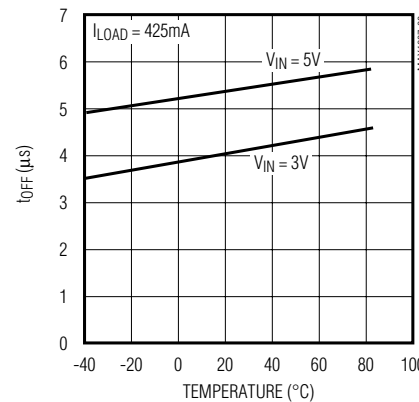

**FAULT-BLANKING TIMEOUT vs. TEMPERATURE**

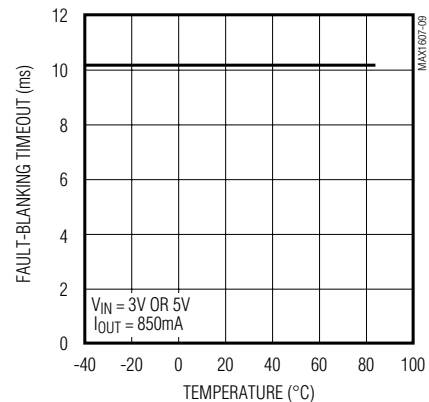

# USB Current-Limited Switch in Pin-Compatible Package

MAX1607

## Typical Operating Characteristics (continued)

( $V_{IN} = +5V$ ,  $T_A = +25^\circ C$ , unless otherwise noted.)

**CURRENT-LIMIT AND  $\overline{OC}$  RESPONSE**

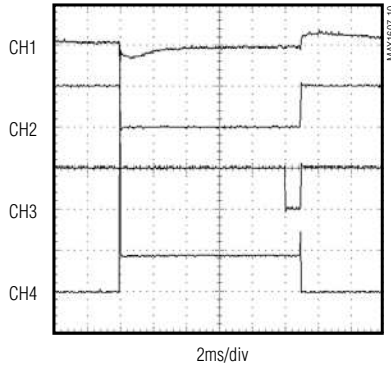

2ms/div

CH1 =  $V_{IN}$ , 200mV/div, AC-COUPLED  
CH2 =  $V_{OUT}$ , 5V/div  
CH3 =  $V_{OC}$ , 5V/div  
CH4 =  $I_{OUT}$ , 500mA/div

**CURRENT-LIMIT RESPONSE**

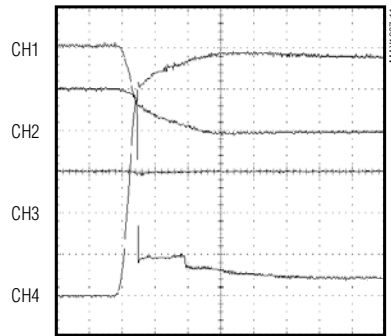

10 $\mu$ s/div

CH1 =  $V_{IN}$ , 200mV/div, AC-COUPLED  
CH2 =  $V_{OUT}$ , 5V/div  
CH3 =  $V_{OC}$ , 5V/div  
CH4 =  $I_{OUT}$ , 1A/div

**SWITCH TURN-ON TIME**

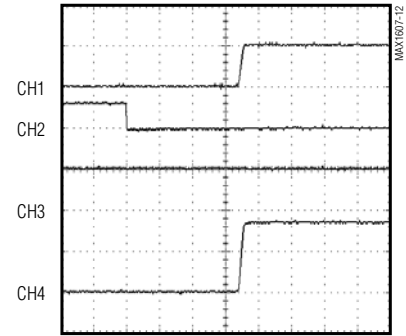

20 $\mu$ s/div

CH1 =  $V_{OUT}$ , 5V/div  
CH2 =  $V_{EN}$ , 5V/div  
CH3 =  $V_{OC}$ , 5V/div  
CH4 =  $I_{OUT}$ , 200mA/div

**SWITCH TURN-OFF TIME**

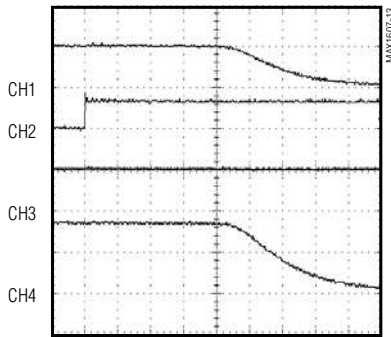

1 $\mu$ s/div

CH1 =  $V_{OUT}$ , 5V/div  
CH2 =  $V_{EN}$ , 5V/div  
CH3 =  $V_{OC}$ , 5V/div  
CH4 =  $I_{OUT}$ , 200mA/div

**START-UP TIME  
(TYPICAL USB APPLICATION)**

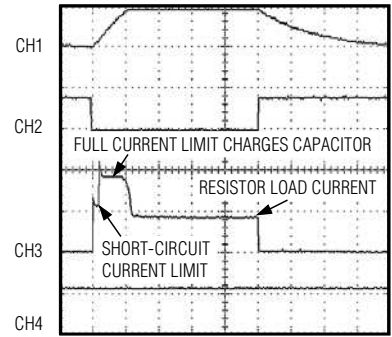

1ms/div

$V_{IN} = 5V$ ,  $R_L = 15\Omega$ ,  $C_L = 150\mu F$   
CH1 =  $V_{OUT}$ , 5V/div  
CH2 =  $V_{EN}$ , 5V/div  
CH3 =  $I_{IN}$ , 500mA/div  
CH4 =  $V_{OC}$ , 5V/div

# USB Current-Limited Switch in Pin-Compatible Package

## Pin Description

PIN		NAME	FUNCTION
SO	TDFN		
1	6	GND	Ground
2, 3	1, 3, 9	IN	Input. P-channel MOSFET source. Connect all IN pins together and bypass with a 1μF capacitor to ground.
4	5	$\overline{\text{EN}}$	Active-Low Switch Enable Input. A logic-low turns on the switch.
5	7	$\overline{\text{OC}}$	Overcurrent Indicator Output. This open-drain output goes low when the device is in thermal shutdown or undervoltage lockout, or during a sustained (> 10ms) current-limit condition.
6, 7, 8	2, 4, 8, 10	OUT	Switch Output. P-channel MOSFET drain. Connect all OUT pins together and bypass with a 0.1μF capacitor to ground.
—	—	EP	Exposed Paddle (TDFN Package Only). Internally connected to GND. Connect to a large ground plane to maximize thermal performance. Not intended as an electrical connection point.

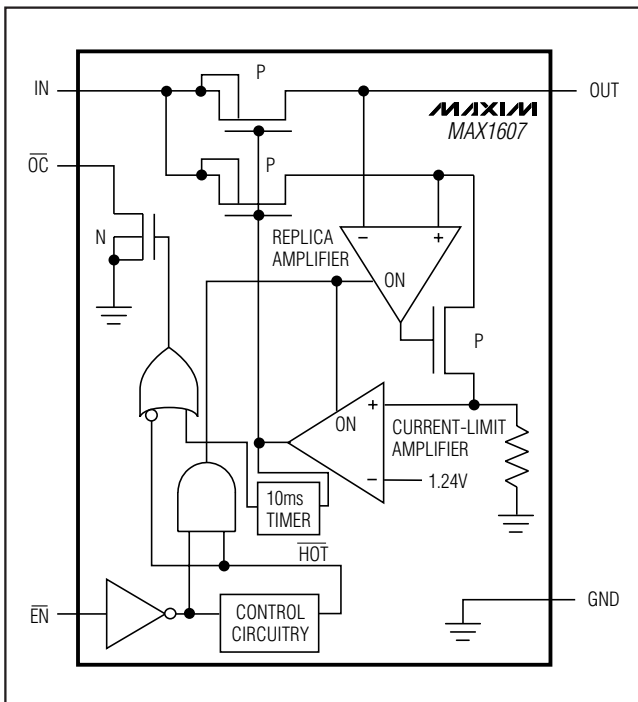

Figure 1. Functional Diagram

## Detailed Description

The MAX1607 P-channel MOSFET power switch limits output current to 0.7A min and 1.0A max. When the output current is increased beyond the current limit (LIMIT), the current also increases through the replica switch (I<sub>OUT</sub> / 6500). The current-limit error amplifier compares the voltage to the internal 1.24V reference and regulates the current back to the I<sub>LIMIT</sub> (Figure 1).

These switches are not bidirectional; therefore, the input voltage must be higher than the output voltage.

### Continuous Short-Circuit Protection

The MAX1607 is a short-circuit-protected switch. In the event of an output short-circuit condition, the current through the switch is foldback-current-limited to 500mA continuous.

### Thermal Shutdown

The MAX1607 has a thermal shutdown feature. The switch turns off and the  $\overline{\text{OC}}$  output goes low immediately (no overcurrent blanking) when the junction temperature exceeds +165°C. When the MAX1607 cools 20°C, the switch turns back on. If the fault short-circuit condition is not removed, the switch will cycle on and off, resulting in a pulsed output.

### $\overline{\text{OC}}$ Indicator

The MAX1607 provides an overcurrent output ( $\overline{\text{OC}}$ ). A 100kΩ pull-up resistor from  $\overline{\text{OC}}$  to IN provides a logic control signal. This open-drain output goes low when any of the following conditions occur:

- The input voltage is below the 2.4V undervoltage-lockout (UVLO) threshold.
- The die temperature exceeds the thermal shutdown temperature limit of +165°C.
- The device is in current limit for greater than 10ms.

### $\overline{\text{OC}}$ Blanking

The MAX1607 features 10ms overcurrent blanking. Blanking allows brief current-limit faults, including momentary short-circuit faults that occur when hot-swapping a capacitive load, and also ensures that no  $\overline{\text{OC}}$  is issued during power-up. When a load transient causes the device to enter current limit, an internal

# USB Current-Limited Switch in Pin-Compatible Package

MAX1607

counter starts. If the load fault persists beyond the 10ms overcurrent-blanking timeout, the  $\overline{OC}$  output asserts low. Ensure that the MAX1607 input is adequately bypassed to prevent input glitches from triggering spurious  $\overline{OC}$  outputs. Input voltage glitches less than 150mV will not cause a spurious  $\overline{OC}$  output. Load-transient faults less than 10ms (typ) will not cause an  $\overline{OC}$  output assertion.

Only current-limit faults are blanked. Die overtemperature faults and input voltage droops below the UVLO threshold will cause an immediate  $\overline{OC}$  output.

## Applications Information

### Input Capacitor

To limit the input voltage drop during momentary output short-circuit conditions, connect a capacitor from IN to GND. A 1 $\mu$ F ceramic capacitor will be adequate for most applications; however, higher capacitor values will further reduce the voltage drop at the input (Figure 2).

### Output Capacitor

Connect a 0.1 $\mu$ F capacitor from OUT to GND. This capacitor helps to prevent inductive parasitics from pulling OUT negative during turn-off.

### Layout and Thermal Dissipation

Important: Optimize the switch response time to output short-circuit conditions by keeping all traces as short as possible to reduce the effect of undesirable parasitic inductance. Place input and output capacitors as close as possible to the device (no more than 5mm away). All IN and OUT pins must be connected with short traces to the power bus. Wide power-bus planes will provide superior heat dissipation through the MAX1607's IN and OUT pins.

Under normal operating conditions, the package can dissipate and channel heat away. Calculate the maximum power dissipation as follows:

$$P = (I_{LIMIT})^2 \times R_{ON}$$

where  $I_{LIMIT}$  is the preset current limit (1.0A max) and  $R_{ON}$  is the on-resistance of the switch (125m $\Omega$  max).

When the output is short circuited, foldback-current limiting activates and the voltage drop across the switch equals the input supply. The power dissipated across the switch increases, as does the die temperature. If the fault condition is not removed, the thermal-overload-protection circuitry activates (see *Thermal Shutdown* section). Wide power-bus planes connected to IN and OUT and a ground plane in contact with the device will help dissipate additional heat.

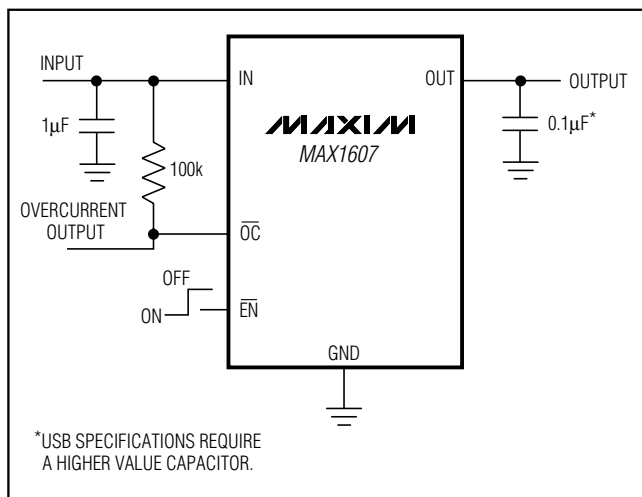
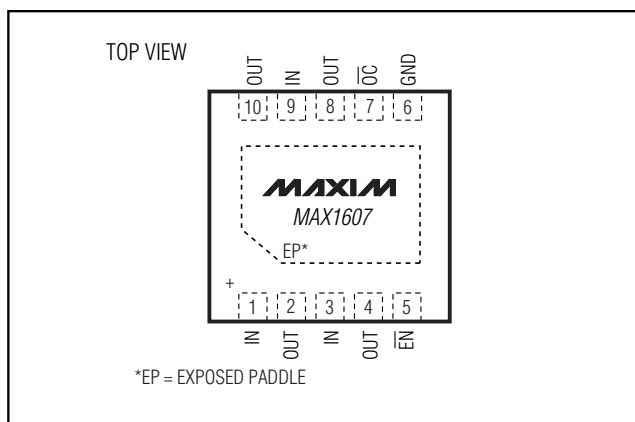

Figure 2. Typical Application Circuit

## Pin Configurations (continued)



## Chip Information

TRANSISTOR COUNT: 715



# USB Current-Limited Switch in Pin-Compatible Package

## Package Information

(The package drawing(s) in this data sheet may not reflect the most current specifications. For the latest package outline information, go to [www.maxim-ic.com/packages](http://www.maxim-ic.com/packages).)

SOICN LPS

**TOP VIEW**

**FRONT VIEW**

**SIDE VIEW**

**NOTES:**

1. D&E DO NOT INCLUDE MOLD FLASH.
2. MOLD FLASH OR PROTRUSIONS NOT TO EXCEED 0.15mm (.006").
3. LEADS TO BE COPLANAR WITHIN 0.10mm (.004").
4. CONTROLLING DIMENSION: MILLIMETERS.
5. MEETS JEDEC MS012.
6. N = NUMBER OF PINS.

DIM	INCHES		MILLIMETERS	
	MIN	MAX	MIN	MAX
A	0.053	0.069	1.35	1.75
A1	0.004	0.010	0.10	0.25
B	0.014	0.019	0.35	0.49
C	0.007	0.010	0.19	0.25
e	0.050 BSC		1.27 BSC	
E	0.150	0.157	3.80	4.00
H	0.228	0.244	5.80	6.20
L	0.016	0.050	0.40	1.27

VARIATIONS:

DIM	INCHES		MILLIMETERS		N	MS012
	MIN	MAX	MIN	MAX		
D	0.189	0.197	4.80	5.00	8	AA
D	0.337	0.344	8.55	8.75	14	AB
D	0.386	0.394	9.80	10.00	16	AC

**DALLAS SEMICONDUCTOR** **MAXIM**

PROPRIETARY INFORMATION

TITLE: PACKAGE OUTLINE, .150" SOIC

APPROVAL	DOCUMENT CONTROL NO. 21-0041	REV. B	1/1
----------	---------------------------------	-----------	-----

# USB Current-Limited Switch in Pin-Compatible Package

## Package Information (continued)

(The package drawing(s) in this data sheet may not reflect the most current specifications. For the latest package outline information, go to [www.maxim-ic.com/packages](http://www.maxim-ic.com/packages).)

**MAX1607**

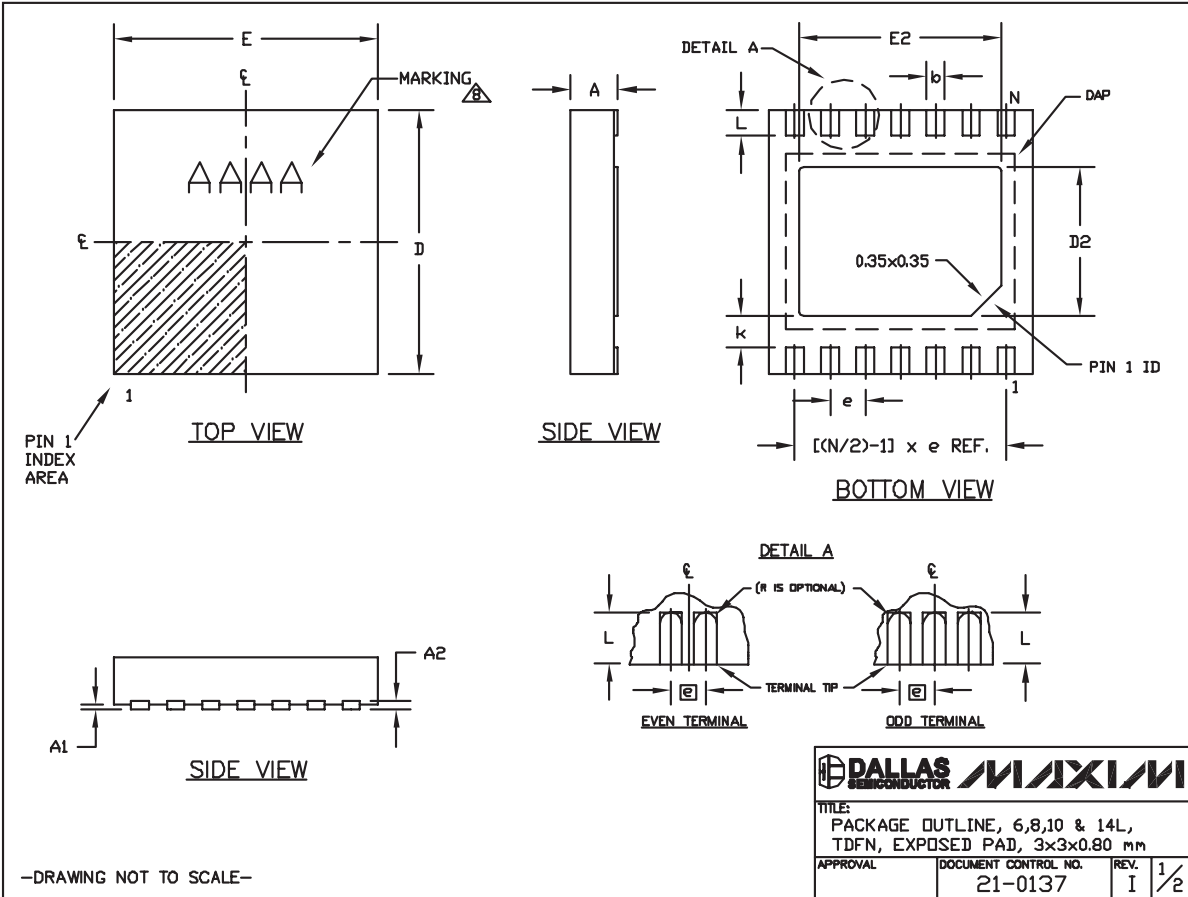

# USB Current-Limited Switch in Pin-Compatible Package

## Package Information (continued)

(The package drawing(s) in this data sheet may not reflect the most current specifications. For the latest package outline information, go to [www.maxim-ic.com/packages](http://www.maxim-ic.com/packages).)

COMMON DIMENSIONS		
SYMBOL	MIN.	MAX.
A	0.70	0.80
D	2.90	3.10
E	2.90	3.10
A1	0.00	0.05
L	0.20	0.40
k	0.25 MIN.	
A2	0.20 REF.	

PACKAGE VARIATIONS								
PKG. CODE	N	D2	E2	e	JEDEC SPEC	b	[(N/2)-1] x e	
T633-2	6	1.50±0.10	2.30±0.10	0.95 BSC	MO229 / WEEA	0.40±0.05	1.90 REF	
T833-2	8	1.50±0.10	2.30±0.10	0.65 BSC	MO229 / WEEC	0.30±0.05	1.95 REF	
T833-3	8	1.50±0.10	2.30±0.10	0.65 BSC	MO229 / WEEC	0.30±0.05	1.95 REF	
T1033-1	10	1.50±0.10	2.30±0.10	0.50 BSC	MO229 / WEED-3	0.25±0.05	2.00 REF	
T1033-2	10	1.50±0.10	2.30±0.10	0.50 BSC	MO229 / WEED-3	0.25±0.05	2.00 REF	
T1433-1	14	1.70±0.10	2.30±0.10	0.40 BSC	----	0.20±0.05	2.40 REF	
T1433-2	14	1.70±0.10	2.30±0.10	0.40 BSC	----	0.20±0.05	2.40 REF	

### NOTES:

- ALL DIMENSIONS ARE IN mm. ANGLES IN DEGREES.
- COPLANARITY SHALL NOT EXCEED 0.08 mm.
- WARPAGE SHALL NOT EXCEED 0.10 mm.
- PACKAGE LENGTH/PACKAGE WIDTH ARE CONSIDERED AS SPECIAL CHARACTERISTIC(S).
- DRAWING CONFORMS TO JEDEC MO229, EXCEPT DIMENSIONS "D2" AND "E2", AND T1433-1 & T1433-2.
- "N" IS THE TOTAL NUMBER OF LEADS.
- NUMBER OF LEADS SHOWN ARE FOR REFERENCE ONLY.
-  MARKING IS FOR PACKAGE ORIENTATION REFERENCE ONLY.

—DRAWING NOT TO SCALE—

			
<b>TITLE:</b> PACKAGE OUTLINE, 6,8,10 & 14L, TDFN, EXPOSED PAD, 3x3x0.80 mm			
APPROVAL	DOCUMENT CONTROL NO.	REV.	2/2
	21-0137	I	

## Revision History

Pages changed at Rev 2: 1, 2, 3, 6, 7–10

Maxim cannot assume responsibility for use of any circuitry other than circuitry entirely embodied in a Maxim product. No circuit patent licenses are implied. Maxim reserves the right to change the circuitry and specifications without notice at any time.

10 \_\_\_\_\_ **Maxim Integrated Products, 120 San Gabriel Drive, Sunnyvale, CA 94086 408-737-7600**