



Chipsmall Limited consists of a professional team with an average of over 10 year of expertise in the distribution of electronic components. Based in Hongkong, we have already established firm and mutual-benefit business relationships with customers from,Europe,America and south Asia,supplying obsolete and hard-to-find components to meet their specific needs.

With the principle of “Quality Parts,Customers Priority,Honest Operation,and Considerate Service”,our business mainly focus on the distribution of electronic components. Line cards we deal with include Microchip,ALPS,ROHM,Xilinx,Pulse,ON,Everlight and Freescale. Main products comprise IC,Modules,Potentiometer,IC Socket,Relay,Connector.Our parts cover such applications as commercial,industrial, and automotives areas.

We are looking forward to setting up business relationship with you and hope to provide you with the best service and solution. Let us make a better world for our industry!



Contact us

Tel: +86-755-8981 8866 Fax: +86-755-8427 6832

Email & Skype: info@chipsmall.com Web: www.chipsmall.com

Address: A1208, Overseas Decoration Building, #122 Zhenhua RD., Futian, Shenzhen, China



EVALUATION KIT
AVAILABLE

Quad-Output Controller for Low-Power Architecture

MAX17017

General Description

The MAX17017 is a quad-output controller for ultra-mobile portable computers (UMPCs) that rely on a low-power architecture. The MAX17017 provides a compact, low-cost controller capable of providing four independent regulators—a main stage, a 3Ap-p internal step-down, a 5Ap-p internal step-down, and a 2A source/sink linear regulator.

The main regulator can be configured as either a step-down converter (for 2 to 4 Li+ cell applications) or as a step-up converter (for 1 Li+ cell applications). The internal switching regulators include 5V synchronous MOSFETs that can be powered directly from a single Li+ cell or from the main 3.3V/5V power stages. Finally, the linear regulator is capable of sourcing and sinking 2A to support DDR termination requirements or to generate a fixed output voltage.

The step-down converters use a peak current-mode, fixed-frequency control scheme—an easy to implement architecture that does not sacrifice fast-transient response. This architecture also supports peak current-limit protection and pulse-skipping operation to maintain high efficiency under light-load conditions.

Separate enable inputs and independent open-drain power-good outputs allow flexible power sequencing. A soft-start function gradually ramps up the output voltage to reduce the inrush current. Disabled regulators enter high-impedance states to avoid negative output voltage created by rapidly discharging the output through the low-side MOSFET. The MAX17017 also includes output undervoltage, output overvoltage, and thermal-fault protection.

The MAX17017 is available in a 48-pin, 6mm x 6mm thin QFN package.

Applications

- 1-to-4 Li+ Cell Battery-Powered Devices
- Low-Power Architecture
- Ultra-Mobile PC (UMPC)
- Portable Gaming
- Notebook and Subnotebook Computers
- PDA's and Mobile Communicators

Features

- ◆ Fixed-Frequency, Current-Mode Controllers
- ◆ 5.5V to 28V Input Range (Step-Down) or 3V to 5V Input Range (Step-Up)
- ◆ 1x Step-Up or Step-Down Controller
- ◆ 1x Internal 5Ap-p Step-Down Regulator
- ◆ 1x Internal 3Ap-p Step-Down Regulator
- ◆ 1x 2A Source/Sink Linear Regulator with Dynamic REFIN
- ◆ Internal BST Diodes
- ◆ Internal 5V, 50mA Linear Regulator
- ◆ Fault Protection—Undervoltage, Overvoltage, Thermal, Peak Current Limit
- ◆ Independent Enable Inputs and Power-Good Outputs
- ◆ Voltage-Controlled Soft-Start
- ◆ High-Impedance Shutdown
- ◆ 10 μ A (typ) Shutdown Current

Ordering Information

PART	TEMP RANGE	PIN-PACKAGE
MAX17017GTM+	-40°C to +105°C	48 TQFN-EP*

+ Denotes a lead(Pb)-free/RoHS-compliant package.

*EP = Exposed pad.

Pin Configuration

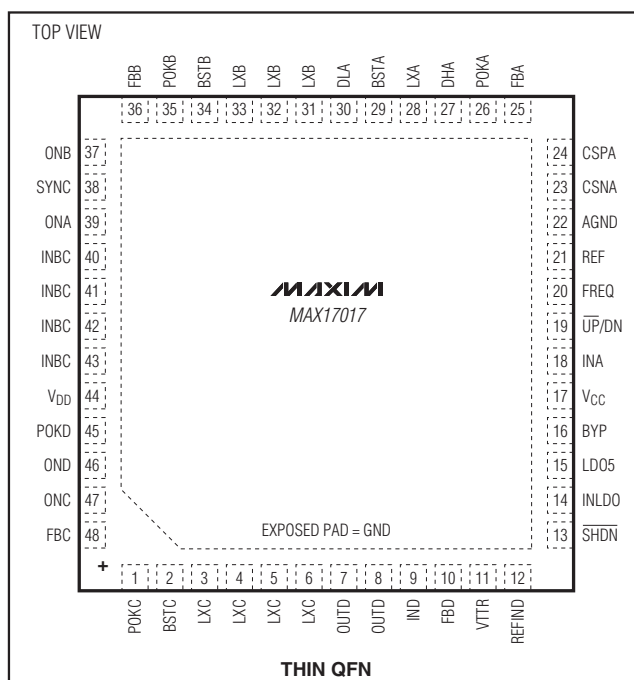

Quad-Output Controller for Low-Power Architecture

ABSOLUTE MAXIMUM RATINGS

INLDO, $\overline{\text{SHDN}}$ to GND	-0.3V to +28V
LDO5, INA, V_{DD} , V_{CC} to GND	-0.3V to +6V
DHA to LXA	-0.3V to ($V_{\text{BSTA}} + 0.3\text{V}$)
ONA, ONB, ONC, OND to GND	-0.3V to +6V
POKA, POKB, POKC, POKD to GND	-0.3V to ($V_{\text{CC}} + 0.3\text{V}$)
REF, REFIND, FREQ, $\overline{\text{UP/DN}}$, SYNC to GND	-0.3V to ($V_{\text{CC}} + 0.3\text{V}$)
FBA, FBB, FBC, FBD to GND	-0.3V to ($V_{\text{CC}} + 0.3\text{V}$)
BYP to GND	-0.3V to ($V_{\text{LDO5}} + 0.3\text{V}$)
CSPA, CSNA to GND	-0.3V to ($V_{\text{CC}} + 0.3\text{V}$)
DLA to GND	-0.3V to ($V_{\text{DD}} + 0.3\text{V}$)
INBC, IND to GND	-0.3V to +6V
OUTD to GND	-0.3V to ($V_{\text{IND}} + 0.3\text{V}$)

VTTR to GND	-0.3V to ($V_{\text{BYP}} + 0.3\text{V}$)
LXB, LXC to GND	-1.0V to ($V_{\text{INBC}} + 0.3\text{V}$)
BSTB to GND	($V_{\text{DD}} - 0.3\text{V}$) to ($V_{\text{LXB}} + 6\text{V}$)
BSTC to GND	($V_{\text{DD}} - 0.3\text{V}$) to ($V_{\text{LXC}} + 6\text{V}$)
BSTA to GND	($V_{\text{DD}} - 0.3\text{V}$) to ($V_{\text{LXA}} + 6\text{V}$)
REF Short-Circuit Current	1mA
Continuous Power Dissipation ($T_{\text{A}} = +70^{\circ}\text{C}$)	
Multilayer PCB: 48-Pin 6mm x 6mm ² TQFN	
(T4866-2 derated 37mW/ $^{\circ}\text{C}$ above $+70^{\circ}\text{C}$)	2.9W
Operating Temperature Range	-40 $^{\circ}\text{C}$ to +105 $^{\circ}\text{C}$
Junction Temperature	+150 $^{\circ}\text{C}$
Storage Temperature Range	-65 $^{\circ}\text{C}$ to +150 $^{\circ}\text{C}$
Lead Temperature (soldering, 10s)	+300 $^{\circ}\text{C}$

Stresses beyond those listed under "Absolute Maximum Ratings" may cause permanent damage to the device. These are stress ratings only, and functional operation of the device at these or any other conditions beyond those indicated in the operational sections of the specifications is not implied. Exposure to absolute maximum rating conditions for extended periods may affect device reliability.

ELECTRICAL CHARACTERISTICS

(Circuit of Figure 1 (step-down), $V_{\text{INLDO}} = 12\text{V}$, $V_{\text{INA}} = V_{\text{INBC}} = V_{\text{DD}} = V_{\text{CC}} = V_{\text{BYP}} = V_{\text{CSPA}} = V_{\text{CSNA}} = 5\text{V}$, $V_{\text{IND}} = 1.8\text{V}$, $V_{\overline{\text{SHDN}}} = V_{\text{ONA}} = V_{\text{ONB}} = V_{\text{ONC}} = V_{\text{OND}} = 5\text{V}$, $I_{\text{REF}} = I_{\text{LDO5}} = I_{\text{OUTD}} = \text{no load}$, FREQ = GND, $\overline{\text{UP/DN}} = V_{\text{CC}}$, $T_{\text{A}} = 0^{\circ}\text{C}$ to $+85^{\circ}\text{C}$, unless otherwise noted. Typical values are at $T_{\text{A}} = +25^{\circ}\text{C}$.) (Note 1)

PARAMETER	SYMBOL	CONDITIONS	$T_{\text{A}} = 0^{\circ}\text{C}$ to $+85^{\circ}\text{C}$			UNITS
			MIN	TYP	MAX	
Input Voltage Range		$\overline{\text{UP/DN}} = \text{GND}$ (step-up), INA	3.0		5.0	V
		$\overline{\text{UP/DN}} = \text{LDO5}$ (step-down), INLDO, INA = LDO5	5.5		24	
INA Undervoltage Threshold	$V_{\text{INA(UVLO)}}$	$\overline{\text{UP/DN}} = \text{GND}$ (step-up), INA = INLDO, rising edge hysteresis = 100mV	2.5	2.7	2.9	V
		$\overline{\text{UP/DN}} = \text{LDO5}$ (step-down), INA = V_{CC} , rising edge, hysteresis = 160mV	4.0	4.2	4.4	
INBC Input Voltage Range			2.3		5.5	V
Minimum Step-Up Startup Voltage		$\overline{\text{UP/DN}} = \text{GND}$ (step-up)	2.9	3.0		V
SUPPLY CURRENTS						
V_{INLDO} Shutdown Supply Current	$I_{\text{IN}(\overline{\text{SHDN}})}$	$V_{\text{IN}} = 5.5\text{V}$ to 26V , $\overline{\text{SHDN}} = \text{GND}$		10	15	μA
V_{INLDO} Suspend Supply Current	$I_{\text{IN}(\text{SUS})}$	$V_{\text{INLDO}} = 5.5\text{V}$ to 26V , $\text{ON}_- = \text{GND}$, $\overline{\text{SHDN}} = \text{INLDO}$		50	80	μA
V_{CC} Shutdown Supply Current		$\overline{\text{SHDN}} = \text{ONA} = \text{ONB} = \text{ONC} = \text{OND} = \text{GND}$, $T_{\text{A}} = +25^{\circ}\text{C}$		0.1	1	μA
V_{DD} Shutdown Supply Current		$\overline{\text{SHDN}} = \text{ONA} = \text{ONB} = \text{ONC} = \text{OND} = \text{GND}$, $T_{\text{A}} = +25^{\circ}\text{C}$		0.1	1	μA
INA Shutdown Current	I_{INA}	$\overline{\text{SHDN}} = \text{ONA} = \text{ONB} = \text{ONC} = \text{OND} = \text{GND}$, $\overline{\text{UP/DN}} = V_{\text{CC}}$		7	10	μA
V_{CC} Supply Current Main Step-Down Only		ONA = V_{CC} , ONB = ONC = OND = GND; does not include switching losses, measured from V_{CC}		210	300	μA

Quad-Output Controller for Low-Power Architecture

MAX17017

ELECTRICAL CHARACTERISTICS (continued)

(Circuit of Figure 1 (step-down), $V_{INLDO} = 12V$, $V_{INA} = V_{INBC} = V_{DD} = V_{CC} = V_{BYP} = V_{CSPA} = V_{CSNA} = 5V$, $V_{IND} = 1.8V$, $V_{SHDN} = V_{ONA} = V_{ONB} = V_{ONC} = V_{OND} = 5V$, $I_{REF} = I_{LDO5} = I_{OUTD} =$ no load, $FREQ = GND$, $\overline{UP/DN} = V_{CC}$, $T_A = 0^{\circ}C$ to $+85^{\circ}C$, unless otherwise noted. Typical values are at $T_A = +25^{\circ}C$.) (Note 1)

PARAMETER	SYMBOL	CONDITIONS	$T_A = 0^{\circ}C$ to $+85^{\circ}C$			UNITS
			MIN	TYP	MAX	
V _{CC} Supply Current Main Step-Down and Regulator B		ON _A = ON _B = V _{CC} , ON _C = ON _D = GND; does not include switching losses, measured from V _{CC}		280	350	μA
V _{CC} Supply Current Main Step-Down and Regulator C		ON _A = ON _C = V _{CC} , ON _B = ON _D = GND; does not include switching losses, measured from V _{CC}		280	350	μA
V _{CC} Supply Current Main Step-Down and Regulator D		ON _A = ON _D = V _{CC} , ON _B = ON _C = GND; does not include switching losses; measured from V _{CC}		2.2	3	mA
INA Supply Current (Step-Down)	I _{INA}	ON _A = V _{CC} , $\overline{UP/DN} = V_{CC}$ (step-down)		40	60	μA
INA + V _{CC} Step-Up Supply Current	I _{INA}	ON _A = V _{CC} , $\overline{UP/DN} = GND$ (step-up)		320	410	μA
5V LINEAR REGULATOR (LDO5)						
LDO5 Output Voltage	V _{LDO5}	V _{INLDO} = 5.5V to 26V, I _{LDO5} = 0 to 50mA, BYP = GND	4.8	5.0	5.2	V
LDO5 Short-Circuit Current Limit		LDO5 = BYP = GND	70	160	250	mA
BYP Switchover Threshold	V _{BYP}	Rising edge		4.65		V
LDO5-to-BYP Switch Resistance	R _{BYP}	LDO5 to BYP, V _{BYP} = 5V, I _{LDO5} = 50mA		1.5	4	—
1.25V REFERENCE						
Reference Output Voltage	V _{REF}	No load	1.237	1.25	1.263	V
Reference Load Regulation	ΔV_{REF}	I _{REF} = -1μA to +50μA		3	10	mV
Reference Undervoltage Lockout	V _{REF(UVLO)}			1.0		V
OSCILLATOR						
Oscillator Frequency	f _{OSC}	FREQ = V _{CC}		500		kHz
		FREQ = REF		750		
		FREQ = GND	0.9	1.0	1.1	MHz
Switching Frequency	f _{SWA}	Main step-up/step-down (regulator A)		1/2 f _{OSC}		MHz
	f _{SWB}	Regulator B		f _{OSC}		
	f _{SWC}	Regulator C		1/2 f _{OSC}		
Maximum Duty Cycle (All Switching Regulators)	D _{MAX}		90	93.5		%
Minimum On-Time (All Switching Regulators)	t _{ON(MIN)}	FREQ = V _{CC} or GND		90		ns
		FREQ = REF		75		
REGULATOR A (Main Step-Up/Step-Down)						
Output-Voltage Adjust Range		Step-up configuration ($\overline{UP/DN} = GND$)	3.0		V _{CC} + 0.3	V
		Step-down configuration ($\overline{UP/DN} = V_{CC}$)	1.0		V _{CC} + 0.3	

Quad-Output Controller for Low-Power Architecture

ELECTRICAL CHARACTERISTICS (continued)

(Circuit of Figure 1 (step-down), $V_{INLDO} = 12V$, $V_{INA} = V_{INBC} = V_{DD} = V_{CC} = V_{BYP} = V_{CSPA} = V_{CSNA} = 5V$, $V_{IND} = 1.8V$, $V_{SHDN} = V_{ONA} = V_{ONB} = V_{ONC} = V_{OND} = 5V$, $I_{REF} = I_{LDO5} = I_{OUTD} = \text{no load}$, $FREQ = GND$, $\overline{UP}/DN = V_{CC}$, $T_A = 0^\circ\text{C to } +85^\circ\text{C}$, unless otherwise noted. Typical values are at $T_A = +25^\circ\text{C}$.) (Note 1)

PARAMETER	SYMBOL	CONDITIONS	$T_A = 0^\circ\text{C to } +85^\circ\text{C}$			UNITS
			MIN	TYP	MAX	
FBA Regulation Voltage	V_{FBA}	Step-up configuration ($\overline{UP}/DN = GND$), $V_{CSPA} - V_{CSNA} = 0$ to 20mV, 90% duty cycle	0.975	0.99	1.013	V
		Step-down configuration ($\overline{UP}/DN = V_{CC}$), $V_{CSPA} - V_{CSNA} = 0$ mV, 90% duty cycle	0.968	0.97	1.003	
FBA Regulation Voltage (Overload)	V_{FBA}	Step-up configuration ($\overline{UP}/DN = GND$), $V_{CSPA} - V_{CSNA} = 0$ mV, 90% duty cycle	0.959		1.013	V
		Step-down configuration ($\overline{UP}/DN = V_{CC}$), $V_{CSPA} - V_{CSNA} = 0$ to 20mV, 90% duty cycle	0.930		1.003	
FBA Load Regulation	ΔV_{FBA}	Step-up configuration ($\overline{UP}/DN = GND$), $V_{CSPA} - V_{CSNA} = 0$ to 20mV		-20		mV
		Step-down configuration ($\overline{UP}/DN = V_{CC}$), $V_{CSPA} - V_{CSNA} = 0$ to 20mV		-40		
FBA Line Regulation		$\overline{UP}/DN = GND$ or V_{CC} , 0 to 100% duty cycle				mV
		Step-up ($\overline{UP}/DN = GND$)	5	10	16	
		Step-down ($\overline{UP}/DN = V_{CC}$)	10	16	22	
FBA Input Current	I_{FBA}	$\overline{UP}/DN = GND$ or V_{CC} , $T_A = +25^\circ\text{C}$	-100	-5	+100	nA
Current-Sense Input Common-Mode Range	V_{CSA}		0		$V_{CC} + 0.3V$	V
Current-Sense Input Bias Current	I_{CSA}	$T_A = +25^\circ\text{C}$		40	60	μA
Current-Limit Threshold (Positive)	V_{ILIMA}		18	20	22	mV
Idle Mode™ Threshold	V_{IDLEA}			4		mV
Zero-Crossing Threshold	V_{IZX}			1		mV
DHA Gate Driver On-Resistance	R_{DH}	DHA forced high and low		2.5	5	Ω
DLA Gate Driver On-Resistance	R_{DL}	DLA forced high		2.5	5	Ω
		DLA forced low		1.5	3	
DHA Gate Driver Source/Sink Current	I_{DH}	DHA forced to 2.5V		0.7		A
DLA Gate Driver Source/Sink Current	$I_{DL(SRC)}$	DLA forced to 2.5V		0.7		A
	$I_{DL(SNK)}$	DLA forced to 2.5V		1.5		
BSTA Switch On-Resistance	R_{BSTA}			5		Ω

Idle Mode is a trademark of Maxim Integrated Products, Inc.

Quad-Output Controller for Low-Power Architecture

MAX17017

ELECTRICAL CHARACTERISTICS (continued)

(Circuit of Figure 1 (step-down), $V_{INLDO} = 12V$, $V_{INA} = V_{INBC} = V_{DD} = V_{CC} = V_{BYP} = V_{CSPA} = V_{CSNA} = 5V$, $V_{IND} = 1.8V$, $V_{SHDN} = V_{ONA} = V_{ONB} = V_{ONC} = V_{OND} = 5V$, $I_{REF} = I_{LDO5} = I_{OUTD} =$ no load, $FREQ = GND$, $UP/DN = V_{CC}$, $T_A = 0^{\circ}C$ to $+85^{\circ}C$, unless otherwise noted. Typical values are at $T_A = +25^{\circ}C$.) (Note 1)

PARAMETER	SYMBOL	CONDITIONS	$T_A = 0^{\circ}C$ to $+85^{\circ}C$			UNITS
			MIN	TYP	MAX	
REGULATOR B (Internal 3A Step-Down Converter)						
FBB Regulation Voltage		$I_{LXB} = 0\%$ duty cycle (Note 2)	0.747	0.755	0.762	V
FBB Regulation Voltage (Overload)	V_{FBB}	$I_{LXB} = 0$ to 2.5A, 0% duty cycle (Note 2)	0.720		0.762	V
FBB Load Regulation	$\Delta V_{FBB}/\Delta I_{LXB}$	$I_{LXB} = 0$ to 2.5A		-5		mV/A
FBB Line Regulation		0 to 100% duty cycle	7	8	10	mV
FBB Input Current	I_{FBB}	$T_A = +25^{\circ}C$	-100	-5	+100	nA
Internal MOSFET On-Resistance		High-side n-channel		75	150	m Ω
		Low-side n-channel		40	80	
LXB Peak Current Limit	I_{PKB}		3.0	3.45	4.0	A
LXB Idle-Mode Trip Level	I_{IDLEB}			0.8		A
LXB Zero-Crossing Trip Level	I_{ZXB}			100		mA
LXB Leakage Current	I_{LXB}	$ONB = GND$, $V_{LXB} = GND$ or 5V; $V_{INBC} = 5V$ at $T_A = +25^{\circ}C$	-20		+20	μ A
REGULATOR C (Internal 5A Step-Down Converter)						
FBC Regulation Voltage		$I_{LXC} = 0A$, 0% duty cycle (Note 2)	0.747	0.755	0.762	V
FBC Regulation Voltage (Overload)	V_{FBC}	$I_{LXC} = 0$ to 4A, 0% duty cycle (Note 2)	0.710		0.762	V
FBC Load Regulation	$\Delta V_{FBC}/\Delta I_{LXC}$	$I_{LXC} = 0$ to 4A		-7		mV/A
FBC Line Regulation		0 to 100% duty cycle	12	14	16	mV
FBC Input Current	I_{FBC}	$T_A = +25^{\circ}C$	-100	-5	+100	nA
Internal MOSFET On-Resistance		High-side n-channel		50	100	m Ω
		Low-side n-channel		25	40	
LXC Peak Current Limit	I_{PKC}		5.0	5.75	6.5	A
LXC Idle-Mode Trip Level	I_{IDLEC}			1.2		A
LXC Zero-Crossing Trip Level	I_{ZXC}			100		mA
LXC Leakage Current	I_{LXC}	$ONC = GND$, $V_{LXC} = GND$ or 5V; $V_{INBC} = 5V$ at $T_A = +25^{\circ}C$	-20		+20	μ A
REGULATOR D (Source/Sink Linear Regulator and VTTR Buffer)						
IND Input Voltage Range	V_{IND}		1		2.8	V
IND Supply Current		$OND = V_{CC}$		10	50	μ A
IND Shutdown Current		$OND = GND$, $T_A = +25^{\circ}C$			10	μ A
REFIND Input Range			0.5		1.5	V
REFIND Input Bias Current		$V_{REFIND} = 0$ to 1.5V, $T_A = +25^{\circ}C$	-100		+100	nA
OUTD Output Voltage Range	V_{OUTD}		0.5		1.5	V
FBD Output Accuracy	V_{FBD}	V_{FBD} with respect to V_{REFIND} , $OUTD = FBD$, $I_{OUTD} = +50\mu A$ (source load)	-10		0	mV
		V_{FBD} with respect to V_{REFIND} , $OUTD = FBD$, $I_{OUTD} = -50\mu A$ (sink load)	0		+10	
FBD Load Regulation		$I_{OUTD} = \pm 1A$	-17	-13		mV/A

Quad-Output Controller for Low-Power Architecture

ELECTRICAL CHARACTERISTICS (continued)

(Circuit of Figure 1 (step-down), $V_{INLDO} = 12V$, $V_{INA} = V_{INBC} = V_{DD} = V_{CC} = V_{BYP} = V_{CSPA} = V_{CSNA} = 5V$, $V_{IND} = 1.8V$, $V_{SHDN} = V_{ONA} = V_{ONB} = V_{ONC} = V_{OND} = 5V$, $I_{REF} = I_{LDO5} = I_{OUTD} =$ no load, $FREQ = GND$, $\overline{UP/DN} = V_{CC}$, $T_A = 0^{\circ}C$ to $+85^{\circ}C$, unless otherwise noted. Typical values are at $T_A = +25^{\circ}C$.) (Note 1)

PARAMETER	SYMBOL	CONDITIONS	$T_A = 0^{\circ}C$ to $+85^{\circ}C$			UNITS
			MIN	TYP	MAX	
FBD Line Regulation		$V_{IND} = 1.0V$ to $2.8V$, $I_{OUTD} = \pm 200mA$	1			mV
FBD Input Current		$V_{FBD} = 0$ to $1.5V$, $T_A = +25^{\circ}C$	0.1	0.5		μA
OUTD Linear Regulator Current Limit		Source load	+2		+4	A
		Sink load	-2		-4	
Current-Limit Soft-Start Time		With respect to internal OND signal	160			μs
Internal MOSFET On-Resistance		High-side on-resistance	120	250		m Ω
		Low-side on-resistance	180	450		
VTTR Output Accuracy		REFIND to VTTR	$I_{VTTR} = \pm 0.5mA$	-10	+10	mV
			$I_{VTTR} = \pm 3mA$	-20	+20	
VTTR Maximum Current Rating			± 5			mA
FAULT PROTECTION						
SMPS POK and Fault Thresholds		Upper threshold rising edge, hysteresis = 50mV	9	12	14	%
		Lower threshold falling edge, hysteresis = 50mV	-14	-12	-9	
VTT LDO POKD and Fault Threshold		Upper threshold rising edge, hysteresis = 50mV	6	12	16	%
		Lower threshold falling edge, hysteresis = 50mV	-16	-12	-6	
POK Propagation Delay	t_{POK}	FB_ forced 50mV beyond POK_ trip threshold	5			μs
Overvoltage Fault Latch Delay	t_{OVP}	FB_ forced 50mV above POK_ upper trip threshold	5			μs
SMPS Undervoltage Fault Latch Delay	t_{UVP}	FBA, FBB, or FBC forced 50mV below POK_ lower trip threshold	5			μs
VTT LDO Undervoltage Fault Latch Delay	t_{UVP}	FBD forced 50mV below POKD lower trip threshold	5000			μs
POK Output Low Voltage	V_{POK}	$I_{SINK} = 3mA$	0.4			V
POK Leakage Currents	I_{POK}	$V_{FBA} = 1.05V$, $V_{FBB} = V_{FBC} = 0.8V$, $V_{FBD} = V_{REFIND} + 50mV$ (POK high impedance); POK_ forced to 5V, $T_A = +25^{\circ}C$	1			μA
Thermal-Shutdown Threshold	T_{SHDN}	Hysteresis = 15 $^{\circ}C$	160			$^{\circ}C$
GENERAL LOGIC LEVELS						
\overline{SHDN} Input Logic Threshold		Hysteresis = 20mV	0.5	1.6		V
\overline{SHDN} Input Bias Current		$T_A = +25^{\circ}C$	-1	+1		μA
ON_ Input Logic Threshold		Hysteresis = 170mV	0.5	1.6		V
ON_ Input Bias Current		$T_A = +25^{\circ}C$	-1	+1		μA
$\overline{UP/DN}$ Input Logic Threshold			0.5	1.6		V
$\overline{UP/DN}$ Input Bias Current		$T_A = +25^{\circ}C$	-1	+1		μA

Quad-Output Controller for Low-Power Architecture

MAX17017

ELECTRICAL CHARACTERISTICS (continued)

(Circuit of Figure 1 (step-down), $V_{INLDO} = 12V$, $V_{INA} = V_{INBC} = V_{DD} = V_{CC} = V_{BYP} = V_{CSPA} = V_{CSNA} = 5V$, $V_{IND} = 1.8V$, $\overline{VSHDN} = V_{ONA} = V_{ONB} = V_{ONC} = V_{OND} = 5V$, $I_{REF} = I_{LDO5} = I_{OUTD} =$ no load, $FREQ = GND$, $\overline{UP/DN} = V_{CC}$, $T_A = 0^{\circ}C$ to $+85^{\circ}C$, unless otherwise noted. Typical values are at $T_A = +25^{\circ}C$.) (Note 1)

PARAMETER	SYMBOL	CONDITIONS	$T_A = 0^{\circ}C$ to $+85^{\circ}C$			UNITS
			MIN	TYP	MAX	
FREQ Input Voltage Levels		High (V_{CC})	$V_{CC} - 0.4V$			V
		Unconnected/REF	1.65		3.8	
		Low (GND)			0.5	
FREQ Input Bias Current		$T_A = +25^{\circ}C$	-2		+2	μA
SYNC Input Logic Threshold			1.5		3.5	V
SYNC Input Bias Current		$T_A = +25^{\circ}C$	-1		+1	μA

ELECTRICAL CHARACTERISTICS

(Circuit of Figure 1 (step-down), $V_{INLDO} = 12V$, $V_{INA} = V_{INBC} = V_{DD} = V_{CC} = V_{BYP} = V_{CSPA} = V_{CSNA} = 5V$, $V_{IND} = 1.8V$, $\overline{VSHDN} = V_{ONA} = V_{ONB} = V_{ONC} = V_{OND} = 5V$, $I_{REF} = I_{LDO5} = I_{OUTD} =$ no load, $FREQ = GND$, $\overline{UP/DN} = V_{CC}$, $T_A = -40^{\circ}C$ to $+105^{\circ}C$.) (Note 1)

PARAMETER	SYMBOL	CONDITIONS	$T_A = -40^{\circ}C$ to $+105^{\circ}C$			UNITS
			MIN	TYP	MAX	
Input Voltage Range		$\overline{UP/DN} = GND$ (step-up), INA	3.0		5.0	V
		$\overline{UP/DN} = LDO5$ (step-down), INLDO, INA = LDO5	5.5		24	
INA Undervoltage Threshold	$V_{INA(UVLO)}$	$\overline{UP/DN} = GND$ (step-up), INA = INLDO, rising edge, hysteresis = 100mV	2.4		3.0	V
		$\overline{UP/DN} = LDO5$ (step-down), INA = V_{CC} , rising edge, hysteresis = 160mV	3.9		4.5	
INBC Input Voltage Range			2.3		5.5	V
Minimum Step-Up Startup Voltage		$\overline{UP/DN} = GND$ (step-up)	3.0			V
SUPPLY CURRENTS						
V_{INLDO} Shutdown Supply Current	$I_{IN(\overline{SHDN})}$	$V_{IN} = 5.5V$ to $26V$, $\overline{SHDN} = GND$			15	μA
V_{INLDO} Suspend Supply Current	$I_{IN(SUS)}$	$V_{INLDO} = 5.5V$ to $26V$, $ON_+ = GND$, $\overline{SHDN} = INLDO$			80	μA
INA Shutdown Current	I_{INA}	$\overline{SHDN} = ONA = ONB = ONC = OND = GND$, $\overline{UP/DN} = V_{CC}$			10	μA
V_{CC} Supply Current Main Step-Down Only		$ON_A = V_{CC}$, $ON_B = ONC = OND = GND$; does not include switching losses, measured from V_{CC}			350	μA
V_{CC} Supply Current Main Step-Down and Regulator B		$ON_A = ONB = V_{CC}$, $ONC = OND = GND$; does not include switching losses, measured from V_{CC}			400	μA
V_{CC} Supply Current Main Step-Down and Regulator C		$ON_A = ONC = V_{CC}$, $ONB = OND = GND$, does not include switching losses, measured from V_{CC}			400	μA

Quad-Output Controller for Low-Power Architecture

ELECTRICAL CHARACTERISTICS (continued)

(Circuit of Figure 1 (step-down), $V_{INLDO} = 12V$, $V_{INA} = V_{INBC} = V_{DD} = V_{CC} = V_{BYP} = V_{CSPA} = V_{CSNA} = 5V$, $V_{IND} = 1.8V$, $V_{SHDN} = V_{ONA} = V_{ONB} = V_{ONC} = V_{OND} = 5V$, $I_{REF} = I_{LDO5} = I_{OUTD} = \text{no load}$, $FREQ = GND$, $\overline{UP}/DN = V_{CC}$, $T_A = -40^{\circ}C \text{ to } +105^{\circ}C$.) (Note 1)

PARAMETER	SYMBOL	CONDITIONS	$T_A = -40^{\circ}C \text{ to } +105^{\circ}C$			UNITS
			MIN	TYP	MAX	
V _{CC} Supply Current Main Step-Down and Regulator D		ONA = OND = V _{CC} , ONB = ONC = GND, does not include switching losses, measured from V _{CC}			3.5	mA
INA Supply Current (Step-Down)	I _{INA}	ONA = V _{CC} , $\overline{UP}/DN = V_{CC}$ (step-down)			75	μA
INA + V _{CC} Step-Up Supply Current	I _{INA}	ONA = V _{CC} , $\overline{UP}/DN = GND$ (step-up)			475	
5V LINEAR REGULATOR (LDO5)						
LDO5 Output Voltage	V _{LDO5}	V _{INLDO} = 5.5V to 26V, I_{LDO5} = 0 to 50mA, BYP = GND}}	4.75		5.25	V
LDO5 Short-Circuit Current Limit		LDO5 = BYP = GND	55			mA
1.25V REFERENCE						
Reference Output Voltage	V _{REF}	No load	1.237		1.263	V
Reference Load Regulation	ΔV _{REF}	I _{REF} = -1μA to +50μA}			12	mV
OSCILLATOR						
Oscillator Frequency	f _{OSC}	FREQ = GND	0.9		1.1	MHz
Maximum Duty Cycle (All Switching Regulators)	D _{MAX}		89			%
REGULATOR A (Main Step-Up/Step-Down)						
Output-Voltage Adjust Range		Step-up configuration ($\overline{UP}/DN = GND$)	3.0		V _{CC} + 0.3V}	V
		Step-down configuration ($\overline{UP}/DN = V_{CC}$)	1.0		V _{CC} + 0.3V}	
FBA Regulation Voltage		Step-up configuration, V _{CSPA} - V_{CSNA} = 0mV, 90% duty cycle}}	0.970		1.018	V
		Step-down configuration, V _{CSPA} - V_{CSNA} = 0mV, 90% duty cycle}}	0.963		1.008	
FBA Regulation Voltage (Overload)	V _{FBA}	Step-up configuration ($\overline{UP}/DN = GND$), V _{CSPA} - V_{CSNA} = 0 to 20mV, 90% duty cycle}}	0.954		1.018	V
		Step-down configuration ($\overline{UP}/DN = V_{CC}$), V _{CSPA} - V_{CSNA} = 0 to 20mV, 90% duty cycle}}	0.925		1.008	
FBA Line Regulation		Step-up ($\overline{UP}/DN = GND$)	5		19	mV
		Step-down ($\overline{UP}/DN = V_{CC}$)	10		23	
Current-Sense Input Common-Mode Range	V _{CSA}		0		V _{CC} + 0.3V}	V
Current-Limit Threshold (Positive)	V _{LIMA}		17		23	mV

Quad-Output Controller for Low-Power Architecture

MAX17017

ELECTRICAL CHARACTERISTICS (continued)

(Circuit of Figure 1 (step-down), $V_{INLDO} = 12V$, $V_{INA} = V_{INBC} = V_{DD} = V_{CC} = V_{BYP} = V_{CSPA} = V_{CSNA} = 5V$, $V_{IND} = 1.8V$, $V_{SHDN} = V_{ONA} = V_{ONB} = V_{ONC} = V_{OND} = 5V$, $I_{REF} = I_{LDO5} = I_{OUTD} = \text{no load}$, $FREQ = GND$, $UP/DN = V_{CC}$, $T_A = -40^{\circ}\text{C to } +105^{\circ}\text{C}$.) (Note 1)

PARAMETER	SYMBOL	CONDITIONS	$T_A = -40^{\circ}\text{C to } +105^{\circ}\text{C}$			UNITS
			MIN	TYP	MAX	
REGULATOR B (Internal 3A Step-Down Converter)						
FBB Regulation Voltage		$I_{LXB} = 0A$, 0% duty cycle (Note 2)	0.742	0.766		V
FBB Regulation Voltage (Overload)	V_{FBB}	$I_{LXB} = 0$ to 2.5A, 0% duty cycle (Note 2)	0.715	0.766		V
FBB Line Regulation			6	12		mV
LXB Peak Current Limit	I_{PKB}		2.7	4.2		A
REGULATOR C (Internal 5A Step-Down Converter)						
FBC Regulation Voltage		$I_{LXC} = 0A$, 0% duty cycle (Note 2)	0.742	0.766		V
FBC Regulation Voltage (Overload)	V_{FBC}	$I_{LXC} = 0$ to 4A, 0% duty cycle (Note 2)	0.705	0.766		V
FBC Line Regulation			11	20		mV
LXC Peak Current Limit	I_{PKC}		5.0	6.5		A
REGULATOR D (Source/Sink Linear Regulator and VTTR Buffer)						
IND Input Voltage Range	V_{IND}		1	2.8		V
IND Supply Current		$OND = V_{CC}$		70		μA
REFIND Input Range			0.5	1.5		V
OUTD Output Voltage Range	V_{OUTD}		0.5	1.5		V
FBD Output Accuracy	V_{FBD}	V_{FBD} with respect to V_{REFIND} , $OUTD = FBD$, $I_{OUTD} = +50\mu\text{A}$ (source load)	-12	0		mV
		V_{FBD} with respect to V_{REFIND} , $OUTD = FBD$, $I_{OUTD} = -50\mu\text{A}$ (sink load)	0	+12		
FBD Load Regulation		$I_{OUTD} = \pm 1A$	-20			mV/A
OUTD Linear Regulator Current Limit		Source load	+2	+4		A
		Sink load	-2	-4		
Internal MOSFET On-Resistance		High-side on-resistance		300		m Ω
		Low-side on-resistance		475		
VTTR Output Accuracy		REFIND to VTTR $I_{VTTR} = \pm 3\text{mA}$	-20	+20		mV

Quad-Output Controller for Low-Power Architecture

ELECTRICAL CHARACTERISTICS (continued)

(Circuit of Figure 1 (step-down), $V_{INLDO} = 12V$, $V_{INA} = V_{INBC} = V_{DD} = V_{CC} = V_{BYP} = V_{CSPA} = V_{CSNA} = 5V$, $V_{IND} = 1.8V$, $\overline{V_{SHDN}} = V_{ONA} = V_{ONB} = V_{ONC} = V_{OND} = 5V$, $I_{REF} = I_{LDO5} = I_{OUTD} = \text{no load}$, $FREQ = GND$, $\overline{UP/DN} = V_{CC}$, $T_A = -40^{\circ}\text{C to } +105^{\circ}\text{C}$.) (Note 1)

PARAMETER	SYMBOL	CONDITIONS	$T_A = -40^{\circ}\text{C to } +105^{\circ}\text{C}$			UNITS
			MIN	TYP	MAX	
FAULT PROTECTION						
SMPS POK and Fault Thresholds		Upper threshold rising edge, hysteresis = 50mV	8		16	%
		Lower threshold falling edge, hysteresis = 50mV	-16		-8	
VTT LDO POKD and Fault Threshold		Upper threshold rising edge, hysteresis = 50mV	6		16	%
		Lower threshold falling edge, hysteresis = 50mV	-16		-6	
POK Output Low Voltage	V_{POK}	$I_{SINK} = 3mA$			0.4	V
GENERAL LOGIC LEVELS						
\overline{SHDN} Input Logic Threshold		Hysteresis = 20mV	0.5		1.6	V
$ON_$ Input Logic Threshold		Hysteresis = 170mV	0.5		1.6	V
$\overline{UP/DN}$ Input Logic Threshold			0.5		1.6	V
FREQ Input Voltage Levels		High (V_{CC})	$V_{CC} - 0.4V$			V
		Unconnected/REF	1.65		3.8	
		Low (GND)			0.5	
SYNC Input Logic Threshold			1.5		3.5	V

Note 1: Limits are 100% production tested at $T_A = +25^{\circ}\text{C}$. Maximum and minimum limits are guaranteed by design and characterization.

Note 2: Regulation voltage tested with slope compensation. The typical value is equivalent to 0% duty cycle. In real application, the regulation voltage is higher due to the line regulation times the duty cycle.

Quad-Output Controller for Low-Power Architecture

Typical Operating Characteristics

(Circuit of Figure 1, $T_A = +25^\circ\text{C}$, unless otherwise noted.)

MAX17017

SMPS REGULATOR A EFFICIENCY vs. LOAD CURRENT

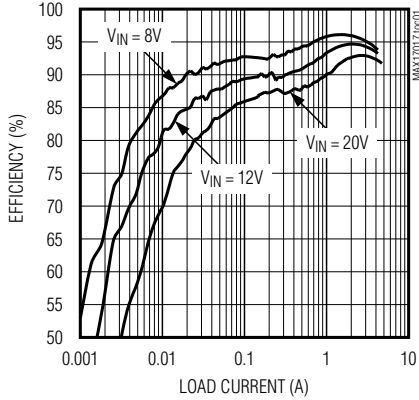

SMPS REGULATOR A OUTPUT VOLTAGE vs. LOAD CURRENT

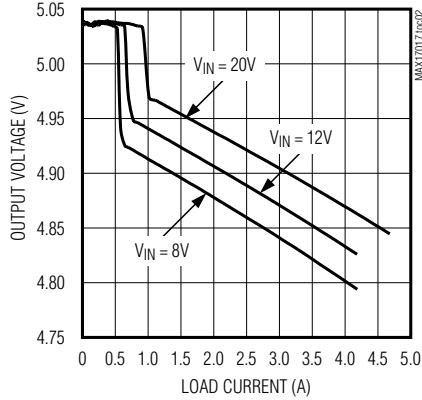

SMPS REGULATOR B EFFICIENCY vs. LOAD CURRENT

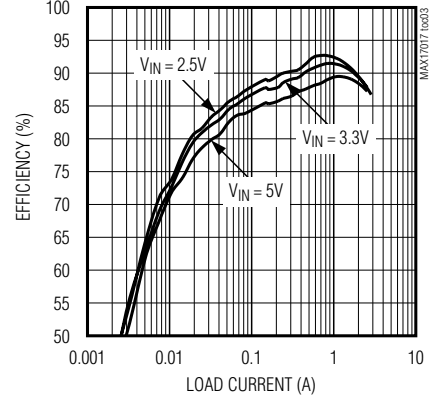

SMPS REGULATOR B OUTPUT VOLTAGE vs. LOAD CURRENT

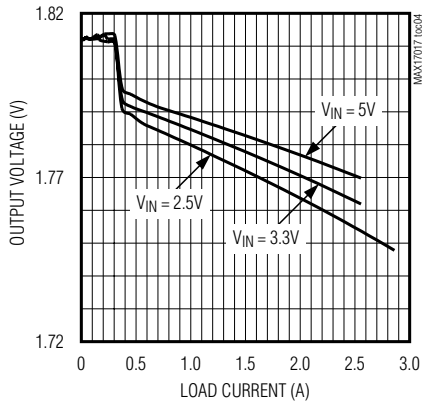

SMPS REGULATOR C EFFICIENCY vs. LOAD CURRENT

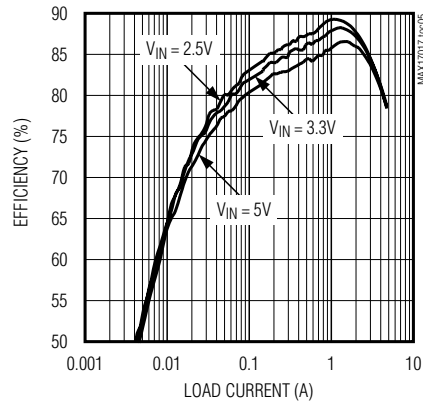

SMPS REGULATOR C OUTPUT VOLTAGE vs. LOAD CURRENT

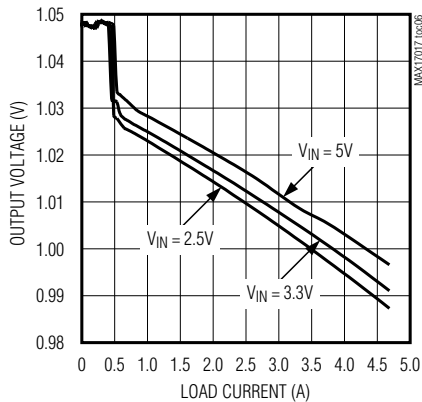

REGULATOR D VOLTAGE vs. SOURCE/SINK LOAD CURRENT

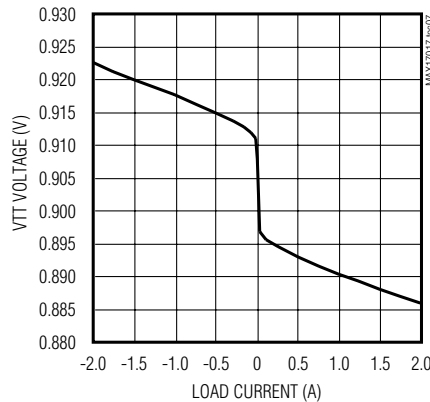

Quad-Output Controller for Low-Power Architecture

Typical Operating Characteristics (continued)

(Circuit of Figure 1, $T_A = +25^\circ\text{C}$, unless otherwise noted.)

REG A STARTUP WAVEFORM (HEAVY LOAD)

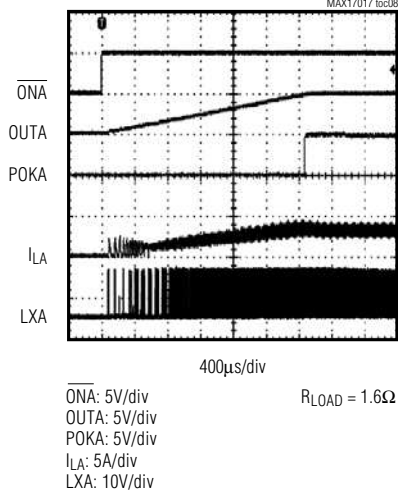

REG A SHUTDOWN WAVEFORM

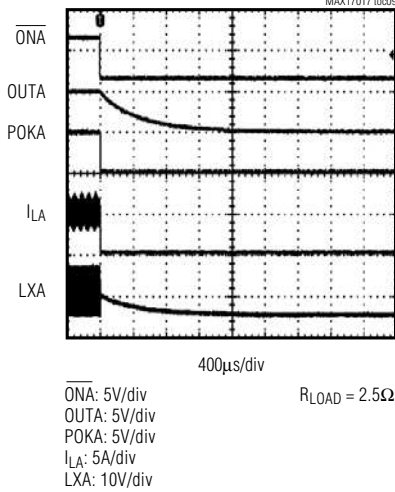

REG B STARTUP WAVEFORM (HEAVY LOAD)

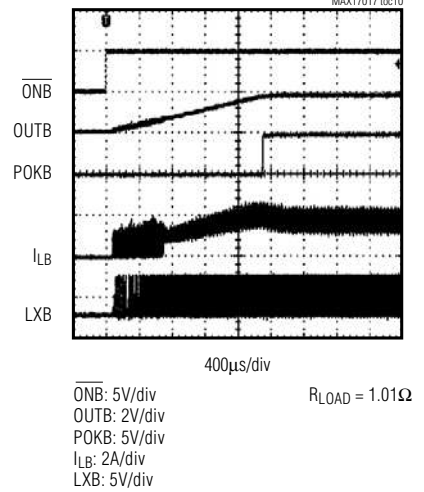

REG B SHUTDOWN WAVEFORM

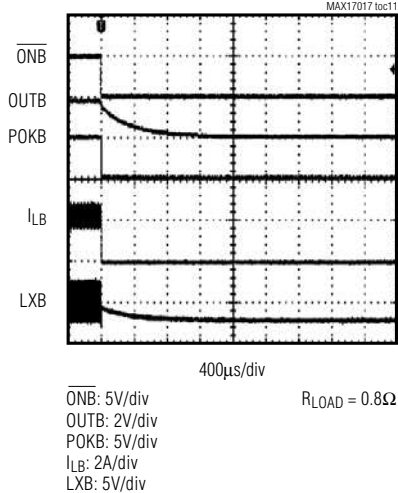

REG C STARTUP WAVEFORM (HEAVY LOAD)

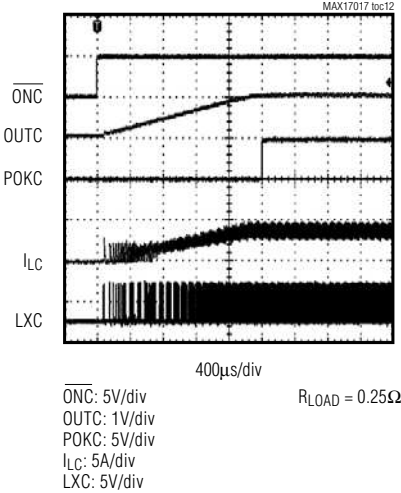

REG C SHUTDOWN

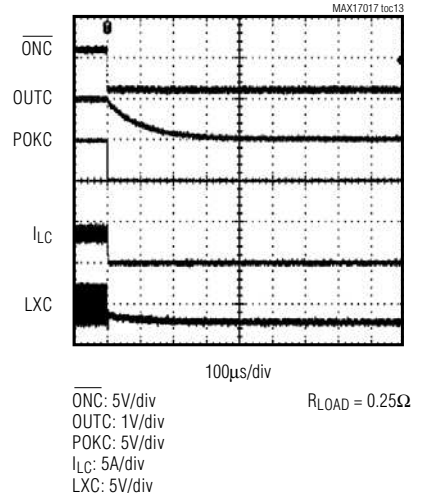

Quad-Output Controller for Low-Power Architecture

MAX17017

Typical Operating Characteristics (continued)

(Circuit of Figure 1, $T_A = +25^\circ\text{C}$, unless otherwise noted.)

REG A LOAD TRANSIENT (1A TO 3.2A)

MAX17017 t0c14

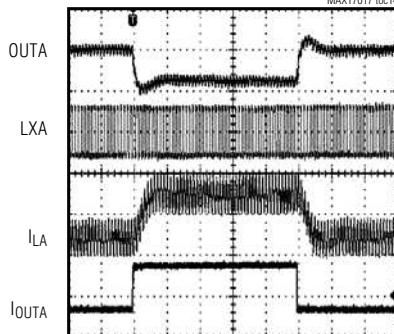

20 $\mu\text{s}/\text{div}$

OUTA: 100mV/div $V_{\text{INA}} = 12\text{V}$, LOAD TRANSIENT
LXA: 10V/div IS FROM 1A TO 3.2A
ILA: 2A/div
IOUTA: 2A/div

REG B LOAD TRANSIENT (0.4A TO 2A)

MAX17017 t0c15

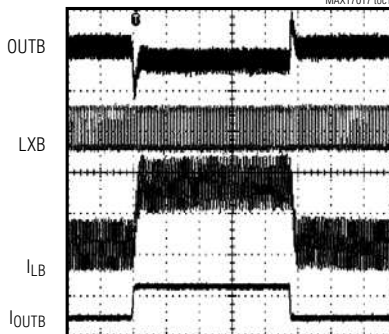

20 $\mu\text{s}/\text{div}$

OUTB: 50mV/div $V_{\text{INB}} = 5\text{V}$, 0.4A TO 2.0A
LXB: 5V/div LOAD TRANSIENT
ILB: 1A/div
IOUTB: 2A/div

REG C LOAD TRANSIENT (0.8A TO 3A)

MAX17017 t0c16

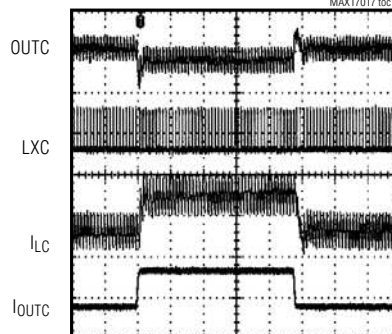

20 $\mu\text{s}/\text{div}$

OUTC: 50mV/div $V_{\text{INB}} = 5\text{V}$, 0.8A TO 3.0A
LXC: 5V/div LOAD TRANSIENT
ILC: 2A/div
IOUTC: 2A/div

REG D LOAD TRANSIENT (SOURCE/SINK)

MAX17017 t0c17

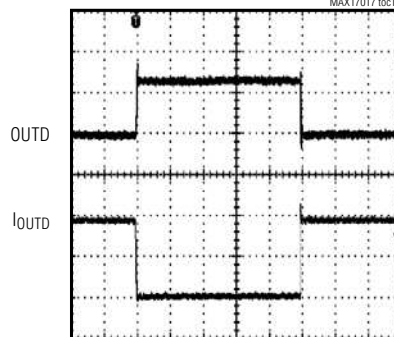

20 $\mu\text{s}/\text{div}$

OUTD: 20mV/div IND = 1.8V, REFIND = 0.9V,
IOUTD: 1A/div $C_{\text{OUT}} = 2 \times 10\mu\text{F}$, LOAD TRANSIENT
IS FROM 1A SOURCING TO 1A SINKING

REG D LOAD TRANSIENT (SINK)

MAX17017 t0c18

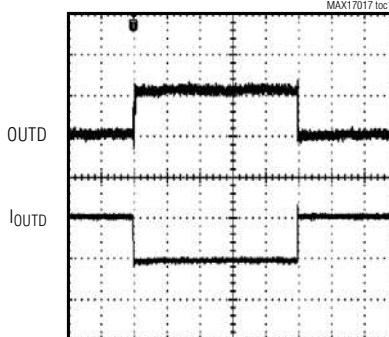

20 $\mu\text{s}/\text{div}$

OUTD: 10mV/div IND = 1.8V, REFIND = 0.9V,
IOUTD: 1A/div $C_{\text{OUT}} = 2 \times 10\mu\text{F}$, LOAD TRANSIENT
IS FROM 0 TO 1A SINKING

REG D LOAD TRANSIENT (SOURCE)

MAX17017 t0c19

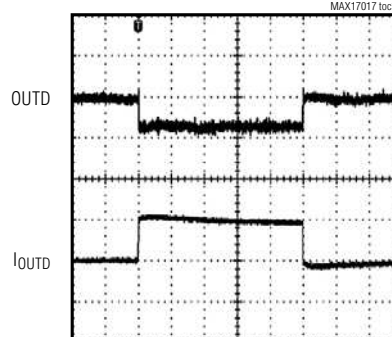

20 $\mu\text{s}/\text{div}$

OUTD: 10mV/div IND = 1.8V, REFIND = 0.9V,
IOUTD: 1A/div $C_{\text{OUT}} = 2 \times 10\mu\text{F}$, LOAD TRANSIENT
IS FROM 0 TO 1A SOURCING

Quad-Output Controller for Low-Power Architecture

Pin Description

PIN	NAME	FUNCTION
1	POKC	Open-Drain Power-Good Output for the Internal 5A Step-Down Converter. POKC is low if FBC is more than 12% (typ) above or below the nominal 0.75V feedback regulation threshold. POKC is held low during startup and in shutdown. POKC becomes high impedance when FBC is in regulation.
2	BSTC	Boost Flying Capacitor Connection for the Internal 5A Step-Down Converter. The MAX17017 includes an internal boost switch/diode connected between V _{DD} and BSTC. Connect to an external capacitor as shown in Figure 1.
3-6	LXC	Inductor Connection for the Internal 5A Step-Down Converter. Connect LXC to the switched side of the inductor.
7, 8	OUTD	Source/Sink Linear Regulator Output. Bypass OUTD with 2x 10μF or greater ceramic capacitors to ground. Dropout needs additional output capacitance (see the <i>VTT LDO Output Capacitor Selection (C_{OUTD})</i> section).
9	IND	Source/Sink Linear Regulator Input. Bypass IND with a 10μF or greater ceramic capacitor to ground.
10	FBD	Feedback Input for the Internal Source/Sink Linear Regulator. FBD tracks and regulates to the REFIND voltage.
11	VTRR	Output of Reference Buffer. Bypass with 0.22μF for ±3mA of output current.
12	REFIND	Dynamic Reference Input Voltage for the Source/Sink Linear Regulator and the Reference Buffer. The linear regulator feedback threshold (FBD) tracks the REFIND voltage.
13	$\overline{\text{SHDN}}$	Shutdown Control Input. The device enters its 5μA supply current shutdown mode if V $\overline{\text{SHDN}}$ is less than the $\overline{\text{SHDN}}$ input falling edge trip level and does not restart until V $\overline{\text{SHDN}}$ is greater than the $\overline{\text{SHDN}}$ input rising edge trip level. Connect $\overline{\text{SHDN}}$ to V _{INLDO} for automatic startup of LDO5.
14	INLDO	Input of the Startup Circuitry and the LDO5 Internal 5V Linear Regulator. Bypass to GND with a 0.1μF or greater ceramic capacitor close to the controller. In the single-cell step-up applications, the 5V linear regulator is no longer necessary for the 5V bias supply. Connect BYP and INLDO to the system's 5V supply to effectively disable the linear regulator.
15	LDO5	5V Internal Linear Regulator Output. Bypass with a 4.7μF or greater ceramic capacitor. The 5V linear regulator provides the bias power for the gate drivers (V _{DD}) and analog control circuitry (V _{CC}). The linear regulator sources up to 50mA (max guaranteed). When BYP exceeds 4.65V (typ), the MAX17017 bypasses the linear regulator through a 1.5_ bypass switch. When the linear regulator is bypassed, LDO5 supports loads up to 100mA. In the single-cell step-up applications, the 5V linear regulator is no longer necessary for the 5V bias supply. Bypass $\overline{\text{SHDN}}$ to ground and leave LDO5 unconnected. Connect BYP and INLDO to effectively disable the linear regulator.
16	BYP	Linear Regulator Bypass Input. When BYP exceeds 4.65V, the controller shorts LDO5 to BYP through a 1.5_ bypass switch and disables the linear regulator. When BYP is low, the linear regulator remains active. The BYP input also serves as the VTRR buffer supply, allowing VTRR to remain active even when the source/sink linear regulator (OUTD) has been disabled under system standby/suspend conditions. In the single-cell step-up applications, the 5V linear regulator is no longer necessary for the 5V bias supply. Bypass LDO5 to ground with a 1μF capacitor and leave this output unconnected. Connect BYP and INLDO to the system's 5V supply to effectively disable the linear regulator.

Quad-Output Controller for Low-Power Architecture

Pin Description (continued)

PIN	NAME	FUNCTION
17	V _{CC}	5V Analog Bias Supply. V _{CC} powers all the analog control blocks (error amplifiers, current-sense amplifiers, fault comparators, etc.) and control logic. Connect V _{CC} to the 5V system supply with a series 10 _Ω resistor, and bypass to analog ground using a 1 μ F or greater ceramic capacitor.
18	INA	Input to the Circuit in Reg A in Boost Mode. Connect INA to the input in step-up mode ($\overline{\text{UP/DN}} = \text{GND}$) and connect INA to LDO5 in step-down mode ($\overline{\text{UP/DN}} = \text{V}_{\text{CC}}$).
19	$\overline{\text{UP/DN}}$	Converter Configuration Selection Input for Regulator A. When $\overline{\text{UP/DN}}$ is pulled high ($\overline{\text{UP/DN}} = \text{V}_{\text{CC}}$), regulator A operates as a step-down converter (Figure 1). When $\overline{\text{UP/DN}}$ is pulled low ($\overline{\text{UP/DN}} = \text{GND}$), regulator A operates as a step-up converter.
20	FREQ	Trilevel Oscillator Frequency Selection Input. FREQ = V _{CC} : RegA = 250kHz, RegB = 500kHz, RegC = 250kHz FREQ = REF: RegA = 375kHz, RegB = 750kHz, RegC = 375kHz FREQ = GND: RegA = 500kHz, RegB = 1MHz, RegC = 500kHz
21	REF	1.25V Reference-Voltage Output. Bypass REF to analog ground with a 0.1 μ F ceramic capacitor. The reference sources up to 50 μ A for external loads. Loading REF degrades output voltage accuracy according to the REF load-regulation error. The reference shuts down when the system pulls $\overline{\text{SHDN}}$ low in buck mode ($\overline{\text{UP/DN}} = \text{GND}$) or when the system pulls ONA low in boost mode ($\overline{\text{UP/DN}} = \text{V}_{\text{CC}}$).
22	AGND	Analog Ground
23	CSNA	Negative Current-Sense Input for the Main Switching Regulator. Connect to the negative terminal of the current-sense resistor. Due to the CSNA bias current requirements, limit the series impedance to less than 10 Ω .
24	CSPA	Positive Current-Sense Input for the Main Switching Regulator. Connect to the positive terminal of the current-sense resistor. Due to the CSPA bias current requirements, limit the series impedance to less than 10 Ω .
25	FBA	Feedback Input for the Main Switching Regulator. FBA regulates to 1.0V.
26	POKA	Open-Drain Power-Good Output for the Main Switching Regulator. POKA is low if FBA is more than 12% (typ) above or below the nominal 1.0V feedback regulation point. POKA is held low during soft-start and in shutdown. POKA becomes high impedance when FBA is in regulation.
27	DHA	High-Side Gate-Driver Output for the Main Switching Regulator. DHA swings from LXA to BSTA.
28	LXA	Inductor Connection of Converter A. Connect LXA to the switched side of the inductor.
29	BSTA	Boost Flying Capacitor Connection of Converter A. The MAX17017 includes an internal boost switch/diode connected between V _{DD} and BSTA. Connect to an external capacitor as shown in Figure 1.
30	DLA	Low-Side Gate-Driver Output for the Main Switching Regulator. DLA swings from GND to V _{DD} .
31, 32, 33	LXB	Inductor Connection for the Internal 3A Step-Down Converter. Connect LXB to the switched side of the inductor.
34	BSTB	Boost Flying Capacitor Connection for the Internal 3A Step-Down Converter. The MAX17017 includes an internal boost switch/diode connected between V _{DD} and BSTB. Connect to an external capacitor as shown in Figure 1.
35	POKB	Open-Drain Power-Good Output for the Internal 3A Step-Down Converter. POKB is low if FBB is more than 12% (typ) above or below the nominal 0.75V feedback-regulation threshold. POKB is held low during soft-start and in shutdown. POKB becomes high impedance when FBB is in regulation.

MAX17017

Quad-Output Controller for Low-Power Architecture

Pin Description (continued)

PIN	NAME	FUNCTION
36	FBB	Feedback Input for the Internal 3A Step-Down Converter. FBB regulates to 0.75V.
37	ONB	Switching Regulator B Enable Input. When ONB is pulled low, LXB is high impedance. When ONB is driven high, the controller enables the 3A internal switching regulator.
38	SYNC	External Synchronization Input. Used to override the internal switching frequency.
39	ONA	Switching Regulator A Enable Input. When ONA is pulled low, DLA and DHA are pulled low. When ONA is driven high, the controller enables the step-up/step-down converter.
40–43	INBC	Input for Regulators B and C. Power INBC from a 2.5V to 5.5V supply. Internally connected to the drain of the high-side MOSFETs for both regulator B and regulator C. Bypass to PGND with 2x 10 μ F or greater ceramic capacitors to support the RMS current.
44	VDD	5V Bias Supply Input for the Internal Switching Regulator Drivers. Bypass with a 1 μ F or greater ceramic capacitor. Provides power for the BSTB and BSTC driver supplies.
45	POKD	Open-Drain Power-Good Output for the Internal Source/Sink Linear Regulator. POKD is low if FBD is more than 10% (typ) above or below the REFIN regulation threshold. POKD is held low during soft-start and in shutdown. POKD becomes high impedance when FBD is in regulation.
46	OND	Source/Sink Linear Regulator (Regulator D) and Reference Buffer Enable Input. When OND is pulled low, OUTD is high impedance. When OND is driven high, the controller enables the source/sink linear regulator.
47	ONC	Switching Regulator C Enable Input. When ONC is pulled low, LXC is high impedance. When ONC is driven high, the controller enables the 5A internal switching regulator.
48	FBC	Feedback Input for the Internal 5A Step-Down Converter. FBC regulates to 0.75V.
EP	PGND	Power Ground. The source of the low-side MOSFETs (REG B and REG C), the drivers for all switching regulators, and the sink MOSFET of the VTT LDO are all internally connected to the exposed pad. Connect the exposed backside pad to system power ground planes through multiple vias.

Detailed Description

The MAX17017 standard application circuit (Figure 1) provides a 5V/5A_{P-P} main stage, a 1.8V/3A_{P-P} VDDQ and 0.9A/2A VTT outputs for DDR, and a 1.05V/5A_{P-P} chipset supply.

The MAX17017 supports four power outputs—one high-voltage step-down controller, two internal MOSFET step-down switching regulators, and one high-current source/sink linear regulator. The step-down switching regulators use a current-mode fixed-frequency architecture compensated by the output capacitance. An internal 50mA 5V linear regulator provides the bias supply and driver supplies, allowing the controller to power up from input supplies greater than 5.5V.

Fixed 5V Linear Regulator (LDO5)

An internal linear regulator produces a preset 5V low-current output from INLDO. LDO5 powers the gate drivers for the external MOSFETs, and provides the bias

supply required for the SMPS analog controller, reference, and logic blocks. LDO5 supplies at least 50mA for external and internal loads, including the MOSFET gate drive, which typically varies from 5mA to 15mA per switching regulator, depending on the switching frequency. Bypass LDO5 with a 4.7 μ F or greater ceramic capacitor to guarantee stability under the full-load conditions.

The MAX17017 switch-mode step-down switching regulators require a 5V bias supply in addition to the main-power input supply. This 5V bias supply is generated by the controller's internal 5V linear regulator (LDO5). This boot-strappable LDO allows the controller to power up independently. The gate-driver VDD input supply is typically connected to the fixed 5V linear regulator output (LDO5). Therefore, the 5V LDO supply must provide LDO5 (PWM controller) and the gate-drive power during power-up.

Quad-Output Controller for Low-Power Architecture

MAX17017

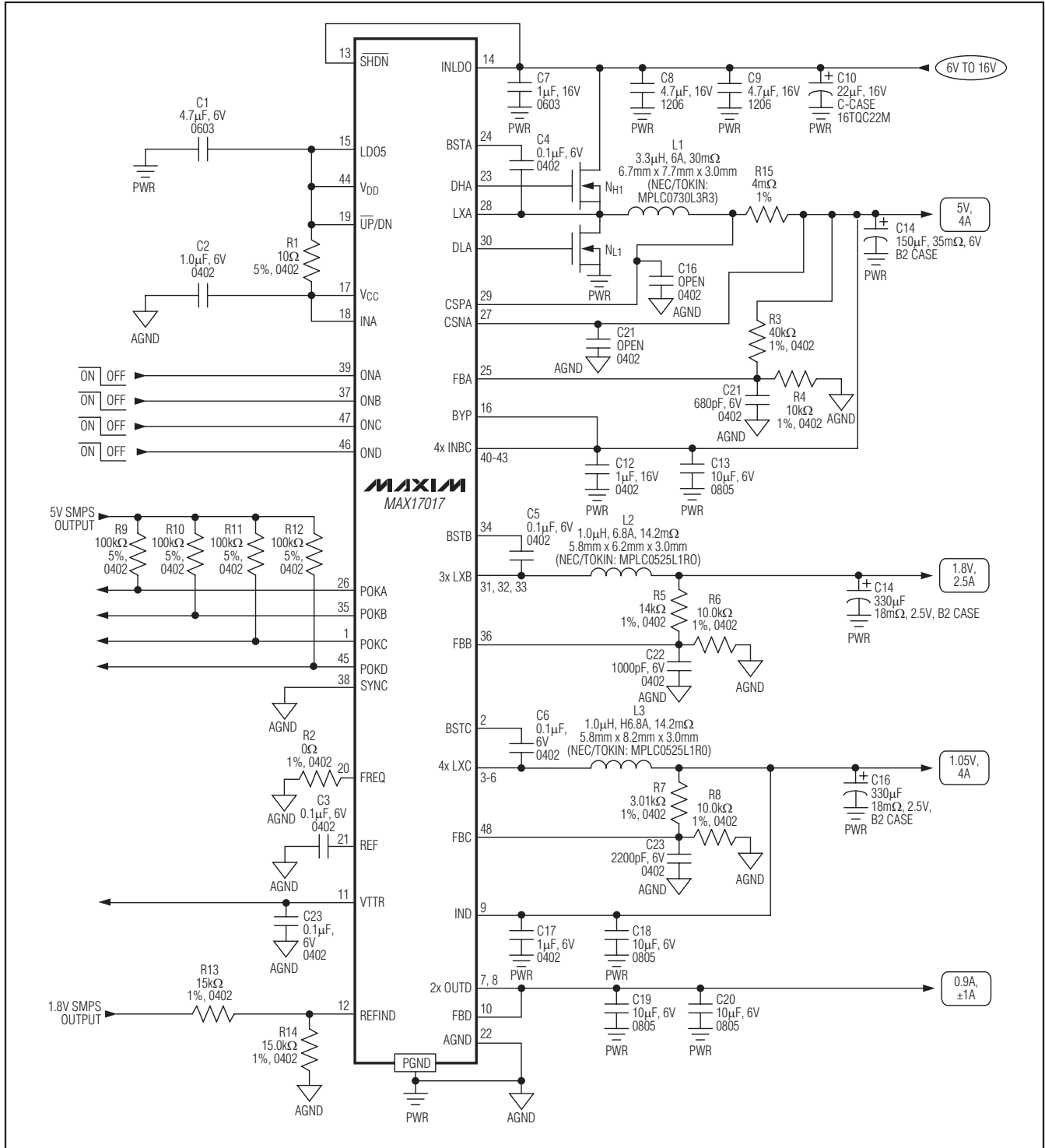

Figure 1. Standard Application Circuit

Quad-Output Controller for Low-Power Architecture

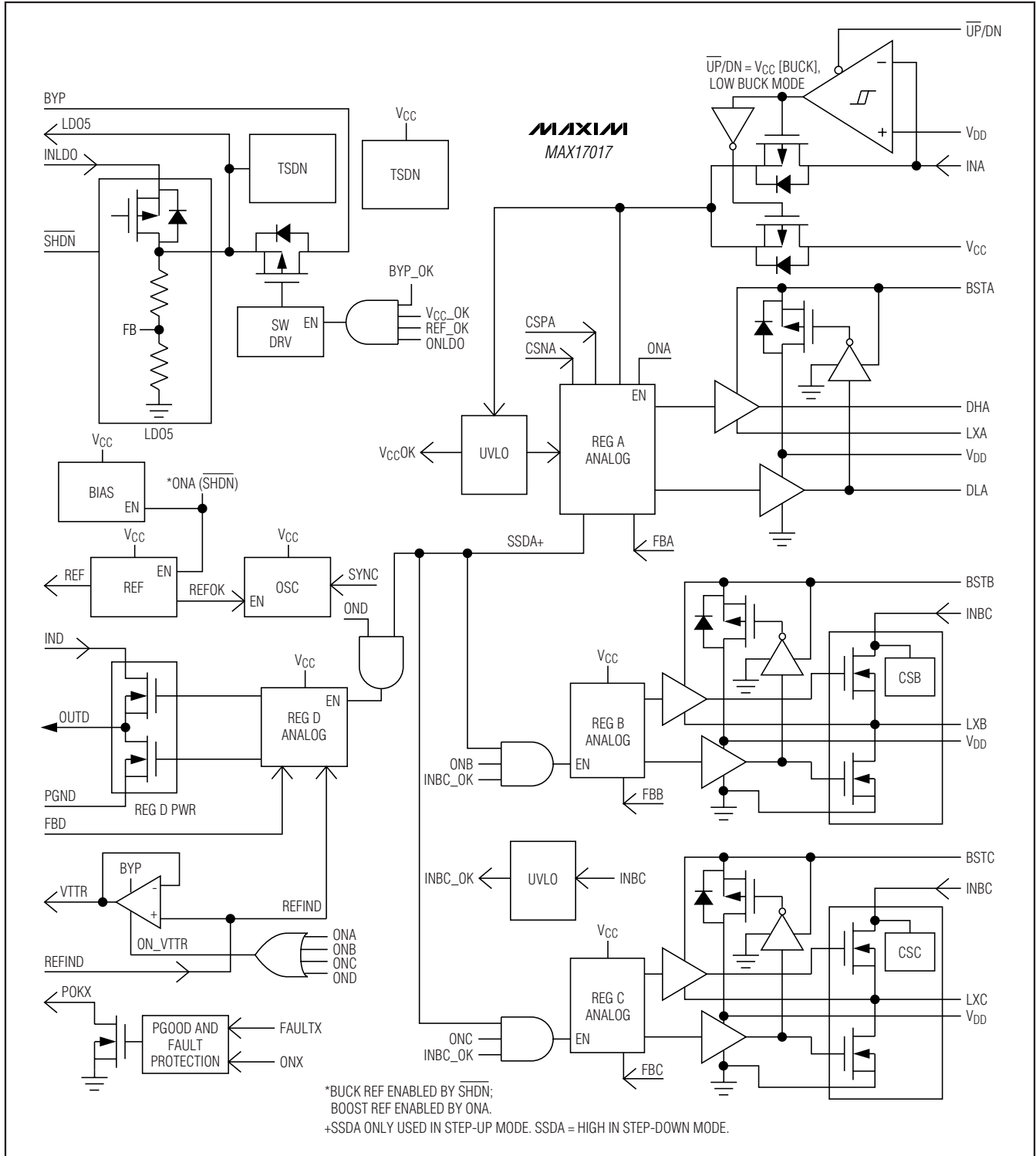

Figure 2. MAX17017 Block Diagram

Quad-Output Controller for Low-Power Architecture

LDO5 Bootstrap Switchover

When the bypass input (BYP) exceeds the LDO5 bootstrap switchover threshold for more than 500 μ s, an internal 1.5 Ω (typ) p-channel MOSFET shorts BYP to LDO5, while simultaneously disabling the LDO5 linear regulator. This bootstraps the controller, allowing power for the internal circuitry and external LDO5 loading to be generated by the output of a 5V switching regulator. Bootstrapping reduces power dissipation due to driver and quiescent losses by providing power from a switch-mode source, rather than from a much-less-efficient linear regulator. The current capability increases from 50mA to 100mA when the LDO5 output is switched over to BYP. When BYP drops below the bootstrap threshold, the controller immediately disables the bootstrap switch and reenables the 5V LDO.

Reference (REF)

The 1.25V reference is accurate to $\pm 1\%$ over temperature and load, making REF useful as a precision system reference. Bypass REF to GND with a 0.1 μ F or greater ceramic capacitor. The reference sources up to 50 μ A and sinks 5 μ A to support external loads. If highly accurate specifications are required for the main SMPS output voltages, the reference should not be loaded. Loading the reference slightly reduces the output voltage accuracy because of the reference load-regulation error.

SMPS Detailed Description

Fixed-Frequency, Current-Mode PWM Controller

The heart of each current-mode PWM controller is a multi-input, open-loop comparator that sums multiple signals: the output-voltage error signal with respect to the reference voltage, the current-sense signal, and the slope compensation ramp (Figure 3). The MAX17017 uses a direct-summing configuration, approaching ideal cycle-to-cycle control over the output voltage without a traditional error amplifier and the phase shift associated with it.

Frequency Selection (FREQ)

The FREQ input selects the PWM mode switching frequency. Table 1 shows the switching frequency based on the FREQ connection. High-frequency (FREQ = GND) operation optimizes the application for the smallest component size, trading off efficiency due to higher switching losses. This might be acceptable in ultra-portable devices where the load currents are lower. Low-frequency (FREQ = 5V) operation offers the best overall efficiency at the expense of component size and board space.

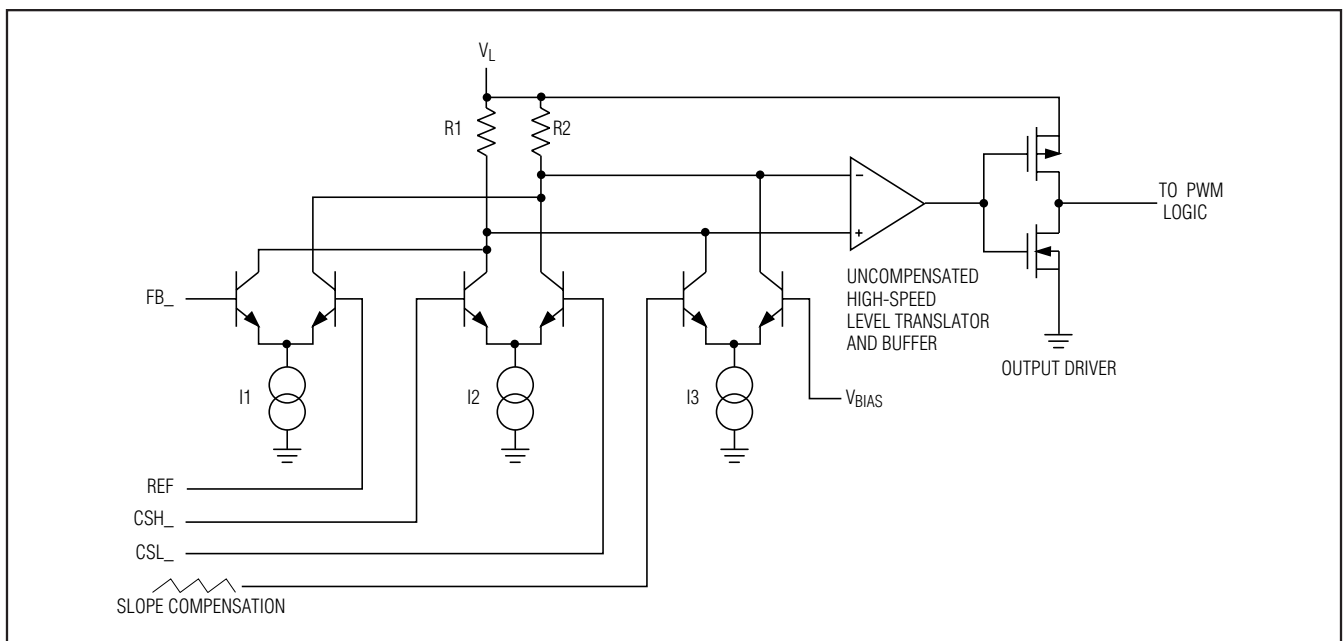

Figure 3. PWM Comparator Functional Diagram

Quad-Output Controller for Low-Power Architecture

Table 1. FREQ Table

PIN SELECT	REG A AND REG C			REG B		
	SWITCHING FREQUENCY	SOFT-START TIME	STARTUP BLANKING TIME	SWITCHING FREQUENCY	SOFT-START TIME	STARTUP BLANKING TIME
	f_{SWA} AND f_{SWC}	REG A: $1200/f_{\text{SWA}}$ REG C: $900/f_{\text{SWC}}$	$1500/f_{\text{SWA}}$	f_{SWB}	$1800/f_{\text{SWB}}$	$3000/f_{\text{SWB}}$
LDO5	250kHz	REG A: 4.8ms REG C: 3.6ms	6ms	500kHz	3.6ms	6ms
REF	375kHz	REG A: 3.2ms REG C: 2.4ms	4ms	750kHz	2.4ms	4ms
GND	500kHz	REG A: 2.4ms REG C: 1.8ms	3ms	1MHz	1.8ms	3ms
SYNC	$0.5 \times f_{\text{SYNC}}$	—	—	f_{SYNC}	—	—

Light-Load Operation Control

The MAX17017 uses a light-load pulse-skipping operating mode for all switching regulators. The switching regulators turn off the low-side MOSFETs when the current sense detects zero inductor current. This keeps the inductor from discharging the output capacitors and forces the switching regulator to skip pulses under light-load conditions to avoid overcharging the output.

Idle-Mode Current-Sense Threshold

When pulse-skipping mode is enabled, the on-time of the step-down controller terminates when the output voltage exceeds the feedback threshold and when the current-sense voltage exceeds the idle-mode current-sense threshold. Under light-load conditions, the on-time duration depends solely on the idle-mode current-sense threshold. This forces the controller to source a minimum amount of power with each cycle. To avoid overcharging the output, another on-time cannot begin until the output voltage drops below the feedback threshold. Since the zero-crossing comparator prevents the switching regulator from sinking current, the MAX17017 switching regulators must skip pulses. Therefore, the controller regulates the valley of the output ripple under light-load conditions.

Automatic Pulse-Skipping Crossover

In skip mode, an inherent automatic switchover to PFM takes place at light loads. This switchover is affected by a comparator that truncates the low-side switch on-time at the inductor current's zero crossing. The zero-crossing

comparator senses the inductor current during the off-time. For regulator A, once $V_{\text{CSPA}} - V_{\text{CSNA}}$ drops below the 1mV zero-crossing current-sense threshold, the comparator turns off the low-side MOSFET (DLA pulled low). For regulators B and C, once the current through the low-side MOSFET drops below 100mA, the zero-crossing comparator turns off the low-side MOSFET.

The minimum idle-mode current requirement causes the threshold between pulse-skipping PFM operation and constant PWM operation to coincide with the boundary between continuous and discontinuous inductor-current operation (also known as the critical conduction point). The load-current level at which PFM/PWM crossover occurs ($I_{\text{LOAD(SKIP)}}$) is equivalent to half the idle-mode current threshold (see the *Electrical Characteristics* table for the idle-mode thresholds of each regulator). The switching waveforms can appear noisy and asynchronous when light loading causes pulse-skipping operation, but this is a normal operating condition that results in high light-load efficiency. Trade-offs in PFM noise vs. light-load efficiency are made by varying the inductor value. Generally, low inductor values produce a broader efficiency vs. load curve, while higher values result in higher full-load efficiency (assuming that the coil resistance remains fixed) and less output voltage ripple. Penalties for using higher inductor values include larger physical size and degraded load-transient response (especially at low input-voltage levels).

Quad-Output Controller for Low-Power Architecture

SMPS POR, UVLO, and Soft-Start

Power-on reset (POR) occurs when V_{CC} rises above approximately 1.9V, resetting the undervoltage, overvoltage, and thermal-shutdown fault latches. The POR circuit also ensures that the low-side drivers are pulled low until the SMPS controllers are activated. The V_{CC} input undervoltage lockout (UVLO) circuitry prevents the switching regulators from operating if the 5V bias supply (V_{CC} and V_{DD}) is below its 4.2V UVLO threshold.

Regulator A Startup

Once the 5V bias supply rises above this input UVLO threshold and ONA is pulled high, the main step-down controller (regulator A) is enabled and begins switching. The internal voltage soft-start gradually increments the feedback voltage by 10mV every 12 switching cycles. Therefore, OUTA reaches its nominal regulation voltage $1200/f_{swA}$ after regulator A is enabled (see the REG A Startup Waveform (Heavy Load) graph in the *Typical Operating Characteristics*).

Regulator B and C Startup

The internal step-down controllers start switching and the output voltages ramp up using soft-start. If the bias supply voltage drops below the UVLO threshold, the controller stops switching and disables the drivers (LX_ becomes high impedance) until the bias supply voltage recovers.

Once the 5V bias supply and INBC rise above their respective input UVLO thresholds (\overline{SHDN} must be pulled high to enable the reference), and ONB or ONC is pulled high, the respective internal step-down controller (regulator B or C) becomes enabled and begins switching. The internal voltage soft-start gradually increments the feedback voltage by 10mV every 24 switching cycles for regulator B or every 12 switching cycles for regulator C. Therefore, OUTB reaches its nominal regulation voltage $1800/f_{swB}$ after regulator B is enabled, and OUTC reaches its nominal regulation voltage $900/f_{swC}$ after regulator C is enabled (see the REG B Startup Waveform (Heavy Load) and REG C Startup Waveform (Heavy Load) graphs in the *Typical Operating Characteristics*).

SMPS Power-Good Outputs (POK)

POKA, POKB, and POKC are the open-drain outputs of window comparators that continuously monitor each output for undervoltage and overvoltage conditions. POK_ is actively held low in shutdown ($\overline{SHDN} = GND$), standby (ONA = ONB = ONC = GND), and soft-start. Once the soft-start sequence terminates, POK_

becomes high impedance as long as the output remains within $\pm 8\%$ (min) of the nominal regulation voltage set by FB_. POK_ goes low once its corresponding output drops 12% (typ) below its nominal regulation point, an output overvoltage fault occurs, or the output is shut down. For a logic-level POK_ output voltage, connect an external pullup resistor between POK_ and LDO5. A 100k Ω pullup resistor works well in most applications.

SMPS Fault Protection

Output Overvoltage Protection (OVP)

If the output voltage rises above 112% (typ) of its nominal regulation voltage, the controller sets the fault latch, pulls POK_ low, shuts down the respective regulator, and immediately pulls the output to ground through its low-side MOSFET. Turning on the low-side MOSFET with 100% duty cycle rapidly discharges the output capacitors and clamps the output to ground. However, this commonly undamped response causes negative output voltages due to the energy stored in the output LC at the instant the OVP occurs. If the load cannot tolerate a negative voltage, place a power Schottky diode across the output to act as a reverse-polarity clamp. If the condition that caused the overvoltage persists (such as a shorted high-side MOSFET), the input source also fails (short-circuit fault). Cycle V_{CC} below 1V or toggle the respective enable input to clear the fault latch and restart the regulator.

Output Undervoltage Protection (UVP)

Each MAX17017 includes an output undervoltage (UVP)-protection circuit that begins to monitor the output once the startup blanking period has ended. If any output voltage drops below 88% (typ) of its nominal regulation voltage, the UVP protection immediately sets the fault latch, pulls the respective POK output low, forces the high-side and low-side MOSFETs into high-impedance states (DH = DL = low), and shuts down the respective regulator. Cycle V_{CC} below 1V or toggle the respective enable input to clear the fault latch and restart the regulator.

Thermal-Fault Protection

The MAX17017 features a thermal-fault-protection circuit. When the junction temperature rises above $+160^{\circ}\text{C}$, a thermal sensor activates the fault latch, pulls **all** POK outputs low, and shuts down **all** regulators. Toggle \overline{SHDN} to clear the fault latch and restart the controllers after the junction temperature cools by 15°C .

Quad-Output Controller for Low-Power Architecture

VTT LDO Detailed Description

VTT LDO Power-Good Output (POKD)

POKD is the open-drain output of a window comparator that continuously monitors the VTT LDO output for undervoltage and overvoltage conditions. POKD is actively held low when the VTT LDO is disabled (OND = GND) and soft-start. Once the startup blanking time expires, POKD becomes high impedance as long as the output remains within $\pm 6\%$ (min) of the nominal regulation voltage set by REFIND. POKD goes low once its corresponding output drops or rises 12% (typ) beyond its nominal regulation point or the output is shut down. For a logic-level POKD output voltage, connect an external pullup resistor between POKD and LDO5. A 100k Ω pullup resistor works well in most applications.

VTT LDO Fault Protection

LDO Output Overvoltage Protection (OVP)

If the output voltage rises above 112% (typ) of its nominal regulation voltage, the controller sets the fault latch, pulls POKD low, shuts down the source/sink linear regulator, and immediately pulls the output to ground through its low-side MOSFET. Turning on the low-side MOSFET with 100% duty cycle rapidly discharges the output capacitors and clamps the output to ground. Cycle VCC below 1V or toggle OND to clear the fault latch and restart the linear regulator.

LDO Output Undervoltage Protection (UVP)

Each MAX17017 includes an output undervoltage protection (UVP) circuit that begins to monitor the output once the startup blanking period has ended. If the source/sink LDO output voltage drops below 88% (typ) of its nominal REFIND regulation voltage for 5ms, the UVP protection sets the fault latch, pulls the POKD output low, forces the output into a high-impedance state, and shuts down the linear regulator. Cycle VCC below 1V or toggle OND to clear the fault latch and restart the regulator.

SMPS Design Procedure (Step Down Regulators)

Firmly establish the input voltage range and maximum load current before choosing a switching frequency and inductor operating point (ripple-current ratio). The primary design trade-off lies in choosing a good switching frequency and inductor operating point, and the following four factors dictate the rest of the design:

- **Input voltage range.** The maximum value ($V_{IN(MAX)}$) must accommodate the worst-case, high AC-adaptor voltage. The minimum value ($V_{IN(MIN)}$) must account for the lowest battery voltage after drops

due to connectors, fuses, and battery selector switches. If there is a choice at all, lower input voltages result in better efficiency.

- **Maximum load current.** There are two values to consider. The peak load current ($I_{LOAD(MAX)}$) determines the instantaneous component stresses and filtering requirements and thus drives output capacitor selection, inductor saturation rating, and the design of the current-limit circuit. The continuous load current (I_{LOAD}) determines the thermal stresses and thus drives the selection of input capacitors, MOSFETs, and other critical heat-contributing components.
- **Switching frequency.** This choice determines the basic trade-off between size and efficiency. The optimal frequency is largely a function of maximum input voltage, due to MOSFET switching losses that are proportional to frequency and V_{IN}^2 .
- **Inductor operating point.** This choice provides trade-offs between size vs. efficiency and transient response vs. output ripple. Low inductor values provide better transient response and smaller physical size, but also result in lower efficiency, higher output ripple, and lower maximum load current, and due to increased ripple currents. The minimum practical inductor value is one that causes the circuit to operate at the edge of critical conduction (where the inductor current just touches zero with every cycle at maximum load). Inductor values lower than this grant no further size-reduction benefit. The optimum operating point is usually found between 20% and 50% ripple current. When pulse skipping (light loads), the inductor value also determines the load-current value at which PFM/PWM switchover occurs.

Step-Down Inductor Selection

The switching frequency and inductor operating point determine the inductor value as follows:

$$L = \frac{V_{OUT}(V_{IN} - V_{OUT})}{V_{IN}f_{SW}I_{LOAD(MAX)}LIR}$$

Find a low-loss inductor having the lowest possible DC resistance that fits in the allotted dimensions. Most inductor manufacturers provide inductors in standard values, such as 1.0 μ H, 1.5 μ H, 2.2 μ H, 3.3 μ H, etc. Also look for nonstandard values, which can provide a better compromise in LIR across the input voltage range. If using a swinging inductor (where the no-load inductance decreases linearly with increasing current), evaluate the LIR with properly scaled inductance values. For

Quad-Output Controller for Low-Power Architecture

the selected inductance value, the actual peak-to-peak inductor ripple current ($\Delta I_{\text{INDUCTOR}}$) is defined by:

$$\Delta I_{\text{INDUCTOR}} = \frac{V_{\text{OUT}}(V_{\text{IN}} - V_{\text{OUT}})}{V_{\text{IN}}f_{\text{SW}}L}$$

Ferrite cores are often the best choice, although soft saturating molded core inductors are inexpensive and can work well at 500kHz. The core must be large enough not to saturate at the peak inductor current (I_{PEAK}):

$$I_{\text{PEAK}} = I_{\text{LOAD(MAX)}} + \left(\frac{\Delta I_{\text{INDUCTOR}}}{2} \right)$$

SMPS Output Capacitor Selection

The output filter capacitor selection requires careful evaluation of several different design requirements—stability, transient response, and output ripple voltage—that place limits on the output capacitance and ESR. Based on these requirements, the typical application requires a low-ESR polymer capacitor (lower cost but higher output-ripple voltage) or bulk ceramic capacitors (higher cost but low output-ripple voltage).

SMPS Loop Compensation

Voltage positioning dynamically lowers the output voltage in response to the load current, reducing the loop gain. This reduces the output capacitance requirement (stability and transient) and output power dissipation requirements as well. The load-line is generated by sensing the inductor current through the high-side MOSFET on-resistance, and is internally preset to -5mV/A (typ) for regulator B and -7mV/A (typ) for regulator C. The load-line ensures that the output voltage remains within the regulation window over the full-load conditions.

The load line of the internal SMPS regulators also provides the AC ripple voltage required for stability. To maintain stability, the output capacitive ripple must be kept smaller than the internal AC ripple voltage, and crossover must occur before the Nyquist pole— $(2f_{\text{SW}})/(1+D)$ occurs. Based on these loop requirements, a minimum output capacitance can be determined from the following:

When using only ceramic capacitors on the output, the required output capacitance is:

$$C_{\text{OUT}} > \left(\frac{1}{2f_{\text{SW}}R_{\text{DROOP}}} \right) \left(\frac{V_{\text{FB}}}{V_{\text{OUT}}} \right) \left(1 + \frac{V_{\text{OUT}}}{V_{\text{IN}}} \right)$$

where R_{DROOP} is $2R_{\text{SENSE}}$ for regulator A, 5mV/A for regulator B, or 7mV/A for regulator C as defined in the

Electrical Characteristics table, and f_{SW} is the switching frequency selected by the FREQ setting (see Table 1).

When using only polymer capacitors on the output, the additional ESR of the output (R_{ESR}) must be taken into consideration.

For duty cycles less than 40% using polymer capacitors:

$$C_{\text{OUT}} > \left(\frac{1}{2f_{\text{SW}}(R_{\text{DROOP}} + R_{\text{ESR}} \times V_{\text{FB}} / V_{\text{OUT}})} \right) \left(\frac{V_{\text{FB}}}{V_{\text{OUT}}} \right) \left(1 + \frac{V_{\text{OUT}}}{V_{\text{IN}}} \right)$$

For duty cycles above 40% using polymer capacitors, the ESR and C_{OUT} must meet the conditions listed below:

$$R_{\text{ESR}} < R_{\text{DROOP}} \left(\frac{V_{\text{OUT}}}{V_{\text{FB}}} \right)$$

$$C_{\text{OUT}} > \left(\frac{1}{2f_{\text{SW}}R_{\text{DROOP}}} \right) \left(\frac{V_{\text{FB}}}{V_{\text{OUT}}} \right) \left(1 + \frac{V_{\text{OUT}}}{V_{\text{IN}}} \right)$$

When the ESR condition described above is not satisfied, or when using a mix of ceramic and polymer capacitors on the output, an additional feedback pole-capacitor from FB to analog ground (C_{FB}) is necessary to cancel the output capacitor ESR zero:

$$C_{\text{FB}} > \left(\frac{C_{\text{OUT}}R_{\text{ESR}}}{R_{\text{FB}}} \right)$$

where R_{FB} is the parallel impedance of the FB resistive divider.

SMPS Output Ripple Voltage

With polymer capacitors, the effective series resistance (ESR) dominates and determines the output ripple voltage. The step-down regulator's output ripple voltage (V_{RIPPLE}) equals the total inductor ripple current ($\Delta I_{\text{INDUCTOR}}$) multiplied by the output capacitor's ESR. Therefore, the maximum ESR to meet the output ripple voltage requirement is:

$$R_{\text{ESR}} \leq \left[\frac{V_{\text{IN}}f_{\text{SW}}L}{(V_{\text{IN}} - V_{\text{OUT}})V_{\text{OUT}}} \right] V_{\text{RIPPLE}}$$

where f_{SW} is the switching frequency. The actual capacitance value required relates to the physical case size needed to achieve the ESR requirement, as well as to the capacitor chemistry. Thus, polymer capacitor selection is usually limited by ESR and voltage rating rather than by capacitance value. Alternatively, combining ceramics (for the low ESR) and polymers (for the bulk capacitance) helps balance the output capacitance vs. output ripple voltage requirements.

Quad-Output Controller for Low-Power Architecture

Internal SMPS Transient Response

The load-transient response depends on the overall output impedance over frequency, and the overall amplitude and slew rate of the load step. In applications with large, fast load transients (load step > 80% of full load and slew rate > 10A/μs), the output capacitor's high-frequency response—ESL and ESR—needs to be considered. To prevent the output voltage from spiking too low under a load-transient event, the ESR is limited by the following equation (ignoring the sag due to finite capacitance):

$$R_{ESR} \leq \left(\frac{V_{STEP}}{\Delta I_{LOAD(MAX)}} - R_{PCB} \right)$$

where V_{STEP} is the allowed voltage drop, $\Delta I_{LOAD(MAX)}$ is the maximum load step, and R_{PCB} is the parasitic board resistance between the load and output capacitor.

The capacitance value dominates the midfrequency output impedance and dominates the load-transient response as long as the load transient's slew rate is less than two switching cycles. Under these conditions, the sag and soar voltages depend on the output capacitance, inductance value, and delays in the transient response. Low inductor values allow the inductor current to slew faster, replenishing charge removed from or added to the output filter capacitors by a sudden load step, especially with low differential voltages across the inductor. The sag voltage (V_{SAG}) that occurs after applying the load current can be estimated by the following:

$$V_{SAG} = \frac{L(\Delta I_{LOAD(MAX)})^2}{2C_{OUT}(V_{IN} \times D_{MAX} - V_{OUT})} + \frac{\Delta I_{LOAD(MAX)}(T - \Delta T)}{C_{OUT}}$$

where D_{MAX} is the maximum duty factor (see the *Electrical Characteristics* table), T is the switching period ($1/f_{OSC}$), and ΔT equals $V_{OUT}/V_{IN} \times T$ when in PWM mode, or $L \times I_{IDLE}/(V_{IN} - V_{OUT})$ when in pulse-skipping mode. The amount of overshoot voltage (V_{SOAR}) that occurs after load removal (due to stored inductor energy) can be calculated as:

$$V_{SOAR} \approx \frac{(\Delta I_{LOAD(MAX)})^2 L}{2C_{OUT}V_{OUT}}$$

When using low-capacity ceramic filter capacitors, capacitor size is usually determined by the capacity needed to prevent V_{SOAR} from causing problems during load transients. Generally, once enough capacitance is added to meet the overshoot requirement, undershoot at the rising load edge is no longer a problem.

Input Capacitor Selection

The input capacitor must meet the ripple current requirement (I_{RMS}) imposed by the switching currents. The I_{RMS} requirements of an individual regulator can be determined by the following equation:

$$I_{RMS} = \left(\frac{I_{LOAD}}{V_{IN}} \right) \sqrt{V_{OUT}(V_{IN} - V_{OUT})}$$

The worst-case RMS current requirement occurs when operating with $V_{IN} = 2V_{OUT}$. At this point, the above equation simplifies to $I_{RMS} = 0.5 \times I_{LOAD}$. However, the MAX17017 uses an interleaved fixed-frequency architecture, which helps reduce the overall input RMS current on the INBC input supply.

For the MAX17017 system (INA) supply, nontantalum chemistries (ceramic, aluminum, or OS-CON) are preferred due to their resistance to inrush surge currents typical of systems with a mechanical switch or connector in series with the input. For the MAX17017 INBC input supply, ceramic capacitors are preferred on input due to their low parasitic inductance, which helps reduce the high-frequency ringing on the INBC supply when the internal MOSFETs are turned off. Choose an input capacitor that exhibits less than +10°C temperature rise at the RMS input current for optimal circuit longevity.

BST Capacitors

The boost capacitors (C_{BST}) must be selected large enough to handle the gate charging requirements of the high-side MOSFETs. For these low-power applications, 0.1μF ceramic capacitors work well.

Regulator A Power-MOSFET Selection

Most of the following MOSFET guidelines focus on the challenge of obtaining high load-current capability when using high-voltage (> 20V) AC adapters. Low-current applications usually require less attention.

The high-side MOSFET (N_H) must be able to dissipate the resistive losses plus the switching losses at both $V_{IN(MIN)}$ and $V_{IN(MAX)}$. Ideally, the losses at $V_{IN(MIN)}$ should be roughly equal to the losses at $V_{IN(MAX)}$, with lower losses in between. If the losses at $V_{IN(MIN)}$ are significantly higher, consider increasing the size of N_H . Conversely, if the losses at $V_{IN(MAX)}$ are significantly higher, consider reducing the size of N_H . If V_{IN} does not vary over a wide range, maximum efficiency is achieved by selecting a high-side MOSFET (N_H) that has conduction losses equal to the switching losses.

Choose a low-side MOSFET (N_L) that has the lowest possible on-resistance ($R_{DS(ON)}$), comes in a moderate-sized package (i.e., 8-pin SO, DPAK, or D²PAK),

Quad-Output Controller for Low-Power Architecture

and is reasonably priced. Ensure that the MAX17017 DLA gate driver can supply sufficient current to support the gate charge and the current injected into the parasitic drain-to-gate capacitor caused by the high-side MOSFET turning on; otherwise, cross-conduction problems might occur. Switching losses are not an issue for the low-side MOSFET since it is a zero-voltage switched device when used in the step-down topology.

Power-MOSFET Dissipation

Worst-case conduction losses occur at the duty factor extremes. For the high-side MOSFET (N_H), the worst-case power dissipation due to resistance occurs at minimum input voltage:

$$PD(N_H \text{ Resistive}) = \left(\frac{V_{OUT}}{V_{IN}} \right) (I_{LOAD})^2 R_{DS(ON)}$$

Generally, use a small high-side MOSFET to reduce switching losses at high input voltages. However, the $R_{DS(ON)}$ required to stay within package power-dissipation limits often limits how small the MOSFET can be. The optimum occurs when the switching losses equal the conduction ($R_{DS(ON)}$) losses. High-side switching losses do not become an issue until the input is greater than approximately 15V.

Calculating the power dissipation in high-side MOSFETs (N_H) due to switching losses is difficult, since it must allow for difficult-to-quantify factors that influence the turn-on and turn-off times. These factors include the internal gate resistance, gate charge, threshold voltage, source inductance, and PC board (PCB) layout characteristics. The following switching loss calculation provides only a very rough estimate and is no substitute for breadboard evaluation, preferably including verification using a thermocouple mounted on N_H :

$$PD(N_H \text{ Switching}) = \left(\frac{I_{LOAD} Q_{G(SW)}}{I_{GATE}} + \frac{C_{OSS} V_{IN(MAX)}}{2} \right) V_{IN(MAX)} f_{SW}$$

where C_{OSS} is the output capacitance of N_H , $Q_{G(SW)}$ is the charge needed to turn on the N_H MOSFET, and I_{GATE} is the peak gate-drive source/sink current (1A typ).

Switching losses in the high-side MOSFET can become a heat problem when maximum AC adapter voltages are applied, due to the squared term in the switching-loss equation ($C \times V_{IN}^2 \times f_{SW}$). If the high-side MOSFET chosen for adequate $R_{DS(ON)}$ at low battery voltages becomes extraordinarily hot when subjected to $V_{IN(MAX)}$, consider choosing another MOSFET with lower parasitic capacitance.

For the low-side MOSFET (N_L) the worst-case power dissipation always occurs at maximum battery voltage:

$$PD(N_L \text{ Resistive}) = \left[1 - \left(\frac{V_{OUT}}{V_{IN(MAX)}} \right) \right] (I_{LOAD})^2 R_{DS(ON)}$$

The absolute worst case for MOSFET power dissipation occurs under heavy overload conditions that are greater than $I_{LOAD(MAX)}$, but are not high enough to exceed the current limit and cause the fault latch to trip. To protect against this possibility, “overdesign” the circuit to tolerate:

$$I_{LOAD} = I_{LIMIT} - \left(\frac{\Delta I_{INDUCTOR}}{2} \right)$$

where I_{LIMIT} is the peak current allowed by the current-limit circuit, including threshold tolerance and sense-resistance variation. The MOSFETs must have a relatively large heatsink to handle the overload power dissipation.

Choose a Schottky diode (D_L) with a forward voltage drop low enough to prevent the low-side MOSFET's body diode from turning on during the dead time. As a general rule, select a diode with a DC current rating equal to 1/3 the load current. This diode is optional and can be removed if efficiency is not critical.

Regulator A Step-Up Converter Configuration

Regulator A can be configured as a step-up converter (Figure 4). When $\overline{UP/DN}$ is pulled low, regulator A operates as a step-up converter (for 1 Li+ cell applications). It typically generates a 5V output voltage from a 3V to 5V battery input voltage. The step-up converter uses a current-mode architecture; the difference between the feedback voltage and a 1V reference signal generates an error signal that programs the peak inductor current to regulate the output voltage. The step-up converter is internally compensated, reducing external component requirements.

When regulator A is configured as a step-up converter, \overline{SHDN} should be connected to GND. ONA is the master enable switch. ONA rising enables REF and the bias block. Connect LDO5 and INLDO together with OUTA and connect BYP to either OUTA or INA.

At light loads, efficiency is enhanced by an idle mode in which switching occurs only as needed to service the load. This idle-mode threshold is determined by comparing the current-sense signal to an internal reference. In idle mode, the synchronous rectifier shuts off once the current-sense voltage (CSPA - CSNA) drops below 1mV, preventing negative inductor current.