



Chipsmall Limited consists of a professional team with an average of over 10 year of expertise in the distribution of electronic components. Based in Hongkong, we have already established firm and mutual-benefit business relationships with customers from,Europe,America and south Asia,supplying obsolete and hard-to-find components to meet their specific needs.

With the principle of “Quality Parts,Customers Priority,Honest Operation,and Considerate Service”,our business mainly focus on the distribution of electronic components. Line cards we deal with include Microchip,ALPS,ROHM,Xilinx,Pulse,ON,Everlight and Freescale. Main products comprise IC,Modules,Potentiometer,IC Socket,Relay,Connector.Our parts cover such applications as commercial,industrial, and automotives areas.

We are looking forward to setting up business relationship with you and hope to provide you with the best service and solution. Let us make a better world for our industry!



## Contact us

Tel: +86-755-8981 8866 Fax: +86-755-8427 6832

Email & Skype: info@chipsmall.com Web: www.chipsmall.com

Address: A1208, Overseas Decoration Building, #122 Zhenhua RD., Futian, Shenzhen, China





# Low-Input-Voltage, 300mA LDO Regulators with **RESET** in SOT and TDFN

## General Description

The MAX1963A/MAX1976A low-dropout linear regulators operate from a +1.62V to +3.6V supply and deliver a guaranteed 300mA continuous load current with a low 100mV dropout. The high-accuracy ( $\pm 0.5\%$ ) output voltage is preset to an internally trimmed voltage in the +0.75V to +3.0V range. An active-low, open-drain reset output remains asserted for at least 2.2ms (MAX1963A) or 70ms (MAX1976A) after the output voltage reaches regulation. These devices are offered in thin SOT23 and thin DFN packages. An internal pMOS pass transistor allows the low supply current to remain independent of load and dropout voltage, making these devices ideal for portable battery-powered equipment.

## Applications

Notebook/Handheld Computers  
Cellular/Smart/PDA Phones  
DSC, CD/MP3 Players  
PCMCIA Cards

## Pin Configurations

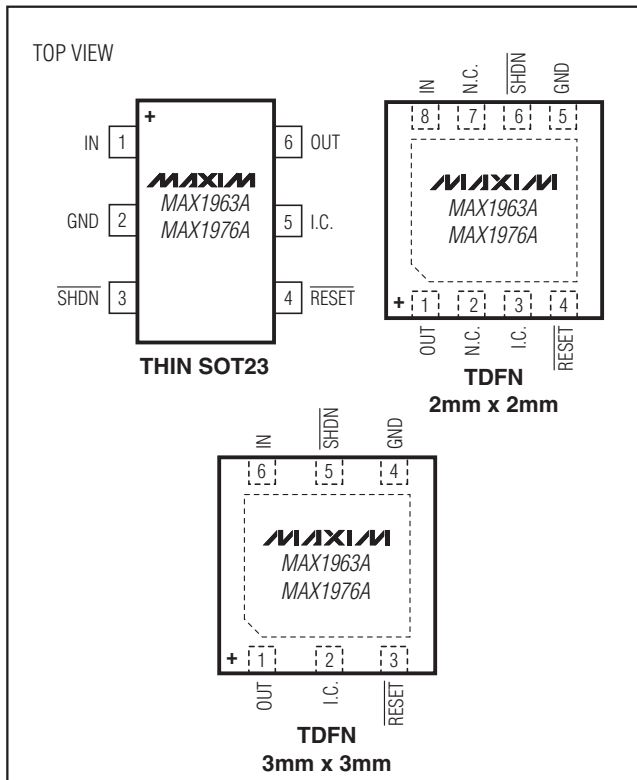

Selector Guide appears at end of data sheet.

## Features

- ◆ Low 1.62V Minimum Input Voltage
- ◆ Guaranteed 300mA Output Current
- ◆  $\pm 2.5\%$  Accuracy Over Load/Line/Temp
- ◆ Low 100mV Dropout at 300mA Load
- ◆ 2.2ms (MAX1963A) or 70ms (MAX1976A) RESET Output Flag
- ◆ Supply Current Independent of Load and Dropout Voltage
- ◆ Logic-Controlled Shutdown
- ◆ Thermal-Overload and Short-Circuit Protection
- ◆ Preset Output Voltages (0.75V to 3.0V)
- ◆ Tiny 6-Pin Thin SOT23 Package (<1.1mm High)
- ◆ TDFN Package (<0.8mm High)

## Ordering Information

PART*	TEMP RANGE	PIN-PACKAGE
MAX1963AEZT___+T	-40°C to +85°C	6 Thin SOT23-6
MAX1963AETT___+T	-40°C to +85°C	6 TDFN-6 3mm x 3mm
MAX1963AETA___+T	-40°C to +85°C	8 TDFN-8 2mm x 2mm
MAX1976AEZT___+T	-40°C to +85°C	6 Thin SOT23-6
MAX1976AETT___+T	-40°C to +85°C	6 TDFN-6 3mm x 3mm
MAX1976AETA___+T	-40°C to +85°C	8 TDFN-8 2mm x 2mm
MAX1976AETT___N+T	-40°C to +85°C	6 TDFN-6 3mm x 3mm

\*Insert the desired three-digit suffix (see the Selector Guide) into the blanks to complete the part number. Contact the factory for other output voltages.

+Denotes a lead(Pb)-free/RoHS-compliant package.

/N denotes an automotive-qualified part.

## Typical Operating Circuit

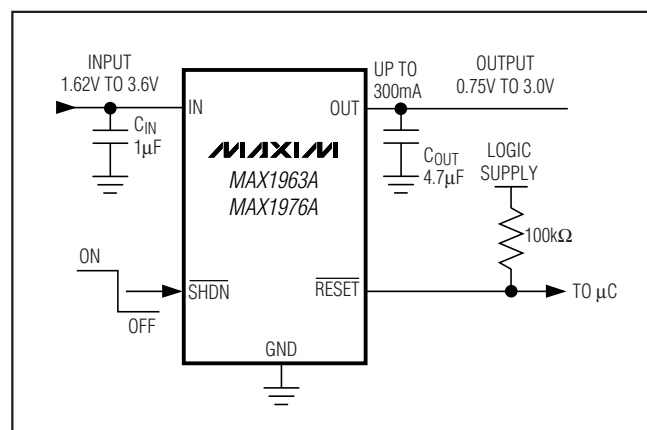

MAX1963A/MAX1976A

# Low-Input-Voltage, 300mA LDO Regulators with **RESET** in SOT and TDFN

## ABSOLUTE MAXIMUM RATINGS

IN,  $\overline{\text{SHDN}}$ ,  $\overline{\text{RESET}}$  to GND .....-0.3V to +4.0V  
 OUT to GND .....-0.3V to ( $V_{\text{IN}} + 0.3\text{V}$ )  
 Output Short-Circuit Duration.....Continuous  
 Continuous Power Dissipation (multilayer board,  $T_A = +70^\circ\text{C}$ )  
   6-Pin SOT23 (derate 9.1mW/ $^\circ\text{C}$  above  $+70^\circ\text{C}$ ).....727mW  
   6-Pin TDFN (derate 23.8mW/ $^\circ\text{C}$  above  $+70^\circ\text{C}$ ) .....1904.8mW  
   8-Pin TDFN (derate 11.9mW/ $^\circ\text{C}$  above  $+70^\circ\text{C}$ ) .....953.5mW

Operating Temperature Range .....-40 $^\circ\text{C}$  to +85 $^\circ\text{C}$   
 Junction Temperature ..... +150 $^\circ\text{C}$   
 Storage Temperature Range .....-65 $^\circ\text{C}$  to +150 $^\circ\text{C}$   
 Lead Temperature (soldering, 10s) .....+300 $^\circ\text{C}$   
 Soldering Temperature (reflow) .....+260 $^\circ\text{C}$

Stresses beyond those listed under "Absolute Maximum Ratings" may cause permanent damage to the device. These are stress ratings only, and functional operation of the device at these or any other conditions beyond those indicated in the operational sections of the specifications is not implied. Exposure to absolute maximum rating conditions for extended periods may affect device reliability.

## ELECTRICAL CHARACTERISTICS

( $V_{\text{IN}} = (V_{\text{OUT}} + 0.5\text{V})$  or 1.8V, whichever is greater;  $\overline{\text{SHDN}} = \text{IN}$ ,  $C_{\text{IN}} = 1\mu\text{F}$ ,  $C_{\text{OUT}} = 4.7\mu\text{F}$ ,  $T_A = -40^\circ\text{C}$  to  $+85^\circ\text{C}$ , unless otherwise noted. Typical values are at  $T_A = +25^\circ\text{C}$ .) (Note 1)

PARAMETER	SYMBOL	CONDITIONS	MIN	TYP	MAX	UNITS
Input Voltage	$V_{\text{IN}}$		1.62		3.60	V
Input Undervoltage Lockout	$V_{\text{UVLO}}$	$V_{\text{IN}}$ rising or falling (180mV typical hysteresis)	1.30		1.60	V
Output Voltage Accuracy		$I_{\text{OUT}} = 1\text{mA}$ to 300mA, $V_{\text{IN}} = (V_{\text{OUT}} + 0.5\text{V})$ to +3.6V	-2.5	$\pm 0.5$	+2.5	%
Maximum Output Current	$I_{\text{OUT}}$	Continuous	300			mARMS
Current Limit	$I_{\text{LIM}}$	$V_{\text{OUT}} = 96\%$ of nominal value	450	550	650	mA
Ground Current	$I_{\text{Q}}$	No load		70	140	$\mu\text{A}$
		$I_{\text{OUT}} = 300\text{mA}$		90		
		Dropout (Note 2)		70		
Dropout Voltage	$V_{\text{IN}} - V_{\text{OUT}}$	$I_{\text{OUT}} = 300\text{mA}$ , $V_{\text{OUT}} \geq 1.8\text{V}$ (Note 2)		100	200	mV
Load Regulation	$\Delta V_{\text{LDR}}$	$I_{\text{OUT}} = 1\text{mA}$ to 300mA		0.02	0.3	%
Line Regulation	$\Delta V_{\text{LNR}}$	$V_{\text{IN}} = (V_{\text{OUT}} + 0.5\text{V})$ to +3.6V, $I_{\text{OUT}} = 1\text{mA}$	-0.15	+0.01	+0.15	%/V
Output Noise		10Hz to 100kHz, $I_{\text{OUT}} = 10\text{mA}$ , $V_{\text{OUT}} = 1.5\text{V}$		86		$\mu\text{VRMS}$
PSRR		$f < 1\text{kHz}$ , $I_{\text{OUT}} = 10\text{mA}$		70		dB

### SHUTDOWN

Shutdown Supply Current	$I_{\text{OFF}}$	$\overline{\text{SHDN}} = \text{GND}$	$T_A = +25^\circ\text{C}$	0.001	1	$\mu\text{A}$
			$T_A = +85^\circ\text{C}$		0.01	
$\overline{\text{SHDN}}$ Input Logic Levels	$V_{\text{IH}}$	$V_{\text{IN}} = 1.62\text{V}$ to 3.6V	1.4		V	
	$V_{\text{IL}}$	$V_{\text{IN}} = 1.62\text{V}$ to 3.6V	0.6			
$\overline{\text{SHDN}}$ Input Bias Current	$I_{\overline{\text{SHDN}}}$	$V_{\overline{\text{SHDN}}} = 0\text{V}$ or 3.6V	$T_A = +25^\circ\text{C}$	1	100	nA
			$T_A = +85^\circ\text{C}$	5		
Turn-On Delay		From $\overline{\text{SHDN}}$ high to OUT high, $V_{\text{OUT}} = 1.8\text{V}$		90		$\mu\text{s}$

# Low-Input-Voltage, 300mA LDO Regulators with RESET in SOT and TDFN

MAX1963A/MAX1976A

## ELECTRICAL CHARACTERISTICS (continued)

( $V_{IN} = (V_{OUT} + 0.5V)$  or 1.8V, whichever is greater;  $\overline{SHDN} = IN$ ,  $C_{IN} = 1\mu F$ ,  $C_{OUT} = 4.7\mu F$ ,  $T_A = -40^\circ C$  to  $+85^\circ C$ , unless otherwise noted. Typical values are at  $T_A = +25^\circ C$ .) (Note 1)

PARAMETER	SYMBOL	CONDITIONS	MIN	TYP	MAX	UNITS	
<b>RESET OUTPUT</b>							
Reset Threshold Accuracy		$V_{OUT}$ falling (1.7% typical hysteresis)	80	82.5	85	% $V_{OUT}$	
$\overline{RESET}$ Output Low Voltage	$V_{OL}$	$I_{\overline{RESET}} = 100\mu A$		1	100	mV	
		$V_{IN} = +1.0V$ , $I_{\overline{RESET}} = 100\mu A$		30	400		
$\overline{RESET}$ Output High Leakage	$I_{OH}$	$V_{\overline{RESET}} = 3.6V$ , $\overline{RESET}$ not asserted	$T_A = +25^\circ C$	0.001	1	$\mu A$	
			$T_A = +85^\circ C$	0.01			
Reset Delay	$t_{RP}$	From $V_{OUT}$ high to $\overline{RESET}$ rising	MAX1963A	2.2	3.2	5.5	ms
			MAX1976A	70	100	160	
<b>THERMAL PROTECTION</b>							
Thermal-Shutdown Temperature	$T_{SHDN}$			+165		$^\circ C$	
Thermal-Shutdown Hysteresis	$\Delta T_{SHDN}$			15		$^\circ C$	

**Note 1:** Limits are 100% production tested at  $T_A = +25^\circ C$ . Limits over the operating temperature range are guaranteed by design.

**Note 2:** The dropout voltage is defined as  $V_{IN} - V_{OUT}$ , when  $V_{OUT}$  is 4% lower than the value of  $V_{OUT}$  when  $V_{IN} = V_{OUT} + 0.5V$ .

## Typical Operating Characteristics

( $V_{IN} = (V_{OUT} + 0.5V)$  or 1.8V, whichever is greater;  $\overline{SHDN} = IN$ ,  $C_{IN} = 1\mu F$ ,  $C_{OUT} = 4.7\mu F$ ,  $T_A = +25^\circ C$ , unless otherwise noted.)

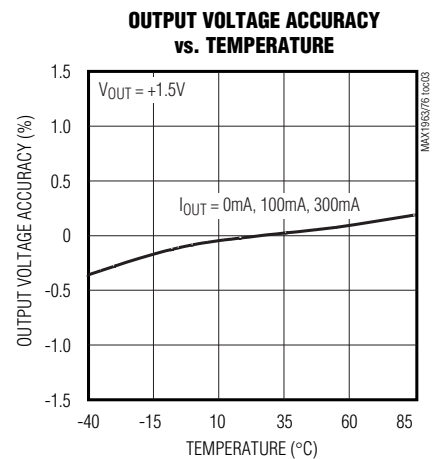
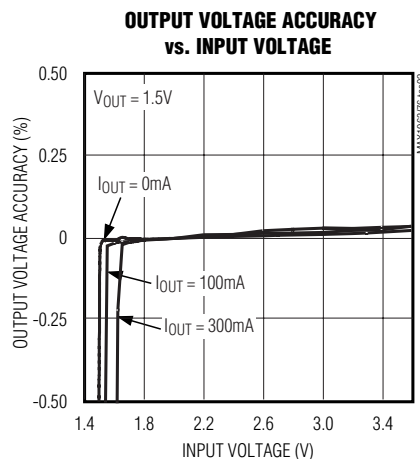
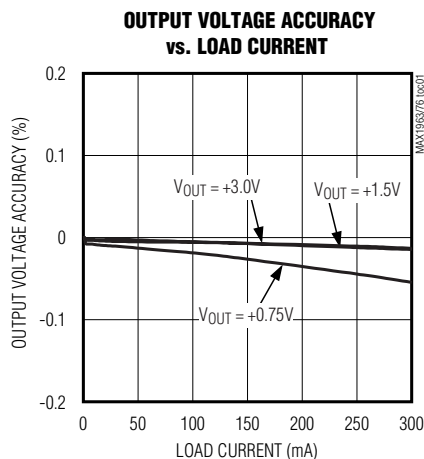

# Low-Input-Voltage, 300mA LDO Regulators with RESET in SOT and TDFN

## Typical Operating Characteristics (continued)

( $V_{IN} = (V_{OUT} + 0.5V)$  or  $1.8V$ , whichever is greater;  $\overline{SHDN} = IN$ ,  $C_{IN} = 1\mu F$ ,  $C_{OUT} = 4.7\mu F$ ,  $T_A = +25^\circ C$ , unless otherwise noted.)

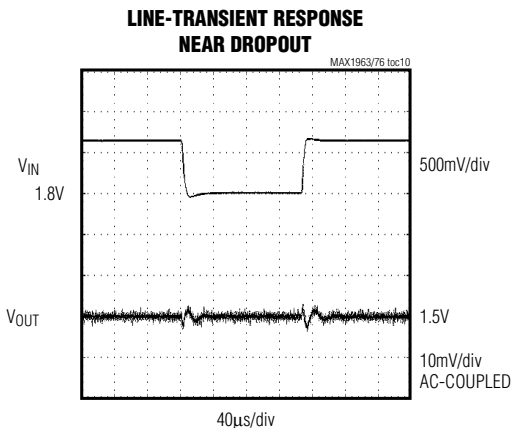
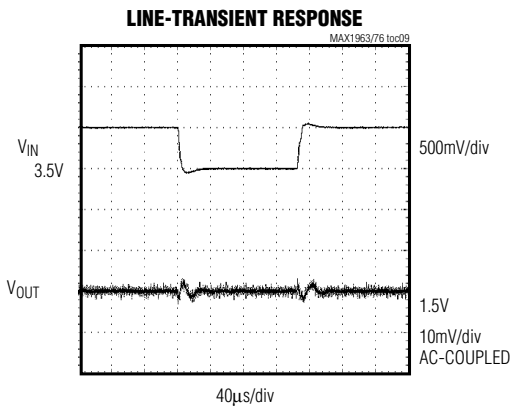
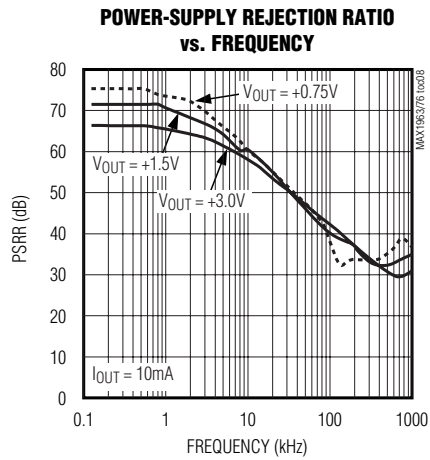
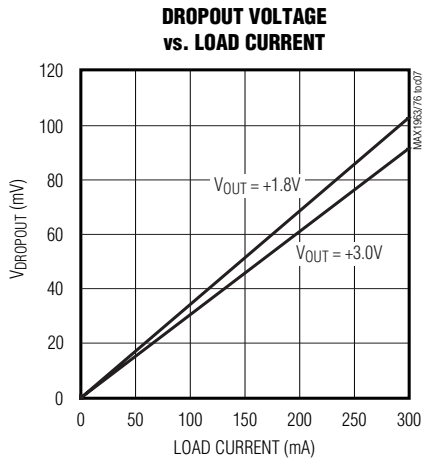
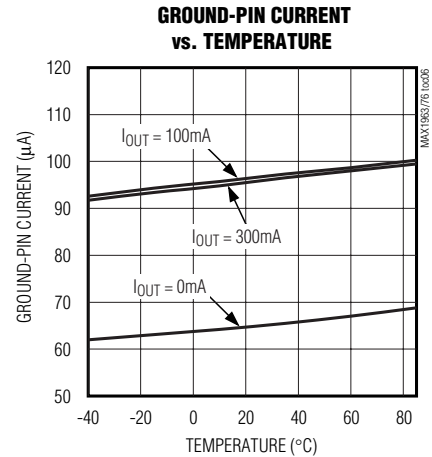
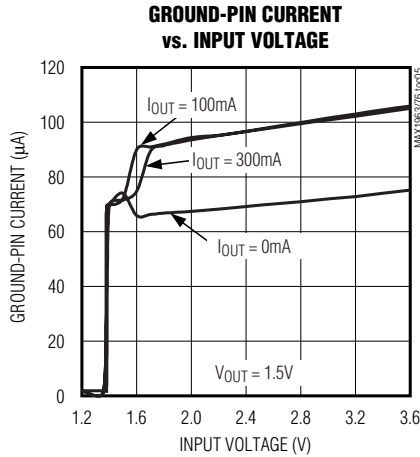
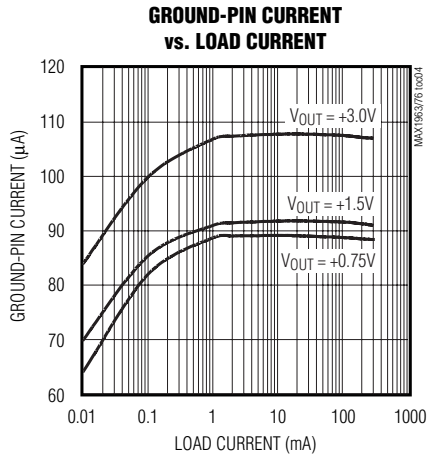

# Low-Input-Voltage, 300mA LDO Regulators with RESET in SOT and TDFN

## Typical Operating Characteristics (continued)

( $V_{IN} = (V_{OUT} + 0.5V)$  or 1.8V, whichever is greater;  $\overline{SHDN} = IN$ ,  $C_{IN} = 1\mu F$ ,  $C_{OUT} = 4.7\mu F$ ,  $T_A = +25^\circ C$ , unless otherwise noted.)

MAX1963A/MAX1976A

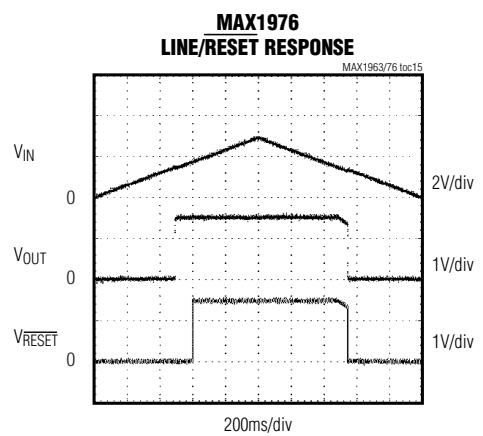
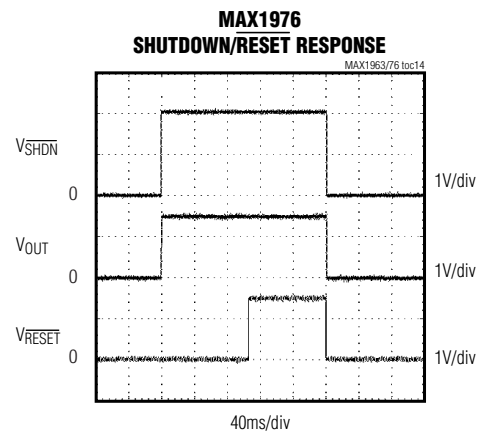
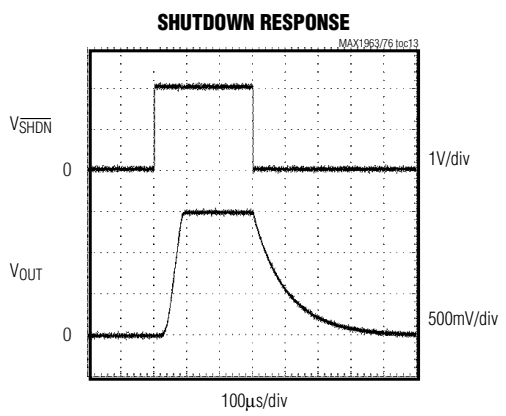
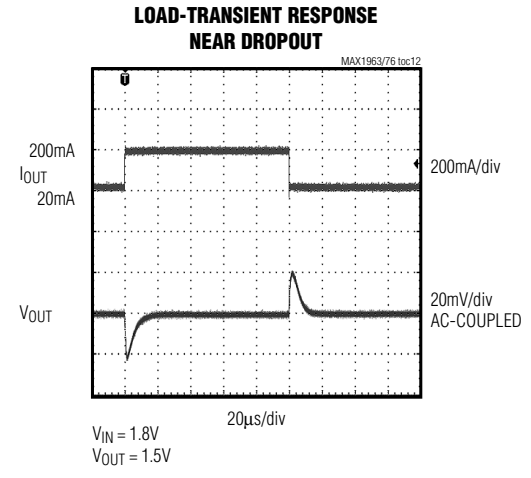
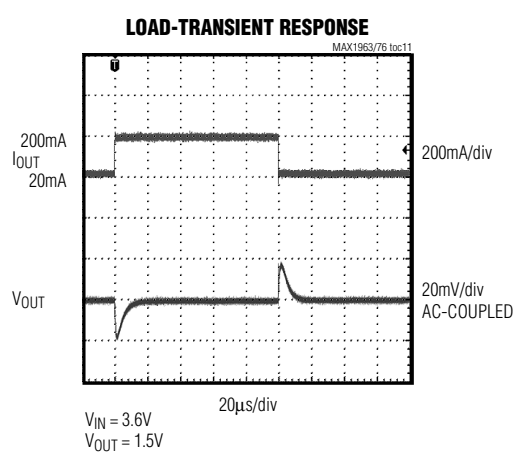

# Low-Input-Voltage, 300mA LDO Regulators with RESET in SOT and TDFN

## Pin Description

PIN			NAME	FUNCTION
THIN SOT23	6-PIN TDFN (3mm x 3mm)	8-PIN TDFN (2mm x 2mm)		
1	6	8	IN	Regulator Input. Supply voltage can range from +1.62V to +3.6V. Bypass IN with at least a 1 $\mu$ F ceramic capacitor to GND (see the <i>Capacitor Selection and Regulator Stability</i> section).
2	—	—	GND	Ground. GND also functions as a heatsink. Solder to a large pad or circuit-board ground plane to maximize SOT23 power dissipation.
—	4	5	GND	Ground
3	5	6	$\overline{\text{SHDN}}$	Active-Low Shutdown Input. A logic-low reduces supply current to below 1 $\mu$ A. Connect to IN or logic-high for normal operation.
4	3	4	$\overline{\text{RESET}}$	Open-Drain, Active-Low Reset Output. $\overline{\text{RESET}}$ rises 3.2ms (MAX1963A) or 100ms (MAX1976A) after the output has achieved regulation. $\overline{\text{RESET}}$ falls immediately if $V_{\text{OUT}}$ drops below 82.5% of its nominal voltage, or if the MAX1963A/MAX1976A are shut down.
5	2	3	I.C.	Internally Connected. Leave unconnected or connect to GND.
6	1	1	OUT	Regulator Output. Sources up to 300mA. Bypass with a 4.7 $\mu$ F low-ESR ceramic capacitor to GND.
—	—	2, 7	N.C.	No Connection. Not internally connected.
—	—	—	EP	Ground (TDFNs only). EP also functions as a heatsink. Solder EP to a large pad or circuit-board ground plane to maximize TDFN power dissipation.

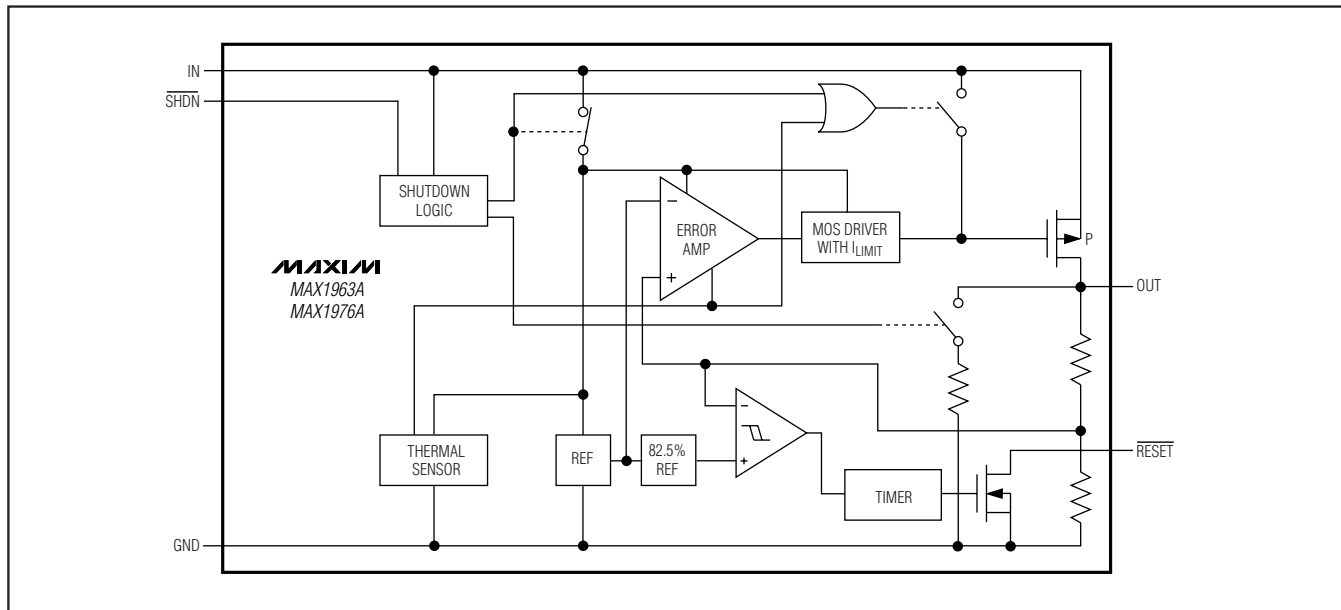

Figure 1. Functional Diagram

# Low-Input-Voltage, 300mA LDO Regulators with **RESET** in SOT and TDFN

## Detailed Description

The MAX1963A/MAX1976A are low-dropout, high-accuracy, low-quiescent-current linear regulators designed primarily for battery-powered applications. These devices supply loads up to 300mA and are available with preset output voltages from +0.75V to +3.0V. As illustrated in Figure 1, the MAX1963A/MAX1976A consist of a reference, an error amplifier, a p-channel pass transistor, an internal feedback voltage-divider, and a power-good comparator.

The reference is connected to the error amplifier, which compares this reference with the feedback voltage and amplifies the difference. If the feedback voltage is lower than the reference voltage, the pass-transistor gate is pulled lower, which allows more current to pass to the output and increases the output voltage. If the feedback voltage is too high, the pass-transistor gate is pulled up, allowing less current to pass to the output.

### Internal p-Channel Pass Transistor

The MAX1963A/MAX1976A feature a 0.33Ω (R<sub>DS(ON)</sub>) p-channel MOSFET pass transistor. Unlike similar designs using pnp pass transistors, p-channel MOSFETs require no base drive, which reduces quiescent current. The pnp-based regulators also waste considerable current in dropout when the pass transistor saturates and use high base-drive currents under large loads. The MAX1963A/MAX1976A do not suffer from these problems and consume only 90μA (typ) of quiescent current under heavy loads, as well as in dropout.

### Shutdown

Pull SHDN low to enter shutdown. During shutdown, the output is disconnected from the input, an internal 1.5kΩ resistor pulls OUT to GND, **RESET** is actively pulled low, and the supply current drops below 1μA.

### RESET Output

The MAX1963A/MAX1976A microprocessor (μP) supervisory circuitry asserts a guaranteed logic-low reset during power-up, power-down, and brownout conditions down to +1V. **RESET** asserts when V<sub>OUT</sub> is below the reset threshold and remains asserted for at least t<sub>RP</sub> after V<sub>OUT</sub> rises above the reset threshold of regulation.

### Current Limit

The MAX1963A/MAX1976A monitor and control the pass transistor's gate voltage, limiting the output current to 450mA (min). If the output exceeds I<sub>LIM</sub>, the MAX1963A/MAX1976A output voltage drops.

### Thermal-Overload Protection

Thermal-overload protection limits total power dissipation in the MAX1963A/MAX1976A. When the junction

temperature exceeds T<sub>J</sub> = +165°C, a thermal sensor turns off the pass transistor, allowing the IC to cool. The thermal sensor turns the pass transistor on again after the junction temperature cools by 15°C, resulting in a pulsed output during continuous thermal-overload conditions. Thermal-overload protection safeguards the MAX1963A/MAX1976A in the event of fault conditions. For continuous operation, do not exceed the absolute maximum junction-temperature rating of T<sub>J</sub> = +150°C.

### Operating Region and Power Dissipation

The MAX1963A/MAX1976A maximum power dissipation depends on the thermal resistance of the IC package and circuit board, the temperature difference between the die junction and ambient air, and the rate of airflow. The power dissipated in the device is P = I<sub>OUT</sub> × (V<sub>IN</sub> - V<sub>OUT</sub>). The maximum allowed power dissipation is:

$$P_{MAX} = (T_{J(MAX)} - T_A) / (\theta_{JC} + \theta_{CA})$$

where (T<sub>J(MAX)</sub> - T<sub>A</sub>) is the temperature difference between the MAX1963A/MAX1976A die junction and the surrounding air, θ<sub>JC</sub> is the thermal resistance of the junction to the case, and θ<sub>CA</sub> is the thermal resistance from the case through the PC board, copper traces, and other materials to the surrounding air. For best heatsinking, expand the copper connected to the exposed paddle or GND.

The MAX1963A/MAX1976A deliver up to 300mA and operate with an input voltage up to +3.6V. However, when using the 6-pin SOT23 version, high output currents can only be sustained when the input-output differential voltage is less than 2V, as shown in Figure 2.

The maximum allowed power dissipation for the 6-pin TDFN is 1.951W at T<sub>A</sub> = +70°C. Figure 3 shows that the maximum input-output differential voltage is not limited by the TDFN package power rating.

## Applications Information

### Capacitor Selection and Regulator Stability

Capacitors are required at the MAX1963A/MAX1976A input and output for stable operation over the full temperature range and with load currents up to 300mA. Connect a 1μF ceramic capacitor between IN and GND and a 4.7μF low-ESR ceramic capacitor between OUT and GND. The input capacitor (C<sub>IN</sub>) lowers the source impedance of the input supply. Use larger output capacitors to reduce noise and improve load-transient response, stability, and power-supply rejection.

The output capacitor's equivalent series resistance (ESR) affects stability and output noise. Use output



# Low-Input-Voltage, 300mA LDO Regulators with **RESET** in SOT and TDFN

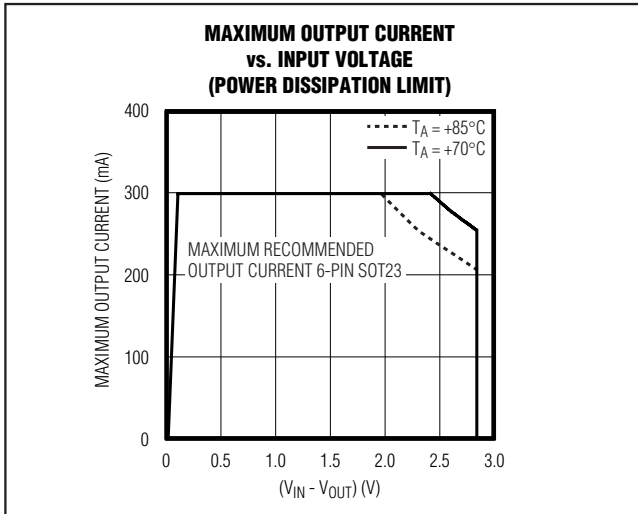

Figure 2. Power Operating Regions for the 6-Pin SOT23: Maximum Output Current vs. Input Voltage

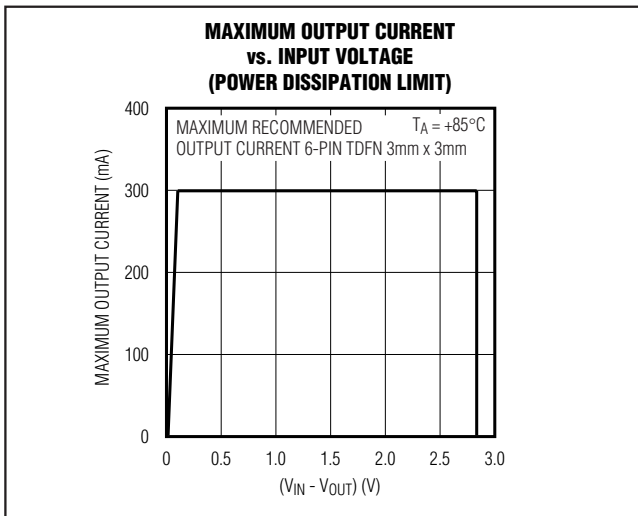

Figure 3. Power Operating Regions for the 6-Pin TDFN: Maximum Output Current vs. Input Voltage

capacitors with an ESR of 30mΩ or less to ensure stability and optimize transient response. Surface-mount ceramic capacitors have very low ESR and are commonly available in values up to 10μF. Connect C<sub>IN</sub> and C<sub>OUT</sub> as close to the MAX1963A/MAX1976A as possible to minimize the impact of PC board trace inductance.

### Noise, PSRR, and Transient Response

The MAX1963A/MAX1976A are designed to operate with low dropout voltages and low quiescent currents in battery-powered systems while still maintaining good noise, transient response, and AC rejection. See the *Typical Operating Characteristics* for a plot of Power-Supply Rejection Ratio (PSRR) versus Frequency. When operating from noisy sources, improved supply-noise rejection and transient response can be achieved by increasing the values of the input and output bypass capacitors and through passive filtering techniques.

The MAX1963A/MAX1976A load-transient response (see the *Typical Operating Characteristics*) shows two components of the output response: a near-zero DC shift from the output impedance due to the load-current change, and the transient response. A typical transient response for a step change in the load current from 20mA to 200mA is 20mV. Increasing the output capacitor's value and decreasing the ESR attenuates the overshoot.

### Input-Output (Dropout) Voltage

A regulator's minimum input-output voltage difference (dropout voltage) determines the lowest usable supply voltage. In battery-powered systems, this determines the useful end-of-life battery voltage. Because the MAX1963A/MAX1976A use a p-channel MOSFET pass transistor, the dropout voltage is a function of drain-to-source on-resistance ( $R_{DS(ON)} = 0.33\Omega$ ) multiplied by the load current (see the *Typical Operating Characteristics*).

$$V_{DROPOUT} = V_{IN} - V_{OUT} = 0.33\Omega \times I_{OUT}$$

The MAX1963A/MAX1976A ground current reduces to 70μA in dropout.

# Low-Input-Voltage, 300mA LDO Regulators with RESET in SOT and TDFN

## Selector Guide

MAX1963A/MAX1976A

VOUT (V)	SUFFIX	MAX1963A TOP MARK			MAX1976A TOP MARK		
		SOT	TDFN (3mm x 3mm)	TDFN (2mm x 2mm)	SOT	TDFN (3mm x 3mm)	TDFN (2mm x 2mm)
0.75	075	<b>AACJ</b>	<b>ALM</b>	—	<b>AACU</b>	<b>ALX</b>	—
0.85	085	—	—	—	<b>AACV</b>	<b>ALY</b>	—
0.90	090	<b>AACK</b>	<b>ALN</b>	—	<b>AACW</b>	<b>ALZ</b>	—
1.00	100	<b>AACL</b>	<b>ALO</b>	—	<b>AACX</b>	<b>AMA</b>	—
1.10	110	<b>AACM</b>	<b>ALP</b>	—	<b>AACY</b>	<b>AMB</b>	—
1.20	120	<b>AACN</b>	<b>ALQ</b>	—	<b>AACZ</b>	<b>AMC</b>	—
1.30	130	<b>AACO</b>	<b>ALR</b>	—	<b>AADA</b>	<b>AMD</b>	<b>AAD</b>
1.50	150	<b>AACP</b>	<b>ALS</b>	—	<b>AADB</b>	<b>AME</b>	<b>AAE</b>
1.60	160	—	—	—	<b>AADC</b>	<b>AMF</b>	—
1.80	180	<b>AACQ</b>	<b>ALT</b>	—	<b>AADD</b>	<b>AMG</b>	—
1.85	185	<b>AACR</b>	<b>ALU</b>	—	<b>AADE</b>	<b>AMH</b>	—
2.50	250	<b>AACS</b>	<b>ALV</b>	—	<b>AADF</b>	<b>AMI</b>	—
2.85	285	—	—	—	<b>AADG</b>	AMJ	—
3.00	300	<b>AACT</b>	<b>ALW</b>	—	<b>AADH</b>	<b>AMK</b>	—
1.20	120/V	—	—	—	—	AUO	—
1.50	150/V	—	—	—	—	AVI	—
1.80	180/V	—	—	—	—	AUP	—

**Note:** Standard voltage options, shown in **bold**, are available. Contact the factory for other output voltages between 1.5V and 4.5V. Minimum order quantity is 15,000 units.

### Chip Information

PROCESS: BiCMOS

### Package Information

For the latest package outline information and land patterns (footprints), go to [www.maxim-ic.com/packages](http://www.maxim-ic.com/packages). Note that a "+", "#", or "-" in the package code indicates RoHS status only. Package drawings may show a different suffix character, but the drawing pertains to the package regardless of RoHS status.

PACKAGE TYPE	PACKAGE CODE	OUTLINE NO.	LAND PATTERN NO.
6 TDFN-EP	T633+2	<a href="#">21-0137</a>	<a href="#">90-0058</a>
6 SOT-23	Z6+1	<a href="#">21-0114</a>	<a href="#">90-0242</a>
8 TDFN-EP	T822+1	<a href="#">21-0168</a>	<a href="#">90-0064</a>

# Low-Input-Voltage, 300mA LDO Regulators with RESET in SOT and TDFN

## Revision History

REVISION NUMBER	REVISION DATE	DESCRIPTION	PAGES CHANGED
0	5/05	Initial release	—
1	5/12	Added lead-free packaging information to the data sheet, updated <i>Selector Guide</i> and <i>Pin Description</i>	1, 6, 9

Maxim cannot assume responsibility for use of any circuitry other than circuitry entirely embodied in a Maxim product. No circuit patent licenses are implied. Maxim reserves the right to change the circuitry and specifications without notice at any time. The parametric values (min and max limits) shown in the Electrical Characteristics table are guaranteed. Other parametric values quoted in this data sheet are provided for guidance.

10 **Maxim Integrated Products, 120 San Gabriel Drive, Sunnyvale, CA 94086 408-737-7600**