



Chipsmall Limited consists of a professional team with an average of over 10 year of expertise in the distribution of electronic components. Based in Hongkong, we have already established firm and mutual-benefit business relationships with customers from,Europe,America and south Asia,supplying obsolete and hard-to-find components to meet their specific needs.

With the principle of “Quality Parts,Customers Priority,Honest Operation,and Considerate Service”,our business mainly focus on the distribution of electronic components. Line cards we deal with include Microchip,ALPS,ROHM,Xilinx,Pulse,ON,Everlight and Freescale. Main products comprise IC,Modules,Potentiometer,IC Socket,Relay,Connector.Our parts cover such applications as commercial,industrial, and automotives areas.

We are looking forward to setting up business relationship with you and hope to provide you with the best service and solution. Let us make a better world for our industry!



## Contact us

Tel: +86-755-8981 8866 Fax: +86-755-8427 6832

Email & Skype: info@chipsmall.com Web: www.chipsmall.com

Address: A1208, Overseas Decoration Building, #122 Zhenhua RD., Futian, Shenzhen, China





# 250MHz to 4000MHz Dual, Analog Voltage Variable Attenuator

**MAX19790**

## General Description

The MAX19790 dual, general-purpose analog voltage variable attenuator (VVA) is designed to interface with 50Ω systems operating in the 250MHz to 4000MHz frequency range. Each attenuator includes a control circuit that provides 22dB of attenuation range with a linear control slope of 10dB/V.

Both attenuators share a common analog control and can be cascaded together to yield 44dB of total dynamic range, with a combined linear control slope of 20dB/V.

The IC is a monolithic device designed on one of Maxim's proprietary SiGe BiCMOS processes. The device operates from a single +5.0V supply and is available in a compact, 36-pin thin QFN package (6mm x 6mm x 0.8mm) with an exposed pad. Electrical performance is guaranteed over the extended -40° to +85°C temperature range.

## Applications

Broadband System Applications, Including Wireless Infrastructure Digital and Spread-Spectrum Communication Systems

WCDMA/LTE, TD-SCDMA/TD-LTE, WiMAX™, cdma2000®, GSM/EDGE, and MMDS Base Stations

VSAT/Satellite Modems

Microwave Terrestrial Links

Lineup Gain Trim

Temperature Compensation Circuits

Automatic Level Control (ALC)

Transmitter Gain Control

Receiver Gain Control

General Test Equipment

## Features

- ◆ 250MHz to 4000MHz RF Frequency Range
- ◆ Integrates Two Analog Attenuators in One Monolithic Device
- ◆ Flexible Attenuation-Control Ranges  
22dB (per Attenuator)  
44dB (Both Attenuators Cascaded)
- ◆ 2.4dB 1500MHz Insertion Loss (per Attenuator)
- ◆ Linear dB/V Analog Control Response Curve Simplifies Automatic Leveling Control and Gain-Trim Algorithms
- ◆ Excellent Attenuation Flatness Over Wide Frequency Ranges and Attenuation Settings
- ◆ Low 7.3mA Supply Current
- ◆ Single +5.0V Supply Voltage

## Ordering Information

PART	TEMP RANGE	PIN-PACKAGE
MAX19790ETX+	-40°C to +85°C	36 Thin QFN-EP*
MAX19790ETX+T	-40°C to +85°C	36 Thin QFN-EP*

+Denotes a lead(Pb)-free/RoHS-compliant package.

\*EP = Exposed pad.

T = Tape and reel.

WiMAX is a trademark of WiMAX Forum.

cdma2000 is a registered trademark of Telecommunications Industry Association.



# 250MHz to 4000MHz Dual, Analog Voltage Variable Attenuator

## ABSOLUTE MAXIMUM RATINGS

V <sub>CC</sub> to GND.....	-0.3V to +5.5V	Storage Temperature Range.....	-65°C to +150°C
CTRL to GND (with V <sub>CC</sub> = +5.0V applied).....	0V to +4.75V	Continuous Power Dissipation (T <sub>C</sub> = +85°C) (Note 1) .....	2.1W
All Other Pins to GND .....	-0.3V to (V <sub>CC</sub> + 0.3V)	θ <sub>JC</sub> (Notes 2, 4).....	+10°C/W
RF Input.....	+20dBm	θ <sub>JA</sub> (Notes 3, 4).....	+35°C/W
Current into CTRL Pin (V <sub>CC</sub> grounded).....	40mA	Lead Temperature (soldering, 10s).....	+300°C
Maximum Junction Temperature.....	+150°C	Soldering Temperature (reflow) .....	+260°C
Operating Temperature Range.....	-40°C to +85°C		

**Note 1:** T<sub>C</sub> is the temperature on the exposed pad of the package. T<sub>A</sub> is the ambient temperature of the device and PCB.

**Note 2:** Based on junction temperature T<sub>J</sub> = T<sub>C</sub> + (θ<sub>JC</sub> × V<sub>CC</sub> × I<sub>CC</sub>). This formula can be used when the temperature of the exposed pad is known while the device is soldered down to a PCB. See the *Applications Information* section for details. The junction temperature must not exceed +150°C.

**Note 3:** Junction temperature T<sub>J</sub> = T<sub>A</sub> + (θ<sub>JA</sub> × V<sub>CC</sub> × I<sub>CC</sub>). This formula can be used when the ambient temperature of the PCB is known. The junction temperature must not exceed +150°C.

**Note 4:** Package thermal resistances were obtained using the method described in JEDEC specification JESD51-7, using a four-layer board. For detailed information on package thermal considerations, refer to [www.maxim-ic.com/thermal-tutorial](http://www.maxim-ic.com/thermal-tutorial).

Stresses beyond those listed under “Absolute Maximum Ratings” may cause permanent damage to the device. These are stress ratings only, and functional operation of the device at these or any other conditions beyond those indicated in the operational sections of the specifications is not implied. Exposure to absolute maximum rating conditions for extended periods may affect device reliability.



**CAUTION!** ESD SENSITIVE DEVICE

## DC ELECTRICAL CHARACTERISTICS

(V<sub>CC</sub> = +4.75V to +5.25V, V<sub>CTRL</sub> = +1.0V to +4.0V, no RF signals applied, all input and output ports terminated with 50Ω, T<sub>C</sub> = -40°C to +85°C, unless otherwise noted. Typical values are at V<sub>CC</sub> = +5.0V, V<sub>CTRL</sub> = +1.0V, T<sub>C</sub> = +25°C, unless otherwise noted.)

PARAMETER	SYMBOL	CONDITIONS	MIN	TYP	MAX	UNITS
<b>SUPPLY</b>						
Supply Voltage	V <sub>CC</sub>		4.75	5.0	5.25	V
Supply Current	I <sub>CC</sub>			7.3	9.5	mA
<b>CONTROL INPUT</b>						
Control Voltage Range	V <sub>CTRL</sub>	(Note 5)	1.0		4.0	V
Control Input Resistance	R <sub>CTRL</sub>		50			kΩ

## RECOMMENDED AC OPERATING CONDITIONS

PARAMETER	SYMBOL	CONDITIONS	MIN	TYP	MAX	UNITS
RF Frequency Range	f <sub>RF</sub>	(Note 6)	250		4000	MHz



# 250MHz to 4000MHz Dual, Analog Voltage Variable Attenuator

**MAX19790**

## AC ELECTRICAL CHARACTERISTICS

(MAX19790 Evaluation Kit, line and connector losses included, **two attenuators in cascade**,  $V_{CC} = 4.75V$  to  $5.25V$ , RF ports are driven from  $50\Omega$  sources, input  $P_{RF} = -10dBm$ ,  $f_{RF} = 950MHz$  to  $2150MHz$ ,  $V_{CTRL} = +1.0V$ ,  $T_C = -40^\circ C$  to  $+85^\circ C$ . Typical values are for  $T_C = +25^\circ C$ ,  $V_{CC} = +5.0V$ , input  $P_{RF} = -10dBm$ ,  $f_{RF} = 1500MHz$ ,  $V_{CTRL} = +1.0V$ , unless otherwise noted.)

PARAMETER	SYMBOL	CONDITIONS		MIN	TYP	MAX	UNITS
Insertion Loss	IL	$T_C = +25^\circ C$	950MHz to 1500MHz		4.4	6.3	dB
			950MHz to 2150MHz		4.4	7.0	
Loss Variation Over Temperature		$T_C = -40^\circ C$ to $+85^\circ C$			0.6		dB
Input $P_{1dB}$	$IP_{1dB}$				23.1		dBm
Input Second-Order Intercept Point	IIP2	$f_{RF1} + f_{RF2}$ term, $f_{RF1} - f_{RF2} = 1MHz$ (Note 7)			69.6		dBm
Input Third-Order Intercept Point	IIP3	$f_{RF1} - f_{RF2} = 1MHz$ (Note 7)			36.3		dBm
Second Harmonic	$2f_{IN}$				72		dBc
Third Harmonic	$3f_{IN}$				77		dBc
Attenuation-Control Range	$A_R$	One attenuator, $V_{CTRL} = +1.0V$ to $+4.0V$ , $T_C = +25^\circ C$			22		dB
		Two attenuators, $V_{CTRL} = +1.0V$ to $+4.0V$ , $T_C = +25^\circ C$	950MHz to 1500MHz	36	44.7		
			950MHz to 2150MHz	33	44.7		
Average Attenuation-Control Slope		$V_{CTRL} = +1.0V$ to $+3.5V$			20.0		dB/V
Maximum Attenuation-Control Slope		$V_{CTRL} = +1.0V$ to $+3.5V$			30.4		dB/V
Attenuation Flatness Over 125MHz Bandwidth (Note 8)		Peak-to-peak for $V_{CTRL} = +1.0V$ to $+3.1V$ , $T_C = +25^\circ C$			0.13	0.89	dB
Switching Time		From 15dB to 0dB attenuation (Note 9)			500		ns
Input Return Loss		All gain settings			25		dB
Output Return Loss		All gain settings			21		dB
Group Delay		Input/output $50\Omega$ lines deembedded			190		ps
Group-Delay Flatness Over 125MHz Bandwidth		Peak-to-peak			10		ps
Group-Delay Change vs. Attenuation Control		$V_{CTRL} = +1.0V$ to $+4.0V$			-175		ps
Insertion Phase Change vs. Attenuation Control		$V_{CTRL} = +1.0V$ to $+4.0V$			82		Degrees

**Note 5:** Operating outside this range for extended periods may affect device reliability. Limit pin input current to 40mA when  $V_{CC}$  is not present (see Table 1 for  $R_4$  value).

**Note 6:** Operation outside this range is possible, but with degraded performance of some parameters. See the *Typical Operating Characteristics*.

**Note 7:**  $f_1 = 1500MHz$ ,  $f_2 = 1501MHz$ ,  $-10dBm$ /tone at attenuator input.

**Note 8:** Guaranteed by design and characterization.

**Note 9:** Switching time is measured from 50% of the control signal to when the RF output settles to  $\pm 1dB$ .

# 250MHz to 4000MHz Dual, Analog Voltage Variable Attenuator

## Typical Operating Characteristics

(MAX19790 Evaluation Kit, two attenuators in cascade,  $V_{CC} = +5.0V$ ,  $P_{RF} = -10dBm$ ,  $T_C = +25^\circ C$ ,  $V_{CTRL} = +1.0V$ , unless otherwise noted.)

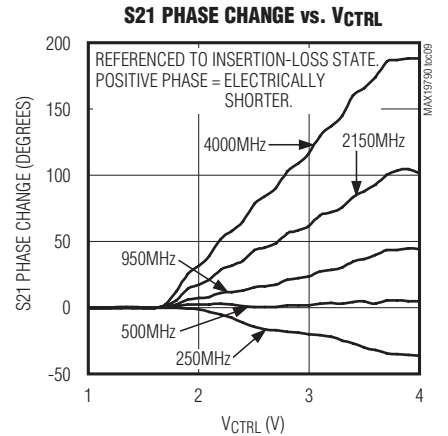
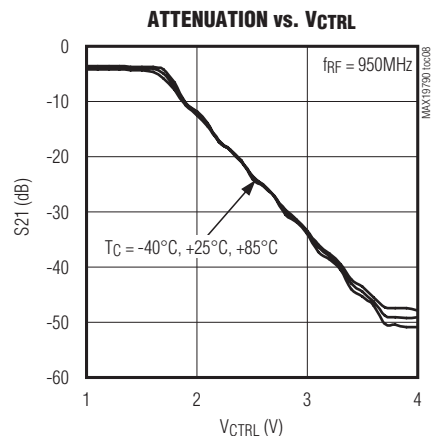
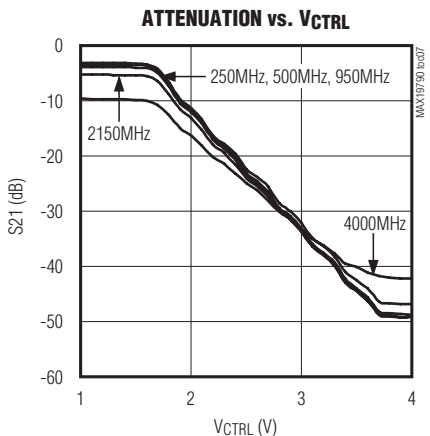
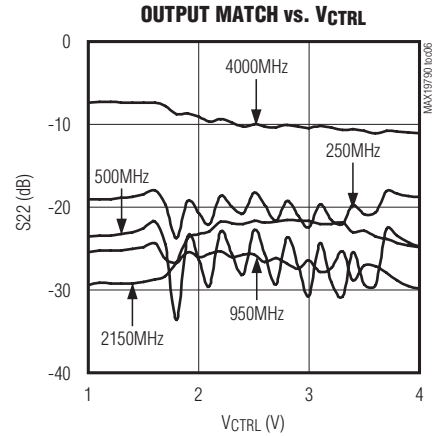
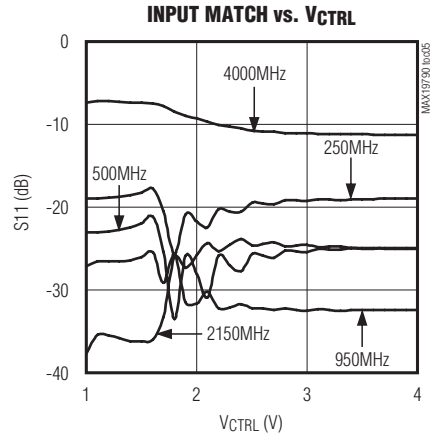
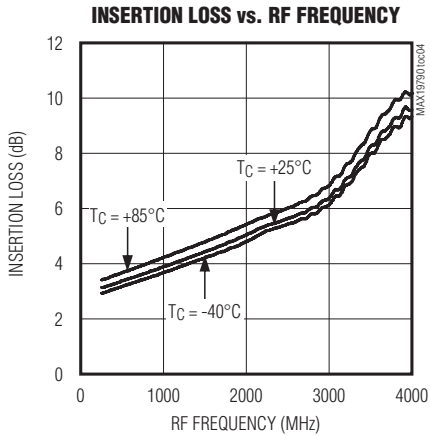
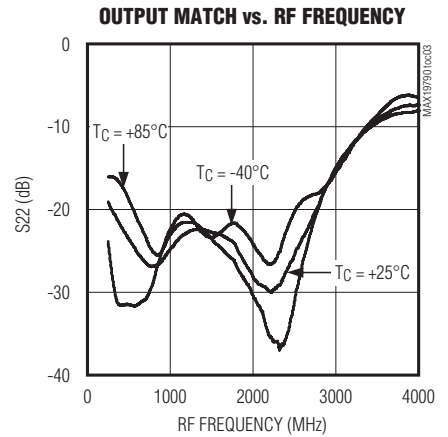
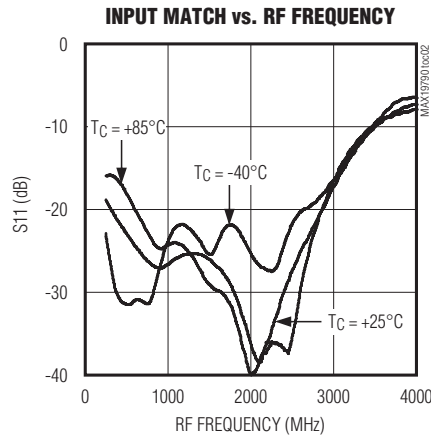
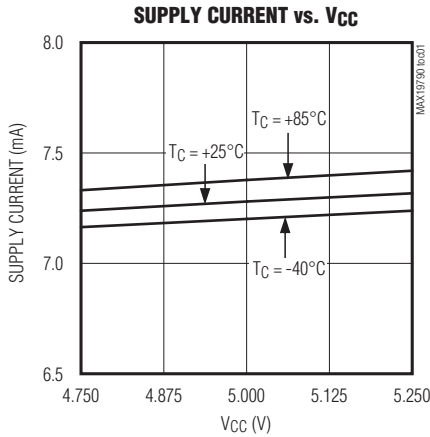

# 250MHz to 4000MHz Dual, Analog Voltage Variable Attenuator

## Typical Operating Characteristics (continued)

(MAX19790 Evaluation Kit, two attenuators in cascade,  $V_{CC} = +5.0V$ ,  $P_{RF} = -10dBm$ ,  $T_C = +25^\circ C$ ,  $V_{CTRL} = +1.0V$ , unless otherwise noted.)

MAX19790

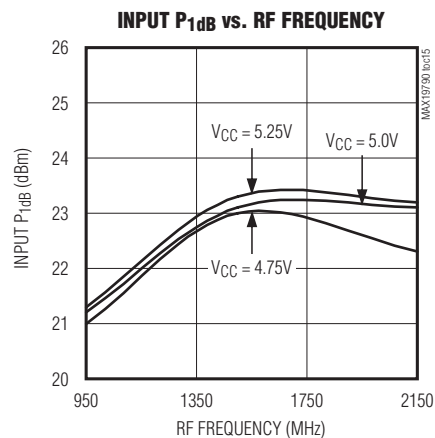
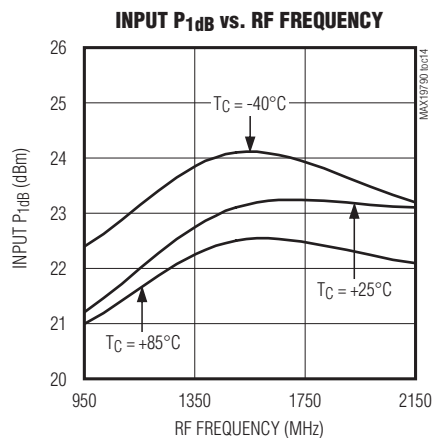
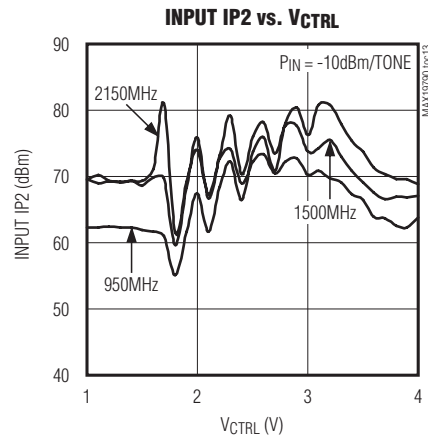
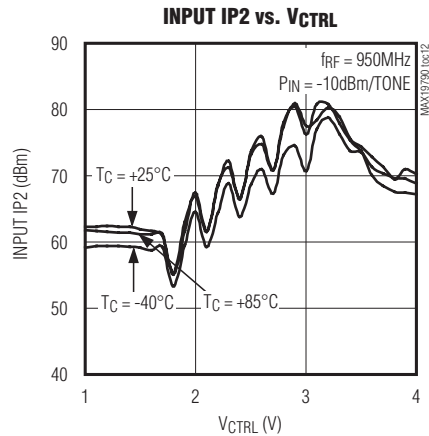
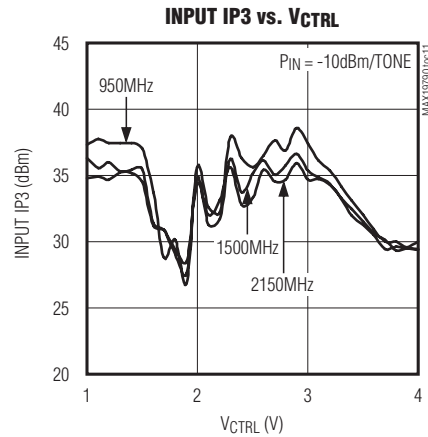
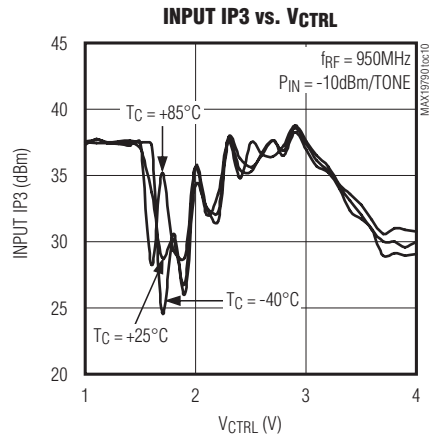

# 250MHz to 4000MHz Dual, Analog Voltage Variable Attenuator

## Typical Operating Characteristics (continued)

(MAX19790 Evaluation Kit, one attenuator connected,  $V_{CC} = +5.0V$ , PRF = -10dBm,  $T_C = +25^\circ C$ ,  $V_{CTRL} = +1.0V$ , unless otherwise noted.)

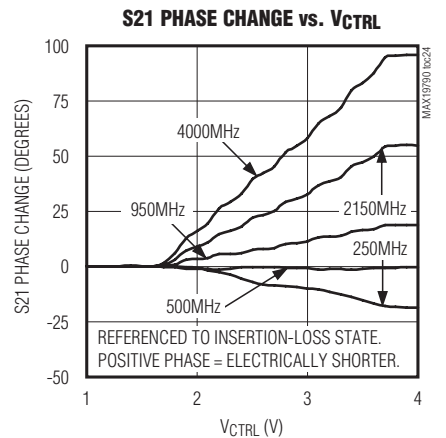
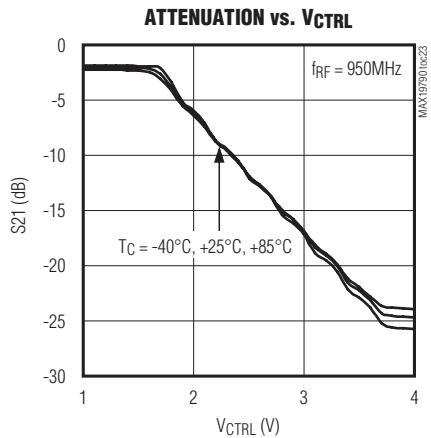
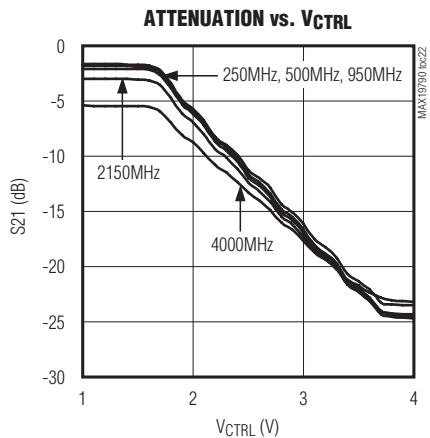
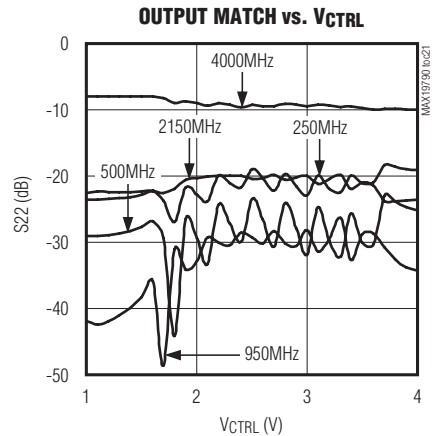
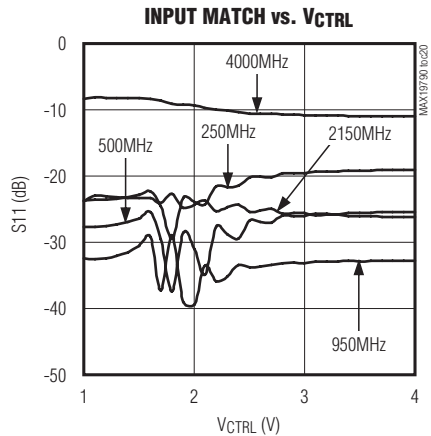
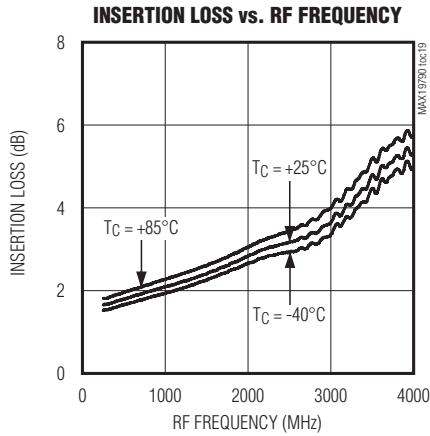
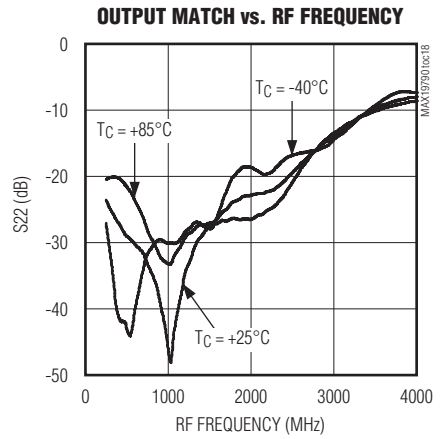
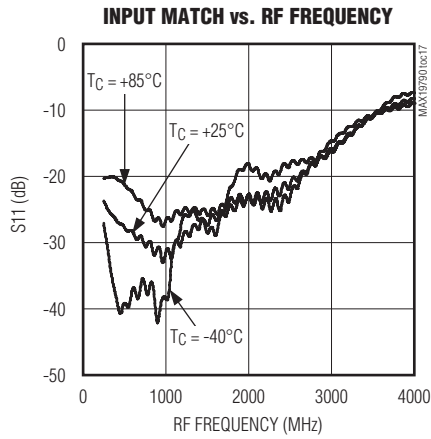
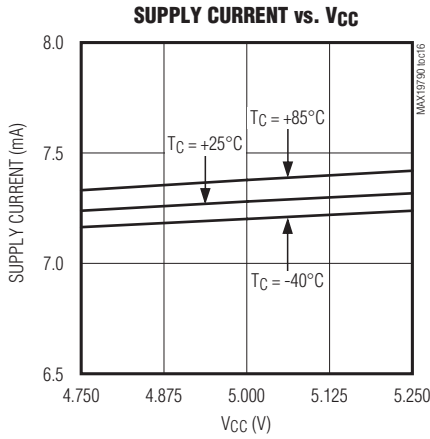

# 250MHz to 4000MHz Dual, Analog Voltage Variable Attenuator

## Typical Operating Characteristics (continued)

(MAX19790 Evaluation Kit, one attenuator connected,  $V_{CC} = +5.0V$ ,  $P_{RF} = -10dBm$ ,  $T_C = +25^\circ C$ ,  $V_{CTRL} = +1.0V$ , unless otherwise noted.)

MAX19790

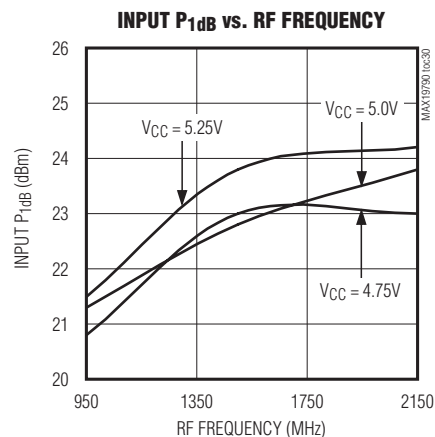
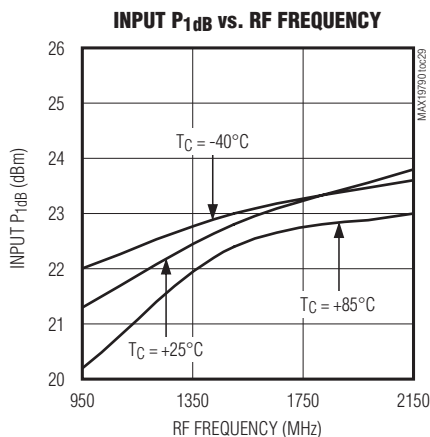
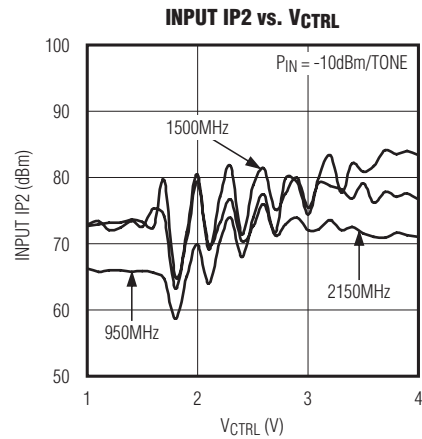
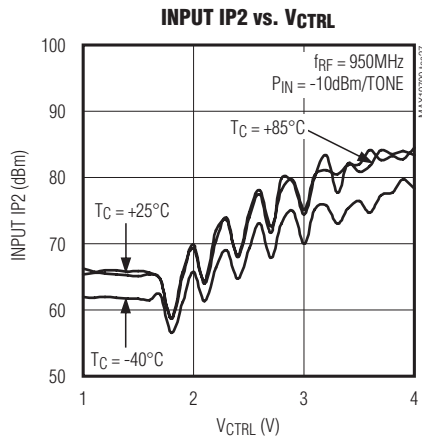
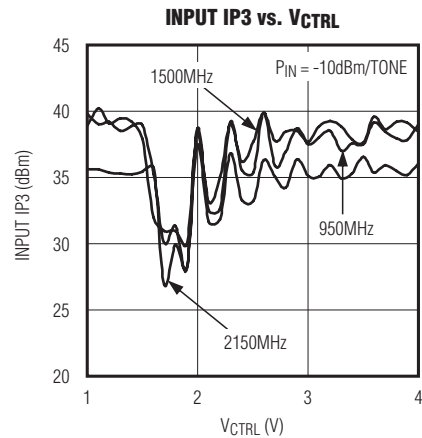
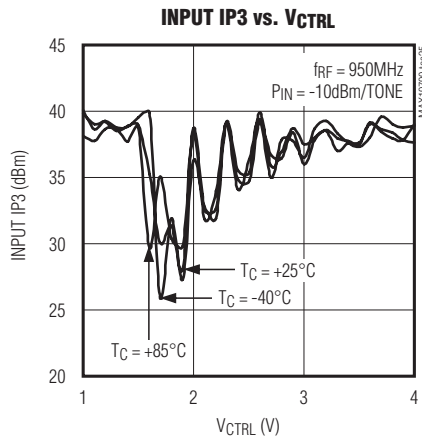



# 250MHz to 4000MHz Dual, Analog Voltage Variable Attenuator

## Pin Configuration/Functional Diagram

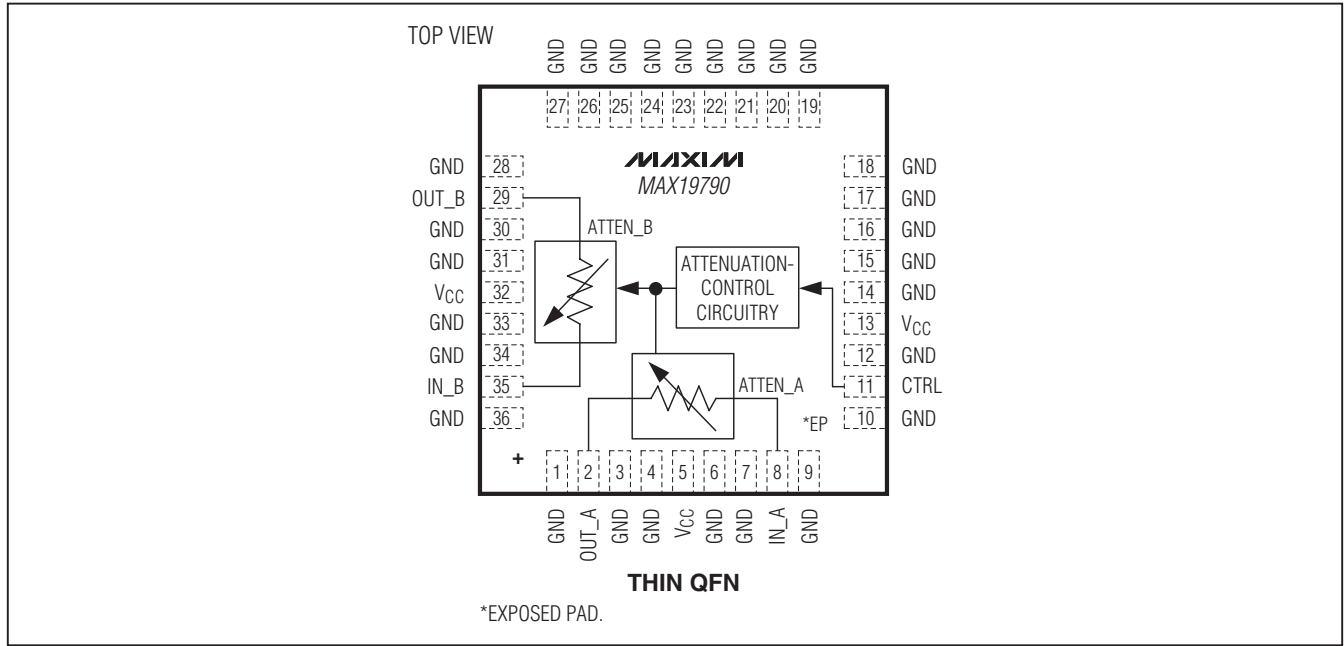

## Pin Description

PIN	NAME	FUNCTION
1, 3, 4, 6, 7, 9, 10, 12, 14–28, 30, 31, 33, 34, 36	GND	Ground. Connect to the board's ground plane using low-inductance layout techniques.
2	OUT_A	Attenuator A Output. Internally matched to 50Ω over the operating frequency band. This pin, if used, requires a DC block. If this attenuator is not used, the pin can be left unconnected.
5, 13, 32	VCC	Power Supply. Bypass to GND with capacitors and resistors as shown in the <i>Typical Application Circuit</i> .
8	IN_A	Attenuator A Input. Internally matched to 50Ω over the operating frequency band. This pin, if used, requires a DC block. If this attenuator is not used, the pin can be left unconnected.
11	CTRL	Analog Attenuator Control Input. VCC must be present unless using a current-limiting resistor, as noted in the <i>Applications Information</i> section. Limit voltages applied to this pin to a +1.0V to +4.0V range with VCC present to ensure device reliability.
29	OUT_B	Attenuator B Output. Internally matched to 50Ω over the operating frequency band. This pin, if used, requires a DC block. If this attenuator is not used, the pin can be left unconnected.
35	IN_B	Attenuator B Input. Internally matched to 50Ω over the operating frequency band. This pin, if used, requires a DC block. If this attenuator is not used, the pin can be left unconnected.
—	EP	Exposed Pad. Internally connected to GND. Solder evenly to the board's ground plane for proper operation.

# 250MHz to 4000MHz Dual, Analog Voltage Variable Attenuator

## Detailed Description

The MAX19790 is a dual, general-purpose analog voltage variable attenuator (VVA) designed to interface with 50 $\Omega$  systems operating in the 250MHz to 4000MHz frequency range. Each attenuator includes a control circuit that provides 22dB of attenuation range with a linear control slope of 10dB/V. Both attenuators share a common analog control and can be cascaded together to yield 44dB of total dynamic range, with a combined linear control slope of 20dB/V.

## Applications Information

### Analog Attenuation Control

A single input voltage at the CTRL pin adjusts the attenuation of the device. Up to 22dB of attenuation-control range is provided per attenuator. At the insertion-loss setting, the attenuator's loss is approximately 2.4dB.

If a larger attenuation-control range is desired, the second on-chip attenuator can be connected in series to provide an additional 22dB of gain-control range.

Note that the CTRL pin simultaneously adjusts both on-chip attenuators. The CTRL input voltage drives a high-impedance load ( $> 50k\Omega$ ). It is suggested that a current-limiting resistor be included in series with this

connection, to limit the input current to less than 40mA, should the control voltage be applied when VCC is not present. A series resistor of greater than 200 $\Omega$  provides complete protection for +5.0V control voltage ranges. **Note:** To ensure the reliability of the device, limit CTRL input voltages to a +1.0V to +4.0V range when VCC is present.

### Layout Considerations

A properly designed PCB is an essential part of any RF/microwave circuit. Keep RF signal lines as short as possible to reduce losses, radiation, and inductance. For best performance, route the ground-pin traces directly to the exposed pad underneath the package. This pad **MUST** be connected to the ground plane of the board by using multiple vias under the device to provide the best RF and thermal conduction path. Solder the exposed pad on the bottom of the device package to a PCB.

### Power-Supply Bypassing

Proper voltage-supply bypassing is essential for high-frequency circuit stability. Bypass each VCC pin with capacitors placed as close as possible to the device. Place the smallest capacitor closest to the device. See the *Typical Application Circuit* and Table 1 for details.

**Table 1. Typical Application Circuit Component Values**

DESIGNATION	QTY	DESCRIPTION
C1, C3, C5	3	220pF $\pm 5\%$ , 50V C0G ceramic capacitors (0402) Murata GRM1555C1H221J
C2, C4	2	0.01 $\mu$ F $\pm 10\%$ , 25V X7R ceramic capacitors (0402) Murata GRM155R71E103K
C6	1	1000pF $\pm 5\%$ , 50V C0G ceramic capacitor (0402) Murata GRM1555C1H102J
C7	1	0.1 $\mu$ F $\pm 10\%$ , 16V X7R ceramic capacitor (0603) Murata GRM188R71C104K
C8*	0	Not installed, ceramic capacitor (0603)

DESIGNATION	QTY	DESCRIPTION
C9	1	22pF $\pm 5\%$ , 50V C0G ceramic capacitor (0402) Murata GRM1555C1H220J
R1, R2	2	10 $\Omega$ $\pm 5\%$ resistors (0402) Any
R3, R4	2	0 $\Omega$ resistors (0402) <b>Note:</b> In cases where V <sub>CTRL</sub> is applied before or removed after VCC, use R4 = 200 $\Omega$ .
U1	1	Analog attenuator IC Maxim MAX19790ETX+ <b>Note:</b> U1 has an exposed pad conductor, which requires it to be solder-attached to a grounded pad on the PCB to ensure a proper electrical/thermal design.

\*C8 can be used to provide additional filtering. Depending on the external driver used on the CTRL line, this capacitance could slow down the response time.

# 250MHz to 4000MHz Dual, Analog Voltage Variable Attenuator

## Exposed Pad RF and Thermal Considerations

The exposed pad (EP) of the device's 36-pin thin QFN package provides a low thermal-resistance path to the die. It is important that the PCB on which the IC is mounted be designed to conduct heat from this contact. In addition, provide the EP with a low-inductance RF ground path for the device.

The EP **MUST** be soldered to a ground plane on the PCB, either directly or through an array of plated via holes. Soldering the pad to ground is also critical for efficient heat transfer. Use a solid ground plane wherever possible.

## Typical Application Circuit

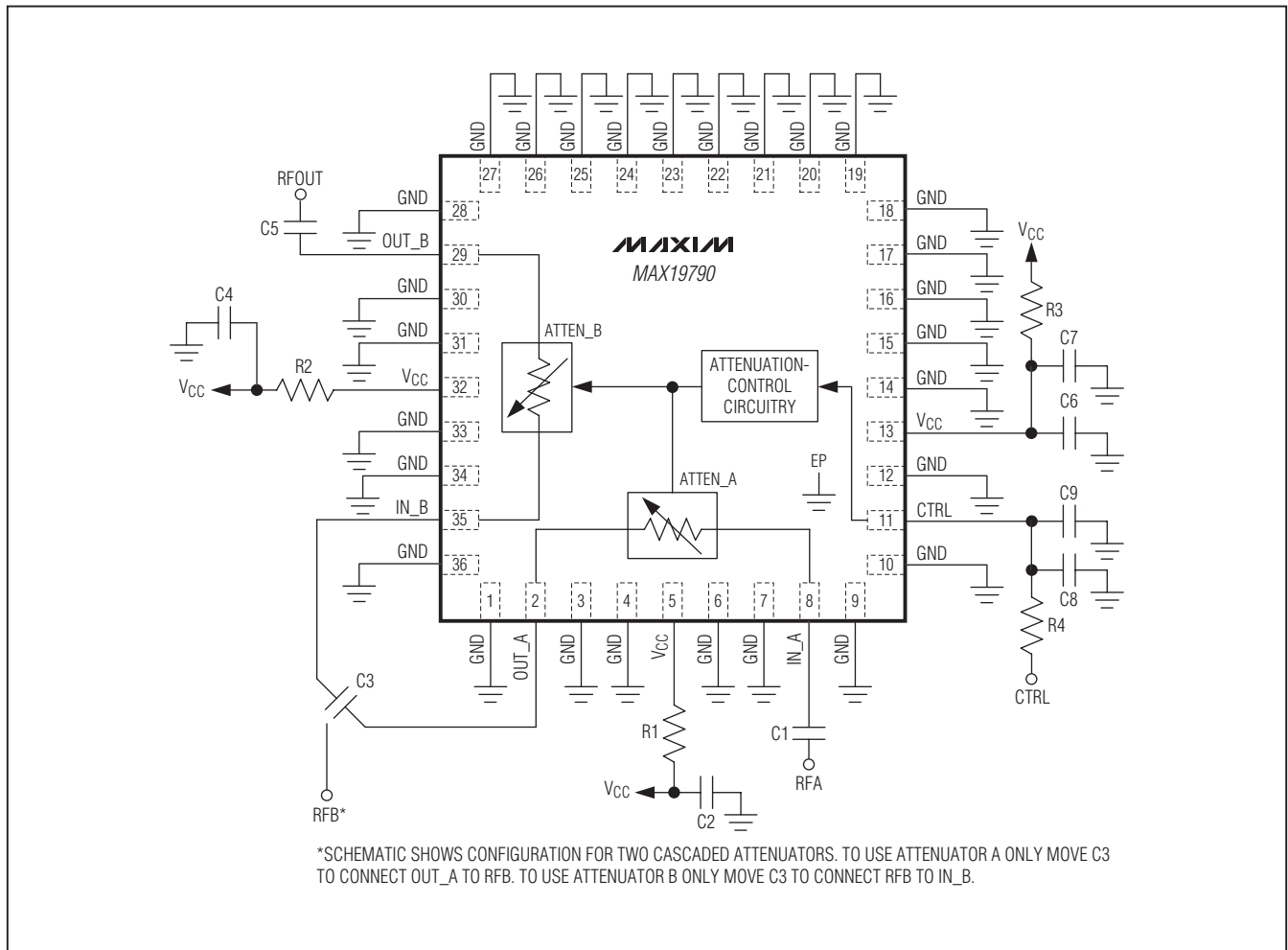

# 250MHz to 4000MHz Dual, Analog Voltage Variable Attenuator

**MAX19790**

## Chip Information

PROCESS: BiCMOS

## Package Information

For the latest package outline information and land patterns, go to [www.maxim-ic.com/packages](http://www.maxim-ic.com/packages). Note that a "+", "#", or "-" in the package code indicates RoHS status only. Package drawings may show a different suffix character, but the drawing pertains to the package regardless of RoHS status.

PACKAGE TYPE	PACKAGE CODE	DOCUMENT NO.
36 Thin QFN-EP	T3666+2	<a href="#">21-0141</a>

*Maxim cannot assume responsibility for use of any circuitry other than circuitry entirely embodied in a Maxim product. No circuit patent licenses are implied. Maxim reserves the right to change the circuitry and specifications without notice at any time.*

**Maxim Integrated Products, 120 San Gabriel Drive, Sunnyvale, CA 94086 408-737-7600** \_\_\_\_\_ 11