



Chipsmall Limited consists of a professional team with an average of over 10 year of expertise in the distribution of electronic components. Based in Hongkong, we have already established firm and mutual-benefit business relationships with customers from,Europe,America and south Asia,supplying obsolete and hard-to-find components to meet their specific needs.

With the principle of “Quality Parts,Customers Priority,Honest Operation,and Considerate Service”,our business mainly focus on the distribution of electronic components. Line cards we deal with include Microchip,ALPS,ROHM,Xilinx,Pulse,ON,Everlight and Freescale. Main products comprise IC,Modules,Potentiometer,IC Socket,Relay,Connector.Our parts cover such applications as commercial,industrial, and automotives areas.

We are looking forward to setting up business relationship with you and hope to provide you with the best service and solution. Let us make a better world for our industry!



## Contact us

Tel: +86-755-8981 8866 Fax: +86-755-8427 6832

Email & Skype: info@chipsmall.com Web: www.chipsmall.com

Address: A1208, Overseas Decoration Building, #122 Zhenhua RD., Futian, Shenzhen, China





# Quad-Channel, Ultra-Low-Noise Amplifier with Digitally Programmable Input Impedance

## General Description

The MAX2034 four-channel, low-power, ultra-low-noise preamplifier is designed for ultrasound and medical instrumentation applications. Each low-noise amplifier has a single-ended input, differential output, a highly accurate 19dB fixed gain, and a wide -3dB bandwidth of 70MHz. The high-gain accuracy of the amplifier allows for exceptional channel-to-channel gain matching, which is necessary for high-performance ultrasound-imaging applications. The MAX2034 also includes an on-chip programmable input impedance feature that allows the device to be compatible with a variety of common source impedances ranging from 50Ω to 1kΩ. The input impedance of each amplifier uses a feedback topology for active impedance matching. The active input impedance matching feature achieves an exceptionally low 2.2dB noise figure with a source and input impedance of 200Ω.

The MAX2034 has excellent dynamic and linearity performance characteristics optimized for all ultrasound-imaging modalities including second harmonic 2D imaging and continuous wave Doppler. The device achieves a second harmonic distortion of -68dBc at  $V_{OUT} = 1V_{P-P}$  and  $f_{IN} = 5MHz$ , and an ultrasound-specific\* two-tone third-order intermodulation distortion performance of -55dBc at  $V_{OUT} = 1V_{P-P}$  and  $f_{IN} = 5MHz$ .

The MAX2034 is also optimized for quick overload recovery for operation under the large input signal conditions typically found in ultrasound input-buffer imaging applications.

The MAX2034 is available in a 48-pin thin QFN package with an exposed paddle. Electrical performance is guaranteed over a 0°C to +70°C temperature range.

## Ordering Information

PART	TEMP RANGE	PIN-PACKAGE	PKG CODE
MAX2034CTM+	0°C to +70°C	48 Thin QFN-EP** (7mm x 7mm)	T4877-4
MAX2034CTM	0°C to +70°C	48 Thin QFN-EP** (7mm x 7mm)	T4877-4
MAX2034CTM+T	0°C to +70°C	48 Thin QFN-EP** (7mm x 7mm)	T4877-4
MAX2034CTM-T	0°C to +70°C	48 Thin QFN-EP** (7mm x 7mm)	T4877-4

\*\*EP = Exposed paddle.

+Denotes lead-free package.

T = Tape-and-reel package.

\*See the Ultrasound-Specific IMD3 Specification in the Applications Information section.



## Features

- ◆ High-Level Integration of 4 Channels
- ◆ Digitally Programmable Input Impedance ( $R_{IN}$ ) of 50Ω, 100Ω, 200Ω, and 1kΩ
- ◆ Integrated Input Clamp
- ◆ Integrated Input-Damping Capacitor
- ◆ Ultra-Low 2.2dB Noise Figure at  $R_S = R_{IN} = 200Ω$
- ◆ 70MHz, -3dB Bandwidth
- ◆ Low 58mW/Channel Power Dissipation
- ◆ HD2 of -68dBc at  $V_{OUT} = 1V_{P-P}$  and  $f_{IN} = 5MHz$  for Exceptional Second Harmonic Imaging Performance
- ◆ Two-Tone Ultrasound-Specific\* IMD3 of -55dBc at  $V_{OUT} = 1V_{P-P}$  and  $f_{IN} = 5MHz$  for Exceptional PW/CW Doppler Performance
- ◆ Quick Large-Signal Overload Recovery
- ◆ Single +5V Supply Operation
- ◆ Sleep Mode

## Applications

Ultrasound Imaging  
Sonar Signal Amplification

## Pin Configuration

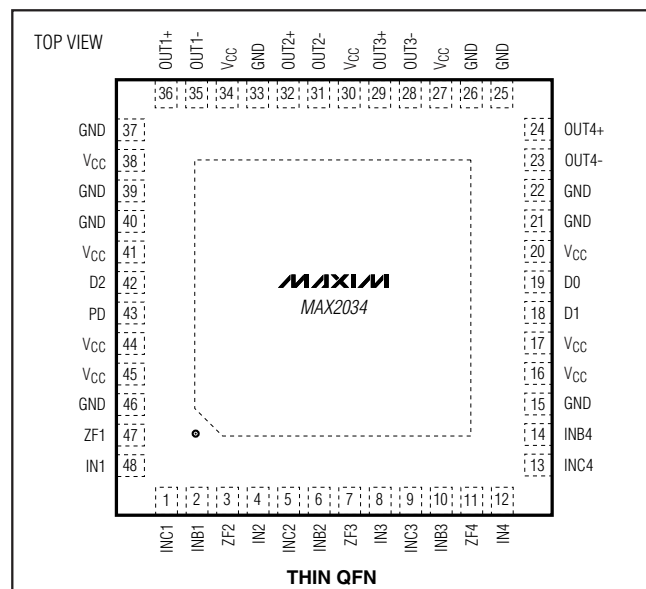

Typical Application Circuit appears at end of data sheet.

# Quad-Channel, Ultra-Low-Noise Amplifier with Digitally Programmable Input Impedance

## ABSOLUTE MAXIMUM RATINGS

V <sub>CC</sub> to GND .....	-0.3V to +5.5V	Operating Temperature Range.....	0°C to +70°C
Any Other Pins to GND.....	-0.3V to (V <sub>CC</sub> + 0.3V)	Junction Temperature.....	+150°C
IN <sub>-</sub> to INB <sub>-</sub> .....	-2V to +2V	θ <sub>JC</sub> .....	0.8°C/W
INC <sub>-</sub> to GND .....	-24mA to +24mA	θ <sub>JA</sub> .....	25°C/W
Continuous Power Dissipation (T <sub>A</sub> = +70°C)		Storage Temperature Range .....	-40°C to +150°C
48-Pin TQFN (derated 40mW/°C above +70°C) .....	3200mW	Lead Temperature (soldering, 10s).....	+300°C

Stresses beyond those listed under "Absolute Maximum Ratings" may cause permanent damage to the device. These are stress ratings only, and functional operation of the device at these or any other conditions beyond those indicated in the operational sections of the specifications is not implied. Exposure to absolute maximum rating conditions for extended periods may affect device reliability.

## DC ELECTRICAL CHARACTERISTICS

(MAX2034 Typical Application Circuit, V<sub>CC</sub> = +4.75V to +5.25V, no input signal applied between IN1–IN4 and GND, T<sub>A</sub> = 0°C to +70°C. Typical values are at V<sub>CC</sub> = +5.0V and T<sub>A</sub> = +25°C, unless otherwise noted.) (Note 1)

PARAMETER	SYMBOL	CONDITIONS	MIN	TYP	MAX	UNITS
Supply Voltage	V <sub>CC</sub>		4.75	5.0	5.25	V
Total Supply Current	I <sub>CC</sub>	Normal mode (PD = 0), no signals applied, see the <i>Typical Operating Characteristics</i> for I <sub>CC</sub> as a function of input signal		46.5	54.5	mA
	I <sub>CC,PD</sub>	Sleep mode (PD = 1), V <sub>IN-</sub> = 112mV <sub>P-P</sub> at 5MHz		0.8	4	
<b>LOGIC INPUTS (PD, D2, D1, D0)</b>						
Input High Voltage	V <sub>IH</sub>		4.0			V
Input Low Voltage	V <sub>IL</sub>				1.0	V
Input Current with Logic-High	I <sub>IH</sub>				1	μA
Input Current with Logic-Low	I <sub>IL</sub>				1	μA

## AC ELECTRICAL CHARACTERISTICS

(MAX2034 Typical Application Circuit, V<sub>CC</sub> = +4.75V to +5.25V, source impedance R<sub>S</sub> = 200Ω, PD = 0, D2/D1/D0 = 0/1/0 (R<sub>IN</sub> = 200Ω), signal AC-coupled to IN<sub>-</sub>, INB<sub>-</sub> is AC grounded, V<sub>OUT</sub> is the differential output between OUT<sub>+</sub> and OUT<sub>-</sub>, f<sub>IN-</sub> = 5MHz, R<sub>L</sub> = 200Ω between the differential outputs, C<sub>L</sub> = 20pF from each output to ground, T<sub>A</sub> = 0°C to +70°C. Typical values are at V<sub>CC</sub> = 5.0V and T<sub>A</sub> = +25°C, unless otherwise noted.) (Note 1)

PARAMETER	SYMBOL	CONDITIONS	MIN	TYP	MAX	UNITS
Input Resistance	R <sub>IN</sub>	D2/D1/D0 = 0/0/0		53		Ω
		D2/D1/D0 = 0/0/1		105		
		D2/D1/D0 = 0/1/0		206		
		D2/D1/D0 = 0/1/1		870		
Typical Input Resistance Variation from Nominal Programmed				±1		%
Input Capacitance	C <sub>IN</sub>			40		pF
Gain	A <sub>V</sub>	(OUT <sub>+</sub> - OUT <sub>-</sub> ) / IN <sub>-</sub>		19		dB
Part-to-Part Gain Variation from Nominal		T <sub>A</sub> = +25°C, R <sub>L</sub> = 200Ω ±10%	0	±0.1	±0.5	dB
-3dB Small-Signal Gain Bandwidth	f <sub>-3dB</sub>	D2/D1/D0 = 0/0/0, (50Ω input impedance), V <sub>OUT</sub> = 0.2V <sub>P-P</sub>		70		MHz
Slew Rate				280		V/μs

# Quad-Channel, Ultra-Low-Noise Amplifier with Digitally Programmable Input Impedance

MAX2034

## AC ELECTRICAL CHARACTERISTICS (continued)

(MAX2034 Typical Application Circuit,  $V_{CC} = +4.75V$  to  $+5.25V$ , source impedance  $R_S = 200\Omega$ ,  $P_D = 0$ ,  $D2/D1/D0 = 0/1/0$  ( $R_{IN} = 200\Omega$ ), signal AC-coupled to  $IN_-$ ,  $INB_-$  is AC grounded,  $V_{OUT}$  is the differential output between  $OUT_+$  and  $OUT_-$ ,  $f_{IN_-} = 5MHz$ ,  $R_L = 200\Omega$  between the differential outputs,  $C_L = 20pF$  from each output to ground,  $T_A = 0^\circ C$  to  $+70^\circ C$ . Typical values are at  $V_{CC} = 5.0V$  and  $T_A = +25^\circ C$ , unless otherwise noted.) (Note 1)

PARAMETER	SYMBOL	CONDITIONS	MIN	TYP	MAX	UNITS
Noise Figure	NF	$R_S = R_{IN} = 50\Omega$		4.1		dB
		$R_S = R_{IN} = 100\Omega$		2.9		
		$R_S = R_{IN} = 200\Omega$		2.2		
		$R_S = R_{IN} = 1000\Omega$		1.4		
Input-Referred Noise Voltage		$D2 = 1$ (high input impedance), $f_{IN_-} = 5MHz$		0.87		$nV/\sqrt{Hz}$
Input-Referred Noise Current		$D2 = 1$ (high input impedance), $f_{IN_-} = 5MHz$		2.1		$pA/\sqrt{Hz}$
Second Harmonic	HD2	$f_{IN_-} = 5MHz$ , $V_{OUT} = 1V_{P-P}$ differential	-50	-68		dBc
		$f_{IN_-} = 10MHz$ , $V_{OUT} = 1V_{P-P}$ differential		-66		
Third Harmonic	HD3	$f_{IN_-} = 5MHz$ , $V_{OUT} = 1V_{P-P}$ differential		-50		dBc
		$f_{IN_-} = 10MHz$ , $V_{OUT} = 1V_{P-P}$ differential		-44		
Two-Tone Intermodulation Distortion (Note 2)	IMD3	4.99MHz tone relative to the second tone at 5.01MHz, which is 25dB lower than the first tone at 5.00MHz, $V_{OUT} = 1V_{P-P}$ differential	-45	-55		dBc
		7.49MHz tone relative to the second tone at 7.51MHz, which is 25dB lower than the first tone at 7.50MHz, $V_{OUT} = 1V_{P-P}$ differential		-52		
Maximum Output Signal Amplitude		Differential output		4.4		$V_{P-P}$
Gain Compression		Gain at $V_{IN_-} = 112mV_{P-P}$ relative to gain at $V_{IN_-} = 550mV_{P-P}$		0.5	3	dB
Output Common-Mode Level				2.45		V
Output Impedance		Single-ended		5.3		$\Omega$
Phase Matching Between Channels		Phase difference between channels with $V_{IN_-} = 195mV$ peak (-3dB full scale), $f_{IN_-} = 10MHz$		$\pm 1.5$		deg
Channel-to-Channel Crosstalk		$f_{IN_-} = 10MHz$ , $V_{OUT} = 1V_{P-P}$ , adjacent channels	50	66		dB
Switch Time from Normal to Sleep Mode		Supply current settles to 90% of nominal sleep-mode current $I_{CC,PD}$		0.3		ms
Switch Time from Sleep to Normal Mode		$V_{OUT}$ settles to 90% of final $1V_{P-P}$ output		0.3		ms

**Note 1:** Min and max limits at  $T_A = +25^\circ C$  and  $+70^\circ C$  are guaranteed by design, characterization, and/or production test.

**Note 2:** See the *Ultrasound-Specific IMD3 Specification* in the *Applications Information* section.

# Quad-Channel, Ultra-Low-Noise Amplifier with Digitally Programmable Input Impedance

## Typical Operating Characteristics

(MAX2034 Typical Application Circuit,  $V_{CC} = +4.75V$  to  $+5.25V$ , source impedance  $R_S = 200\Omega$ ,  $PD = 0$ ,  $D2/D1/D0 = 0/1/0$  ( $R_{IN} = 200\Omega$ ), signal AC-coupled to  $IN_-$ ,  $INB_+$  is AC grounded,  $V_{OUT}$  is the differential output between  $OUT_+$  and  $OUT_-$ ,  $f_{IN} = 5MHz$ ,  $R_L = 200\Omega$  between the differential outputs,  $C_L = 20pF$  from each output to ground,  $T_A = 0^\circ C$  to  $+70^\circ C$ , unless otherwise specified.)

**SMALL-SIGNAL BANDWIDTH vs. FREQUENCY**

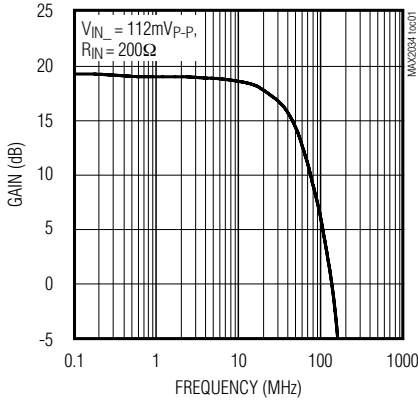

**SMALL-SIGNAL BANDWIDTH vs. FREQUENCY**

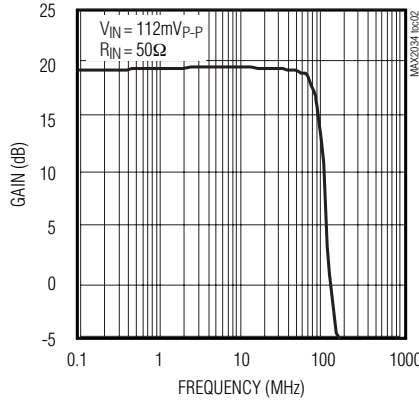

**LARGE-SIGNAL BANDWIDTH vs. FREQUENCY**

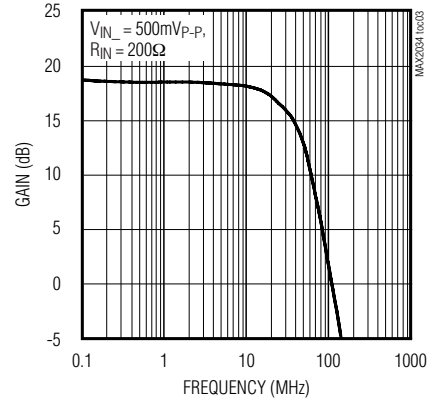

**LARGE-SIGNAL BANDWIDTH vs. FREQUENCY**

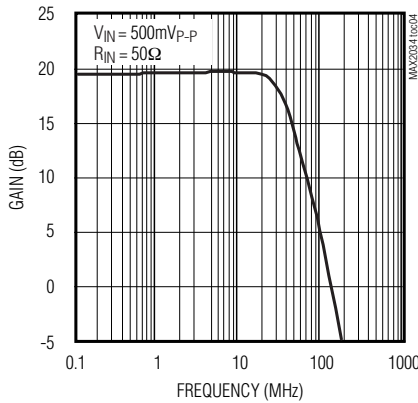

**COMPLEX INPUT IMPEDANCE MAGNITUDE vs. FREQUENCY**

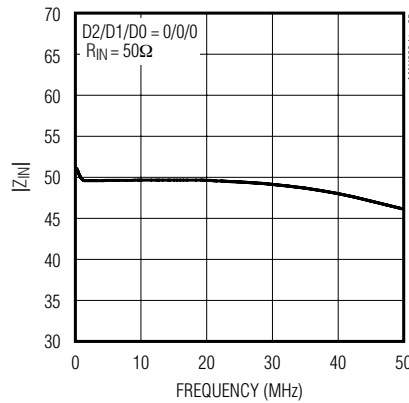

**COMPLEX INPUT IMPEDANCE MAGNITUDE vs. FREQUENCY**

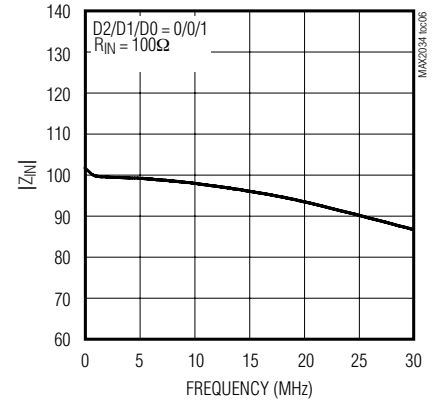

**COMPLEX INPUT IMPEDANCE MAGNITUDE vs. FREQUENCY**

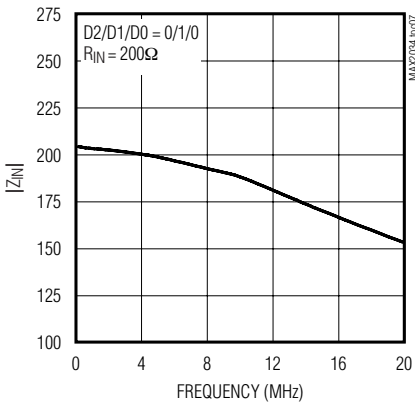

**COMPLEX INPUT IMPEDANCE MAGNITUDE vs. FREQUENCY**

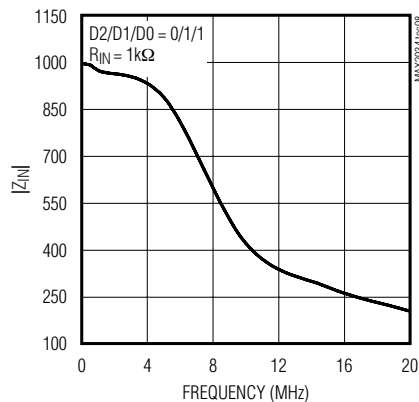

**HARMONIC DISTORTION vs. FREQUENCY**

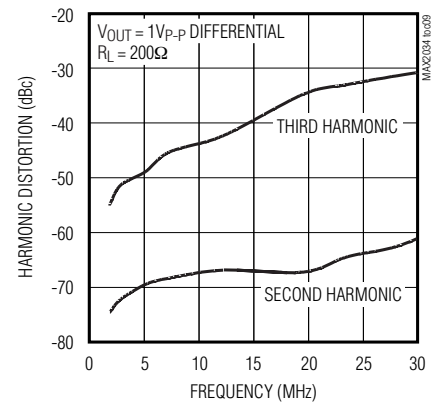

# Quad-Channel, Ultra-Low-Noise Amplifier with Digitally Programmable Input Impedance

## Typical Operating Characteristics (continued)

(MAX2034 Typical Application Circuit,  $V_{CC} = +4.75V$  to  $+5.25V$ , source impedance  $R_S = 200\Omega$ ,  $PD = 0$ ,  $D2/D1/D0 = 0/1/0$  ( $R_{IN} = 200\Omega$ ), signal AC-coupled to  $IN_-$ ,  $INB_+$  is AC grounded,  $V_{OUT}$  is the differential output between  $OUT_+$  and  $OUT_-$ ,  $f_{IN} = 5MHz$ ,  $R_L = 200\Omega$  between the differential outputs,  $C_L = 20pF$  from each output to ground,  $T_A = 0^\circ C$  to  $+70^\circ C$ , unless otherwise specified.)

**TWO-TONE ULTRASOUND-SPECIFIC IMD3 vs. FREQUENCY**

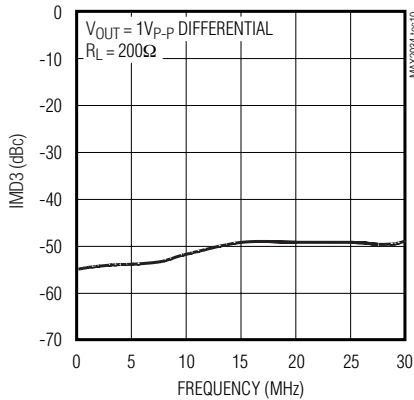

**LARGE-SIGNAL NOISE FIGURE vs. OFFSET FREQUENCY**

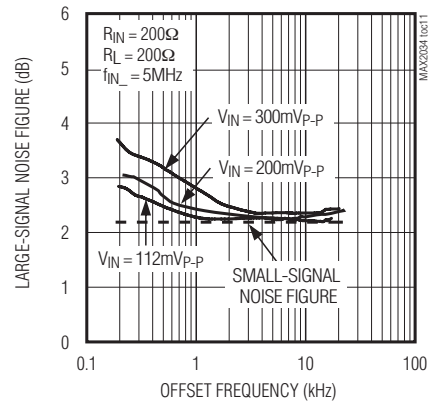

**GAIN-ERROR HISTOGRAM**

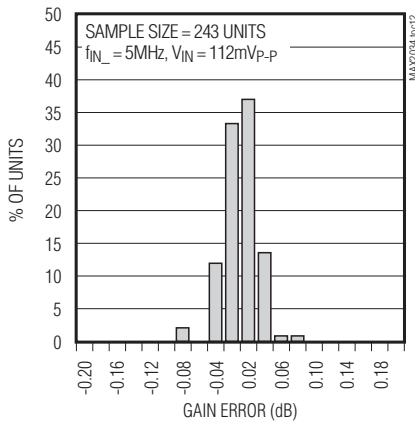

**CHANNEL-TO-CHANNEL CROSSTALK vs. FREQUENCY**

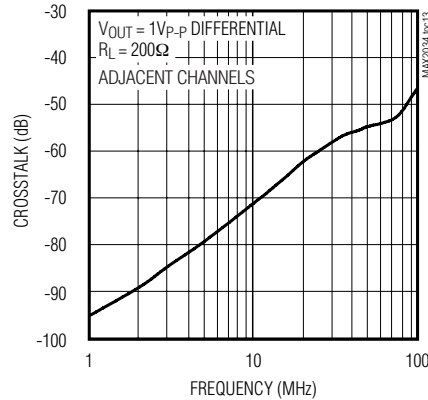

**SUPPLY CURRENT vs. DIFFERENTIAL OUTPUT VOLTAGE**

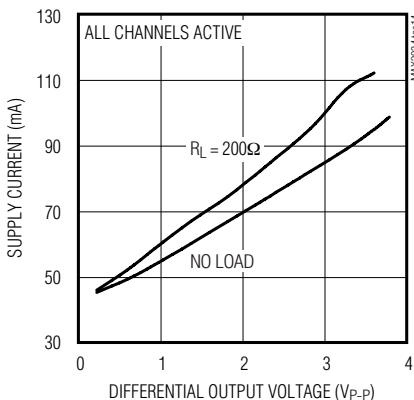

**LARGE-SIGNAL RECOVERY**

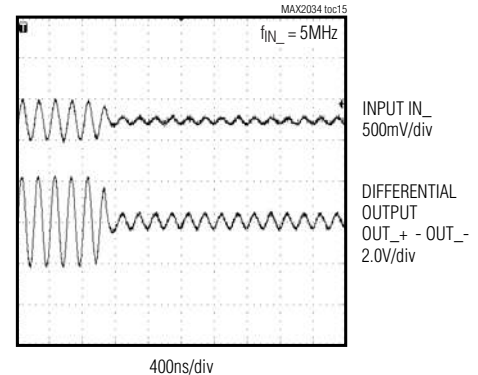

# Quad-Channel, Ultra-Low-Noise Amplifier with Digitally Programmable Input Impedance

## Typical Operating Characteristics (continued)

(MAX2034 Typical Application Circuit,  $V_{CC} = +4.75V$  to  $+5.25V$ , source impedance  $R_S = 200\Omega$ ,  $PD = 0$ ,  $D2/D1/D0 = 0/1/0$  ( $R_{IN} = 200\Omega$ ), signal AC-coupled to  $IN_{-}$ ,  $INB_{-}$  is AC grounded,  $V_{OUT}$  is the differential output between  $OUT_{+}$  and  $OUT_{-}$ ,  $f_{IN} = 5MHz$ ,  $R_L = 200\Omega$  between the differential outputs,  $C_L = 20pF$  from each output to ground,  $T_A = 0^{\circ}C$  to  $+70^{\circ}C$ , unless otherwise specified.)

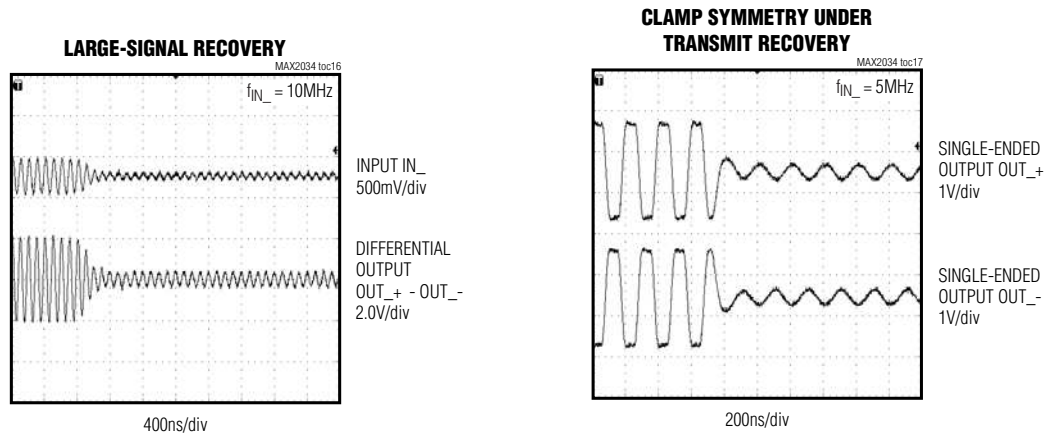

## Pin Description

PIN	NAME	FUNCTION
1	INC1	Channel 1 Analog Input Clamp. Input port to the integrated clamping diodes.
2	INB1	Channel 1 Analog Bypass Input. Connect a capacitor to GND as close as possible to the pin.
3	ZF2	Channel 2 Active Impedance-Matching Port. AC-couple to the source circuit with a capacitor.
4	IN2	Channel 2 LNA Analog Input. Single-ended input for channel 2 amplifier. Connect the analog input to the source circuit through a series capacitor.
5	INC2	Channel 2 Analog Input Clamp. Input port to the integrated clamping diodes.
6	INB2	Channel 2 Analog Bypass Input. Connect a capacitor to GND as close as possible to the pin.
7	ZF3	Channel 3 Active Impedance-Matching Port. AC-couple to the source circuit with a capacitor.
8	IN3	Channel 3 LNA Analog Input. Single-ended input for channel 3 amplifier. Connect the analog input to the source circuit through a series capacitor.
9	INC3	Channel 3 Analog Input Clamp. Input port to the integrated clamping diodes.
10	INB3	Channel 3 Analog Bypass Input. Connect a capacitor to GND as close as possible to the pin.
11	ZF4	Channel 4 Active Impedance-Matching Port. AC-couple to the source circuit with a capacitor.
12	IN4	Channel 4 LNA Analog Input. Single-ended input for channel 4 amplifier. Connect the analog input to the source circuit through a series capacitor.
13	INC4	Channel 4 Analog Input Clamp. Input port to the integrated clamping diodes.
14	INB4	Channel 4 Analog Bypass Input. Connect a capacitor to GND as close as possible to the pin.
15, 21, 22, 25, 26, 33, 37, 39, 40, 46	GND	Ground
16, 17, 20, 27, 30, 34, 38, 41, 44, 45	$V_{CC}$	5V Power Supply. Supply for the four LNAs. Bypass each $V_{CC}$ supply with a 100nF capacitor as close as possible to the pin.

# Quad-Channel, Ultra-Low-Noise Amplifier with Digitally Programmable Input Impedance

MAX2034

## Pin Description (continued)

PIN	NAME	FUNCTION
18, 19, 42	D1, D0, D2	Digitally Programmable Inputs. Programs the input impedance of each amplifier. See Table 1 on input impedance programming information.
23	OUT4-	Channel 4 LNA Analog Inverting Output
24	OUT4+	Channel 4 LNA Analog Noninverting Output
28	OUT3-	Channel 3 LNA Analog Inverting Output
29	OUT3+	Channel 3 LNA Analog Noninverting Output
31	OUT2-	Channel 2 LNA Analog Inverting Output
32	OUT2+	Channel 2 LNA Analog Noninverting Output
35	OUT1-	Channel 1 LNA Analog Inverting Output
36	OUT1+	Channel 1 LNA Analog Noninverting Output
43	PD	Power-Down. Drive PD high to put the device in sleep mode. Drive PD low for normal mode.
47	ZF1	Channel 1 Active Impedance-Matching Port. AC-couple to the source circuit with a capacitor.
48	IN1	Channel 1 LNA Analog Input. Single-ended input for channel 1 amplifier. Connect the analog input to the source circuit through a series capacitor.
EP	GND	Exposed Paddle. Solder the exposed paddle to the ground plane using multiple vias.

### Detailed Description

The MAX2034 is a four-channel, ultra-low-noise preamplifier. Each amplifier features single-ended inputs, differential outputs, and provides an accurate fixed gain of 19dB with a wide -3dB bandwidth of 70MHz. The high-gain accuracy of the amplifier allows for exceptional channel-to-channel gain matching, which is necessary for high-performance ultrasound-imaging applications. The device has an exceptionally low noise figure, making it ideal for use in ultrasound front-end designs. Noise figure is typically 2.2dB for a source impedance and programmed input impedance of 200Ω.

The MAX2034 is optimized for excellent dynamic range and linearity performance characteristics, making it ideal for ultrasound-imaging modalities including second harmonic 2D imaging and continuous wave Doppler. The device achieves an HD2 of -68dBc at  $V_{OUT} = 1V_{P-P}$  and  $f_{IN} = 5MHz$ , and an ultrasound-specific two-tone IMD3 performance of -55dBc at  $V_{OUT} = 1V_{P-P}$  and  $f_{IN} = 5MHz$ . See the *Ultrasound-Specific IMD3 Specification* in the *Applications Information* section.

### Active Impedance Matching

To provide exceptional noise-figure characteristics, the input impedance of each amplifier uses a feedback topology for active impedance matching. A feedback resistor of the value  $(1 + (A / 2)) \times R_S$  is added between the inverting output of the amplifier to the input. The input impedance is the feedback resistor,  $Z_F$ , divided by  $1 + (A / 2)$ . The factor of two is due to the gain of the

amplifier,  $A$ , being defined with a differential output. For common input impedances, the internal digitally programmed impedances can be used (see Table 1). For other input impedances, program the impedance for external resistor operation, and then use an externally supplied resistor to set the input impedance according to the above formula.

The gain and input impedance of the MAX2034 vs. frequency are shown in the *Typical Operating Characteristics*. Both gain and input impedance are well behaved, with no peaking characteristics. This allows the device to be used with a variety of input networks, with no requirement for series ferrite beads or shunt capacitors for stability control.

**Table 1. Digitally Programmable Input Impedance**

D2	D1	D0	$R_{IN} (\Omega)$
0	0	0	50
0	0	1	100
0	1	0	200
0	1	1	1k
1	0	0	Defined by external resistor
1	0	1	
1	1	0	
1	1	1	



# Quad-Channel, Ultra-Low-Noise Amplifier with Digitally Programmable Input Impedance

## Functional Diagram

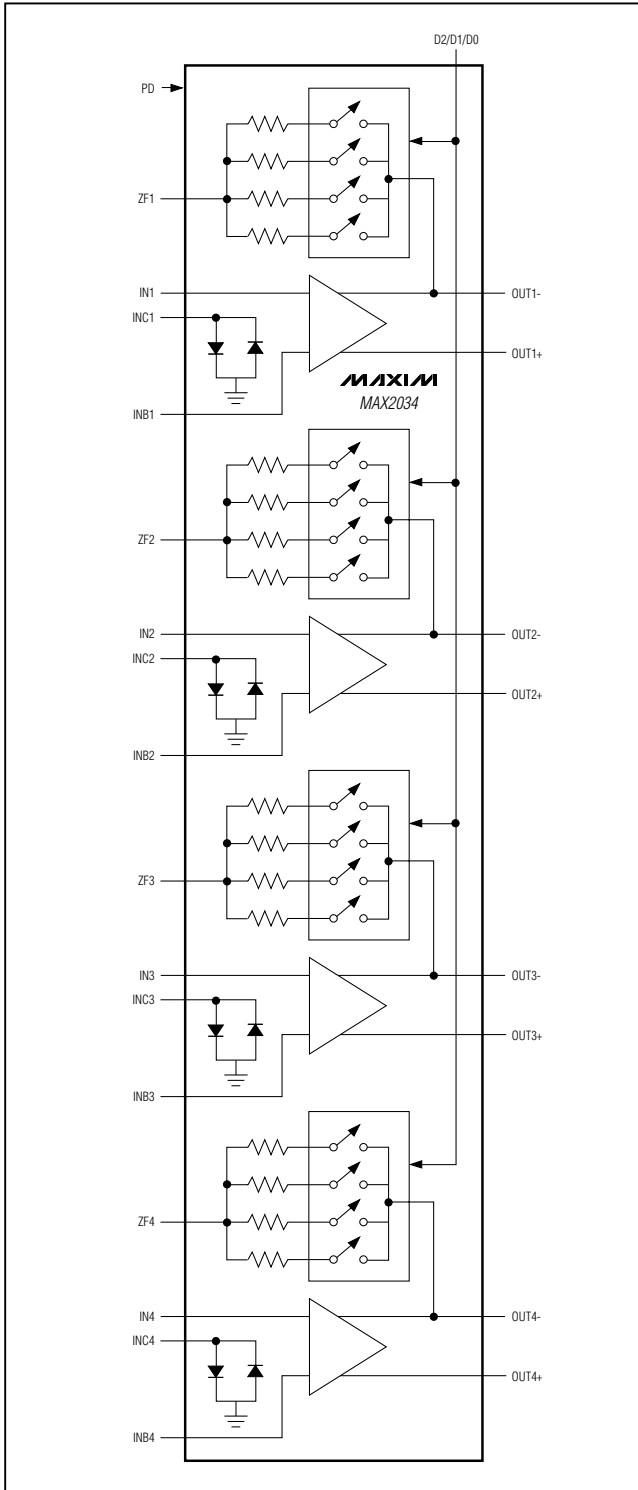

### Digitally Programmable Input Impedance

The MAX2034 features an on-chip digitally programmable input impedance, which makes the part compatible with a variety of source impedances ranging from 50Ω to 1kΩ. The input impedance can be programmed for 50Ω, 100Ω, 200Ω, or 1kΩ through the digital inputs D2, D1, and D0. See Table 1 for programming details. In addition to these fixed values, virtually any other input impedance can be supported by using an off-chip external feedback resistor, R<sub>F</sub>. To utilize this feature, set D2, D1, and D0 to any of the four external resistor-controlled states shown in Table 1. The value of the off-chip feedback resistor can be determined by using the following relationship:

$$R_F = (1 + (A / 2)) \times R_S$$

where R<sub>S</sub> is the source impedance, and A is the gain of the amplifier (A = 9) defined with a differential output.

### Noise Figure

The MAX2034 is designed to provide maximum input sensitivity with its exceptionally low noise figure. The input active devices are selected for very low equivalent input noise voltage and current, and they have been optimized for source impedances from 50Ω to 1000Ω. Additionally, the noise contribution of the matching resistor is effectively divided by 1 + (A / 2). Using this scheme, typical noise figure of the amplifier is approximately 2.2dB for R<sub>IN</sub> = R<sub>S</sub> = 200Ω. Table 2 illustrates the noise figure for other input impedances.

**Table 2. Noise Figure vs. Source and Input Impedances**

R <sub>S</sub> (Ω)	R <sub>IN</sub> (Ω)	NF (dB)
50	50	4.1
100	100	2.9
200	200	2.2
1000	1000	1.4

### Input Clamp

The MAX2034 includes configurable integrated input-clamping diodes. The diodes are clamped to ground at ±275mV. The input-clamping diodes can be used to prevent large transmit signals from overdriving the inputs of the amplifiers. Overdriving the inputs could possibly place charge on the input-coupling capacitor, causing longer transmit overload recovery times. Input signals are AC-coupled to the single-ended inputs IN1–IN4, but are clamped with the INC1–INC4 inputs. See the *Typical Application Circuit*. If external clamping devices are preferred, simply leave INC1–INC4 unconnected.

# Quad-Channel, Ultra-Low-Noise Amplifier with Digitally Programmable Input Impedance

## Integrated Input Damping Capacitor

At high frequencies, gain peaking can occur due to an active input termination becoming less effective when the gain rolls off. Although an external shunting capacitor can be used to mitigate this effect, different input impedance modes require different capacitor values. The MAX2034 integrates a damping capacitor for each of the four programmed input impedance modes. When the input impedance is programmed by applying the appropriate D2/D1/D0, an optimal capacitor value is also chosen for the particular input impedance mode, eliminating the need for external capacitors.

## Overload Recovery

The device is also optimized for quick overload recovery for operation under the large input signal conditions that are typically found in ultrasound input-buffer imaging applications. Internal signal clipping is symmetrical. Input overloads can be prevented with the input-clamping diodes. See the *Typical Operating Characteristics* that illustrate the rapid recovery time from a transmit-related overload.

## Sleep Mode

The sleep mode function allows the MAX2034 to be configured in a low-power state when the amplifiers are not being used. In sleep mode, all amplifiers are powered down, the total supply current of the device reduces to 0.8mA, and the input impedance of each amplifier is set at high impedance. Drive the PD input high to activate sleep mode. For normal operation, drive the PD input low.

## Applications Information

### Analog Input Coupling

AC-couple to ground the analog bypass input by connecting a 0.1 $\mu$ F capacitor at the INB1–INB4 input to GND (0.1 $\mu$ F recommended). Since the amplifiers are designed with a differential input stage, bypassing the INB1–INB4 inputs configures the MAX2034 for single-ended inputs at IN1–IN4.

Connect the IN1–IN4 inputs to their source circuits through 0.1 $\mu$ F series capacitors. Connect the feedback ports ZF1–ZF4 to the source circuits through 0.018 $\mu$ F capacitors. (These capacitors will be 1/(5.5) as large as the input-coupling capacitors. This equalizes the high-pass filter characteristic of both the input and feedback input ports, due to the feedback resistance related by a factor of 1/(5.5) to the input impedance.)

Note that the active input circuitry of the MAX2034 is stable, and does not require external ferrite beads or shunt capacitors to achieve high-frequency stability.

The *Typical Application Circuit* illustrates these coupling capacitors. If a ground-referenced current-limiting stage precedes the MAX2034 inputs, its output can be connected to the integrated clamping diodes on pins INC1–INC4 to facilitate very rapid recovery from transient overloads associated with transmitter operation in ultrasound applications.

### Analog Output Coupling

The differential outputs of the MAX2034 are capable of driving a differential load impedance of 200 $\Omega$  or greater. The differential output has a common-mode bias of approximately 2.45V. AC-couple these differential outputs if the next stage has a different common-mode input range.

### Board Layout

The pin configuration of the MAX2034 is optimized to facilitate a very compact physical layout of the device and its associated discrete components. A typical application for this device might incorporate several devices in close proximity to handle multiple channels of signal processing.

The exposed paddle (EP) of the MAX2034's thin QFN-EP package provides a low thermal-resistance path to the die. It is important that the PC board on which the MAX2034 is mounted be designed to conduct heat from the EP. In addition, provide the EP with a low-inductance path to electrical ground. The EP **MUST** be soldered to a ground plane on the PC board, either directly or through an array of plated via holes.

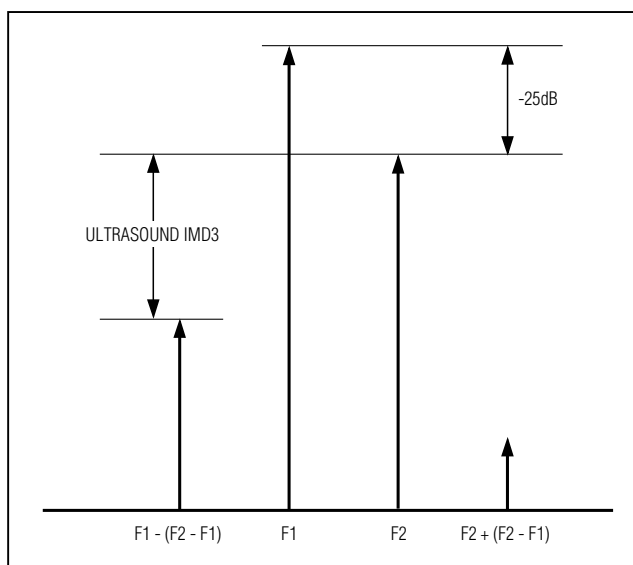

Figure 1. Ultrasound IMD3 Measurement Technique

# Quad-Channel, Ultra-Low-Noise Amplifier with Digitally Programmable Input Impedance

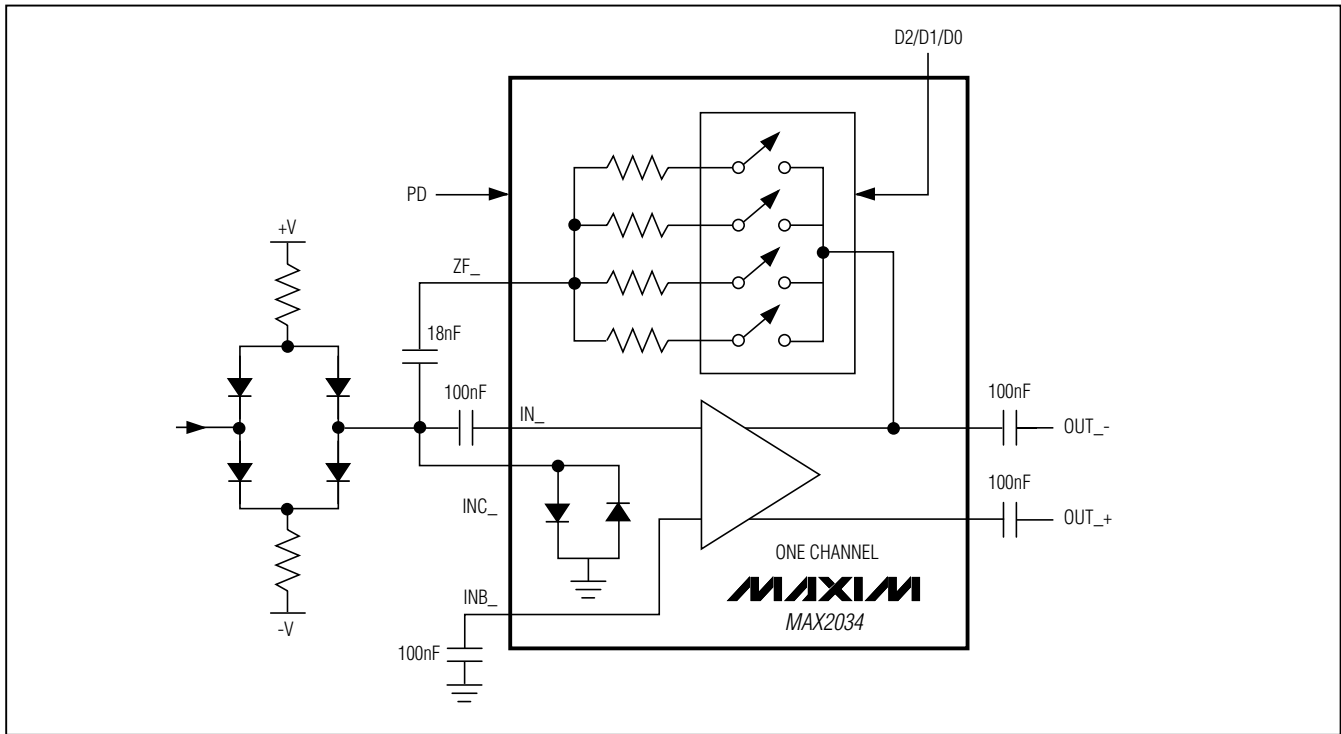

Figure 2. Typical Single-Channel Ultrasound Application Circuit

### Ultrasound-Specific IMD3 Specification

Unlike typical communications specs, the two input tones are not equal in magnitude for the ultrasound-specific IMD3 two-tone specification. In this measurement, F1 represents reflections from tissue and F2 represents reflections from blood. The latter reflections are typically 25dB lower in magnitude, and hence the measurement is defined with one input tone 25dB lower than the other. The IMD3 product of interest (F1 - (F2 - F1)) presents itself as an undesired Doppler error signal in ultrasound applications. See Figure 1.

# Quad-Channel, Ultra-Low-Noise Amplifier with Digitally Programmable Input Impedance

## Typical 200Ω Application Circuit

MAX2034

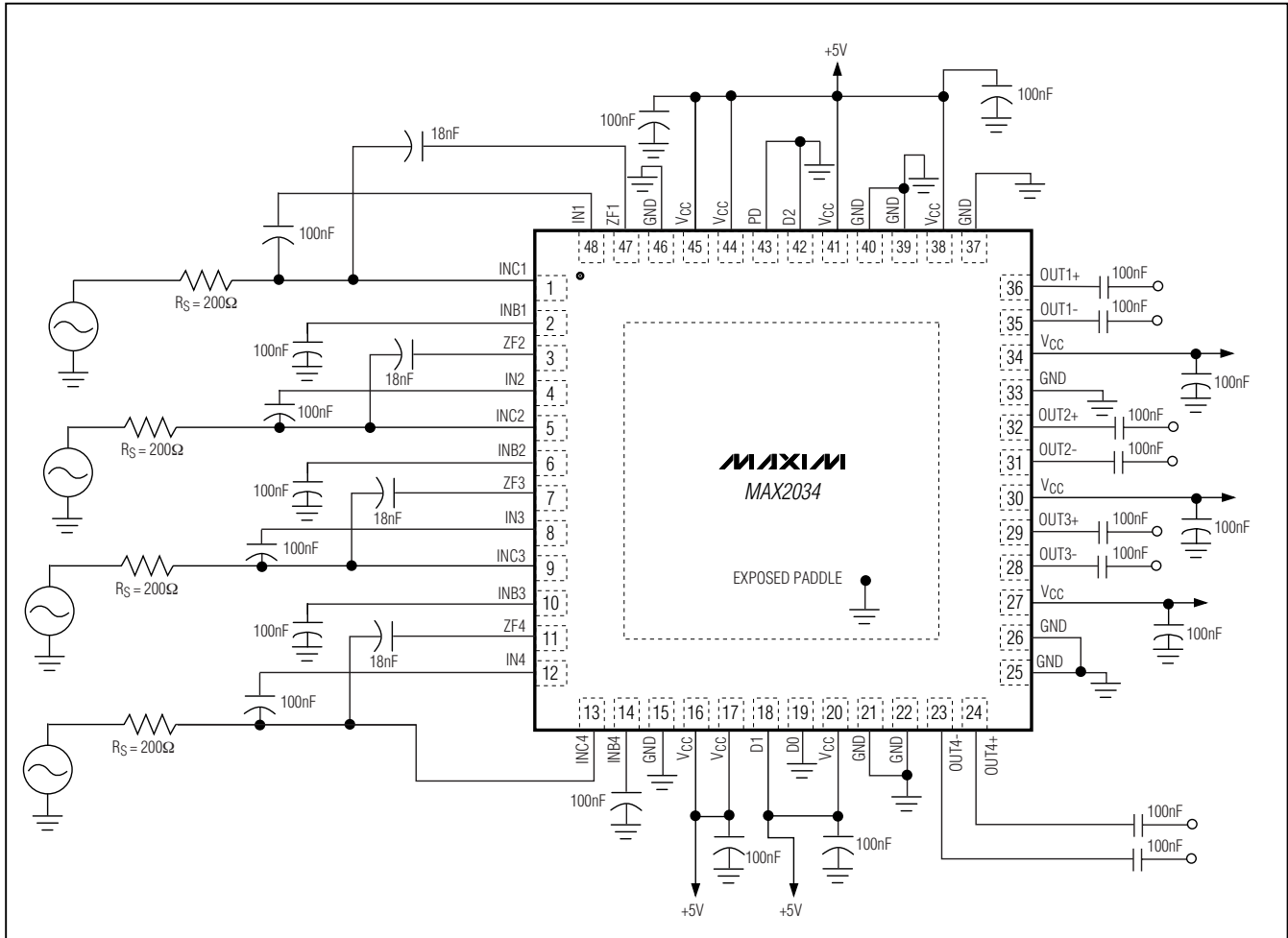



# Quad-Channel, Ultra-Low-Noise Amplifier with Digitally Programmable Input Impedance

## Package Information

(The package drawing(s) in this data sheet may not reflect the most current specifications. For the latest package outline information, go to [www.maxim-ic.com/packages](http://www.maxim-ic.com/packages).)

MAX2034

COMMON DIMENSIONS														EXPOSED PAD VARIATIONS													
PKG	32L 7x7			44L 7x7			48L 7x7			CUSTOM PKG. (T4877-1) 48L 7x7			56L 7x7			PKG. CODES	DEPOPULATED LEADS	D2			E2			JEDEC MO220 REV. C	DOWN BONDS ALLOWED		
	SYMBOL	MIN.	NOM.	MAX.	MIN.	NOM.	MAX.	MIN.	NOM.	MAX.	MIN.	NOM.	MAX.	MIN.	NOM.			MAX.	MIN.	NOM.	MAX.	MIN.	NOM.			MAX.	
A	0.70	0.75	0.80	0.70	0.75	0.80	0.70	0.75	0.80	0.70	0.75	0.80	0.70	0.75	0.80	T3277-2	-	4.85	4.70	4.85	4.65	4.70	4.85	-	YES		
A1	0	0.02	0.05	0	0.02	0.05	0	0.02	0.05	0	0.02	0.05	0	-	0.05	T3277-3	-	4.65	4.70	4.85	4.65	4.70	4.85	-	NO		
A2	0.20 REF.			0.20 REF.			0.20 REF.			0.20 REF.			0.20 REF.			T4477-2	-	4.55	4.70	4.85	4.55	4.70	4.85	WKD-1	YES		
b	0.25	0.30	0.35	0.20	0.25	0.30	0.20	0.25	0.30	0.20	0.25	0.30	0.15	0.20	0.25	T4477-3	-	4.85	4.70	4.85	4.65	4.70	4.85	WKD-1	YES		
D	6.90	7.00	7.10	6.90	7.00	7.10	6.90	7.00	7.10	6.90	7.00	7.10	6.90	7.00	7.10	T4877-1**	13,24,37,48	4.20	4.30	4.40	4.20	4.30	4.40	-	NO		
E	6.90	7.00	7.10	6.90	7.00	7.10	6.90	7.00	7.10	6.90	7.00	7.10	6.90	7.00	7.10	T4877-3	-	4.95	5.10	5.25	4.95	5.10	5.25	-	YES		
e	0.65 BSC.			0.50 BSC.			0.60 BSC.			0.50 BSC.			0.40 BSC.			T4877-4	-	5.45	5.80	5.63	5.45	5.60	5.63	-	YES		
k	0.25	-	-	0.25	-	-	0.25	-	-	0.25	-	-	0.25	0.35	0.45	T4877-5	-	2.40	2.50	2.60	2.40	2.50	2.60	-	NO		
L	0.45	0.65	0.65	0.45	0.65	0.65	0.30	0.40	0.50	0.45	0.55	0.65	0.40	0.60	0.60	T4877-6	-	5.45	5.60	5.63	5.45	5.60	5.63	-	NO		
L1	-	-	-	-	-	-	-	-	-	-	-	-	0.30	0.40	0.50	T4877-7	-	4.95	5.10	5.25	4.95	5.10	5.25	-	YES		
N	32			44			48			44			56			T5677-1	-	5.20	5.30	5.40	5.20	5.30	5.40	-	YES		
ND	8			11			12			10			14														
NE	8			11			12			12			14														

\*\* NOTE: T4877-1 IS A CUSTOM 48L PKG. WITH 4 LEADS DEPOPULATED. TOTAL NUMBER OF LEADS ARE 44.

NOTES:

- DIMENSIONING & TOLERANCING CONFORM TO ASME Y14.5M-1994.
- ALL DIMENSIONS ARE IN MILLIMETERS. ANGLES ARE IN DEGREES.
- N IS THE TOTAL NUMBER OF TERMINALS.
- THE TERMINAL #1 IDENTIFIER AND TERMINAL NUMBERING CONVENTION SHALL CONFORM TO JESD 95-1 SPP-012. DETAILS OF TERMINAL #1 IDENTIFIER ARE OPTIONAL, BUT MUST BE LOCATED WITHIN THE ZONE INDICATED. THE TERMINAL #1 IDENTIFIER MAY BE EITHER A MOLD OR MARKED FEATURE.
- DIMENSION b APPLIES TO METALLIZED TERMINAL AND IS MEASURED BETWEEN 0.25 mm AND 0.30 mm FROM TERMINAL TIP.
- ND AND NE REFER TO THE NUMBER OF TERMINALS ON EACH D AND E SIDE RESPECTIVELY.
- DEPOPULATION IS POSSIBLE IN A SYMMETRICAL FASHION.
- COPLANARITY APPLIES TO THE EXPOSED HEAT SINK SLUG AS WELL AS THE TERMINALS.
- DRAWING CONFORMS TO JEDEC MO220 EXCEPT THE EXPOSED PAD DIMENSIONS OF T4877-1/-3/-4/-5/-6 & T5677-1.
- WARPAGE SHALL NOT EXCEED 0.10 mm.
- MARKING IS FOR PACKAGE ORIENTATION REFERENCE ONLY
- NUMBER OF LEADS SHOWN ARE FOR REFERENCE ONLY

**-DRAWING NOT TO SCALE-**

TITLE: PACKAGE OUTLINE 32, 44, 48, 56L THIN QFN, 7x7x0.8mm	
APPROVAL:	DOCUMENT CONTROL NO. 21-0144
REV. E	2/2

## Revision History

Pages changed at Rev 1: 1, 3, 4, 11, 12

Maxim cannot assume responsibility for use of any circuitry other than circuitry entirely embodied in a Maxim product. No circuit patent licenses are implied. Maxim reserves the right to change the circuitry and specifications without notice at any time.

Maxim Integrated Products, 120 San Gabriel Drive, Sunnyvale, CA 94086 408-737-7600 13