



Chipsmall Limited consists of a professional team with an average of over 10 year of expertise in the distribution of electronic components. Based in Hongkong, we have already established firm and mutual-benefit business relationships with customers from,Europe,America and south Asia,supplying obsolete and hard-to-find components to meet their specific needs.

With the principle of “Quality Parts,Customers Priority,Honest Operation,and Considerate Service”,our business mainly focus on the distribution of electronic components. Line cards we deal with include Microchip,ALPS,ROHM,Xilinx,Pulse,ON,Everlight and Freescale. Main products comprise IC,Modules,Potentiometer,IC Socket,Relay,Connector.Our parts cover such applications as commercial,industrial, and automotives areas.

We are looking forward to setting up business relationship with you and hope to provide you with the best service and solution. Let us make a better world for our industry!



Contact us

Tel: +86-755-8981 8866 Fax: +86-755-8427 6832

Email & Skype: info@chipsmall.com Web: www.chipsmall.com

Address: A1208, Overseas Decoration Building, #122 Zhenhua RD., Futian, Shenzhen, China



EVALUATION KIT
AVAILABLE

1700MHz to 3000MHz High-Linearity, Low LO Leakage Base-Station Rx/Tx Mixer

MAX2043

General Description

The MAX2043 high-linearity passive upconverter or downconverter mixer is designed to provide approximately +31dBm of IIP3, +67dBc of LO \pm 2IF spurious rejection, 7.8dB of noise figure, 7.5dB of conversion loss, and -52dBm of LO leakage for UMTS/WCDMA, DCS, PCS, and WiMAX base-station applications. With a 1700MHz to 3000MHz RF frequency range and a 1900MHz to 3000MHz LO frequency range, this mixer is ideal for high-side LO injection architectures.

In addition to offering excellent linearity and noise performance, the MAX2043 also yields a high level of component integration. The MAX2043 integrates baluns in the RF and LO ports, a dual-input LO-selectable switch, an LO buffer, and a double-balanced mixer. The on-chip baluns allow for a single-ended RF input for down-conversion (or RF output for upconversion), and single-ended LO inputs. The MAX2043 requires a typical 0dBm LO drive, and supply current is rated at a typical 108mA level. The IF port is DC-coupled, making it ideal for direct conversion or modulation. As an upconverter, the device has low output noise floor of less than -160dBc/Hz (-160dBm/Hz when transmitting 0dBm linear RF power).

The MAX2043 is available in a 36-pin thin QFN package (6mm x 6mm) with an exposed paddle. Electrical performance is guaranteed over the extended -40°C to +85°C temperature range.

Applications

UMTS/WCDMA and 3G Base Stations
DCS 1800 and EDGE Base Stations
PCS 1900 and EDGE Base Stations
cdmaOne™ and cdma2000® Base Stations
WiMAX Base Stations and Customer Premise Equipment
Point-to-Point Microwave Systems
Wireless Local Loop
Private Mobile Radio
Digital and Spread-Spectrum Communication Systems
Microwave Links

cdmaOne is a trademark of CDMA Development Group.
cdma2000 is a registered trademark of Telecommunications Industry Association.

Features

- ◆ +31dBm Typical 3rd-Order Input Intercept Point
- ◆ +23dBm Typical Input 1dB Compression Point
- ◆ 1700MHz to 3000MHz RF Frequency Range
- ◆ 1900MHz to 3000MHz LO Frequency Range
- ◆ DC to 350MHz IF Frequency Range
- ◆ 7.5dB Typical Conversion Loss
- ◆ 7.8dB Typical Noise Figure
- ◆ -160dBc/Hz LO Noise
- ◆ -52dBm LO Leakage at RF Port
- ◆ 67dBc LO \pm 2IF Spurious Suppression
- ◆ -3dBm to +6dBm LO Drive
- ◆ +5V Single-Supply Operation
- ◆ Built-In SPDT LO Switch with 43dB LO1 to LO2 Isolation and 50ns Switching Time
- ◆ Internal RF and LO Baluns for Single-Ended Inputs
- ◆ External Current-Setting Resistor Provides Option for Operating Mixer in Reduced Power/Reduced Performance Mode
- ◆ Lead-Free Package Available

Ordering Information

PART	TEMP RANGE	PIN-PACKAGE	PKG CODE
MAX2043ETX	-40°C to +85°C	36 TQFN-EP* (6mm x 6mm)	T3666-2
MAX2043ETX-T	-40°C to +85°C	36 TQFN-EP* (6mm x 6mm)	T3666-2
MAX2043ETX+	-40°C to +85°C	36 TQFN-EP* (6mm x 6mm)	T3666-2
MAX2043ETX+T	-40°C to +85°C	36 TQFN-EP* (6mm x 6mm)	T3666-2

*EP = Exposed paddle.

+Denotes lead-free package.

-T = Tape-and-reel package.

Pin Configuration and Typical Application Circuit appear at end of data sheet.



1700MHz to 3000MHz High-Linearity, Low LO Leakage Base-Station Rx/Tx Mixer

ABSOLUTE MAXIMUM RATINGS

V _{CC} to GND	-0.3V to +5.5V
RF (RF is DC shorted to GND through balun)	50mA
LO1, LO2 to GND	±0.3V
RFTAP, IF+, IF- to GND	-0.3V to (V _{CC} + 0.3V)
LOSEL to GND	-0.3V to (V _{CC} + 0.3V)
RF, IF, and LO Input Power**	+20dBm
LO_ADJ Current	5mA

Continuous Power Dissipation (T _A = +70°C)	
36-Pin TQFN (derated 30.3mW/°C above +70°C)	2200mW
Operating Temperature Range	-40°C to +85°C
Junction Temperature	+150°C
θ _{JC}	+7.4°C/W
θ _{JA}	+38°C/W
Storage Temperature Range	-65°C to +150°C
Lead Temperature (soldering, 10s)	+300°C

**Maximum reliable continuous input power applied to the RF, IF, and LO ports of this device is +15dBm from a 50Ω source.

Stresses beyond those listed under "Absolute Maximum Ratings" may cause permanent damage to the device. These are stress ratings only, and functional operation of the device at these or any other conditions beyond those indicated in the operational sections of the specifications is not implied. Exposure to absolute maximum rating conditions for extended periods may affect device reliability.

DC ELECTRICAL CHARACTERISTICS

(MAX2043 Typical Application Circuit, V_{CC} = +4.75V to +5.25V, no RF signals applied, IF+ and IF- DC grounded through a transformer, T_C = -40°C to +85°C. A 360Ω resistor is connected from LO_ADJ to GND. Typical values are at V_{CC} = +5V, T_C = +25°C, unless otherwise noted.)

PARAMETER	SYMBOL	CONDITIONS	MIN	TYP	MAX	UNITS
Supply Voltage	V _{CC}		4.75	5	5.25	V
Supply Current	I _{CC}	Total supply current		108	140	mA
LOSEL Logic 0 Input Voltage	V _{IL}				0.8	V
LOSEL Logic 1 Input Voltage	V _{IH}		2			V
LOSEL Logic Input Current	I _{IH} and I _{IL}		-10		+10	μA

AC ELECTRICAL CHARACTERISTICS (Downconverter Operation)

(MAX2043 Typical Application Circuit, V_{CC} = +4.75V to +5.25V, RF and LO ports are driven from 50Ω sources, P_{LO} = -3dBm to +3dBm, P_{RF} = 0dBm, f_{RF} = 1700MHz to 3000MHz, f_{LO} = 1900MHz to 3000MHz, f_{IF} = 200MHz, f_{RF} < f_{LO}, T_C = -40°C to +85°C, unless otherwise noted. Typical values are at V_{CC} = +5V, P_{RF} = 0dBm, P_{LO} = 0dBm, f_{RF} = 1900MHz, f_{LO} = 2100MHz, f_{IF} = 200MHz, T_C = +25°C, unless otherwise noted.) (Note 1)

PARAMETER	SYMBOL	CONDITIONS	MIN	TYP	MAX	UNITS
RF Frequency	f _{RF}		1700		3000	MHz
LO Frequency	f _{LO}		1900		3000	MHz
IF Frequency (Notes 1, 2)	f _{IF}		0		350	MHz
Small-Signal Conversion Loss	L _C	DCS 1800: P _{RF} = -10dBm, P _{LO} = 0dBm, f _{IF} = 200MHz, f _{RF} = 1710MHz to 1785MHz		7.5		dB
		PCS 1900: P _{RF} = -10dBm, P _{LO} = 0dBm, f _{IF} = 200MHz, f _{RF} = 1850MHz to 1910MHz		7.5		
		UMTS 2100: P _{RF} = -10dBm, P _{LO} = 0dBm, f _{IF} = 200MHz, f _{RF} = 1920MHz to 1980MHz		7.5		
Conversion Loss Variation from Nominal		DCS 1800: f _{RF} = 1710MHz to 1785MHz		±0.5		dB
		PCS 1900: f _{RF} = 1850MHz to 1910MHz		±0.5		
		UMTS 2100: f _{RF} = 1920MHz to 1980MHz		±0.5		

1700MHz to 3000MHz High-Linearity, Low LO Leakage Base-Station Rx/Tx Mixer

MAX2043

AC ELECTRICAL CHARACTERISTICS (Downconverter Operation) (continued)

(MAX2043 *Typical Application Circuit*, $V_{CC} = +4.75V$ to $+5.25V$, RF and LO ports are driven from 50Ω sources, $P_{LO} = -3dBm$ to $+3dBm$, $P_{RF} = 0dBm$, $f_{RF} = 1700MHz$ to $3000MHz$, $f_{LO} = 1900MHz$ to $3000MHz$, $f_{IF} = 200MHz$, $f_{RF} < f_{LO}$, $T_C = -40^\circ C$ to $+85^\circ C$, unless otherwise noted. Typical values are at $V_{CC} = +5V$, $P_{RF} = 0dBm$, $P_{LO} = 0dBm$, $f_{RF} = 1900MHz$, $f_{LO} = 2100MHz$, $f_{IF} = 200MHz$, $T_C = +25^\circ C$, unless otherwise noted.) (Note 1)

PARAMETER	SYMBOL	CONDITIONS	MIN	TYP	MAX	UNITS
Conversion Loss Variation Over Temperature		$T_C = -40^\circ C$ to $+85^\circ C$		0.0075		dB/ $^\circ C$
Noise Figure, Single Sideband	NF	$T_C = +25^\circ C$, DCS 1800: $f_{RF} = 1710MHz$ to $1785MHz$		7.8		dB
		$T_C = +25^\circ C$, PCS 1900: $f_{RF} = 1850MHz$ to $1910MHz$		7.8		
		$T_C = +25^\circ C$, UMTS 2100: $f_{RF} = 1920MHz$ to $1980MHz$		7.8		
Noise Figure Under Blocking Condition (Note 3)		PBLOCKER = $+5dBm$ at $2100MHz$, $f_{RF} = 2000MHz$, $f_{LO} = 2190MHz$, $P_{LO} = 0dBm$		19		dB
Input Compression Point (Note 4)	IP1dB	High-side injection		+23		dBm
3rd-Order Input Intercept Point	IIP3	High-side injection, $f_{RF1} = 1900MHz$, $f_{RF2} = 1901MHz$, $0dBm$ per tone at RF port		31		dBm
3rd-Order Input Intercept Point Variation		$T_C = -40^\circ C$ to $+85^\circ C$		± 0.75		dB
2LO - 2RF Spur		$f_{RF} = 1900MHz$, $f_{LO} = 2100MHz$, $f_{SPUR} = 2000MHz$, $P_{RF} = 0dBm$, $P_{LO} = 0dBm$		63		dBc
3LO - 3RF Spur		$f_{RF} = 1900MHz$, $f_{LO} = 2100MHz$, $f_{SPUR} = 2033.333MHz$, $P_{RF} = 0dBm$, $P_{LO} = 0dBm$		67		dBc
LO Drive (Note 5)	P_{LO}		-3	0	+6	dBm
LO1-to-LO2 Port Isolation		$P_{LO1} = P_{LO2} = +3dBm$, $f_{IF} = 200MHz$ (Note 6)		43		dB
LO Leakage at RF Port		$P_{LO} = +3dBm$, $f_{LO} = 2260MHz$		-52	-38	dBm
LO Switching Time		50% of LOSEL to IF settled within 2 degrees		50		ns
LO Leakage at IF Port		$P_{LO} = +3dBm$		-35		dBm
RF-to-IF Isolation		$P_{LO} = +3dBm$		38		dB
RF Input Return Loss		LO on and IF terminated		17		dB
LO Input Return Loss		RF and IF terminated		14		dB
IF Return Loss		RF and LO terminated in 50Ω , $f_{IF} = 200MHz$ (Note 7)		20		dB

1700MHz to 3000MHz High-Linearity, Low LO Leakage Base-Station Rx/Tx Mixer

AC ELECTRICAL CHARACTERISTICS (Upconverter Operation)

(MAX2043 *Typical Application Circuit*, $V_{CC} = +4.75V$ to $+5.25V$, $P_{LO} = -3dBm$ to $+3dBm$, $P_{IF} = 0dBm$, $f_{RF} = 1700MHz$ to $3000MHz$, $f_{LO} = 1900MHz$ to $3000MHz$, $f_{IF} = 200MHz$, $f_{RF} = f_{LO} - f_{IF}$, $T_C = -40^{\circ}C$ to $+85^{\circ}C$, unless otherwise noted. Typical values are at $V_{CC} = +5V$, $P_{IF} = 0dBm$, $P_{LO} = 0dBm$, $f_{RF} = 2170MHz$, $f_{LO} = 2260MHz$, $f_{IF} = 90MHz$, $T_C = +25^{\circ}C$, unless otherwise noted.) (Note 3)

PARAMETER	SYMBOL	CONDITIONS	MIN	TYP	MAX	UNITS
Input Compression Point	IP1dB			23		dBm
3rd-Order Input Intercept Point	IIP3	Two tones: $f_{IF1} = 90MHz$, $f_{IF2} = 91MHz$, $P_{IF} = +5dBm/$ tone, $f_{LO} = 2230MHz$, $P_{LO} = 0dBm$		28		dBm
LO \pm 2IF Spur		LO - 2IF	60	67		dBc
		LO + 2IF	60	69		
LO \pm 3IF Spur		LO - 3IF		63		dBc
		LO + 3IF		64		
Output Noise Floor		$P_{OUT} = 0dBm$		-160		dBm/Hz

Note 1: All limits reflect losses of external components. Output measurement taken at IF port of *Typical Application Circuit*.

Note 2: The lower IF frequency limit of 0MHz is limited by the external IF transformer.

Note 3: Measured with external LO source noise filtered so its noise floor is not a contributor. Measured with: $f_{RF} = 2000MHz$, $f_{BLOCKER} = 2100MHz$, $f_{LO} = 2190MHz$, using a 190MHz SAW filter on the IF port. This specification reflects the effects of all SNR degradations in the mixer, including the LO noise as defined in Maxim Application Note 2021.

Note 4: Maximum reliable continuous input power applied to the RF or IF port of this device is $+15dBm$ from a 50Ω source.

Note 5: *Typical Operating Characteristics* show LO drive extended to $+6dBm$

Note 6: Measured IF port at IF frequency. f_{LO1} and f_{LO2} are offset by 1MHz.

Note 7: IF return loss can be optimized by external matching components.

Typical Operating Characteristics

(MAX2043 *Typical Application Circuit*, C2 not installed, RFTAP = GND, $V_{CC} = +5.0V$, $P_{LO} = 0dBm$, LOSEL = "0" (LO2 selected), $P_{RF} = 0dBm$, $f_{LO} > f_{RF}$, $f_{IF} = 200MHz$, unless otherwise noted.)

Downconverter Curves

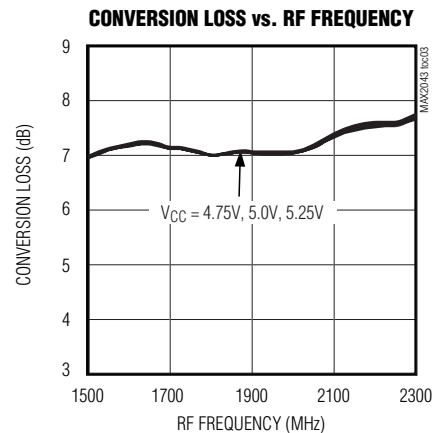
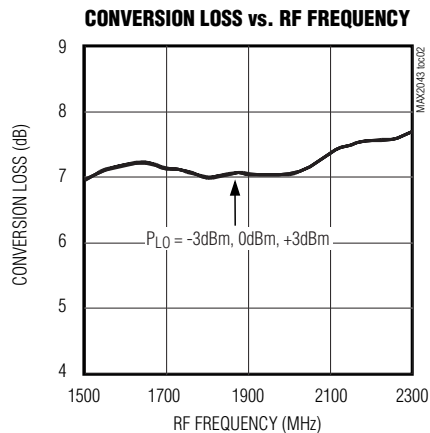
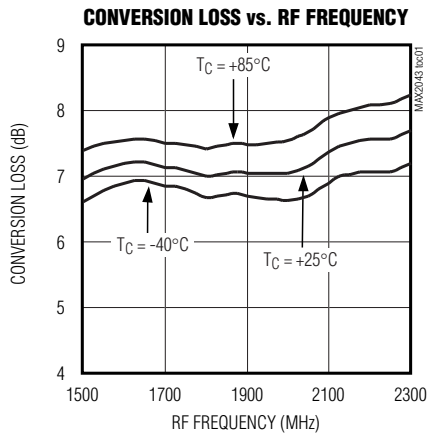

1700MHz to 3000MHz High-Linearity, Low LO Leakage Base-Station Rx/Tx Mixer

MAX2043

Typical Operating Characteristics (continued)

(MAX2043 Typical Application Circuit, C2 not installed, RFTAP = GND, VCC = +5.0V, P_{LO} = 0dBm, LOSEL = "0" (LO2 selected), P_{RF} = 0dBm, f_{LO} > f_{RF}, f_{IF} = 200MHz, unless otherwise noted.)

Downconverter Curves

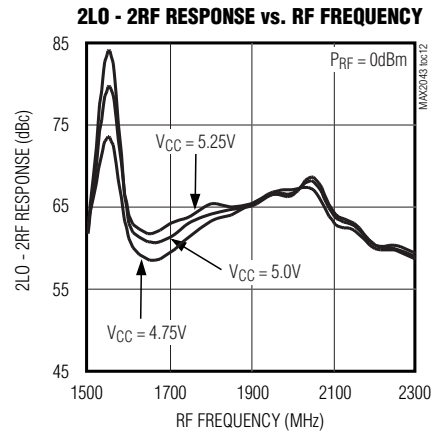
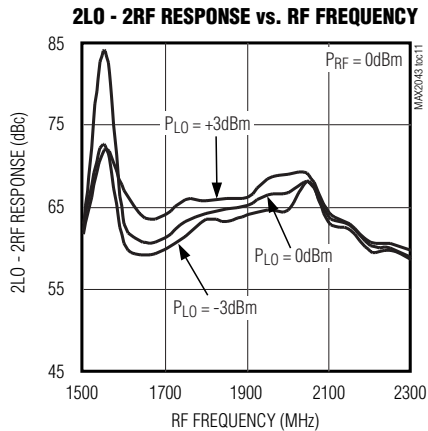
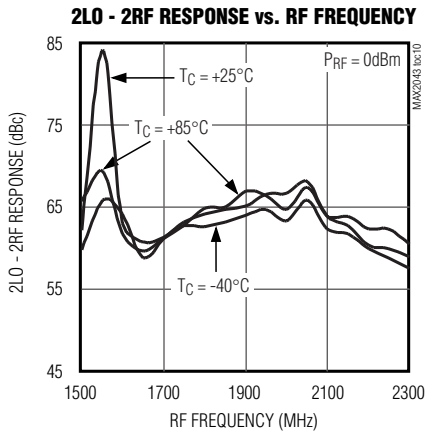
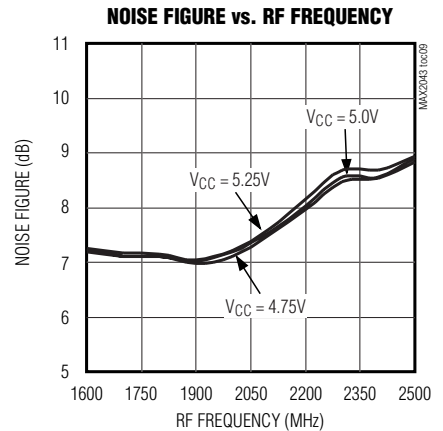
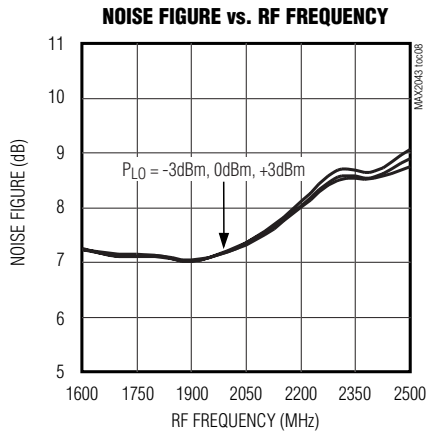
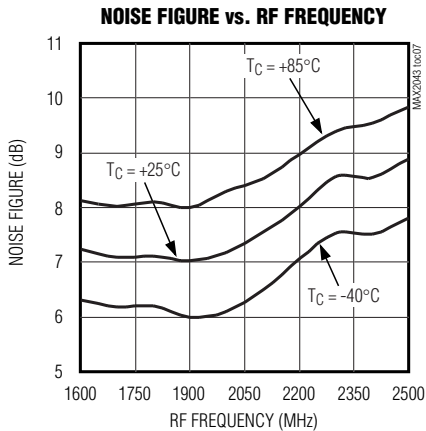
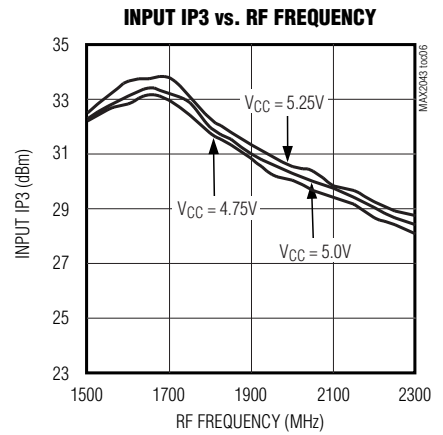
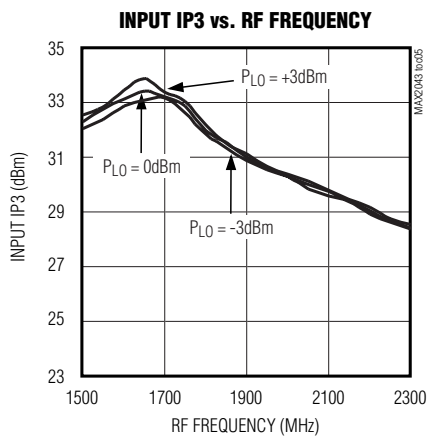
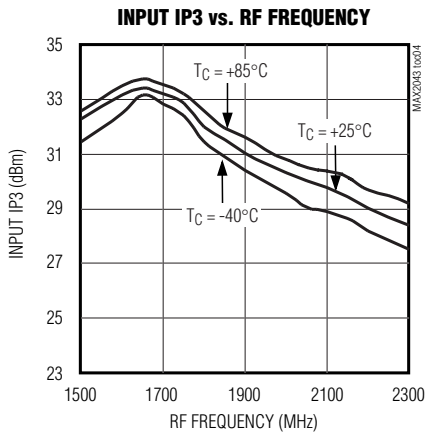

1700MHz to 3000MHz High-Linearity, Low LO Leakage Base-Station Rx/Tx Mixer

Typical Operating Characteristics (continued)

(MAX2043 Typical Application Circuit, C2 not installed, RFTAP = GND, VCC = +5.0V, P_{LO} = 0dBm, LOSEL = "0" (LO2 selected), P_{RF} = 0dBm, f_{LO} > f_{RF}, f_{IF} = 200MHz, unless otherwise noted.)

Downconverter Curves

2LO - 2RF RESPONSE vs. RF FREQUENCY
LOSEL = "1" (LO1 SELECTED)

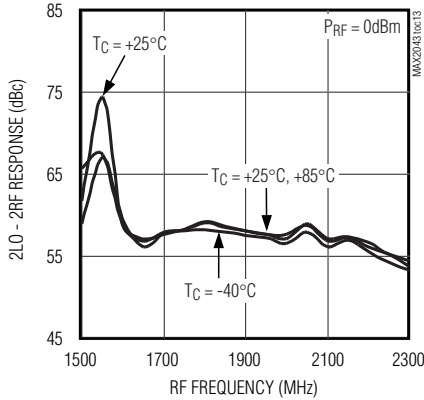

2LO - 2RF RESPONSE vs. RF FREQUENCY
LOSEL = "1" (LO1 SELECTED)

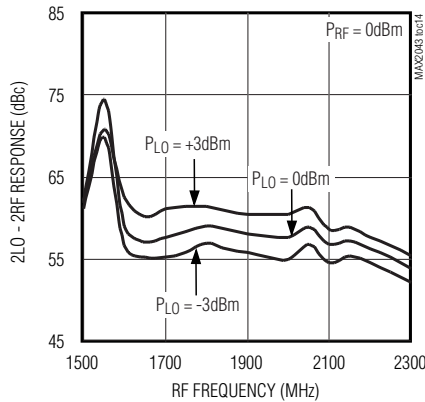

2LO - 2RF RESPONSE vs. RF FREQUENCY
LOSEL = "1" (LO1 SELECTED)

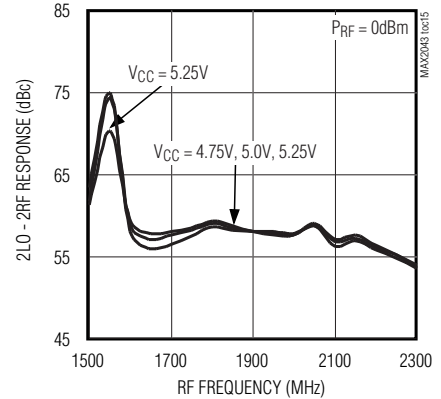

3LO - 3RF RESPONSE vs. RF FREQUENCY

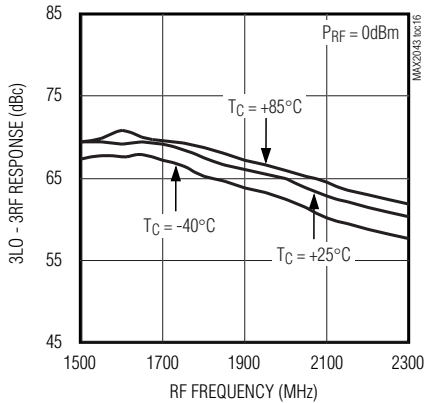

3LO - 3RF RESPONSE vs. RF FREQUENCY

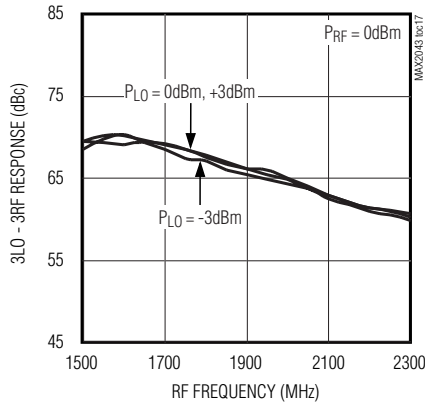

3LO - 3RF RESPONSE vs. RF FREQUENCY

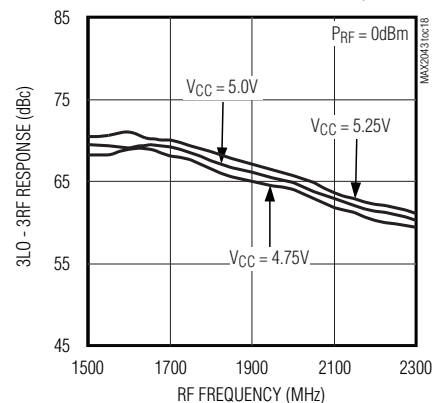

INPUT P_{1dB} vs. RF FREQUENCY

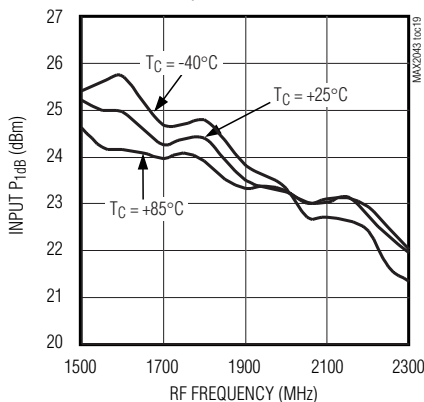

INPUT P_{1dB} vs. RF FREQUENCY

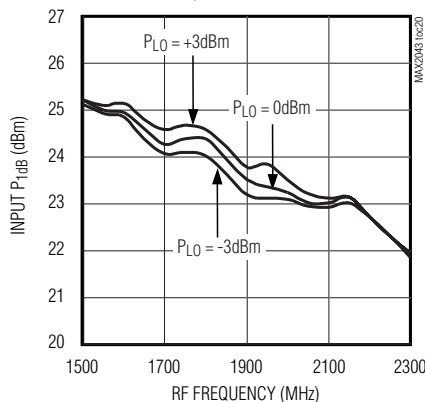

INPUT P_{1dB} vs. RF FREQUENCY

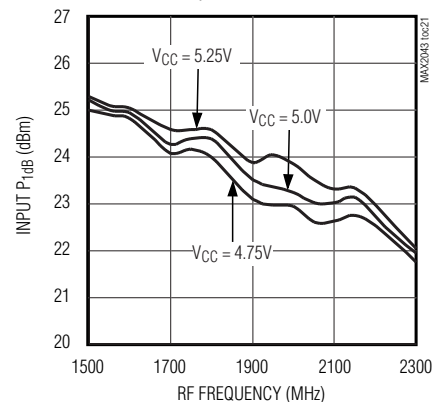

1700MHz to 3000MHz High-Linearity, Low LO Leakage Base-Station Rx/Tx Mixer

MAX2043

Typical Operating Characteristics (continued)

(MAX2043 Typical Application Circuit, C2 not installed, RFTAP = GND, VCC = +5.0V, P_{LO} = 0dBm, LOSEL = "0" (LO2 selected), P_{RF} = 0dBm, f_{LO} > f_{RF}, f_IF = 200MHz, unless otherwise noted.)

Downconverter Curves

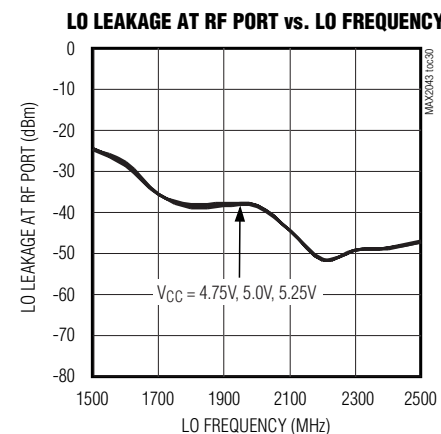
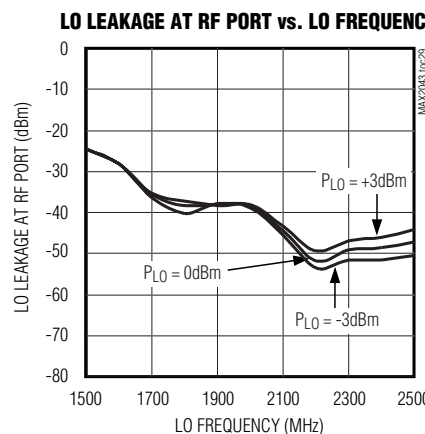
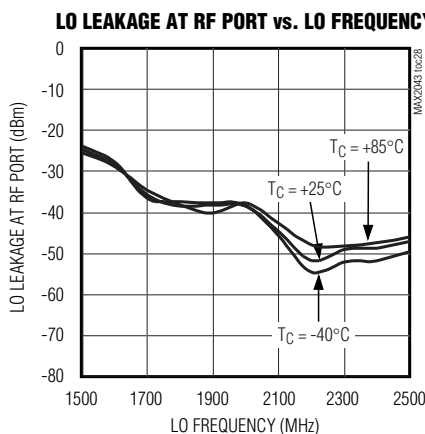
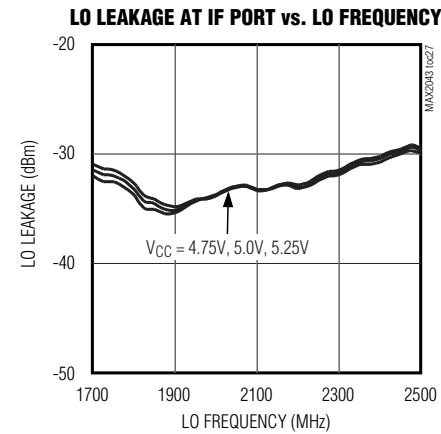
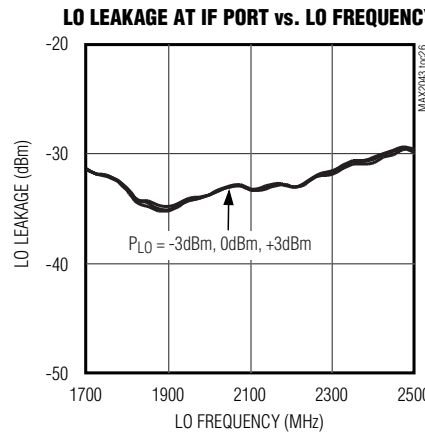
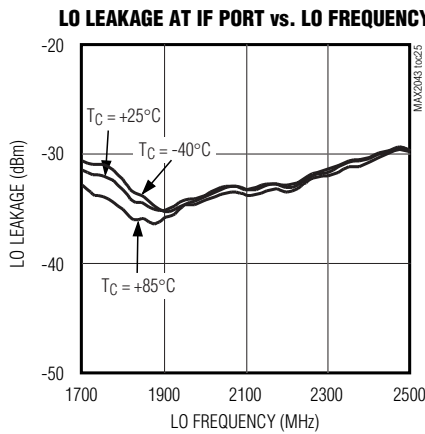
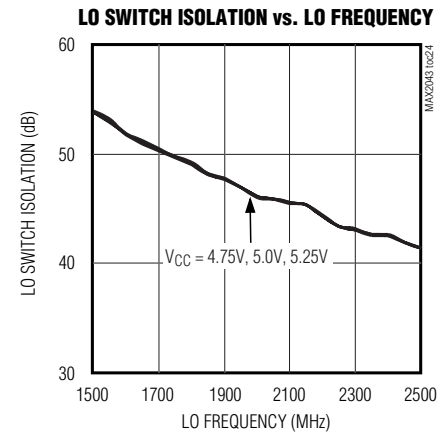
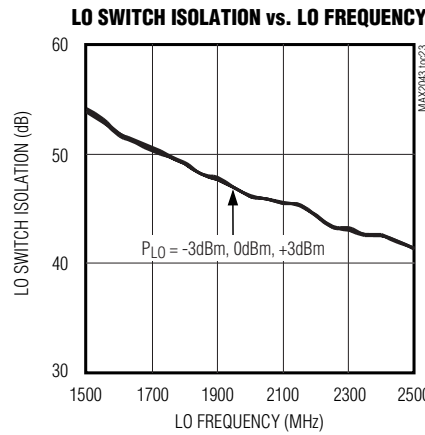
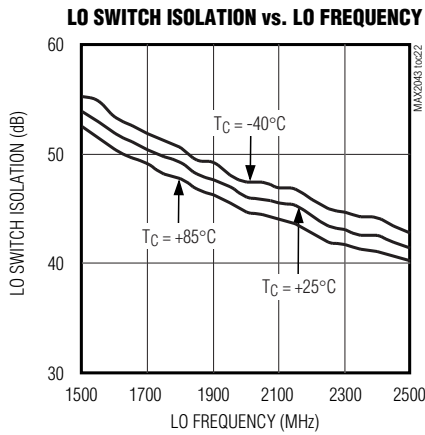

1700MHz to 3000MHz High-Linearity, Low LO Leakage Base-Station Rx/Tx Mixer

Typical Operating Characteristics (continued)

(MAX2043 Typical Application Circuit, C2 not installed, RFTAP = GND, VCC = +5.0V, P_{LO} = 0dBm, LOSEL = "0" (LO2 selected), P_{RF} = 0dBm, f_{LO} > f_{RF}, f_{IF} = 200MHz, unless otherwise noted.)

Downconverter Curves

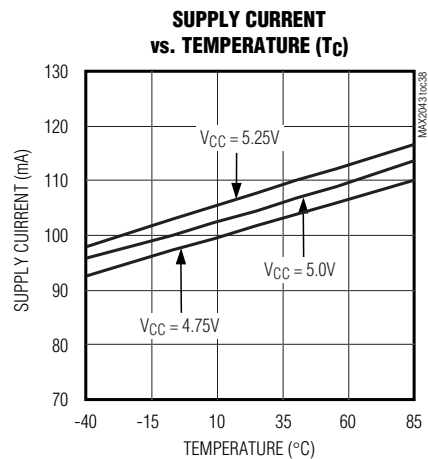
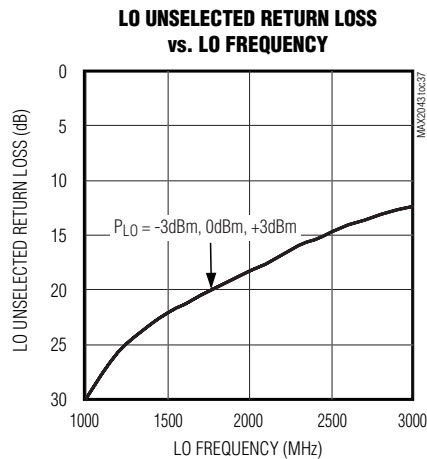
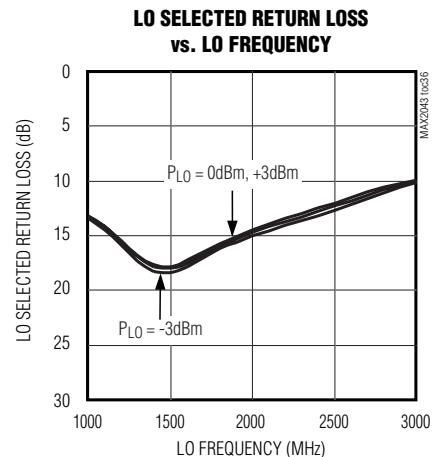
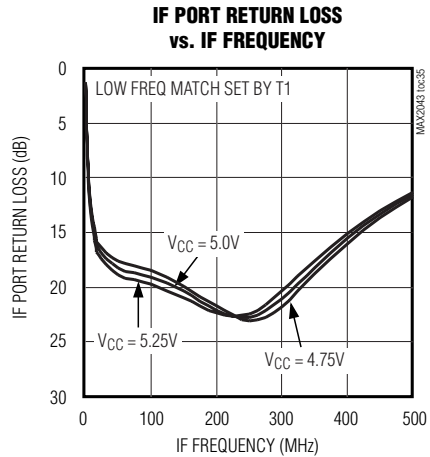
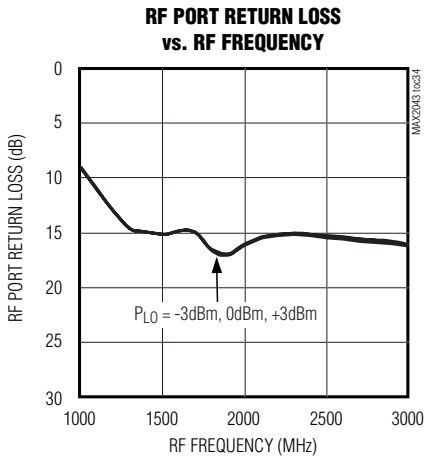
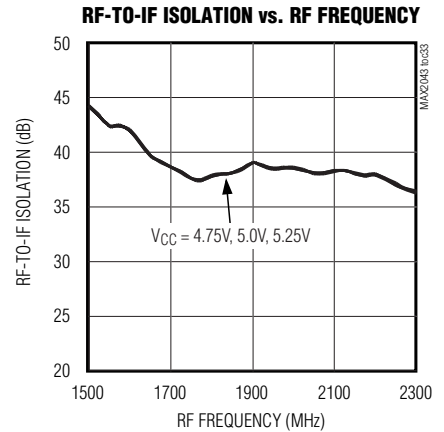
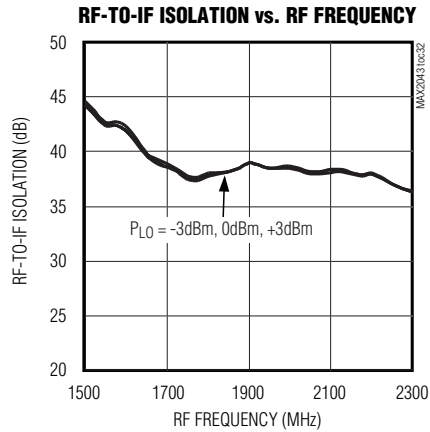
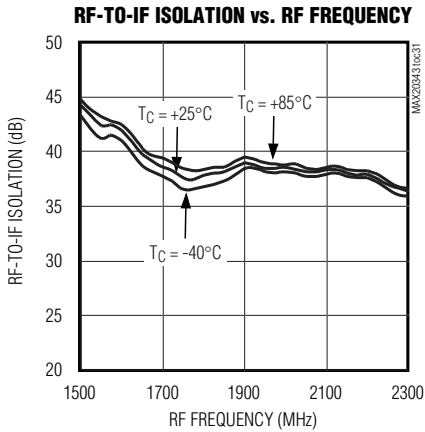

1700MHz to 3000MHz High-Linearity, Low LO Leakage Base-Station Rx/Tx Mixer

MAX2043

Typical Operating Characteristics

(MAX2043 Typical Application Circuit, C2 = 22pF, V_{CC} = +5.0V, P_{LO} = 0dBm, LOSEL = "1" (LO1 selected), P_{IF} = 0dBm, f_{RF} = f_{LO} - f_{IF}, f_{IF} = 90MHz, unless otherwise noted.)

Upconverter Curves

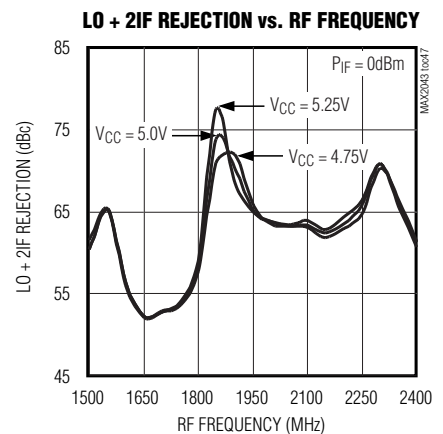
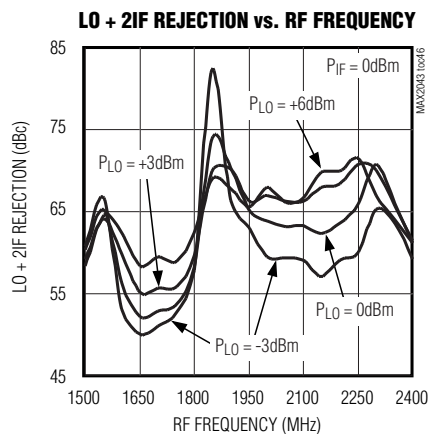
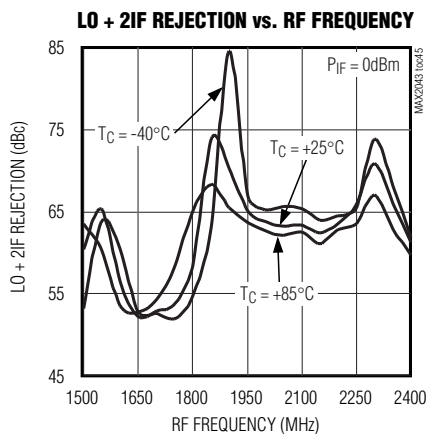
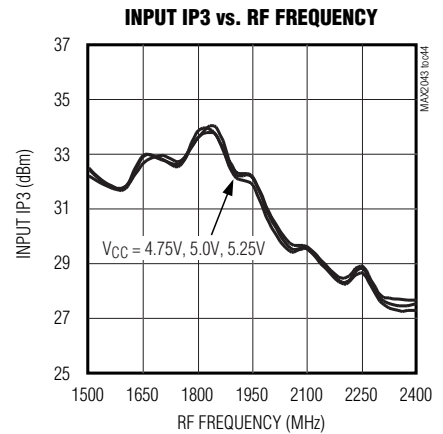
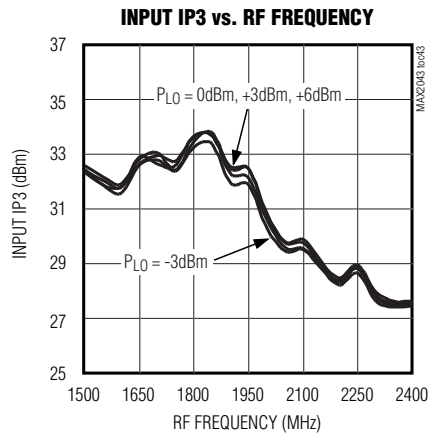
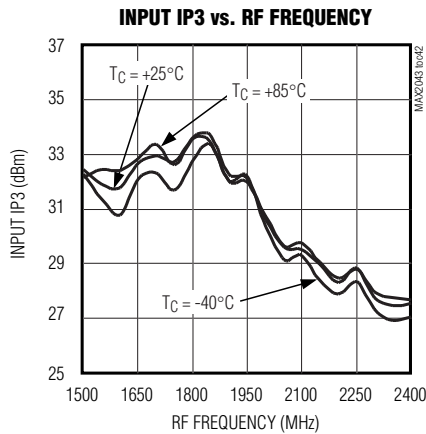
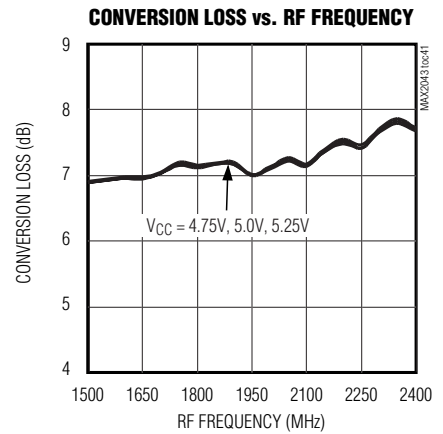
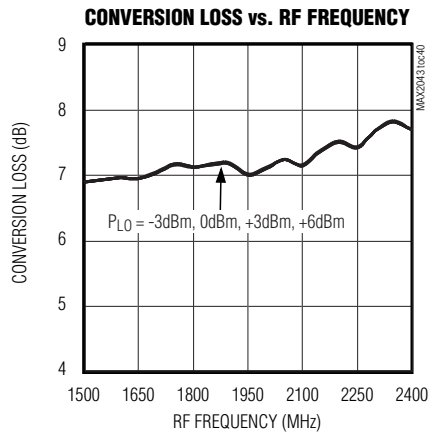
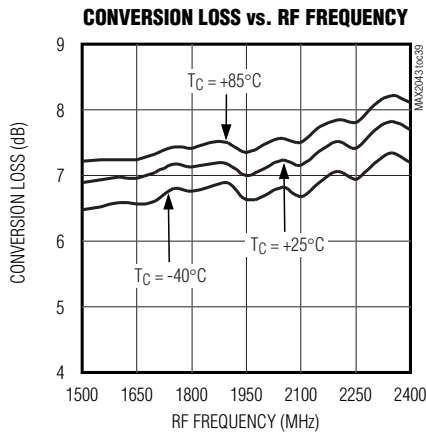

1700MHz to 3000MHz High-Linearity, Low LO Leakage Base-Station Rx/Tx Mixer

Typical Operating Characteristics (continued)

(MAX2043 Typical Application Circuit, $C2 = 22\text{pF}$, $V_{CC} = +5.0\text{V}$, $P_{LO} = 0\text{dBm}$, LOSEL = "1" (LO1 selected), $P_{IF} = 0\text{dBm}$, $f_{RF} = f_{LO} - f_{IF}$, $f_{IF} = 90\text{MHz}$, unless otherwise noted.)

Upconverter Curves

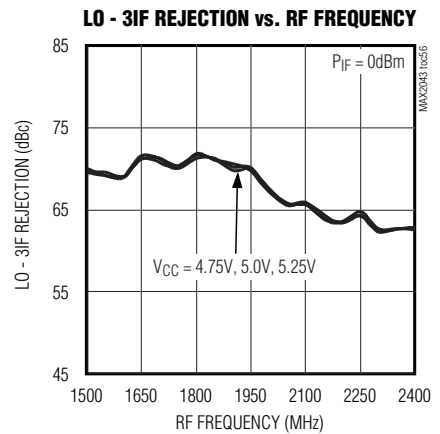
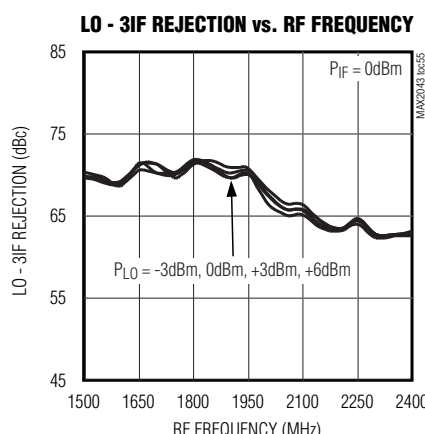
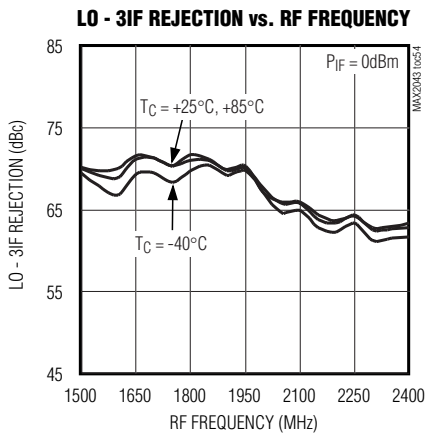
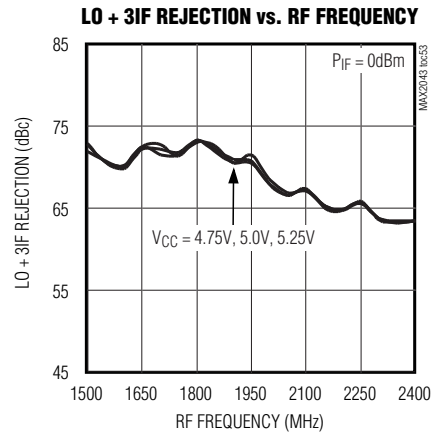
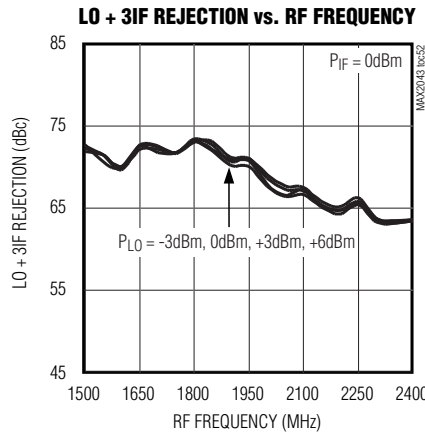
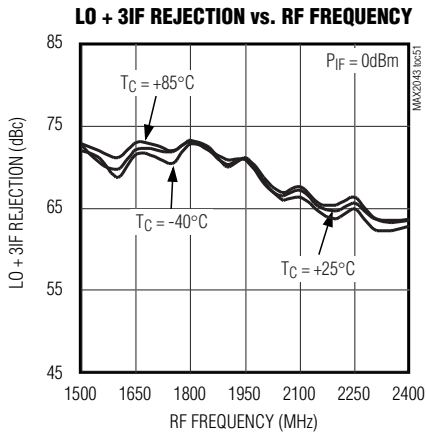
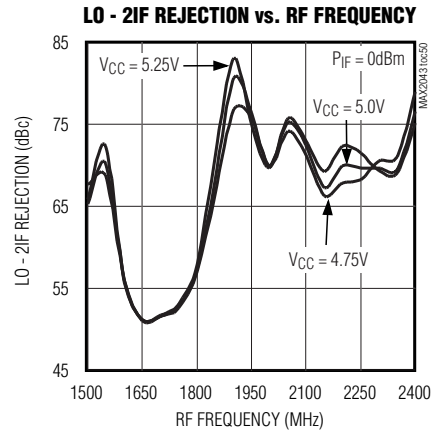
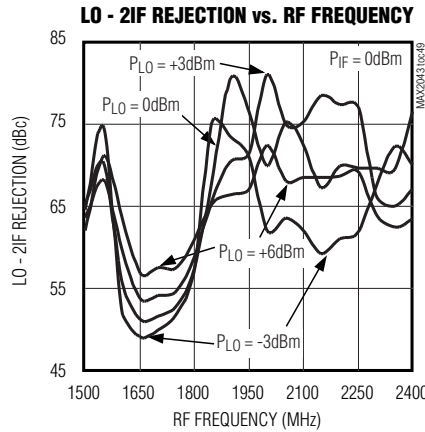
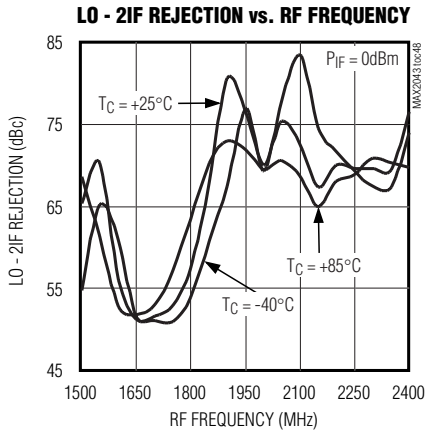

1700MHz to 3000MHz High-Linearity, Low LO Leakage Base-Station Rx/Tx Mixer

MAX2043

Typical Operating Characteristics (continued)

(MAX2043 Typical Application Circuit, $C2 = 22\text{pF}$, $V_{CC} = +5.0\text{V}$, $P_{LO} = 0\text{dBm}$, LOSEL = "1" (LO1 selected), $P_{IF} = 0\text{dBm}$, $f_{RF} = f_{LO} - f_{IF}$, $f_{IF} = 90\text{MHz}$, unless otherwise noted.)

Upconverter Curves

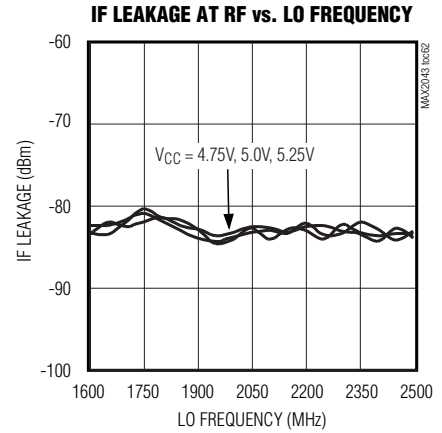
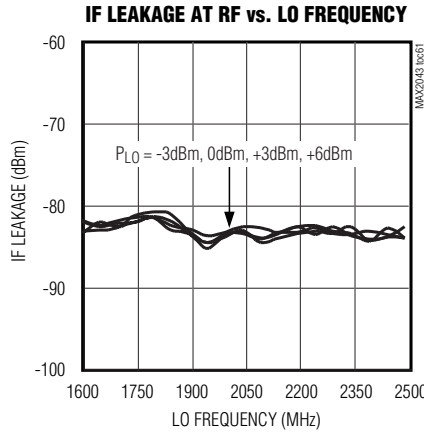
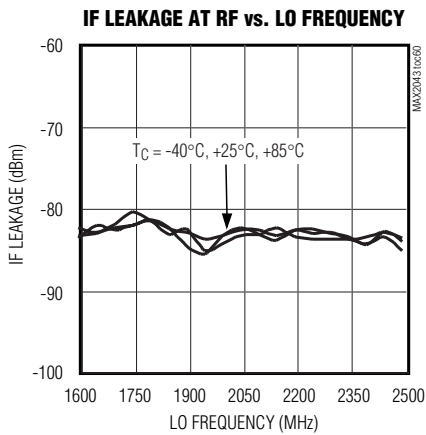
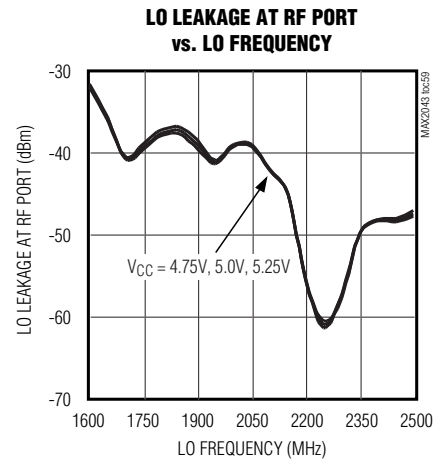
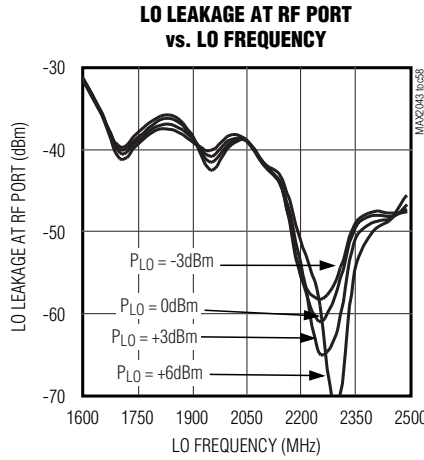
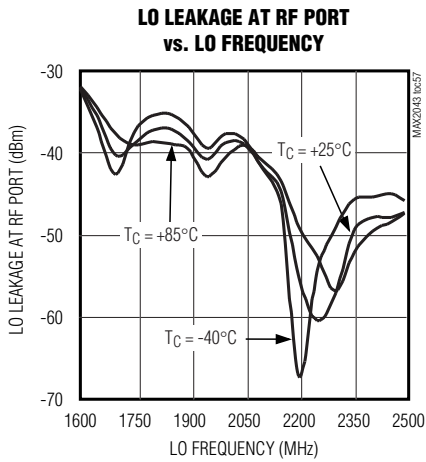

1700MHz to 3000MHz High-Linearity, Low LO Leakage Base-Station Rx/Tx Mixer

Pin Description

PIN	NAME	FUNCTION
1–5, 7, 10, 11, 12, 15, 18, 20, 22, 24, 25, 26, 28, 29, 31–36	GND	These pins have no internal connection and can be left open or connected to ground. It is suggested that these pins be grounded back to the exposed paddle where possible to improve pin-to-pin isolation.
6, 16, 21, 30	VCC	Power-Supply Connection. Connected to external power supply (5V). Bypass to GND with a 0.01 μ F capacitor as close to the pin as possible.
8	RFTAP	Center Tap of the Internal RF Balun. Connected to internal RF balun center tap.
9	RF	Single-Ended 50 Ω RF Input/Output. DC grounded internally.
13, 14	IF+, IF- (ports)	Differential IF Ports (50 Ω). 0V common-mode voltage.
17	LO_ADJ	Adjust LO Drive. A 360 Ω \pm 1% resistor connected from this pin to ground sets the LO driver bias. A 1.1V DC voltage appears across this resistor.
19	LO1	Local Oscillator Input 1. Drive LOSEL high to select LO1.
23	LOSEL	Local Oscillator Select. Logic 0 selects LO2 and 1 selects LO1.
27	LO2	Local Oscillator Input 2. Drive LOSEL low to select LO2.
EP	GND	Exposed Paddle. Ground the exposed paddle using multiple ground vias.

Detailed Description

The MAX2043 can operate as either a downconverter or an upconverter mixer that provides 7.5dB of conversion loss with a typical 7.8dB noise figure. IIP3 is +31dBm for both upconversion and downconversion. The integrated baluns and matching circuitry allow for 50 Ω single-ended interfaces to the RF port and two LO ports. The RF port can be used as an input for downconversion or an output for upconversion. A single-pole, double-throw (SPDT) switch provides 50ns switching time between the two LO inputs with 43dB of LO-to-LO isolation and -52dBm of LO leakage. Furthermore, the integrated LO buffer provides a high drive level to the mixer core, reducing the LO drive required at the MAX2043's inputs to a -3dBm to +6dBm range. The IF port incorporates a differential output for downconversion, which is ideal for providing enhanced IIP2 performance. For upconversion, the IF port is a differential input.

Specifications are guaranteed over broad frequency ranges to allow for use in UMTS/WCDMA and 2G/2.5G/3G DCS 1800, PCS 1900, cdma2000, and WiMAX base stations. The MAX2043 is specified to operate over a 1700MHz to 3000MHz RF input range, a 1900MHz to 3000MHz LO range, and an IF range of near 0MHz to 350MHz. The external IF component sets the lower frequency range.

RF Port and Balun

For using the MAX2043 as a downconverter, the RF input is internally matched to 50 Ω , requiring no external matching components. A DC-blocking capacitor is required because the input is internally DC shorted to ground through the on-chip balun. The RF return loss is typically 15dB over the entire 1700MHz to 3000MHz RF frequency range. For upconverter operation, the RF port is a single-ended output similarly matched to 50 Ω .

An optional L-C BPF can be installed at the RF port to improve some upconverter performance.

LO Inputs, Buffer, and Balun

The MAX2043 is optimized for a 1900MHz to 3000MHz LO range. As an added feature, the MAX2043 includes an internal LO SPDT switch that can be used for frequency-hopping applications. The switch selects one of the two single-ended LO ports, allowing the external oscillator to settle on a particular frequency before it is switched in. LO switching time is typically less than 50ns, which is more than adequate for typical GSM applications. If frequency-hopping is not employed, simply set the switch to either of the LO inputs. The switch is controlled by a digital input (LOSEL): logic-high selects LO1, logic-low selects LO2. LO1 and LO2 inputs are internally matched to 50 Ω , requiring only a 22pF DC-blocking capacitor. To avoid damage to the

1700MHz to 3000MHz High-Linearity, Low LO Leakage Base-Station Rx/Tx Mixer

part, voltage **MUST** be applied to VCC before digital logic is applied to LOSEL.

A two-stage internal LO buffer allows a wide input power range for the LO drive. All guaranteed specifications are for an LO signal power from -3dBm to +6dBm. The on-chip low-loss balun along with an LO buffer drives the double-balanced mixer. All interfacing and matching components from the LO inputs to the IF outputs are integrated on-chip.

High-Linearity Mixer

The core of the MAX2043 is a double-balanced, high-performance passive mixer. Exceptional linearity is provided by the large LO swing from the on-chip LO buffer.

Differential IF

The MAX2043 mixer has a DC to 350MHz IF frequency range where the low-end frequency depends on the frequency response of the external IF components. Note that these differential ports are ideal for providing enhanced IIP2 performance. Single-ended IF applications require a 1:1 balun to transform the 50Ω differential IF impedance to 50Ω single-ended system. After the balun, the IF return loss is better than 20dB. The user can use a differential IF amplifier on the mixer IF ports, but a DC block is required on both IF+ and IF- ports to keep external DC from entering the IF ports of the mixer. The mixer requires a DC ground return on either the RF tap pin (short tap to ground) or on each IF differential port (1kΩ resistor or an inductor from each IF differential pin to ground).

Applications Information

Input and Output Matching

The RF and LO inputs are internally matched to 50Ω. No matching components are required. Return loss at the RF port is typically 17dB and return loss at the LO ports are typically 14dB. RF and LO inputs require only DC-blocking capacitors for interfacing.

The IF output impedance is 50Ω (differential). For evaluation, an external low-loss 1:1 (impedance ratio) balun transforms this impedance to a 50Ω single-ended output (see the *Typical Application Circuit*).

Bias Resistor

Bias current for the on-chip LO buffer is optimized by fine-tuning the off-chip resistor on pin 17 (R1). The current in the buffer amplifier can be reduced by raising the value of this resistor but performance (especially IP3) degrades. Doubling the value of this resistor reduces the current in the device by approximately half.

Additional Tuning Components

The MAX2043 mixer performance can be further enhanced with the use of external components. The values of these components depend on the application and the frequency band of interest. Consult the factory for further details.

Layout Considerations

A properly designed PC board is an essential part of any RF/microwave circuit. Keep RF signal lines as short as possible to reduce losses, radiation, and inductance. For the best performance, route the ground pin traces directly to the exposed pad under the package. The PC board exposed pad **MUST** be connected to the ground plane of the PC board. It is suggested that multiple vias be used to connect this pad to the lower-level ground planes. This method provides a good RF/thermal conduction path for the device. Solder the exposed pad on the bottom of the device package to the PC board. The MAX2043 evaluation kit can be used as a reference for board layout. Gerber files are available upon request at www.maxim-ic.com.

Power-Supply Bypassing

Proper voltage supply bypassing is essential for high-frequency circuit stability. Bypass each VCC pin and TAP with the capacitors shown in the *Typical Application Circuit*. See Table 1. Place the TAP bypass capacitor to ground within 100 mils of the TAP pin.

Exposed Pad RF/Thermal Considerations

The exposed paddle (EP) of the MAX2043's 36-pin thin QFN-EP package provides a low thermal-resistance path to the die. It is important that the PC board on which the MAX2043 is mounted be designed to conduct heat from the EP. In addition, provide the EP with a low-inductance path to electrical ground. The EP **MUST** be soldered to a ground plane on the PC board, either directly or through an array of plated via holes.

1700MHz to 3000MHz High-Linearity, Low LO Leakage Base-Station Rx/Tx Mixer

Chip Information

PROCESS: SiGe BiCMOS

Table 1. Component List Referring to the Typical Application Circuit

COMPONENT	VALUE	DESCRIPTION
C1	4pF	Microwave capacitor (0402)
C2*, C4, C6, C8	22pF	Microwave capacitors (0402)
C3	Not used	Microwave capacitor (0603)
C5, C7, C9	0.01μF	Microwave capacitors (0402)
R1	360Ω	360Ω ±1% resistor (0402)
T1	1:1	Transformer (50:50) M/A-COM MABAES0029
U1	MAX2043	Maxim IC

*Ground pin 8 for downconverter operation.

Pin Configuration

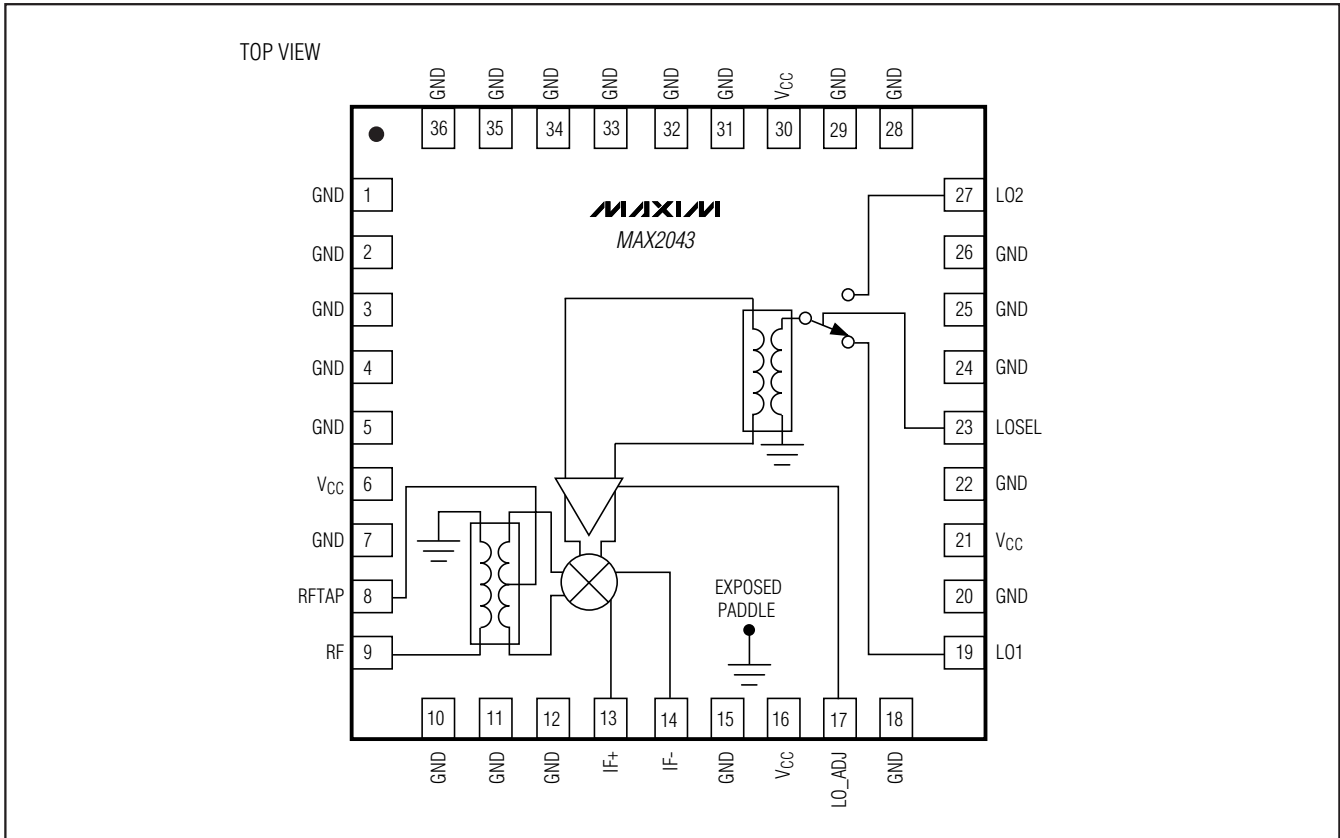

1700MHz to 3000MHz High-Linearity, Low LO Leakage Base-Station Rx/Tx Mixer

Typical Application Circuit

MAX2043

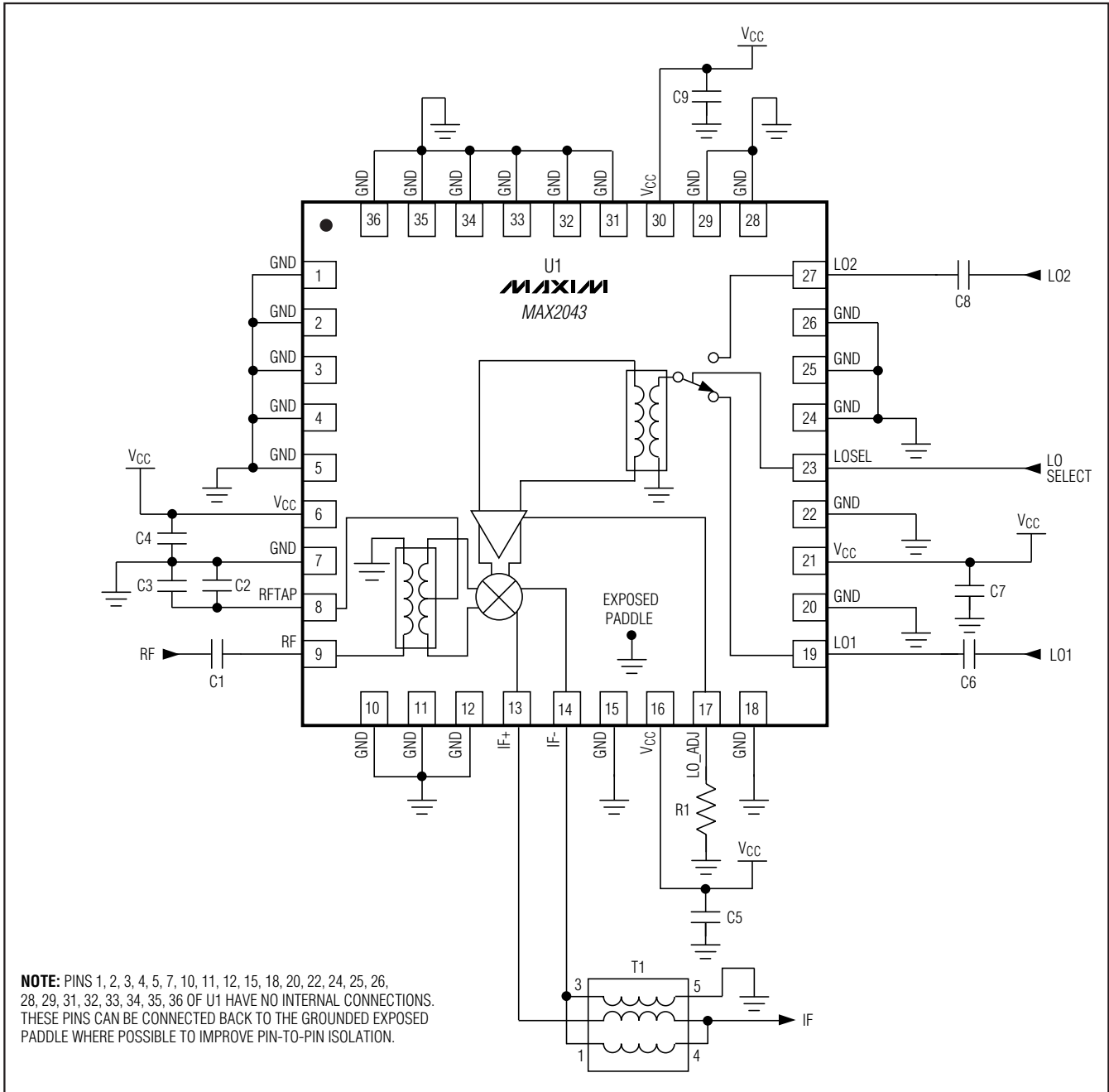

1700MHz to 3000MHz High-Linearity, Low LO Leakage Base-Station Rx/Tx Mixer

Package Information

(The package drawing(s) in this data sheet may not reflect the most current specifications. For the latest package outline information, go to www.maxim-ic.com/packages.)

QFN THIN.EPS

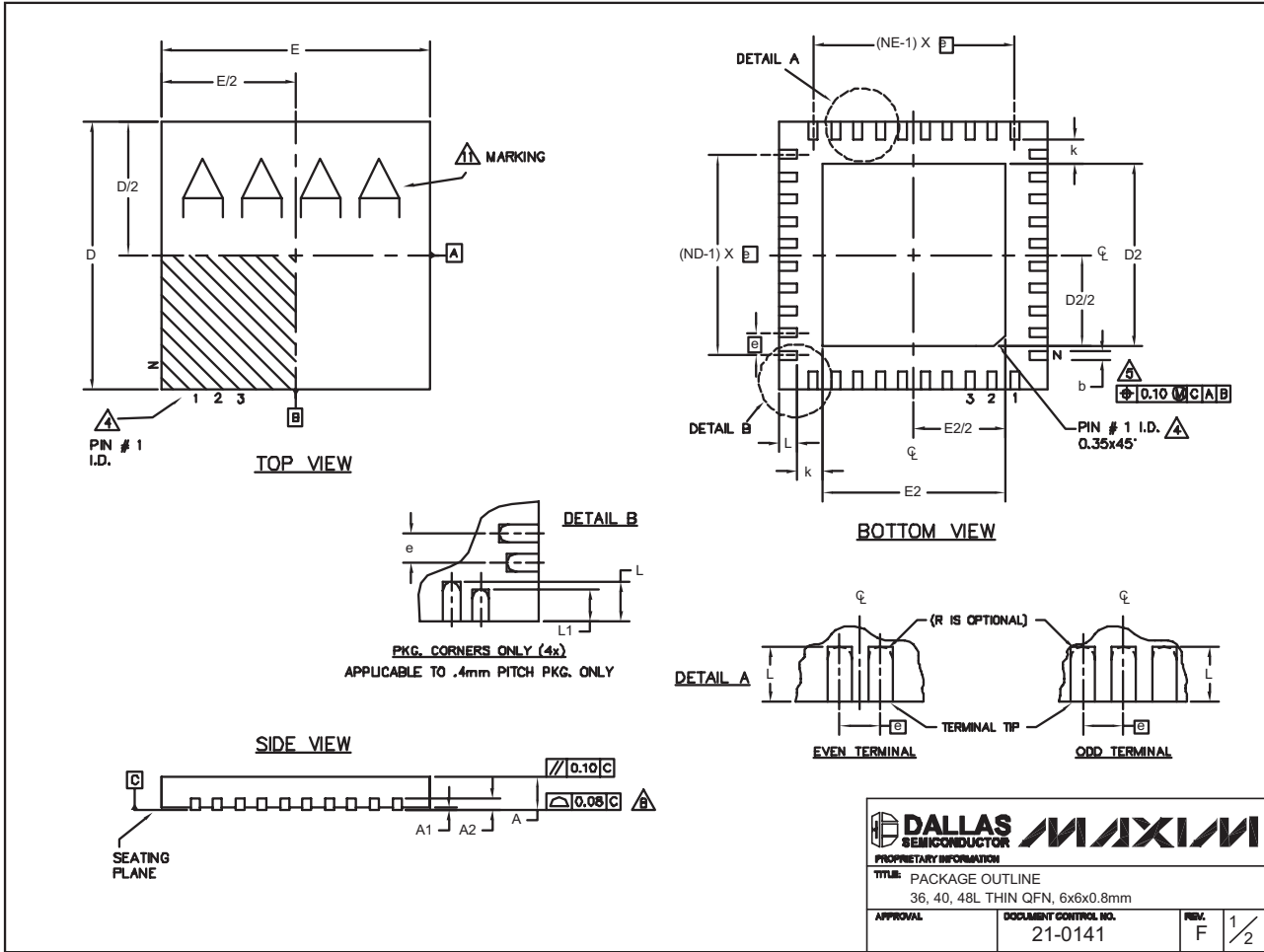

1700MHz to 3000MHz High-Linearity, Low LO Leakage Base-Station Rx/Tx Mixer

Package Information (continued)

(The package drawing(s) in this data sheet may not reflect the most current specifications. For the latest package outline information, go to www.maxim-ic.com/packages.)

MAX2043

COMMON DIMENSIONS									
PKG. SYMBOL	36L 6x6			40L 6x6			48L 6x6		
	MIN.	NOM.	MAX.	MIN.	NOM.	MAX.	MIN.	NOM.	MAX.
A	0.70	0.75	0.80	0.70	0.75	0.80	0.70	0.75	0.80
A1	0	0.02	0.05	0	0.02	0.05	0	—	0.05
A2	0.20 REF.			0.20 REF.			0.20 REF.		
b	0.20	0.25	0.30	0.20	0.25	0.30	0.15	0.20	0.25
D	5.90	6.00	6.10	5.90	6.00	6.10	5.90	6.00	6.10
E	5.90	6.00	6.10	5.90	6.00	6.10	5.90	6.00	6.10
e	0.50 BSC.			0.50 BSC.			0.40 BSC.		
k	0.25	—	—	0.25	—	—	0.25	0.35	0.45
L	0.45	0.55	0.65	0.30	0.40	0.50	0.40	0.50	0.60
L1	—	—	—	—	—	—	0.30	0.40	0.50
N	36			40			48		
ND	9			10			12		
NE	9			10			12		
JEDEC	WJJD-1			WJJD-2			—		

PKG. CODES	EXPOSED PAD VARIATIONS						DOWN BONDS ALLOWED
	DZ			EZ			
	MIN.	NOM.	MAX.	MIN.	NOM.	MAX.	
T3666-2	3.60	3.70	3.80	3.60	3.70	3.80	YES
T3666-3	3.60	3.70	3.80	3.60	3.70	3.80	NO
T3666N-1	3.60	3.70	3.80	3.60	3.70	3.80	NO
T4066-2	4.00	4.10	4.20	4.00	4.10	4.20	YES
T4066-3	4.00	4.10	4.20	4.00	4.10	4.20	YES
T4066-4	4.00	4.10	4.20	4.00	4.10	4.20	NO
T4066-5	4.00	4.10	4.20	4.00	4.10	4.20	NO
T4866-1	4.20	4.30	4.40	4.20	4.30	4.40	YES

NOTES:

- DIMENSIONING & TOLERANCING CONFORM TO ASME Y14.5M-1994.
- ALL DIMENSIONS ARE IN MILLIMETERS. ANGLES ARE IN DEGREES.
- N IS THE TOTAL NUMBER OF TERMINALS.
- THE TERMINAL #1 IDENTIFIER AND TERMINAL NUMBERING CONVENTION SHALL CONFORM TO JESD 95-1 SPP-012. DETAILS OF TERMINAL #1 IDENTIFIER ARE OPTIONAL, BUT MUST BE LOCATED WITHIN THE ZONE INDICATED. THE TERMINAL #1 IDENTIFIER MAY BE EITHER A MOLD OR MARKED FEATURE.
- DIMENSION b APPLIES TO METALLIZED TERMINAL AND IS MEASURED BETWEEN 0.25 mm AND 0.30 mm FROM TERMINAL TIP.
- ND AND NE REFER TO THE NUMBER OF TERMINALS ON EACH D AND E SIDE RESPECTIVELY.
- DEPOPULATION IS POSSIBLE IN A SYMMETRICAL FASHION.
- COPLANARITY APPLIES TO THE EXPOSED HEAT SINK SLUG AS WELL AS THE TERMINALS.
- DRAWING CONFORMS TO JEDEC MO220, EXCEPT FOR 0.4mm LEAD PITCH PACKAGE T4866-1.
- WARPAGE SHALL NOT EXCEED 0.10 mm.
- MARKING IS FOR PACKAGE ORIENTATION REFERENCE ONLY.
- NUMBER OF LEADS SHOWN FOR REFERENCE ONLY.

			
<small>PROPRIETARY INFORMATION</small>			
<small>TITLE: PACKAGE OUTLINE</small> <small>36, 40, 48L THIN QFN, 6x6x0.8mm</small>			
<small>APPROVAL</small> 	<small>DOCUMENT CONTROL NO.</small> 21-0141	<small>REV.</small> F	<small>2</small> / 2

Maxim cannot assume responsibility for use of any circuitry other than circuitry entirely embodied in a Maxim product. No circuit patent licenses are implied. Maxim reserves the right to change the circuitry and specifications without notice at any time.

Maxim Integrated Products, 120 San Gabriel Drive, Sunnyvale, CA 94086 408-737-7600

17