



Chipsmall Limited consists of a professional team with an average of over 10 year of expertise in the distribution of electronic components. Based in Hongkong, we have already established firm and mutual-benefit business relationships with customers from,Europe,America and south Asia,supplying obsolete and hard-to-find components to meet their specific needs.

With the principle of "Quality Parts,Customers Priority,Honest Operation,and Considerate Service",our business mainly focus on the distribution of electronic components. Line cards we deal with include Microchip,ALPS,ROHM,Xilinx,Pulse,ON,Everlight and Freescale. Main products comprise IC,Modules,Potentiometer,IC Socket,Relay,Connector.Our parts cover such applications as commercial,industrial, and automotives areas.

We are looking forward to setting up business relationship with you and hope to provide you with the best service and solution. Let us make a better world for our industry!



## Contact us

Tel: +86-755-8981 8866 Fax: +86-755-8427 6832

Email & Skype: info@chipsmall.com Web: www.chipsmall.com

Address: A1208, Overseas Decoration Building, #122 Zhenhua RD., Futian, Shenzhen, China



EVALUATION KIT  
AVAILABLE



## RMS Power Detector

MAX2203

### General Description

The MAX2203 RMS power detector is designed to operate from 800MHz to 2.0GHz. The device is ideal for wideband code-division multiple access (WCDMA), cdma2000®, and high-speed downlink/uplink packet access. The MAX2203 accepts an RF signal at the input and outputs the same voltage regardless of the peak-average of the input signal. The output voltage and input power is linear in dB. The device has a -24dBm to +3dBm detection range, and every dB change in input power gives 35mV (typ) change in output voltage.

The MAX2203 operates from a 2.5V to 4.2V supply and is specified over the -40°C to +85°C extended temperature range. The device is available in a 6-bump WLP package.

### Applications

WCDMA, cdma2000, 1xEVDO  
High-Speed Downlink Packet Access (HSDPA)  
High-Speed Uplink Packet Access (HSUPA)

*Typical Operating Circuit appears at end of data sheet.*

### Features

- ◆ -24dBm to +3dBm Power-Detection Range
- ◆ 35mV/dB (typ) Log Detector
- ◆ 0.1dB (typ) RMS Accuracy from WCDMA Modulation Change
- ◆ ±0.4dB Detection Error Due to Temperature
- ◆ +2.5V to +4.2V Single-Supply Operation
- ◆ Space-Saving 6-Bump WLP Package

### Ordering Information

PART	TEMP RANGE	PIN-PACKAGE	TOP MARK
MAX2203EWT+T10	-40°C to +85°C	6 WLP	AA

+Denotes a lead(Pb)-free/RoHS-compliant package.  
T = Tape and reel.

### Pin Configuration

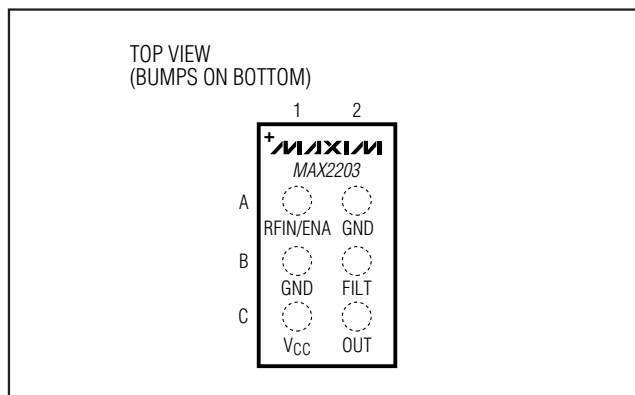

cdma2000 is a registered trademark of Telecommunications Industry Association.



Maxim Integrated Products 1

For pricing, delivery, and ordering information, please contact Maxim Direct at 1-888-629-4642, or visit Maxim's website at [www.maxim-ic.com](http://www.maxim-ic.com).

# RMS Power Detector

## ABSOLUTE MAXIMUM RATINGS

V <sub>CC</sub> to GND .....	-0.3V to +4.5V
ENA, OUT, FILT to GND .....	-0.3V to +3.0V
RFIN Input Power .....	+10dBm
Continuous Power Dissipation (T <sub>A</sub> = +70°C) 6-Bump WLP (derate 2.9mW/°C above +70°C).....	232mW

Junction-to-Ambient Thermal Resistance (θ <sub>JA</sub> ) (Note 1) .....	347°C/W
Operating Temperature Range .....	-40°C to +85°C
Storage Temperature Range .....	-65°C to +160°C
Junction Temperature .....	+150°C
Lead Temperature (soldering, 10s).....	Reflow Profile (Note 2)

**Note 1:** Package thermal resistances were obtained using the method described in JEDEC specifications. For detailed information on package thermal considerations, refer to [www.maxim-ic.com/thermal-tutorial](http://www.maxim-ic.com/thermal-tutorial).

**Note 2:** Refer to Application Note 1891: *Wafer-Level Packaging (WLP) and Its Applications*.

Stresses beyond those listed under "Absolute Maximum Ratings" may cause permanent damage to the device. These are stress ratings only, and functional operation of the device at these or any other conditions beyond those indicated in the operational sections of the specifications is not implied. Exposure to absolute maximum rating conditions for extended periods may affect device reliability.

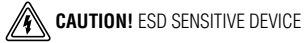

## DC ELECTRICAL CHARACTERISTICS

(V<sub>CC</sub> = 2.5V to 4.2V, T<sub>A</sub> = -40°C to +85°C, V<sub>ENA</sub> = 2.7V, no RF signal applied. Typical values are at V<sub>CC</sub> = 2.8V, T<sub>A</sub> = +25°C, unless otherwise noted.) (Note 3)

PARAMETER	SYMBOL	CONDITIONS	MIN	TYP	MAX	UNITS
Supply Voltage	V <sub>CC</sub>		2.5	2.8	4.2	V
Supply Current	I <sub>CC</sub>	V <sub>CC</sub> = 2.8V, RF input = -24dBm to +3dBm		5	8	mA
Shutdown Supply Current		V <sub>ENA</sub> = 0V		0.5	10	μA
ENA Logic-High Threshold	V <sub>IH</sub>		1.1		2.7	V
ENA Logic-Low Threshold	V <sub>IL</sub>		0		0.6	V
ENA Input Current		V <sub>ENA</sub> = 1.1V		25		μA

## AC ELECTRICAL CHARACTERISTICS

(V<sub>CC</sub> = 2.8V, T<sub>A</sub> = -40°C to +85°C, V<sub>ENA</sub> = 2.7V, f<sub>RF</sub> = 800MHz to 2GHz, unless otherwise noted. Typical values are at T<sub>A</sub> = +25°C.) (Note 3)

PARAMETER	SYMBOL	CONDITIONS	MIN	TYP	MAX	UNITS
RF Input Frequency			800		2000	MHz
Maximum Output Voltage		RFIN at +3dBm	1.05	1.5	1.75	V
Minimum Output Voltage		No RF input power		300	400	mV
Minimum Input Power Level		+1dB input power step results in at least 25mV increase in V <sub>OUT</sub> (Note 4)	-24			dBm
Log Slope		[(V <sub>OUT</sub> at +3dBm) - (V <sub>OUT</sub> at -24dBm)]/27	25	35	45	mV/dB
Log Conformance Error with 10dB Step		(Notes 4, 5)	-1.3		+1.3	dB
Power-Detector Accuracy Due to Temperature		RF input at -4dBm to 0dBm, T <sub>A</sub> = -40°C to +85°C, relative to +25°C		±0.4		dB

**Note 3:** Guaranteed by production test at T<sub>A</sub> = +85°C and 800MHz. Guaranteed by design and characterization at T<sub>A</sub> = -40°C and T<sub>A</sub> = +25°C, and over frequency limits.

**Note 4:** Guaranteed by design and characterization.

**Note 5:** Input power -24dBm to +3dBm. Ideal straight line calibrated with input power -20dBm and 0dBm at T<sub>A</sub> = +25°C.

# RMS Power Detector

MAX2203

## Typical Operating Characteristics

( $V_{CC} = 2.7V$ ,  $T_A = +25^\circ C$ , WCDMA uplink DPCCH + 1DPDCH, log conformance calculation is referenced to a straight line that is calibrated at -20dBm and 0dBm, unless otherwise noted.)

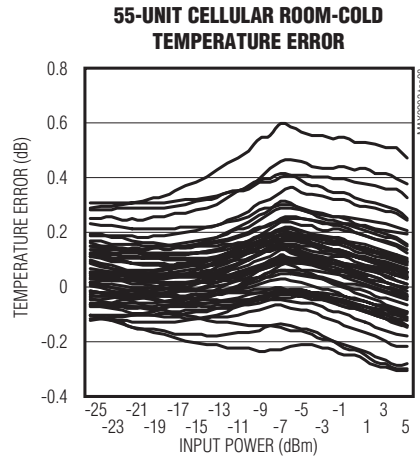
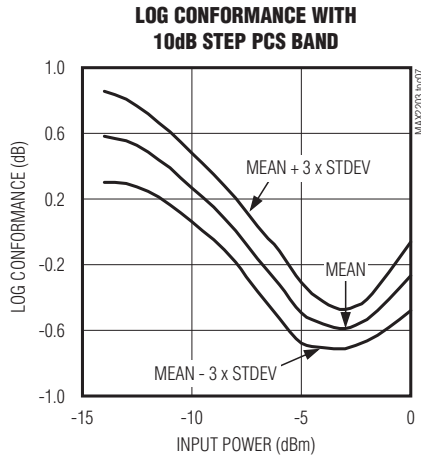
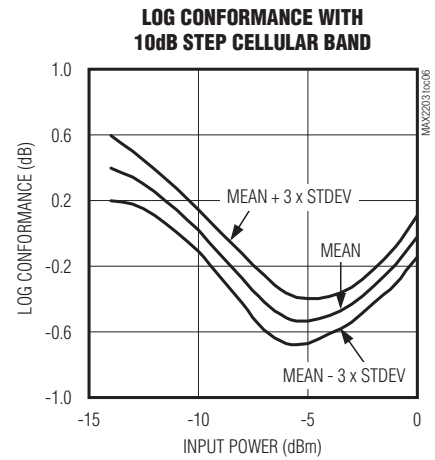
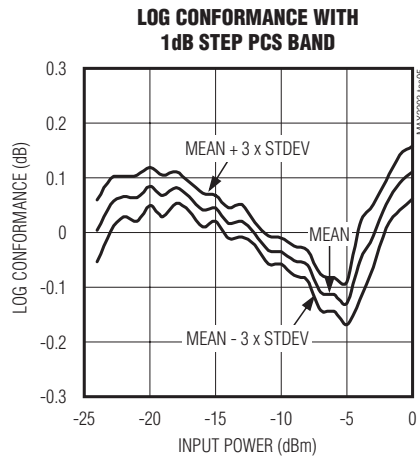
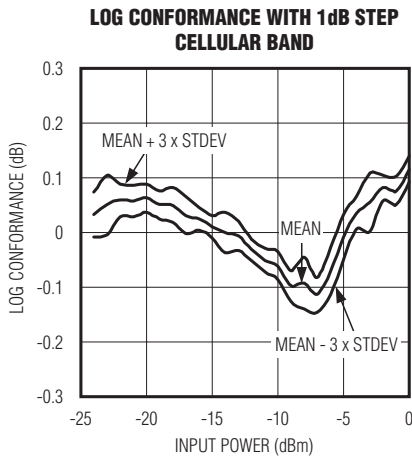
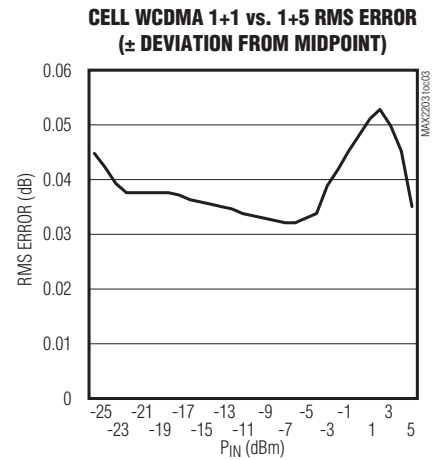
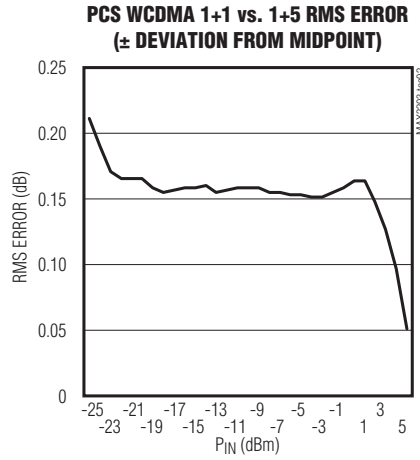
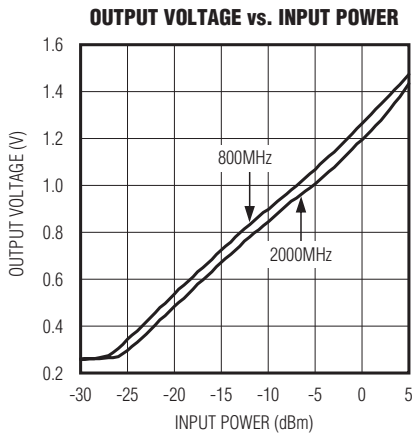

# RMS Power Detector

## Typical Operating Characteristics (continued)

( $V_{CC} = 2.7V$ ,  $T_A = +25^{\circ}C$ , WCDMA uplink DPCCH + 1DPDCH, log conformance calculation is referenced to a straight line that is calibrated at -20dBm and 0dBm, unless otherwise noted.)

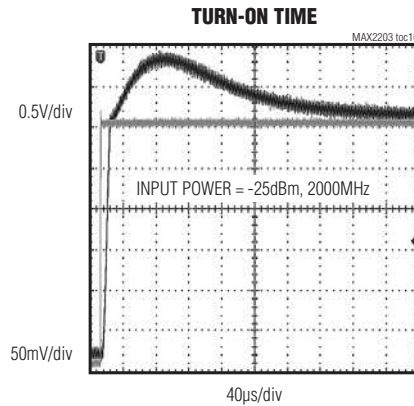
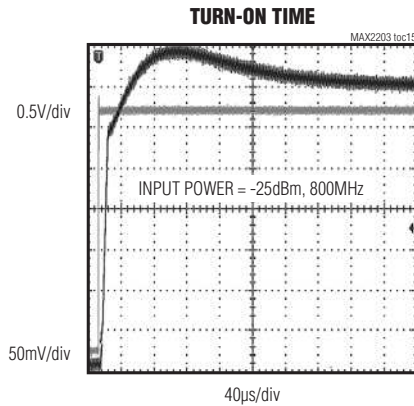
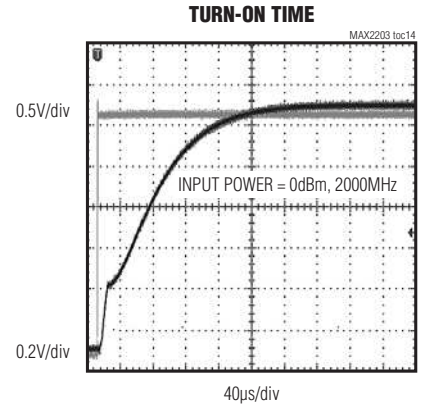
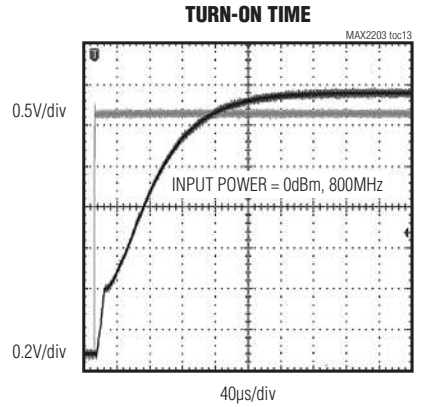
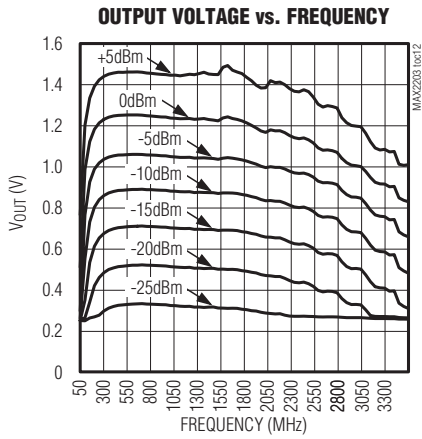
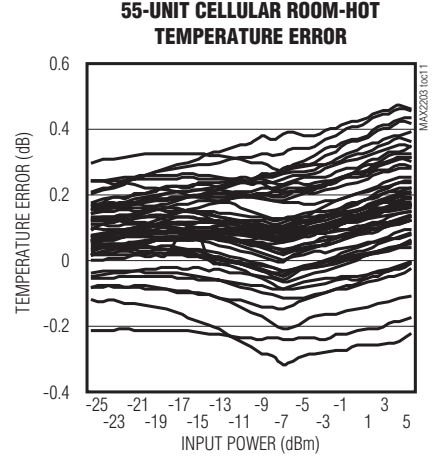
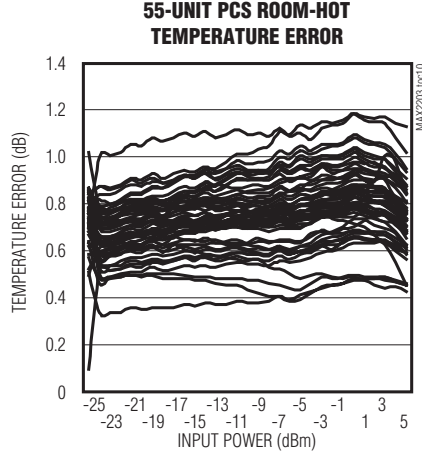
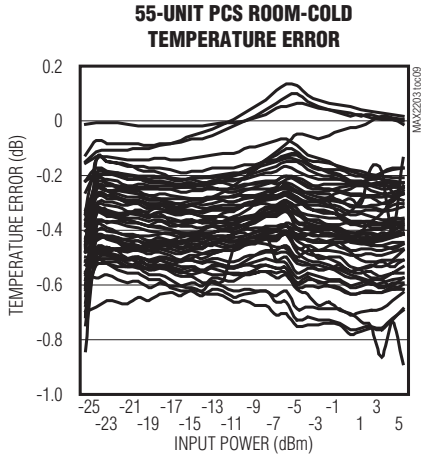

# RMS Power Detector

## Pin Description

MAX2203

BUMP	NAME	FUNCTION
A1	RFIN/ENA	RF Input and Enable Logic Input. See the <i>Typical Operating Circuit</i> . Drive ENA high to turn on the device. Drive ENA low to place it in shutdown mode.
A2, B1	GND	Ground. Connect to PCB ground plane.
B2	FILT	Intermediate Filtering Node. Bypass FILT with a capacitor as close as possible to the device.
C1	VCC	Power Supply. Connect to either a regulated supply or battery. Bypass VCC with a capacitor as close as possible to the device.
C2	OUT	Detector Output. Connect an external lowpass RC filter for filtering.

### Detailed Description

The MAX2203 RMS power detector is designed to operate from 800MHz to 2.0GHz. The device is ideal for WCDMA, cdma2000, and high-speed downlink/uplink packet access. The MAX2203 accepts an RF signal at the input and outputs the same voltage regardless of

the peak-average of the input signal. The output voltage and input power is linear in dB. The device has a -24dBm to +3dBm detection range, and every dB change in input power gives 35mV (typ) change in output voltage. Table 1 shows the peak to average of the signals used to test the MAX2203.

**Table 1. Peak-to-Average Ratio (PAR\*) of Test Signals**

MODULATION	PAR AT DIFFERENT PROBABILITY OF COMPLEMENTARY CUMULATIVE DISTRIBUTION (dB)			
	10%	1%	0.1%	0.01%
DPCCH + 1DPDCH	4.8	5.8	6.2	6.5
DPCCH + 5DPDCH	6.5	8.4	9.2	9.8
IS95 Reverse	5.5	6.9	7.6	8.1
IS95 Forward Pilot	5.6	7.6	8.8	9.5
9-Channel Forward	7	10.3	12	12.7
cdma2000 Pilot + DCCH	6.8	8.3	9.2	9.7

\*PAR of CW is 3dB.

# RMS Power Detector

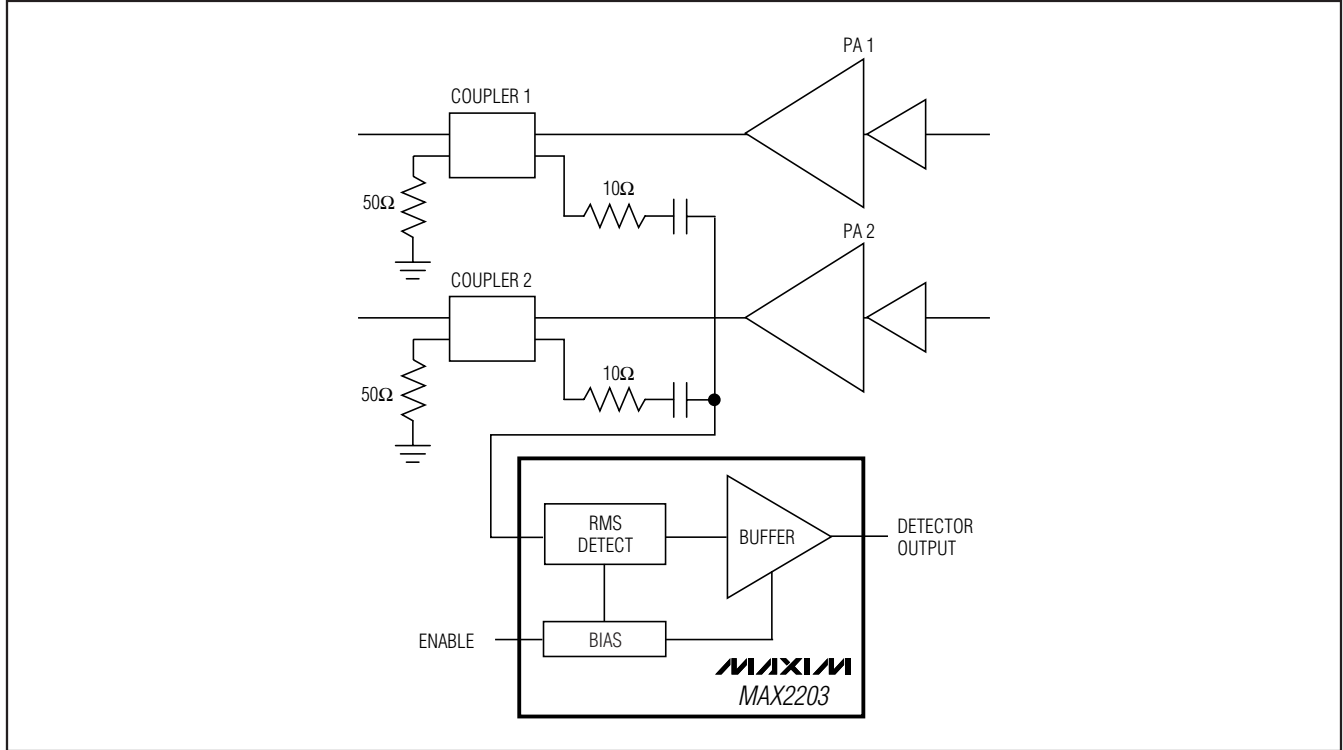

Figure 1. System Level Connection

## Applications Information

The MAX2203 uses external termination when using directional couplers. Figure 1 shows the system level connection of dual-band power detection. The output of the detector is typically connected to an ADC in cdma2000 or WCDMA power-control topology.

### Enable Logic Level

The MAX2203 features an enable input (ENA) that allows the device to be put into shutdown. For normal operation, drive ENA high. For device shutdown, drive ENA low. The ENA pin is DC biased through a resistor. The value of the resistor is recommended to be greater than 1kΩ to avoid loading the RF input signal. There is an internal resistor to GND of approximately 50kΩ. If the control source high voltage is greater than 2.8V, calculate and use a resistor value that ensures the ENA pin only sees a maximum of 2.7V, which is within specification. In this manner, the MAX2203 can be driven from a control device with a logic-high greater than 2.8V.

## Layout

The MAX2203 is not particularly sensitive to the layout since it only needs 3dBm for maximum output voltage. However, there are two areas that need attention: the GND pins and the supply bypassing. Connect the GND pins to the PCB ground with a ground via as close as possible, and bypass V<sub>CC</sub> to ground with a capacitor as close as possible to the part.

## Chip Information

PROCESS: BiCMOS

# RMS Power Detector

## Typical Operating Circuit

MAX2203

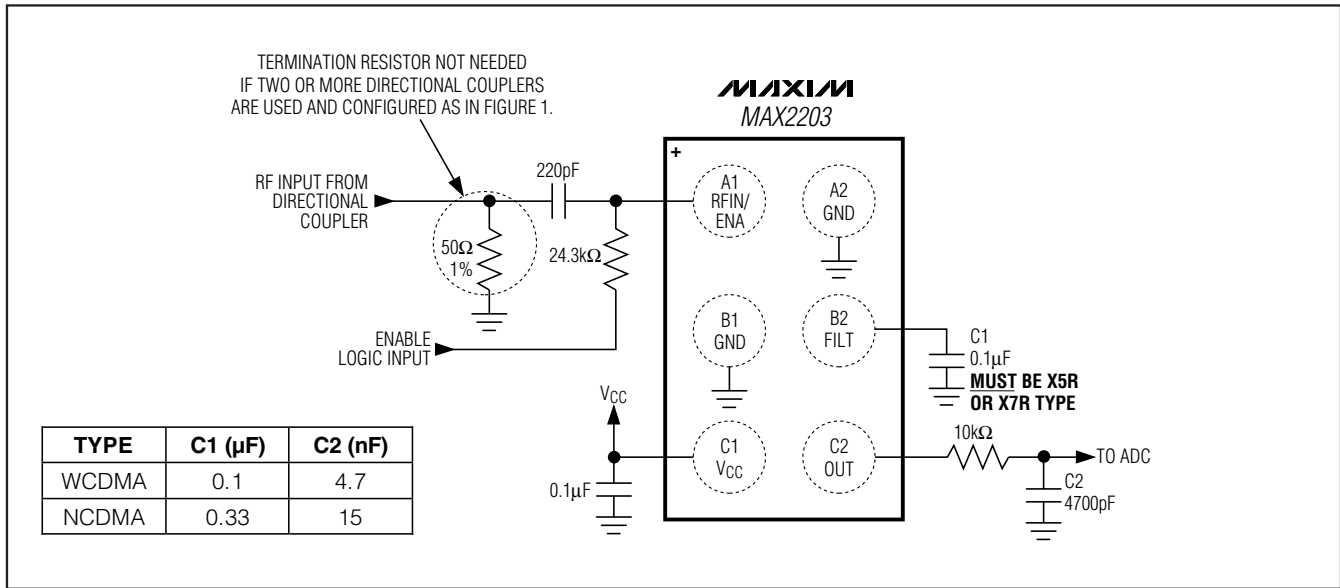

### Package Information

For the latest package outline information and land patterns, go to [www.maxim-ic.com/packages](http://www.maxim-ic.com/packages).

PACKAGE TYPE	PACKAGE CODE	DOCUMENT NO.
6 WLP	W61B1+1	<a href="#">21-0217</a>

Maxim cannot assume responsibility for use of any circuitry other than circuitry entirely embodied in a Maxim product. No circuit patent licenses are implied. Maxim reserves the right to change the circuitry and specifications without notice at any time.

Maxim Integrated Products, 120 San Gabriel Drive, Sunnyvale, CA 94086 408-737-7600 \_\_\_\_\_ 7