



Chipsmall Limited consists of a professional team with an average of over 10 year of expertise in the distribution of electronic components. Based in Hongkong, we have already established firm and mutual-benefit business relationships with customers from,Europe,America and south Asia,supplying obsolete and hard-to-find components to meet their specific needs.

With the principle of "Quality Parts,Customers Priority,Honest Operation,and Considerate Service",our business mainly focus on the distribution of electronic components. Line cards we deal with include Microchip,ALPS,ROHM,Xilinx,Pulse,ON,Everlight and Freescale. Main products comprise IC,Modules,Potentiometer,IC Socket,Relay,Connector.Our parts cover such applications as commercial,industrial, and automotives areas.

We are looking forward to setting up business relationship with you and hope to provide you with the best service and solution. Let us make a better world for our industry!



Contact us

Tel: +86-755-8981 8866 Fax: +86-755-8427 6832

Email & Skype: info@chipsmall.com Web: www.chipsmall.com

Address: A1208, Overseas Decoration Building, #122 Zhenhua RD., Futian, Shenzhen, China





Low-Voltage IF Transceiver with Limiter and RSSI

MAX2511

General Description

The MAX2511 is a complete, highly integrated IF transceiver for applications employing a dual-conversion architecture. Alternatively, the MAX2511 can be used as a single-conversion transceiver if the RF operating frequency ranges from 200MHz to 440MHz.

In a typical application, the receiver downconverts a high IF/RF (200MHz to 440MHz) to a 10.7MHz low IF using an image-reject mixer. Functions include an image-reject downconverter with 34dB of image suppression followed by an IF buffer that can drive an off-chip IF filter; an on-chip limiting amplifier offering 90dB of monotonic received-signal-strength indication (RSSI); and a robust limiter output driver. The transmit image-reject mixer generates a clean output spectrum to minimize filter requirements. It is followed by a 40dB variable-gain amplifier that maintains IM3 levels below -35dBc. Maximum output power is 2dBm. A VCO and oscillator buffer for driving an external prescaler are also included.

The MAX2511 operates from a 2.7V to 5.5V supply and includes flexible power-management control. Supply current is reduced to 0.1µA in shutdown mode.

For applications using in-phase (I) and quadrature (Q) baseband architecture for the transmitter, Maxim offers a corresponding transceiver product: the MAX2510. The MAX2510 has features similar to those of the MAX2511, but upconverts I/Q baseband signals using a quadrature upconverter.

Applications

PWT1900 Wireless Handsets and
Base Stations
PACS, PHS, DECT and Other PCS
Wireless Handsets and Base Stations
400MHz ISM Transceivers
IF Transceivers
Wireless Data Links

Typical Operating Circuit appears at end of data sheet.

Features

- ◆ Single +2.7V to +5.5V Supply
- ◆ Complete Receive Path:
200MHz to 440MHz (first IF) to
8MHz to 13MHz (second IF)
- ◆ Limiter with Differential Outputs (adjustable level)
- ◆ RSSI Function with 90dB Monotonic Dynamic Range
- ◆ Complete Transmit Path:
8MHz to 13MHz (second IF) to
200MHz to 440MHz (first IF)
- ◆ On-Chip Oscillator with Voltage Regulator
and Buffer
- ◆ Advanced System Power Management
(four modes)
- ◆ 0.1µA Shutdown Supply Current

Ordering Information

PART	TEMP. RANGE	PIN-PACKAGE
MAX2511EEI	-40°C to +85°C	28 QSOP

Pin Configuration

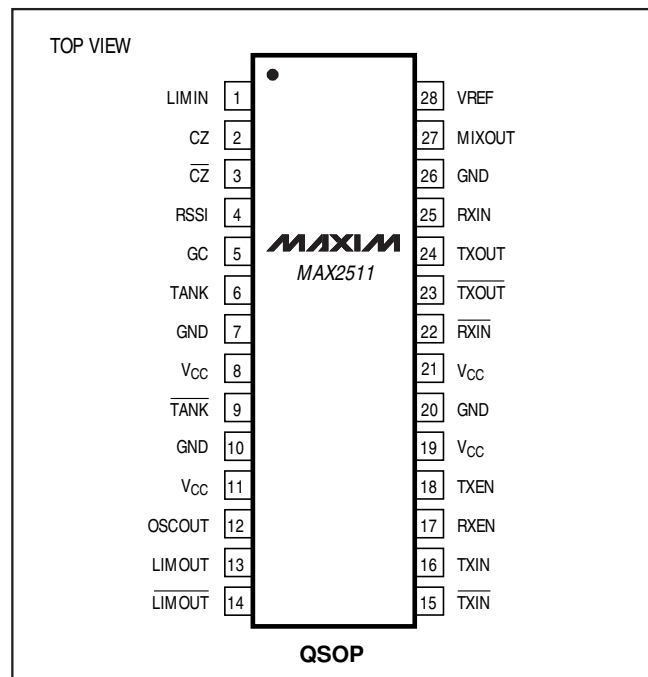

Low-Voltage IF Transceiver with Limiter and RSSI

ABSOLUTE MAXIMUM RATINGS

V_{CC} to GND-0.3V to 8.0V
 V_{CC} to Any Other V_{CC}±0.3V
 TXIN, $\overline{\text{TXIN}}$ Input Voltage.....-0.3V to (V_{CC} + 0.3V)
 TXIN to $\overline{\text{TXIN}}$ Differential Voltage±300mV
 RXIN, $\overline{\text{RXIN}}$ Input Voltage-0.3V to 1.6V
 TANK, $\overline{\text{TANK}}$ Voltage-0.3V to 2.0V
 LIMIN Voltage(VREF - 1.3V) to (VREF + 1.3V)
 LIMOUT, $\overline{\text{LIMOUT}}$ Voltage(V_{CC} - 1.6V) to (V_{CC} + 0.3V)
 RXEN, TXEN, GC Voltage.....-0.3V to (V_{CC} + 0.3V)

RXEN, TXEN, GC Input Current1mA
 RSSI Voltage.....-0.3V to (V_{CC} + 0.3V)
 Continuous Power Dissipation (T_A = +70°C)
 QSOP (derate 11mW/°C above 70°C)909mW
 Operating Temperature Range
 MAX2511EEI-40°C to +85°C
 Junction Temperature+150°C
 Storage Temperature Range-65°C to +165°C
 Lead Temperature (soldering, 10sec)+300°C

Stresses beyond those listed under "Absolute Maximum Ratings" may cause permanent damage to the device. These are stress ratings only, and functional operation of the device at these or any other conditions beyond those indicated in the operational sections of the specifications is not implied. Exposure to absolute maximum rating conditions for extended periods may affect device reliability.

DC ELECTRICAL CHARACTERISTICS

(V_{CC} = +2.7V to +5.5V, 0.01μF across CZ and $\overline{\text{CZ}}$; TANK = $\overline{\text{TANK}}$; MIXOUT tied to VREF through a 165Ω resistor; GC open, RXIN = $\overline{\text{RXIN}}$; TXOUT = $\overline{\text{TXOUT}}$ = V_{CC}; T_A = -40°C to +85°C, unless otherwise noted. Typical values are at T_A = +25°C.)

PARAMETER	CONDITIONS		MIN	TYP	MAX	UNITS
Operating Voltage Range			2.7	3.0	5.5	V
Digital Input Voltage High	RXEN, TXEN		2.0			V
Digital Input Voltage Low	RXEN, TXEN				0.4	V
Digital Input Current High				23	32	μA
Digital Input Current Low			-5	-1		μA
Typical Supply Current	V _{CC} = 3.0V T _A = +25°C	Rx mode, RXEN = high, TXEN = low		24		mA
		Tx mode, RXEN = low, TXEN = high, V _{GC} = 0.5V		26		
		Standby mode, RXEN = high, TXEN = high		9.5		
		Shutdown mode, RXEN = low, TXEN = low		0.1		μA
Worst-Case Supply Current	V _{CC} = 2.7V to 5.5V, T _A = -40°C to +85°C	Rx mode, RXEN = high, TXEN = low			38.5	mA
		Tx mode, RXEN = low, TXEN = high, V _{GC} = 0.5V			45	
		Standby mode, RXEN = high, TXEN = high			14.5	
		Shutdown mode, RXEN = low, TXEN = low			5	μA
VREF Voltage	(Note 1)		$V_{CC}/2 - 100\text{mV}$	$V_{CC}/2$	$V_{CC}/2 + 100\text{mV}$	V
LIMOUT, $\overline{\text{LIMOUT}}$ Differential Output Impedance				2		kΩ
GC Input Resistance	Internally terminated to 1.35V		60	80	125	kΩ

Low-Voltage IF Transceiver with Limiter and RSSI

MAX2511

AC ELECTRICAL CHARACTERISTICS

(MAX2511 test fixture, $V_{CC} = +3.0V$, $R_{XEN} = TXEN = \text{low}$, $0.01\mu F$ across CZ and \overline{CZ} , MIXOUT tied to VREF through 165Ω resistor, $TXIN, \overline{TXIN}$ tied to VREF through 50Ω resistor, TXOUT and \overline{TXOUT} loaded with 100Ω differential, GC open, LIMOUT, \overline{LIMOUT} loaded with $2k\Omega$ differential, TANK and \overline{TANK} driven with $-2.5dBm$ from a 100Ω source; OSCOUT AC-terminated with 50Ω , $330pF$ at RSSI pin, $0.1\mu F$ at VREF pin, Rx inputs and Tx outputs differentially coupled, $PR_{XIN}, \overline{RXIN} = -28dBm$ (200Ω system), $f_{RXIN}, \overline{RXIN} = 425MHz$, $f_{LO} = 435.7MHz$, $f_{TXIN}, \overline{TXIN} = 10.7MHz$, $T_A = +25^\circ C$, unless otherwise noted.)

PARAMETER	CONDITIONS	MIN	TYP	MAX	UNITS
DOWNCONVERTER ($R_{XEN} = \text{high}$)					
Downconverter Mixer Voltage Gain	$T_A = +25^\circ C$	21.5	23.6	25.5	dB
	$T_A = -40^\circ C$ to $+85^\circ C$ (Note 1)	20		27	
Downconverter Mixer Noise Figure			14		dB
Downconverter Mixer Input 1dB Compression Level	(Note 2)		-16		dBm
Input Third-Order Intercept	Two tones at 424MHz and 425MHz, $-30dBm$ per tone		-11		dBm
Image Rejection	$f_{IMAGE} = f_{LO} + f_{IF} = 446.4MHz$	25	34		dB
MIXOUT Maximum Voltage Swing			2		Vp-p
Power-Up Time	Standby to RX or TX (Note 3)			5	μs
LIMITING AMPLIFIER AND RSSI ($R_{XEN} = \text{high}$)					
Limiter Output Level	$V_{GC} = 0.8V$ (Note 4)		120	160	mVp-p
	$V_{GC} = \text{open}$	475		625	
	$V_{GC} = 2.0V$ ($PL_{MIN} = +5dBm$)	950	1100		
Phase Variation	$-75dBm$ to $5dBm$ from 50Ω		3.6		degrees
Minimum Linear RSSI Range	$-75dBm$ to $5dBm$ from 50Ω		80		dB
Minimum Monotonic RSSI Range	$-80dBm$ to $10dBm$ from 50Ω		90		dB
RSSI Slope	$-75dBm$ to $5dBm$ from 50Ω		10.6		mV/dB
RSSI Maximum Intercept	(Note 5)		-82	-75	dBm
RSSI Relative Error	$T_A = +25^\circ C$		± 1	± 2	dB
	$T_A = -40^\circ C$ to $+85^\circ C$ (Note 1)			± 2.5	
RSSI Rise Time	Rise time to within 1dB accuracy; using a $100pF$ capacitor from RSSI to GND		6.4		μs
Minimum-Scale RSSI Voltage	At LIMIN input of $-75dBm$	50	90	135	mV
Maximum-Scale RSSI Voltage	At LIMIN input of $5dBm$	850	940	1025	mV
OSCILLATOR ($TXEN = RXEN = \text{high}$)					
Frequency Range	(Note 7)	200		440	MHz
Phase Noise	At 10kHz offset		-88		dBc/Hz
Maximum LO Frequency Pulling	Standby mode to TX or RX mode		± 36		kHz
LO Leakage	At RXIN port		-65		dBm
Oscillator Buffer Output Power	$T_A = +25^\circ C$ (Note 8)	-12	-9		dBm
	$T_A = -40^\circ C$ to $+85^\circ C$ (Notes 1 and 8)	-13			
Maximum Power-Up Time	Shutdown to standby mode (Note 9)		220		μs

Low-Voltage IF Transceiver with Limiter and RSSI

AC ELECTRICAL CHARACTERISTICS (continued)

(MAX2511 test fixture, $V_{CC} = +3.0V$, $R_{XEN} = TXEN = \text{low}$, $0.01\mu F$ across CZ and \overline{CZ} , MIXOUT tied to VREF through 165Ω resistor, TXIN, \overline{TXIN} tied to VREF through 50Ω resistor, TXOUT and \overline{TXOUT} loaded with 100Ω differential, GC open, LIMOUT, \overline{LIMOUT} loaded with $2k\Omega$ differential, TANK and \overline{TANK} driven with $-2.5dBm$ from a 100Ω source; OSCOUT AC-terminated with 50Ω , $330pF$ at RSSI pin, $0.1\mu F$ at VREF pin, Rx inputs and Tx outputs differentially coupled, PR_{XIN} , $\overline{RXIN} = -28dBm$ (200Ω system), f_{RXIN} , $\overline{RXIN} = 425MHz$, $f_{LO} = 435.7MHz$, f_{TXIN} , $\overline{TXIN} = 10.7MHz$, $T_A = +25^\circ C$, unless otherwise noted.)

PARAMETER	CONDITIONS	MIN	TYP	MAX	UNITS
TRANSMITTER (TXEN = high, V_{TXIN} and $\overline{V_{TXIN}} = 100mVp-p$ differential)					
Output Power	$V_{GC} = 0.5V$, $T_A = +25^\circ C$		-44		dBm
	$V_{GC} = \text{open}$, $T_A = +25^\circ C$		-19		
	$V_{GC} = 2.0V$, $T_A = +25^\circ C$	-5	-2		
	$V_{GC} = 2.0V$, $T_A = -40^\circ C$ to $+85^\circ C$ (Note 1)	-6			
Image Rejection			34	25	dBc
LO Rejection			40	30	dBc
Output 1dB Compression Point	$V_{GC} = 2.0V$		2		dBm
Output IM3 Level	$0.5V < V_{GC} < 1.87V$ $-40dBm < P_{OUT} < -10dBm$ (Note 10)		-40		dBc
	$V_{GC} = 2.0V$		-35		

Note 1: Guaranteed by design and characterization.

Note 2: Driving RXIN or \overline{RXIN} with a power level greater than the 1dB compression level forces the input stage out of its linear range, causing harmonic and intermodulation distortion. The RSSI output increases monotonically with increasing input levels beyond the mixer's 1dB compression level.

Note 3: Assuming the supply voltage has been applied, this includes settling of the limiter offset correction and the Rx or Tx bias stabilization time. Guaranteed by design.

Note 4: LIMOUT, \overline{LIMOUT} loaded with $2k\Omega$ differential. With no load, the output swing is approximately twice as large.

Note 5: The RSSI maximum intercept is the maximum input power (over a statistical sample of parts) at which the RSSI output is 0V. This point is extrapolated from the linear portion of the RSSI voltage versus limiter input power. This specification and the RSSI slope define the ideal behavior of the RSSI function (the slope and intercept of a straight line), while the RSSI relative error specification defines the deviations from this line. See the RSSI Output Voltage vs. Limiter Input Power graph in the *Typical Operating Characteristics*.

Note 6: The RSSI relative error is the deviation from the best-fitting straight line of RSSI output voltage versus limiter input power. A 0dB relative error is exactly on this line. The limiter input power range for this test is $-75dBm$ to $+5dBm$ from 50Ω . See the RSSI Relative Error graph in the *Typical Operating Characteristics*.

Note 7: Operation outside this frequency range is possible but has not been characterized. At lower frequencies, it might be necessary to overdrive the oscillator with an external signal source.

Note 8: If a larger output level is required, a higher value of load resistance (up to 100Ω) may be used.

Note 9: This assumes that the supply voltage has been applied, and includes the settling time of VREF, using the *Typical Operating Circuit*.

Note 10: Using two tones at 10.7MHz and 10.8MHz, 50mVp-p per tone at TXIN, \overline{TXIN} . See *Typical Operating Characteristics*.

Low-Voltage IF Transceiver with Limiter and RSSI

MAX2511

Typical Operating Characteristics

(MAX2511 test fixture, $V_{CC} = +3.0V$, $0.01\mu F$ across CZ and \overline{CZ} , MIXOUT tied to VREF through 165Ω resistor, TXIN, \overline{TXIN} tied to VREF through 50Ω resistor, TXOUT and \overline{TXOUT} loaded with 100Ω differential, GC open, LIMOUT, \overline{LIMOUT} loaded with $2k\Omega$ differential, TANK and \overline{TANK} driven with $-2.5dBm$ from a 100Ω source; OSCOUT AC-terminated with 50Ω , $100pF$ at RSSI pin, $0.1\mu F$ at VREF pin, Rx inputs and Tx outputs differentially coupled, $P_{RXIN}, \overline{RXIN} = -28dBm$ (200 Ω system), $f_{RXIN}, \overline{RXIN} = 425MHz$, $f_{LO} = 435.7MHz$, $f_{TXIN}, \overline{TXIN} = 10.7MHz$, $T_A = +25^\circ C$, unless otherwise noted.)

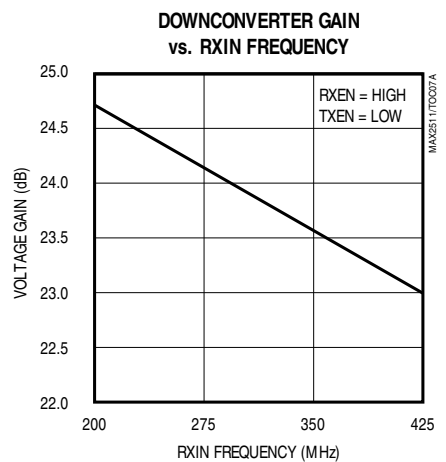
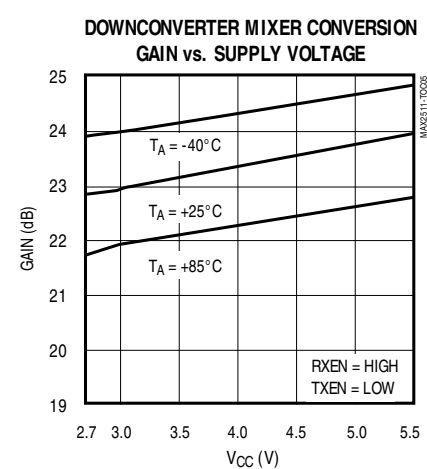
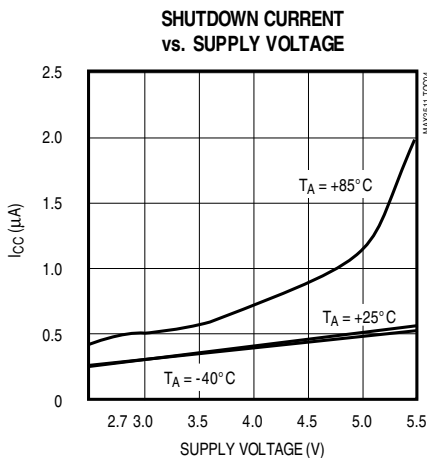
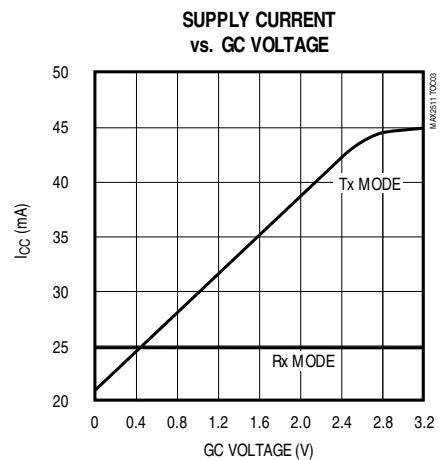
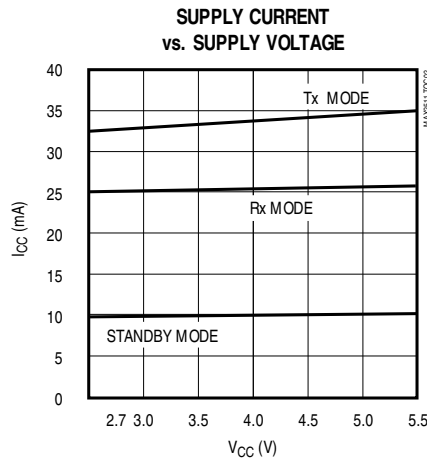
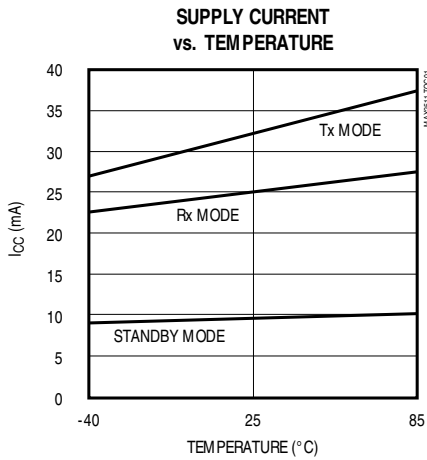

Low-Voltage IF Transceiver with Limiter and RSSI

Typical Operating Characteristics (continued)

(MAX2511 test fixture, $V_{CC} = +3.0V$, $0.01\mu F$ across CZ and \overline{CZ} , MIXOUT tied to VREF through 165Ω resistor, TXIN, \overline{TXIN} tied to VREF through 50Ω resistor, TXOUT and \overline{TXOUT} loaded with 100Ω differential, GC open, LIMOUT, \overline{LIMOUT} loaded with $2k\Omega$ differential, TANK and \overline{TANK} driven with $-2.5dBm$ from a 100Ω source; OSCOUT AC-terminated with 50Ω , $100pF$ at RSSI pin, $0.1\mu F$ at VREF pin, Rx inputs and Tx outputs differentially coupled, $P_{RXIN}, \overline{RXIN} = -28dBm$ (200Ω system), $f_{RXIN}, \overline{RXIN} = 425MHz$, $f_{LO} = 435.7MHz$, $f_{TXIN}, \overline{TXIN} = 10.7MHz$, $T_A = +25^\circ C$, unless otherwise noted.)

DOWNCONVERTER IMAGE REJECTION vs. RXIN FREQUENCY

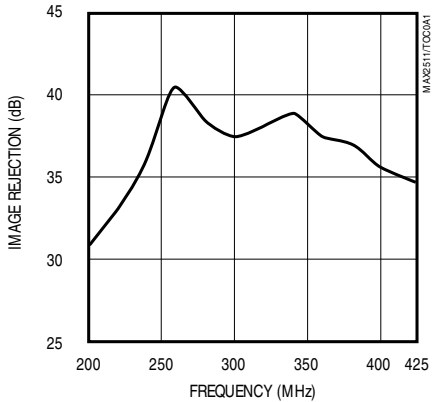

DOWNCONVERTER-MIXER IMAGE REJECTION vs. TEMPERATURE AND SUPPLY VOLTAGE

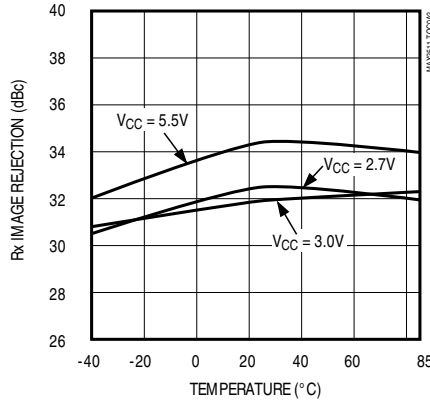

DOWNCONVERTER IMAGE REJECTION vs. IF FREQUENCY

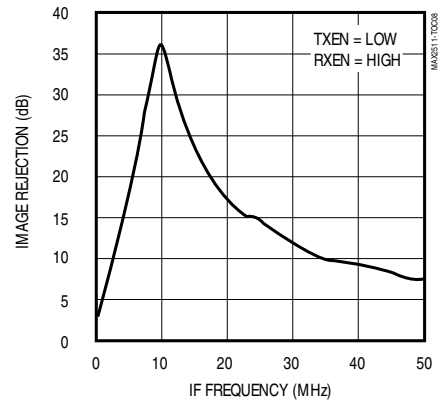

DOWNCONVERTER INPUT 1dB COMPRESSION LEVEL

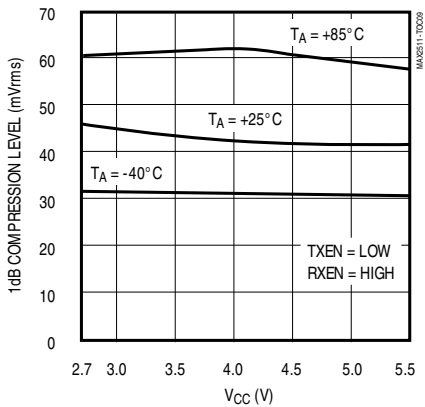

RXIN DIFFERENTIAL INPUT IMPEDANCE vs. FREQUENCY

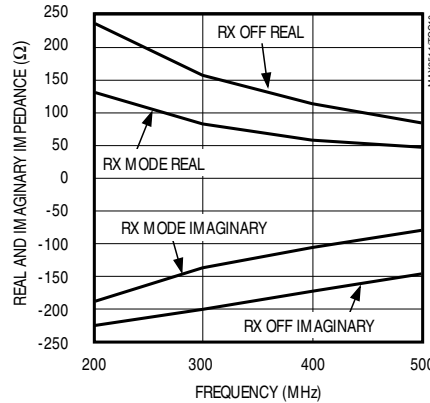

LIMITER OUTPUT LEVEL vs. GC VOLTAGE

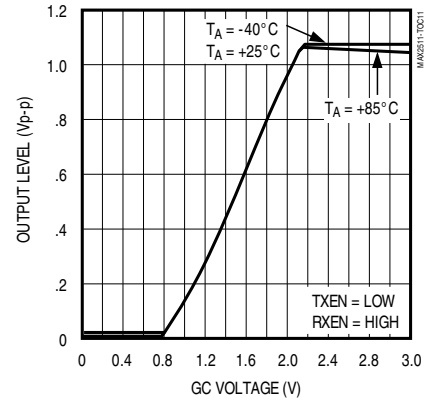

Low-Voltage IF Transceiver with Limiter and RSSI

MAX2511

Typical Operating Characteristics (continued)

(MAX2511 test fixture, $V_{CC} = +3.0V$, $0.01\mu F$ across CZ and \overline{CZ} , MIXOUT tied to VREF through 165Ω resistor, TXIN, \overline{TXIN} tied to VREF through 50Ω resistor, TXOUT and \overline{TXOUT} loaded with 100Ω differential, GC open, LIMOUT, \overline{LIMOUT} loaded with $2k\Omega$ differential, TANK and \overline{TANK} driven with $-2.5dBm$ from a 100Ω source; OSCOUT AC-terminated with 50Ω , $100pF$ at RSSI pin, $0.1\mu F$ at VREF pin, Rx inputs and Tx outputs differentially coupled, P_{RXIN} , $\overline{RXIN} = -28dBm$ (200Ω system), f_{RXIN} , $\overline{RXIN} = 425MHz$, $f_{LO} = 435.7MHz$, f_{TXIN} , $\overline{TXIN} = 10.7MHz$, $T_A = +25^\circ C$, unless otherwise noted.)

TRANSMITTER OUTPUT POWER vs. GC VOLTAGE (FREQUENCY)

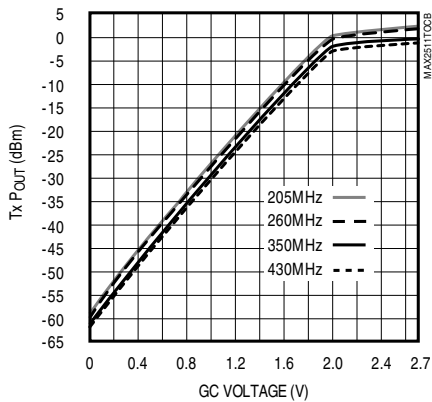

TRANSMITTER DIFFERENTIAL OUTPUT IMPEDANCE vs. FREQUENCY

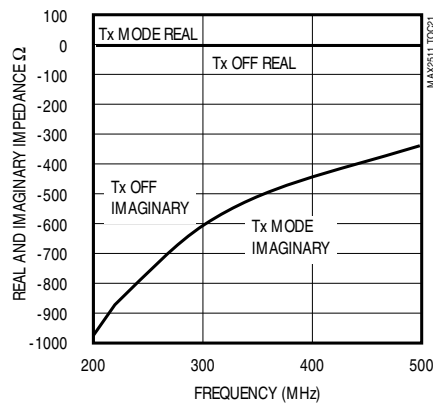

UPCONVERTER IM3 LEVELS vs. GC VOLTAGE (POWERS ARE PER TONE)

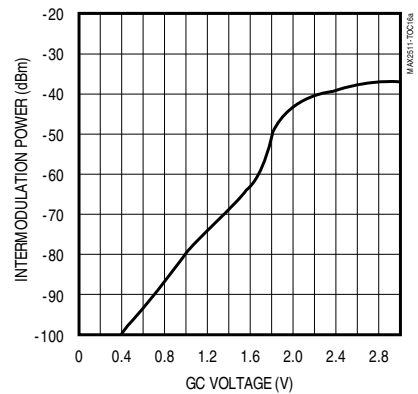

TRANSMITTER OUTPUT POWER vs. TEMPERATURE, SUPPLY, AND GC VOLTAGE

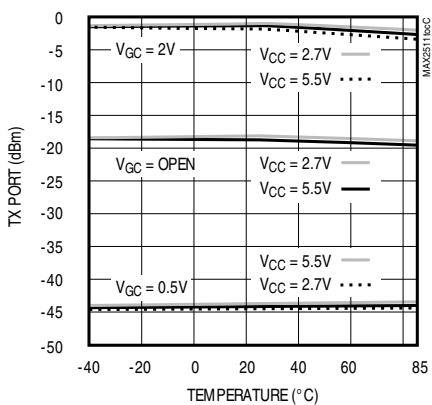

TRANSMITTER OUTPUT POWER vs. TEMPERATURE AND SUPPLY GC VOLTAGE (GC = 2V)

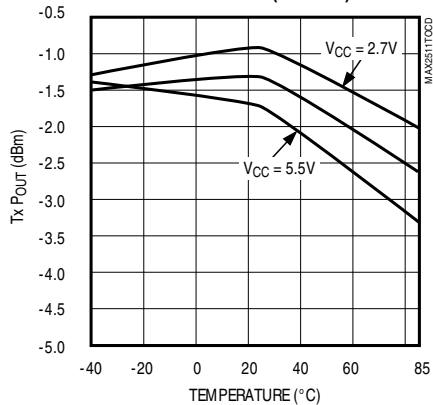

UPCONVERTER IMAGE REJECTION vs. IF FREQUENCY

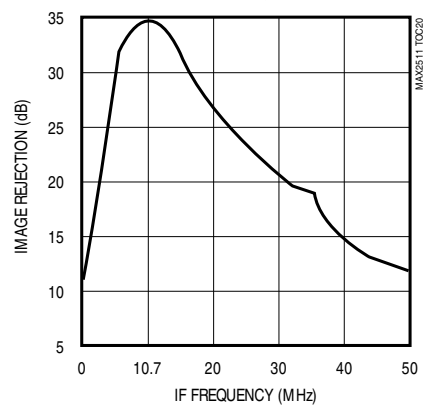

Low-Voltage IF Transceiver with Limiter and RSSI

Typical Operating Characteristics (continued)

(MAX2511 test fixture, $V_{CC} = +3.0V$, $0.01\mu F$ across CZ and \overline{CZ} , MIXOUT tied to VREF through 165Ω resistor, TXIN, \overline{TXIN} tied to VREF through 50Ω resistor, TXOUT and \overline{TXOUT} loaded with 100Ω differential, GC open, LIMOUT, \overline{LIMOUT} loaded with $2k\Omega$ differential, TANK and \overline{TANK} driven with $-2.5dBm$ from a 100Ω source; OSCOUT AC-terminated with 50Ω , $100pF$ at RSSI pin, $0.1\mu F$ at VREF pin, Rx inputs and Tx outputs differentially coupled, P_{RXIN} , $\overline{RXIN} = -28dBm$ (200Ω system), f_{RXIN} , $\overline{RXIN} = 425MHz$, $f_{LO} = 435.7MHz$, f_{TXIN} , $\overline{TXIN} = 10.7MHz$, $T_A = +25^\circ C$, unless otherwise noted.)

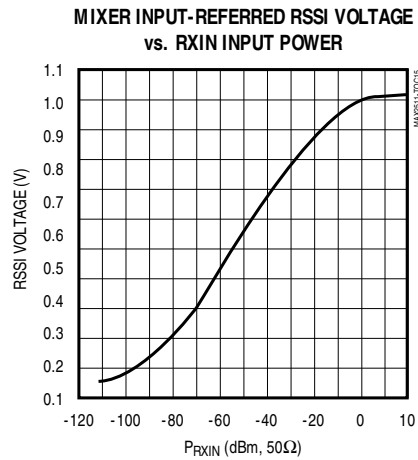
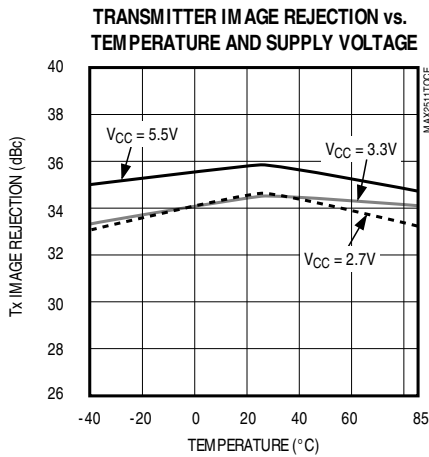
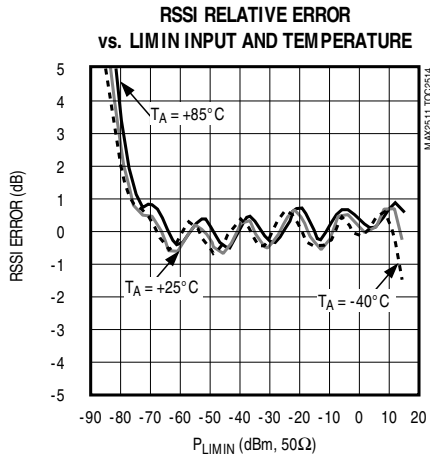
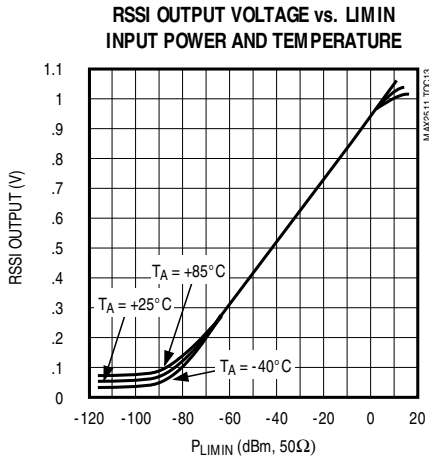

Low-Voltage IF Transceiver with Limiter and RSSI

Pin Description

MAX2511

PIN	NAME	FUNCTION
1	LIMIN	Limiter Input. Connect a 330Ω (typ) resistor to VREF for DC bias, as shown in the <i>Typical Operating Circuit</i> .
2, 3	CZ, \overline{CZ}	Offset-Correction Capacitor pins. Connect a 0.01μF capacitor between CZ and \overline{CZ} .
4	RSSI	Receive-Signal-Strength-Indicator Output. The voltage on RSSI is proportional to the signal power at LIMIN. The RSSI output sources current pulses into an external capacitor (100pF typ). The output is internally terminated with 6kΩ, and this RC time constant sets the decay time.
5	GC	Gain-Control pin in transmit mode. Applying a DC voltage to GC between 0V and 2.0V adjusts the transmitter gain by 40dB. In receive mode, GC adjusts the limiter output level from 0Vp-p to about 1Vp-p. This pin's input impedance is typically 80kΩ terminated to 1.35V.
6, 9	TANK, \overline{TANK}	Tank pins. Connect the resonant tank across these pins, as shown in the <i>Typical Operating Circuit</i> .
7, 10	GND	Ground. Connect GND to the PC board ground plane with minimal inductance.
8, 11	VCC	Supply Voltage. Bypass VCC directly to GND. See the <i>Layout Issues</i> section.
12	OSCOUT	Oscillator-Buffer Output. OSCOUT provides a buffered oscillator signal (at the oscillator frequency) for driving an external prescaler. This pin is a current output and must be AC-coupled to a resistive load. The output power is typically -9dBm into a 50Ω load. If a larger output swing is required, a larger load resistance (up to 100Ω) can be used.
13, 14	LIMOUT, \overline{LIMOUT}	Differential Outputs of the Limiting Amplifier. LIMOUT and \overline{LIMOUT} are open-collector outputs that are internally pulled up to VCC through 1kΩ resistors.
15, 16	\overline{TXIN} , TXIN	Differential Inputs of the Image-Reject Upconverter Mixer. \overline{TXIN} and TXIN are high impedance and must be pulled up to VCC through two external resistors whose value is equal to the desired terminating impedance (50Ω to 50kΩ).
17	RXEN	Receiver-Enable pin. When high, RXEN enables the receiver if TXEN is low. If both RXEN and TXEN are high, the part is in standby mode; if both are low, the part is in shutdown. See the <i>Power Management</i> section for more details.
18	TXEN	Transmitter-Enable pin. When high, TXEN enables the transmitter, if RXEN is low. If both TXEN and RXEN are high, the part is in standby mode; if both are low, the part is in shutdown. See the <i>Power Management</i> section for more details.
19, 21	VCC	Bias VCC Supply pins. Decouple these pins to GND. See the <i>Layout Issues</i> section.
20	GND	Receiver/Transmitter Ground pin. Connect to the PC board ground plane with minimal inductance.
22, 25	\overline{RXIN} , RXIN	Differential Inputs of the Image-Reject Downconverter Mixer. In most applications, an impedance matching network is required. See the <i>Applications Information</i> section for more details.
23, 24	\overline{TXOUT} , TXOUT	Differential Outputs of the Image-Reject Upconverter. \overline{TXOUT} and TXOUT must be pulled up to VCC with two external inductors and AC coupled to the load.
26	GND	Receiver Front-End Ground. Connect GND to the PC board ground plane with minimal inductance.
27	MIXOUT	Single-Ended Output of the Image-Reject Downconverter. MIXOUT is high impedance and must be biased to the VREF pin through an external terminating resistor whose value depends on the inter-stage filter characteristics. See the <i>Applications Information</i> section for more details.
28	VREF	Reference Voltage pin. VREF is used to provide an external bias voltage for the MIXOUT and LIMIN pins. Bypass this pin with a 0.1μF capacitor to ground. VREF voltage is equal to VCC / 2. See the <i>Typical Operating Circuit</i> for more information.

Low-Voltage IF Transceiver with Limiter and RSSI

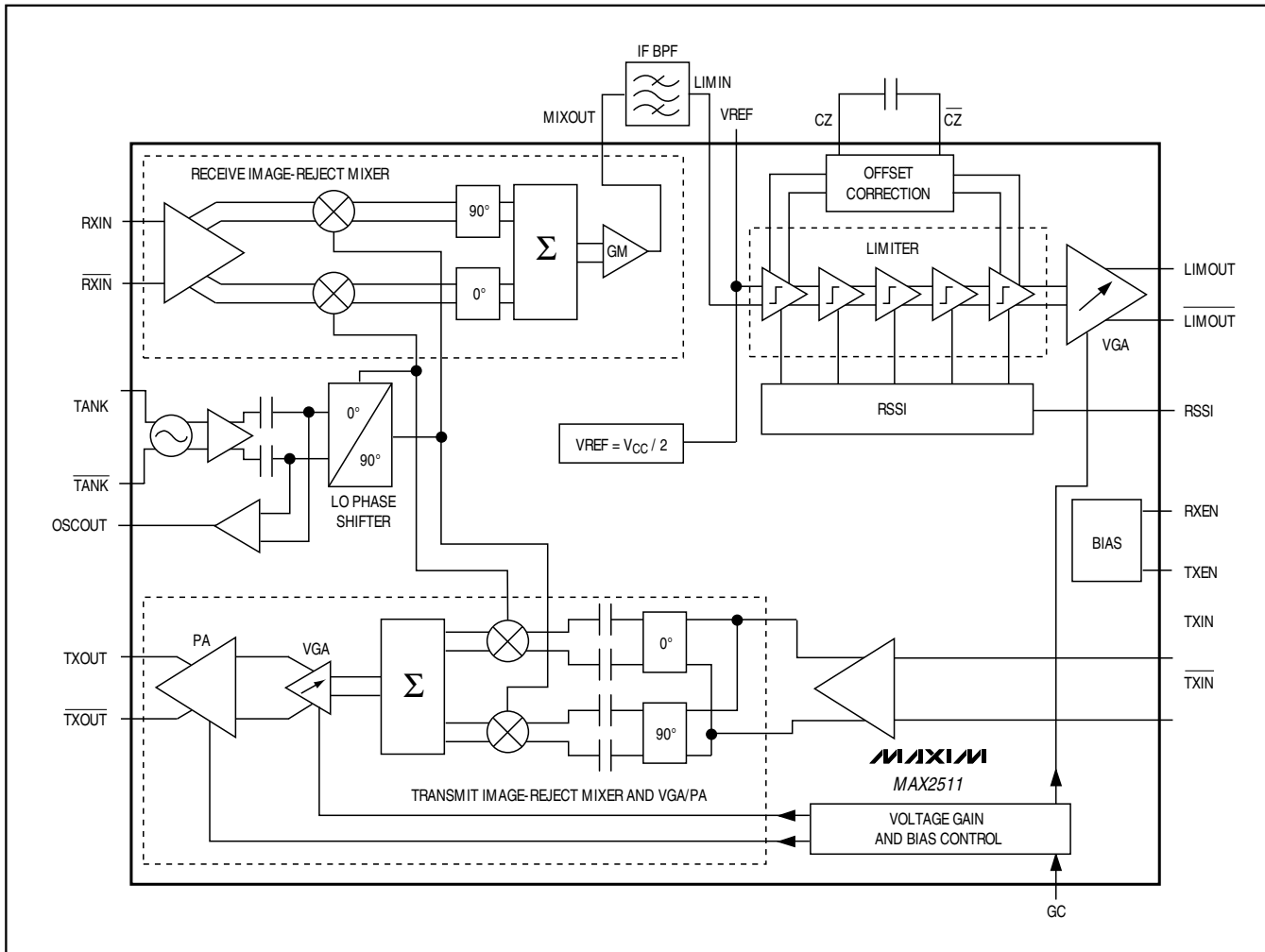

Figure 1. Functional Diagram

Detailed Description

The following sections describe each of the blocks shown in Figure 1.

Receiver

The receiver consists of two basic blocks: the image-reject downconverter mixer and the limiter/RSSI section.

The receiver inputs are the RXIN, $\overline{\text{RXIN}}$ pins, which should be AC coupled and may require a matching network, as shown in the *Typical Operating Circuit*. To design a matching network for a particular application, refer to the *Applications Information* section and the receiver input impedance plots in the *Typical Operating Characteristics*.

Image-Reject Mixer

The downconverter is implemented using an image-reject mixer consisting of an input buffer with dual outputs, each of which is fed to a double-balanced mixer. The LO signal is generated by an on-chip oscillator and an external tank circuit. The buffered oscillator signal drives a quadrature phase generator that provides two outputs with 90° of phase shift between them. This pair of LO signals is fed to the two receive mixers. The mixer's outputs are then passed through a pair of phase shifters, which provide 90° of phase shift across their outputs. The resulting two signals are then summed together. The final phase relationship is such that the desired signal is reinforced, and the image signal is largely canceled. The downconverter mixer's

Low-Voltage IF Transceiver with Limiter and RSSI

as possible for lowest phase noise. The tank's PC board layout is also critical to good performance (consult the *Layout Issues* section for more information).

The OSCOUT pin buffers the internal oscillator signal for driving an external PLL. This output should be AC coupled and terminated at the far end (typically the input to a prescaler) with a 50Ω load. If a larger output level is desired, you can use a resistive termination up to 100Ω. When a controlled-impedance PC board is used, this trace's impedance should match the termination impedance.

Power Management

The MAX2511 features four power-supply modes to preserve battery life. These modes are selected via the RXEN and TXEN pins, according to Table 1.

In shutdown mode, all part functions are off. In standby mode, the LO and the LO buffer are active. This allows a PLL (implemented externally to the MAX2511) to remain up and running, avoiding any delay resulting from PLL loop settling. Transmit (Tx) mode enables the LO circuitry, upconverter mixer, transmit VGA, and output driver amplifier. Receive (Rx) mode enables the LO circuitry, downconverter mixer, limiting amplifier, and adjustable output level amplifier.

Table 1. Power-Supply Mode Selection

RXEN STATE	TXEN STATE	MODE
Low	Low	Shutdown
Low	High	Transmit
High	Low	Receive
High	High	Standby

Applications Information

400MHz ISM Applications

The MAX2511 can be used in applications where the 200MHz to 440MHz signal is an RF (rather than an IF) signal, such as in 400MHz ISM applications. In this case, we recommend preceding the MAX2511 receiver section with a low-noise amplifier (LNA) that can operate over the same supply-voltage range. The MAX2630–MAX2633 family of amplifiers meets this requirement. But since these parts have single-ended inputs and outputs, it is necessary to AC terminate the unused MAX2511 input (RXIN) to ground with 47nF.

Oscillator Tank

The on-chip oscillator circuit requires a parallel resonant tank circuit connected across TANK and $\overline{\text{TANK}}$. Figure 3 shows an example of an oscillator tank circuit. Inductor L1 is resonated with the effective total capacitance of C1 in parallel with the series combination of C2, C3, and (CD1) / 2. CD1 is the capacitance of one of the varactor diodes. Typically, C2 = C3 to maintain symmetry. The effective parasitic capacitance, C_p (including PCB parasitics), is approximately 3.5pF. The total capacitance is given by the following equation:

$$C_{\text{EFF}} = \frac{1}{\frac{2}{C_2} + \frac{2}{C_{D1}}} + C_1 + C_p$$

Using this value for the resonant tank circuit, the oscillation frequency is as follows:

$$F_{\text{OSC}} = \frac{1}{2\pi\sqrt{L_1 C_{\text{EFF}}}}$$

Starting with the inductor recommended in Table 2, choose the component values according to your application needs, such as phase noise, tuning range, and VCO gain. Keep the tank's Q as high as possible to reduce phase noise. For most of the MAX2511's applications (such as a first IF to second IF transceiver), the oscillator's tuning range can be quite small, since the IF frequencies are not tuned for channel selection. This allows a narrowband oscillator tank to be used, which typically provides better phase noise and stability performance than wideband tank circuits. Careful PC board layout of the oscillator tank is essential. See the *Layout Issues* section for more information.

To overdrive the oscillator from an external 50Ω source, see Figure 4.

Rx Input Impedance Matching

The RXIN, $\overline{\text{RXIN}}$ port typically needs an impedance-matching network for proper connection to external circuitry such as a filter. See the *Typical Operating Circuit* for an example circuit topology. A shunt resistor across RXIN, $\overline{\text{RXIN}}$ can be used to set terminating impedance, with a slight degradation of the Noise Figure.

The component values used in the matching network depend on the desired operating frequency as well as the filter impedance. Table 3 indicates the RXIN, $\overline{\text{RXIN}}$ differential input impedance in both series and parallel form. This data is also plotted in the *Typical Operating Characteristics*.

Low-Voltage IF Transceiver with Limiter and RSSI

MAX2511

Filter Sharing

In half-duplex or TDD applications, the number of external filters can be minimized by combining transmit and receive filter paths (Figure 5).

The 10.7MHz filter that is usually connected to the TXIN, $\overline{\text{TXIN}}$ ports can be the same filter that is connected at LIMOUT and $\overline{\text{LIMOUT}}$. To use the same filter, connect TXIN to LIMOUT, and $\overline{\text{TXIN}}$ to $\overline{\text{LIMOUT}}$.

The 425MHz SAW filter needed at the RXIN, $\overline{\text{RXIN}}$ ports and the filter needed at TXOUT and $\overline{\text{TXOUT}}$ can be shared in a similar manner. The RXIN, $\overline{\text{RXIN}}$ ports must be DC blocked to prevent the bias voltage needed by the TXOUT and $\overline{\text{TXOUT}}$ pins from entering the receiver.

When sharing filters in this manner, the transmitter output port (TXOUT, $\overline{\text{TXOUT}}$) and receiver input port (RXIN, $\overline{\text{RXIN}}$) matching networks must be modified. The receiver port's input impedance must be the parallel combination of the receiver and transmitter ports in Rx mode. In this case, the receiver port is active, but the transmitter port adds an additional parasitic impedance. See the transmitter and receiver-port impedance graphs in the *Typical Operating Characteristics*.

When the part is in transmit mode, the RXIN and $\overline{\text{RXIN}}$ inputs provide back termination for the TXOUT and $\overline{\text{TXOUT}}$ outputs so that a single IF filter can be connected (Figure 5). With this technique, the matching network can be adjusted so the input VSWR is less than 1.5:1 in Rx mode, and the output VSWR is less than 2:1 in Tx mode.

Receive IF Filter

The interstage 10.7MHz filter, located between the MIXOUT pin and the LIMIN pin, is not shared. This filter prevents the limiter from acting on any undesired signals that are present at the mixer's output, such as LO feedthrough, out-of-band channel leakage, and other mixer products. This filter is also set up to pass DC bias voltage from the the VREF pin into the LIMIN and MIXOUT pins through two filter-termination resistors (330 Ω —see the *Typical Operating Circuit* for more information). If the filter can provide a DC shunt path, such as a transformer-capacitor based filter or some L-C filters, the two resistors can be combined into one parallel, equivalent resistor (165 Ω) to reduce component count (Figure 5—inset).

Layout Issues

A well-designed PC board is an essential part of an RF circuit. For best performance, pay attention to power-supply issues, as well as the layout of the matching networks and tank circuit.

Power-Supply Layout

For minimizing coupling between different sections of the chip, the ideal power-supply layout is a star configuration, which has a heavily decoupled central VCC node. The VCC traces branch out from this node, each going to one VCC node on the MAX2511. At the end of each of these traces is a bypass capacitor that is good at the RF frequency of interest. This arrangement provides local decoupling at each VCC pin. At high frequency, any signal leaking from a supply pin sees a relatively high impedance (formed by the VCC trace impedance) to the central VCC node, and an even higher impedance to any other supply pin.

Place the VREF decoupling capacitor (0.1 μF typ) as close to the MAX2511 as possible for best interstage filter performance. Use a high-quality, low-ESR capacitor for best results.

Matching Network Layout

The TXOUT, $\overline{\text{TXOUT}}$ port requires a bias network that consists of two inductors to VCC (for differential drive) and optionally a back-termination resistor for matching to an external filter. The RXIN, $\overline{\text{RXIN}}$ port also needs an impedance-matching network. Both networks should be symmetrical and as close to the chip as possible. See the *Typical Operating Circuit* for more details. If you use a ground-plane PC board, cut out the ground plane under the matching network components to reduce parasitic capacitance.

Local-Oscillator Tank Layout

Oscillator-tank circuit layout is critical. Parasitic PC board capacitance, as well as trace inductance, can affect oscillation frequency. Keep the tank layout symmetrical, tightly packed, and as close to the device as possible. If a ground-plane PC board is used, the ground plane should be cut out under the oscillator components to reduce parasitic capacitance.

Low-Voltage IF Transceiver with Limiter and RSSI

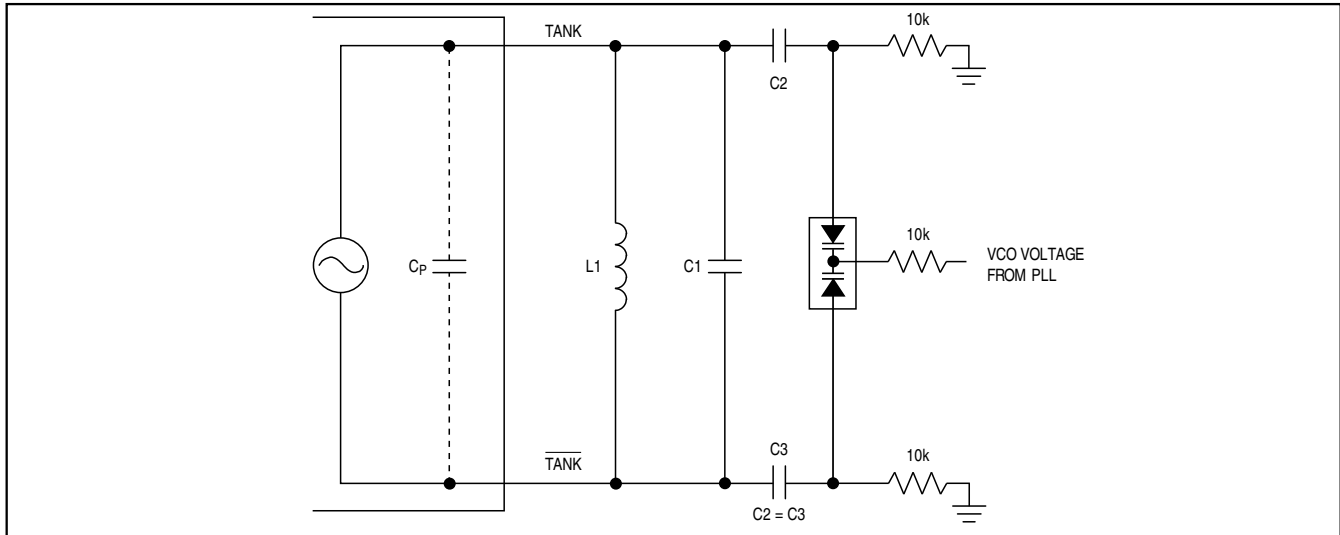

Figure 3. Oscillator Tank Schematic

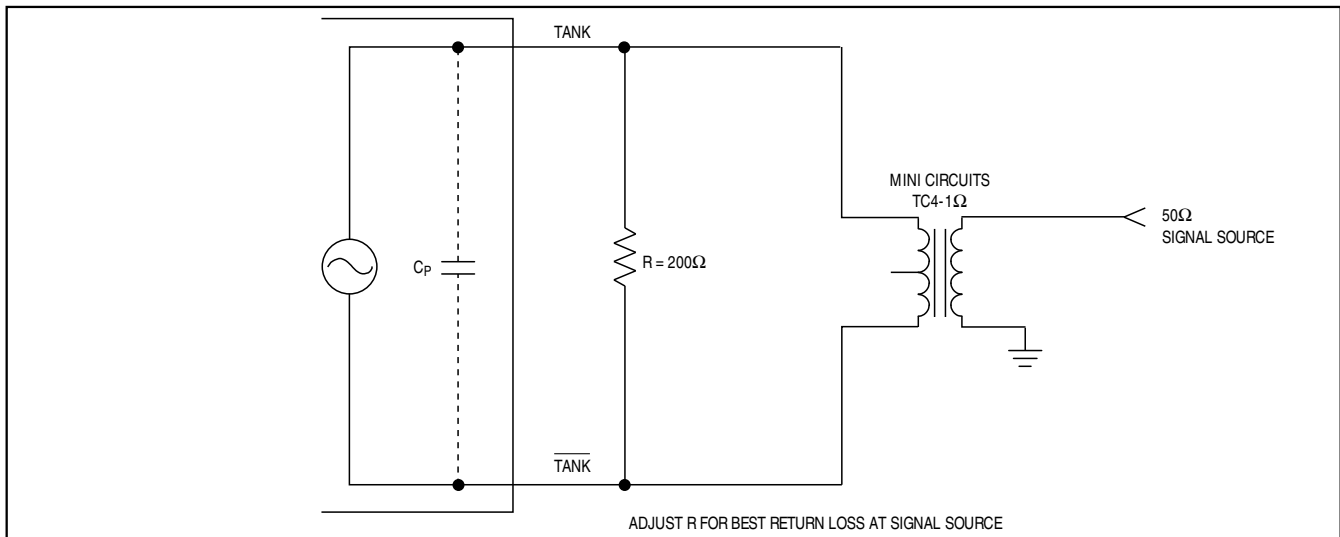

Figure 4. Overdriving the On-Chip Oscillator

Table 2. Recommended Values for L1

f_{LO} (MHz)	L1 (μ H)
200 to 300	18
300 to 400	12
400 to 500	8.2

Table 3. Rx Input Impedance

FREQUENCY (MHz)	SERIES IMPEDANCE (Ω)	EQUIVALENT PARALLEL IMPEDANCE	
		R (Ω)	C (pF)
100	274-j226	460	2.85
200	131-j186	395	2.86
300	79-j138	320	2.9
400	58-j105	248	2.9
500	48-j82	188	2.9
600	43-j62	132	2.9

Low-Voltage IF Transceiver with Limiter and RSSI

MAX2511

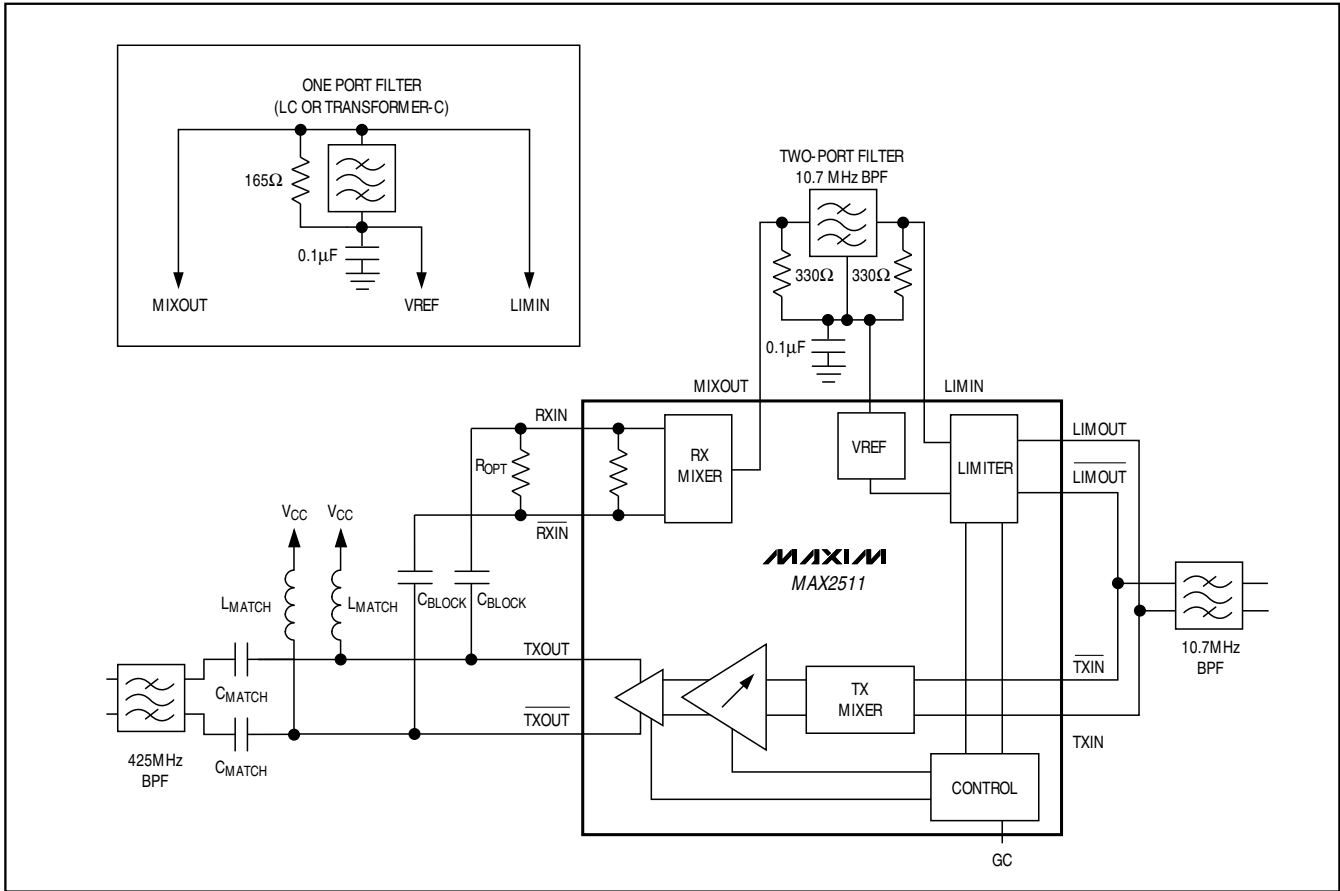

Figure 5. Filter Sharing

Low-Voltage IF Transceiver with Limiter and RSSI

Typical Operating Circuit

