



Chipsmall Limited consists of a professional team with an average of over 10 year of expertise in the distribution of electronic components. Based in Hongkong, we have already established firm and mutual-benefit business relationships with customers from,Europe,America and south Asia,supplying obsolete and hard-to-find components to meet their specific needs.

With the principle of “Quality Parts,Customers Priority,Honest Operation,and Considerate Service”,our business mainly focus on the distribution of electronic components. Line cards we deal with include Microchip,ALPS,ROHM,Xilinx,Pulse,ON,Everlight and Freescale. Main products comprise IC,Modules,Potentiometer,IC Socket,Relay,Connector.Our parts cover such applications as commercial,industrial, and automotives areas.

We are looking forward to setting up business relationship with you and hope to provide you with the best service and solution. Let us make a better world for our industry!



Contact us

Tel: +86-755-8981 8866 Fax: +86-755-8427 6832

Email & Skype: info@chipsmall.com Web: www.chipsmall.com

Address: A1208, Overseas Decoration Building, #122 Zhenhua RD., Futian, Shenzhen, China



MAX2870

23.5MHz to 6000MHz Fractional/Integer-N Synthesizer/VCO

General Description

The MAX2870 is an ultra-wideband phase-locked loop (PLL) with integrated voltage control oscillators (VCOs) capable of operating in both integer-N and fractional-N modes. When combined with an external reference oscillator and loop filter, the MAX2870 is a high-performance frequency synthesizer capable of synthesizing frequencies from 23.5MHz to 6.0GHz while maintaining superior phase noise and spurious performance.

The ultra-wide frequency range is achieved with the help of multiple integrated VCOs covering 3000MHz to 6000MHz, and output dividers ranging from 1 to 128. The device also provides dual differential output drivers, which can be independently programmable to deliver -4dBm to +5dBm output power. Both outputs can be muted by either software or hardware control.

The MAX2870 is controlled by a 4-wire serial interface and is compatible with 1.8V control logic. The device is available in a lead-free, RoHS-compliant, 5mm x 5mm, 32-pin TQFN package, and operates over an extended -40°C to +85°C temperature range.

Applications

Wireless Infrastructure	PMAR/LMAR/Public
Test and Measurement	Safety Radio
Satellite Communications	Clock Generation
Wireless LANs/CATV	

Benefits and Features

- Integer and Fractional-N Modes
- Manual or Automatic VCO Selection
- 3000MHz to 6000MHz Fundamental VCO
- Output Binary Buffers/Dividers for Extended Frequency Range
 - 1/2/4/8/16/32/64/128
 - 23.5MHz to 6000MHz
- High-Performance PFD
 - 105MHz in Integer-N Mode
 - 50MHz in Fractional-N Mode
- Reference Frequency Up to 200MHz
- Operates from +3.0V to +3.6V Supply
- Dual Programmable Outputs
 - -4dBm to +5dBm
- Analog and Digital Lock Detect Indicators
- Hardware and Software Shutdown Control
- Compatible with 1.8V Control Logic

Ordering Information appears at end of data sheet.

Typical Application Circuit appears at end of data sheet.

Functional Diagram

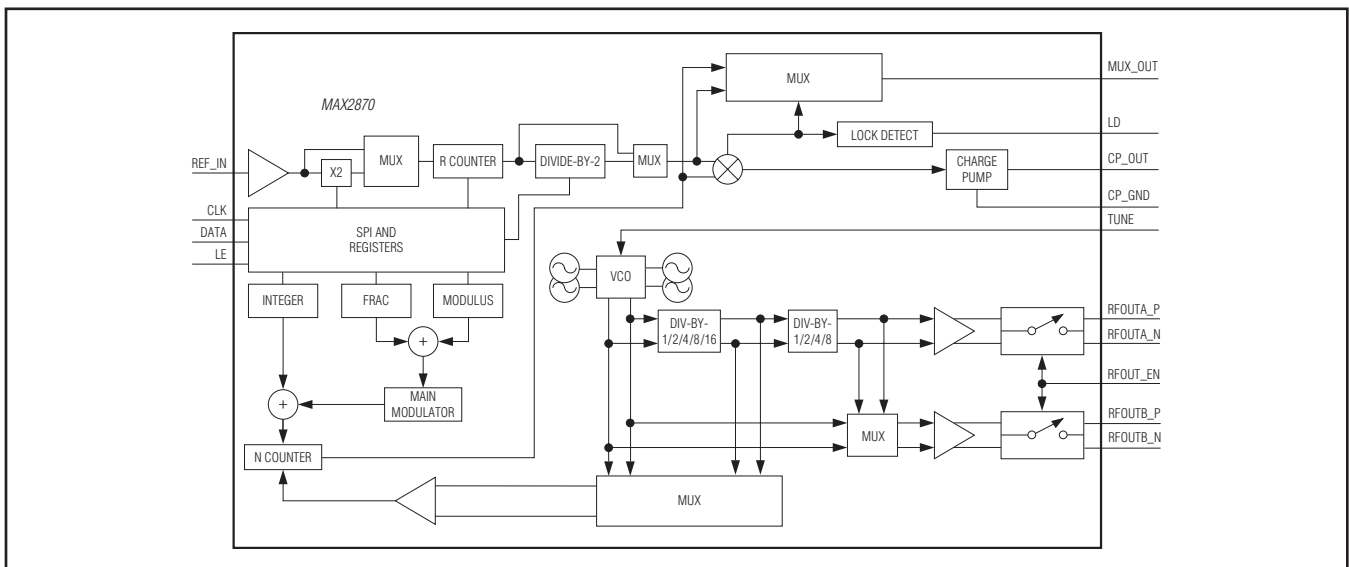

Absolute Maximum Ratings

V _{CC_} to GND_	-0.3V to +3.9V	Junction Temperature	+150°C
All Other Pins to GND_.....	-0.3V to V _{CC_} + 0.3V	Operating Temperature Range	-40°C to +85°C
Continuous Power Dissipation (T _A = +70°C)		Storage Temperature Range.....	-65°C to +150°C
TQFN-EP Multilayer Board		Lead Temperature (soldering, 10s)	+300°C
(derate 34.5mW/°C above +70°C).....	2758.6mW	Soldering temperature (reflow)	+260°C

Stresses beyond those listed under "Absolute Maximum Ratings" may cause permanent damage to the device. These are stress ratings only, and functional operation of the device at these or any other conditions beyond those indicated in the operational sections of the specifications is not implied. Exposure to absolute maximum rating conditions for extended periods may affect device reliability.

Package Thermal Characteristics (Note 1)

TQFN

Junction-to-Ambient Thermal Resistance (θ _{JA})	29°C/W	Junction-to-Case Thermal Resistance (θ _{JC})	1.7°C/W
---	--------	--	---------

Note 1: Package thermal resistances were obtained using the method described in JEDEC specification JESD51-7, using a four-layer board. For detailed information on package thermal considerations, refer to www.maximintegrated.com/thermal-tutorial.

DC Electrical Characteristics

(Measured using MAX2870 EV Kit. V_{CC_} = 3V to 3.6V, V_{GND_} = 0V, f_{REF_IN} = 50MHz, f_{PFD} = 25MHz, T_A = -40°C to +85°C. Typical values measured at V_{CC_} = 3.3V; T_A = +25°C; register settings (Reg 0:5) 00780000,20000141,01005E42,00000013,610F423C,01400005; unless otherwise noted.) (Note 2)

PARAMETER	CONDITIONS		MIN	TYP	MAX	UNITS
Supply Voltage			3	3.3	3.6	V
RFOUT_ Current Consumption	I _{RFOUT_} , minimum output power, single channel			8.5		mA
	I _{RFOUT_} , maximum output power, single channel			25	29	
Supply Current	Both channels enabled, maximum output power	Total, including RFOUT, both channel (Note 3)		144	180	mA
		Each output divide-by-2		10	15	
		I _{CCVCO} + I _{CCRF} (Note 3)		75	95	
		Low-power sleep mode			1	

AC Electrical Characteristics

(Measured using MAX2870 EV Kit. V_{CC_} = 3V to 3.6V, V_{GND_} = 0V, f_{REF_IN} = 50MHz, f_{PFD} = 25MHz, f_{RFOUT_} = 6000MHz, T_A = -40°C to +85°C. Typical values measured at V_{CC_} = 3.3V, T_A = +25°C, register settings (Reg 0:5) 00780000,20000141,01005E42,00000013,610F423C,01400005; unless otherwise noted.) (Note 2)

PARAMETER	CONDITIONS	MIN	TYP	MAX	UNITS
REFERENCE OSCILLATOR INPUT (REF_IN)					
REF_IN Input Frequency Range		10		200	MHz
REF_IN Input Sensitivity		0.7		V _{CC_}	V _{PP}
REF_IN Input Capacitance			2		pF
REF_IN Input Current		-60		+60	µA
PHASE DETECTOR					
Phase Detector Frequency	Integer-N mode			105	MHz
	Fractional-N mode			50	

AC Electrical Characteristics (continued)

(Measured using MAX2870 EV Kit. $V_{CC_} = 3V$ to $3.6V$, $V_{GND_} = 0V$, $f_{REF_IN} = 50MHz$, $f_{PFD} = 25MHz$, $f_{RFOUT_} = 6000MHz$, $T_A = -40^{\circ}C$ to $+85^{\circ}C$. Typical values measured at $V_{CC_} = 3.3V$, $T_A = +25^{\circ}C$, register settings (Reg 0:5) 00780000,20000141,01005E42,00000013,610F423C,01400005; unless otherwise noted.) (Note 2)

PARAMETER	CONDITIONS	MIN	TYP	MAX	UNITS
CHARGE PUMP					
Sink/Source Current	CP[3:0] = 1111, RSET = 5.1k Ω		5.12		mA
	CP[3:0] = 0000, RSET = 5.1k Ω		0.32		
RSET Range		2.7		10	k Ω
RF OUTPUTS					
Fundamental Frequency Range		3000		6000	MHz
Divided Frequency Range	With output dividers (1/2/4/8/16/32/64/128)	23.4375		6000	MHz
VCO Sensitivity			100		MHz/V
Frequency Pushing	Open loop		0.7		MHz/V
Frequency Pulling	Open loop into 2:1 VSWR		70		KHz
2nd Harmonic	Fundamental VCO output		40		dBc
3rd Harmonic	Fundamental VCO output		34		dBc
2nd Harmonic	VCO output divided-by-2		20		dBc
3rd Harmonic	VCO output divided-by-2		21		dBc
Maximum Output Power	$f_{RFOUT_} = 3000MHz$ (Note 4)		5		dBm
Minimum Output Power	$f_{RFOUT_} = 3000MHz$ (Note 4)		-4		dBm
Output Power Variation (Note 4)	$-40^{\circ}C \leq T_A \leq +85^{\circ}C$		1.5		dB
	$3V \leq V_{CC_} \leq 3.6V$		0.2		
Muted Output Power	(Note 4)		-31		dBm
VCO AND FREQUENCY SYNTHESIZER NOISE					
VCO Phase Noise (Note 5)	VCO at 3000MHz	10kHz offset		-83.5	dBc/Hz
		100kHz offset		-111	
		1MHz offset		-136	
		5MHz offset		-149	
	VCO at 4500MHz	10kHz offset		-75	
		100kHz offset		-104	
		1MHz offset		-130	
		5MHz offset		-145.5	
	VCO at 6000MHz	10kHz offset		-71.5	
		100kHz offset		-100.5	
		1MHz offset		-128.0	
		5MHz offset		-143.5	
In-Band Noise Floor	Normalized (Note 6)		-226.4		dBc/Hz
1/f Noise	Normalized (Note 7)		-116		dBc/Hz
In-Band Phase Noise	(Note 8)		-95		dBc/Hz
Integrated RMS Jitter	(Note 9)		0.25		ps
Spurious Signals Due to PFD Frequency			-87		dBc
VCO Tune Voltage		0.5		2.5	V

Digital I/O Characteristics

($V_{CC_} = +3V$ to $+3.6V$, $V_{GND_} = 0V$, $T_A = -40^{\circ}C$ to $+85^{\circ}C$. Typical values at $V_{CC_} = 3.3V$, $T_A = +25^{\circ}C$.) (Note 2)

PARAMETER	CONDITIONS	MIN	TYP	MAX	UNITS
SERIAL INTERFACE INPUTS (CLK, DATA, LE, CE, RFOUT_EN)					
Input Logic-Level Low	V_{IL}			0.4	V
Input Logic-Level High	V_{IH}	1.5			V
Input Current	I_{IH}/I_{IL}	-1		+1	μA
Input Capacitance			1		pF
SERIAL INTERFACE OUTPUTS (MUX_OUT, LD)					
Output Logic-Level Low	0.3mA sink current			0.4	V
Output Logic-Level High	0.3mA source current	$V_{CC} - 0.4$			V
Output Current Level High				0.5	mA

SPI Timing Characteristics

($V_{CC_} = +3V$ to $+3.6V$, $V_{GND_} = 0V$, $T_A = -40^{\circ}C$ to $+85^{\circ}C$. Typical values at $V_{CC_} = 3.3V$, $T_A = +25^{\circ}C$.) (Note 2)

PARAMETER	SYMBOL	CONDITIONS	MIN	TYP	MAX	UNITS
CLK Clock Period	t_{CP}	Guaranteed by SCL pulse-width low and high	50			ns
CLK Pulse-Width Low	t_{CL}		25			ns
CLK Pulse-Width High	t_{CH}		25			ns
LE Setup Time	t_{LES}		20			ns
LE Hold Time	t_{LEH}		10			ns
LE Minimum Pulse-Width High	t_{LEW}		20			ns
Data Setup Time	t_{DS}		25			ns
Data Hold Time	t_{DH}		25			ns
MUX_OUT Setup Time	t_{MS}		10			ns
MUX_OUT Hold Time	t_{MH}		10			ns

Note 2: Production tested at $T_A = +25^{\circ}C$. Cold and hot are guaranteed by design and characterization.

Note 3: $f_{REFIN} = 100MHz$, phase detector frequency = 25MHz, RF output = 6000MHz.
Register setting: 00780000, 20400061, 20011242, F8010003, 608001FC, 80440005

Note 4: Measured single ended with 27nH to V_{CC_RF} into 50 Ω load. Power measured with single output enabled. Unused output has 27nH to V_{CC_RF} with 50 Ω termination.

Note 5: VCO phase noise is measured open loop.

Note 6: Measured at 200kHz using a 50MHz Bliley NV108C19554 OCVCXO with 2MHz loop bandwidth. Register setting 801E0000, 8000FFF9, 80005FC2, 6C10000B, 638E80FC, 400005. EV kit loop filter: C13 = 1500pF, C14 = 33pF, R1 = 0 Ω , R2 = 1100 Ω , R0 = 0 Ω , C12 = open.

Note 7: 1/f noise contribution to the in-band phase noise is computed by using $1/f_{noise} + 10\log(10kHz/f_{OFFSET}) + 20\log(f_{RF}/1GHz)$. Register setting: 803A0000,8000FFF9,81005F42,F4000013,6384803C,001500005

Note 8: $f_{REFIN} = 50MHz$; $f_{PFD} = 25MHz$; offset frequency = 10kHz; VCO frequency = 4227MHz, output divide-by-2 enabled. RFOUT = 2113.5MHz; N = 169; loop BW = 40kHz, CP[3:0] = 1111; integer mode.

Note 9: $f_{REFIN} = 50MHz$; $f_{PFD} = 50MHz$; VCO frequency = 4400MHz, $f_{RFOUT} = 4400MHz$; loop BW = 65kHz. Register setting: 002C0000, 200303E9, 80005642, 00000133, 638E82FC, 01400005. EV kit loop filter: C13 = 0.1 μF , C14 = 0.012 μF , R1 = 0 Ω , R2 = 120 Ω , R0 = 250 Ω , C12 = 820pF.

Typical Operating Characteristics

(Measured with MAX2870 EV Kit. $V_{CC_} = 3.3V$, $V_{GND_} = 0V$, $f_{REF_IN} = 50MHz$, $T_A = +25^{\circ}C$, see the Testing Conditions Table.)

3.0GHz VCO OPEN-LOOP PHASE NOISE vs. FREQUENCY

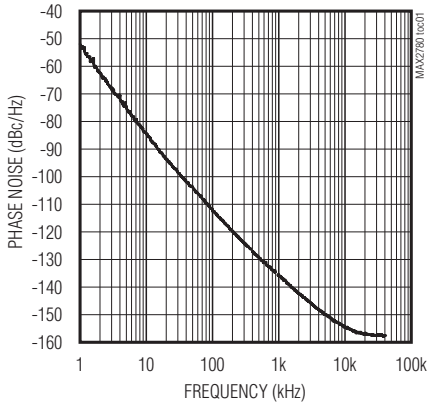

4.5GHz VCO OPEN-LOOP PHASE NOISE vs. FREQUENCY

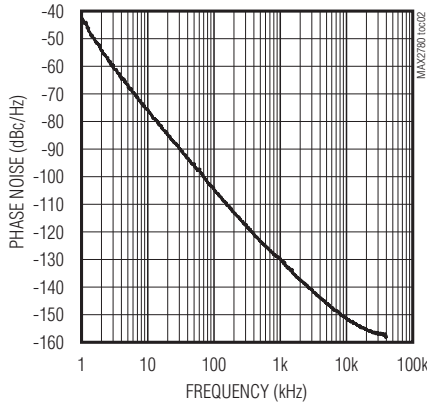

6.0GHz VCO OPEN-LOOP PHASE NOISE vs. FREQUENCY

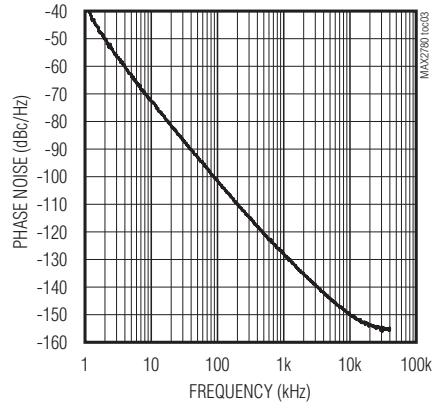

3.0GHz CLOSED-LOOP PHASE NOISE vs. FREQUENCY

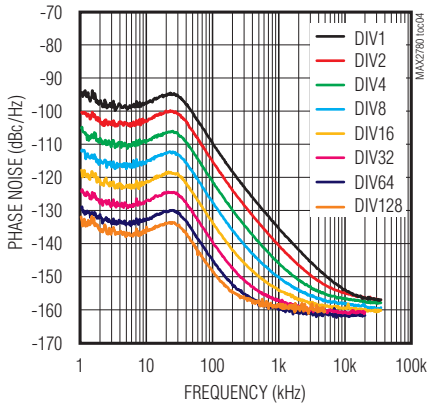

4.5GHz CLOSED-LOOP PHASE NOISE vs. FREQUENCY

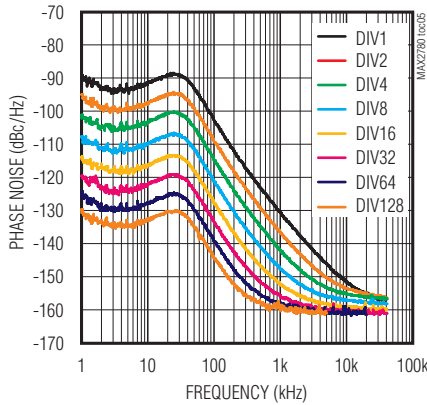

6.0GHz CLOSED-LOOP PHASE NOISE vs. FREQUENCY

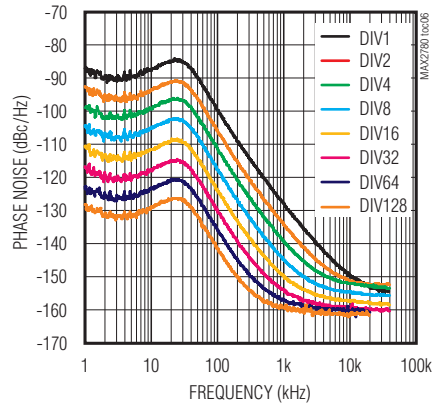

904MHz INTEGER-N MODE PHASE NOISE AND SPUR PERFORMANCE vs. FREQUENCY

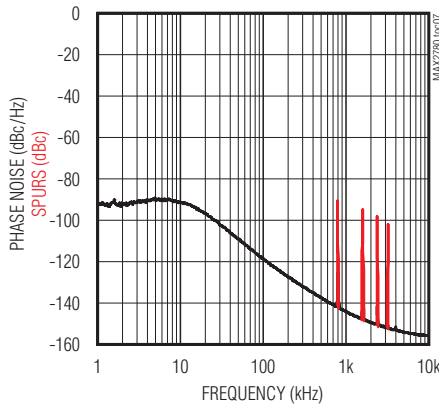

2687.5MHz INTEGER-N MODE PHASE NOISE AND SPUR PERFORMANCE vs. FREQUENCY

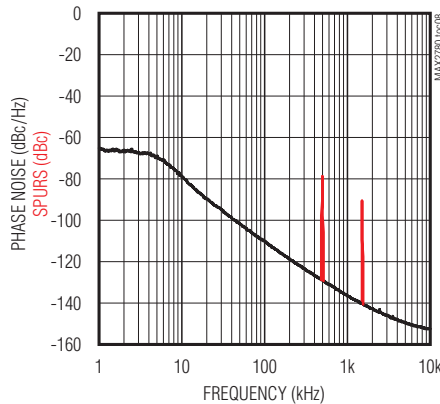

2113.5MHz FRACTIONAL-N PHASE NOISE (LOW-NOISE MODE) vs. FREQUENCY

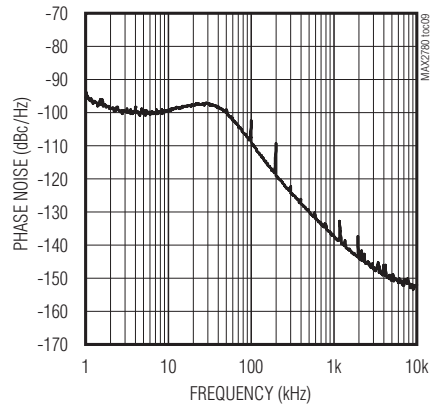

Typical Operating Characteristics (continued)

(Measured with MAX2870 EV Kit. $V_{CC_} = 3.3V$, $V_{GND_} = 0V$, $f_{REF_IN} = 50MHz$, $T_A = +25^\circ C$, see the Testing Conditions Table.)

2113.5MHz FRACTIONAL-N PHASE NOISE vs. FREQUENCY (LOW-SPUR MODE)

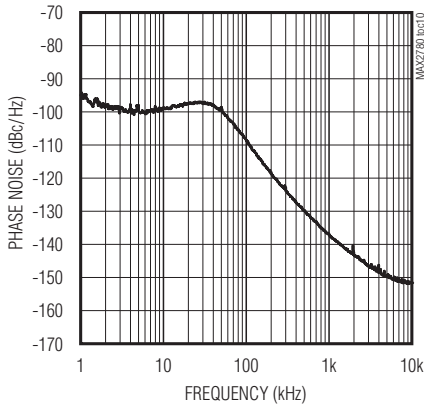

2679.4MHz FRACTIONAL-N PHASE NOISE vs. FREQUENCY (LOW-NOISE MODE)

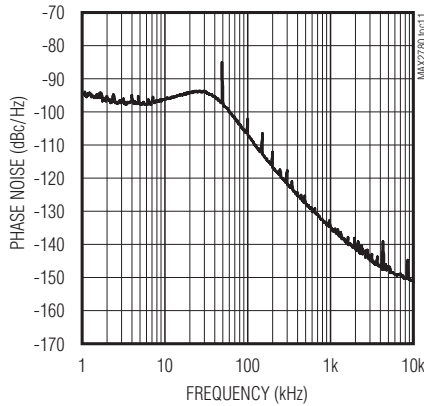

2679.4MHz FRACTIONAL-N PHASE NOISE vs. FREQUENCY (LOW-SPUR MODE)

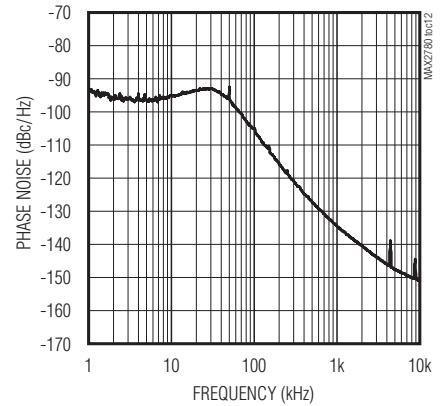

SUPPLY CURRENT vs. OUTPUT POWER SETTING (ONE CHANNEL ACTIVE, 3GHz)

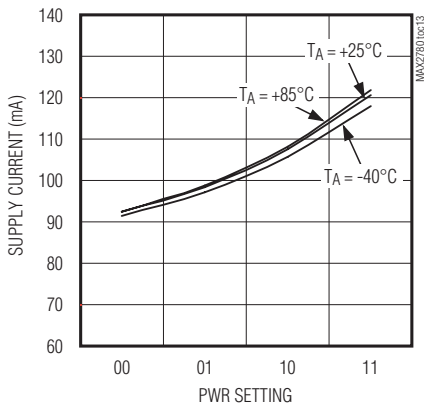

SUPPLY CURRENT vs. FREQUENCY (ONE CHANNEL ACTIVE, MAXIMUM OUTPUT POWER)

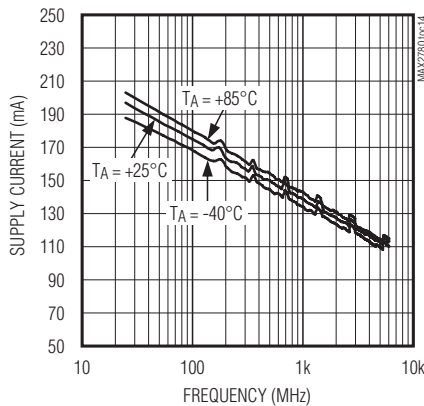

SUPPLY CURRENT vs. OUTPUT POWER SETTING (TWO CHANNELS ACTIVE)

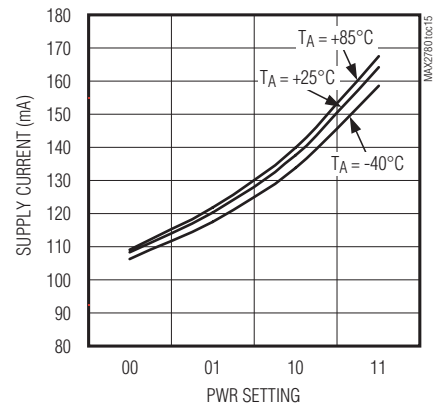

Typical Operating Characteristics (continued)

(Measured with MAX2870 EV Kit. $V_{CC_} = 3.3V$, $V_{GND_} = 0V$, $f_{REF_IN} = 50MHz$, $T_A = +25^\circ C$, see the Testing Conditions Table.)

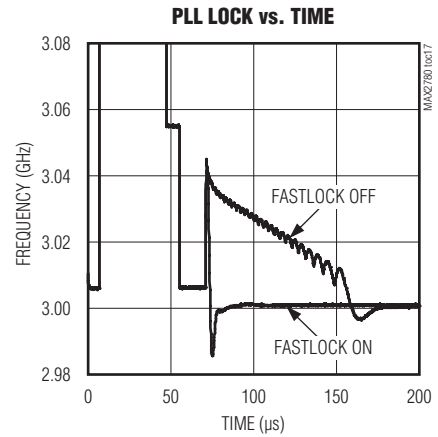
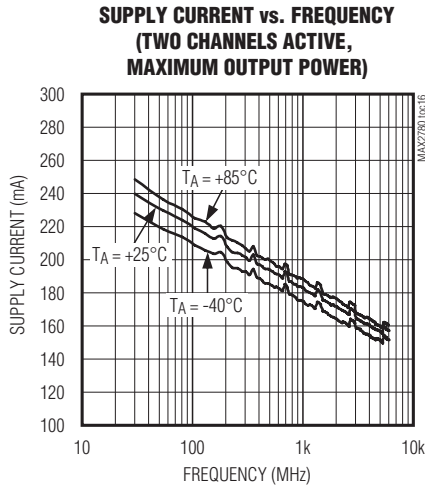

Typical Operating Characteristics Testing Conditions Table

TOC TITLE	fREF (MHz)	fPFD (MHz)	REGISTER SETTINGS (hex)	LOOP FILTER BW (Hz)	MAX2870 EV KIT COMPONENT VALUES					COMMENTS
					C2 (F)	R2A + R2B (Ω)	C1 (F)	R3 (Ω)	C3 (F)	
3.0GHz VCO OPEN-LOOP PHASE NOISE vs. FREQUENCY	N/A	N/A	80B40000, 80000141, 0000405A, XX00013, 648020FC, 00000005	N/A	N/A	N/A	N/A	N/A	N/A	VCO bits set for 3GHz output, VAS_SHDN = 1
4.5GHz VCO OPEN-LOOP PHASE NOISE vs. FREQUENCY	N/A	N/A	80B40000, 80000141, 0000405A, XX00013, 648020FC, 00000005	N/A	N/A	N/A	N/A	N/A	N/A	VCO bits set for 4.5GHz output, VAS_SHDN = 1
6.0GHz VCO OPEN-LOOP PHASE NOISE vs. FREQUENCY	N/A	N/A	80B40000, 80000141, 0000405A, XX00013, 648020FC, 00000005	N/A	N/A	N/A	N/A	N/A	N/A	VCO bits set for 6.0GHz output, VAS_SHDN = 1

Typical Operating Characteristics Testing Conditions Table

TOC TITLE	fREF (MHz)	fPFD (MHz)	REGISTER SETTINGS (hex)	Loop Filter BW (Hz)	MAX2870 EV KIT COMPONENT VALUES					COMMENTS
					C2 (F)	R2A + R2B (Ω)	C1 (F)	R3 (Ω)	C3 (F)	
3.0GHz CLOSED-LOOP PHASE NOISE vs. FREQUENCY	50	25	803C0000 80000141 00009E42, E8000013, 618160FC, 00400005	40k	0.1μ	120	0.012μ	250	820p	
4.5GHz CLOSED-LOOP PHASE NOISE vs. FREQUENCY	50	25	805A0000, 80000141, 00009E42, E8000013, 618160FC, 00400005	40k	0.1μ	120	0.012μ	250	820p	
6.0GHz CLOSED-LOOP PHASE NOISE vs. FREQUENCY	50	25	80780000, 0080000141, 00009E42, EA000013, 608C80FC, 00400005	40k	0.1μ	120	0.012μ	250	820p	
904MHz INTEGER-N MODE PHASE NOISE AND SPUR PERFORMANCE vs. FREQUENCY	40	0.8	82350000, 800007D1 E1065FC2, 2C000013 6020803C 00400005	16k	0.1μ	806	3300p	1201	470p	
2687.5MHz INTEGER-N PHASE NOISE AND SPUR PERFORMANCE vs. FREQUENCY	40	0.5	94FF0000, 803207D1, 010A1E42, B00000A3, 6090803C, 00400005	5k	0.1μ	1000	6800p	300	0.01μ	
2113.5MHz FRACTIONAL-N PHASE NOISE (LOW-NOISE MODE) vs. FREQUENCY	50	25	00548050, 400003E9, 81005FC2, E8000013, 609C80FC, 00400005	40k	0.1μ	120	0.012μ	250	820p	
2113.5MHz FRACTIONAL-N PHASE NOISE vs. FREQUENCY (LOW-SPUR MODE)	50	25	00548050, 400003E9, E1005FC2, E8000013, 609C80FC, 00400005	40k	0.1μ	120	0.012μ	250	820p	

Typical Operating Characteristics Testing Conditions Table

TOC TITLE	fREF (MHz)	fPFD (MHz)	REGISTER SETTINGS (hex)	Loop Filter BW (Hz)	MAX2870 EV KIT COMPONENT VALUES					COMMENTS
					C2 (F)	R2A + R2B (Ω)	C1 (F)	R3 (Ω)	C3 (F)	
2679.4MHz FRACTIONAL-N PHASE NOISE vs. FREQUENCY (LOW-NOISE MODE)	50	25	00358160, 203207D1, 01005E42, B20000A3, 6010003C, 00400005	40k	0.1μ	120	0.012μ	250	820p	
2679.4MHz FRACTIONAL-N PHASE NOISE vs. FREQUENCY (LOW-SPUR MODE)	50	25	00358160, 203207D1, 41005E42, B20000A3, 6010003C, 00400005	40k	0.1μ	120	0.012μ	250	820p	
SUPPLY CURRENT vs. OUTPUT POWER SETTING (ONE CHANNEL ACTIVE, 3GHz)	50	25	003C0000, 20000321, 01005E42, 00000013, 610F423C, 01400005,							APWR swept from 00 to 11
SUPPLY CURRENT vs. FREQUENCY (ONE CHANNEL ACTIVE, MAXIMUM OUTPUT POWER)	50	25	003C0000, 20000321, 01005E42, 00000013, 610F423C, 01400005							N and F values changed for each frequency
SUPPLY CURRENT vs. OUTPUT POWER SETTING (TWO CHANNELS ACTIVE)	50	25	003C0000, 20000321, 01005E42, 00000013, 610F43FC, 01400005							APWR and BPWR swept from 00 to 11
SUPPLY CURRENT vs. FREQUENCY (TWO CHANNELS ACTIVE MAXIMUM OUTPUT POWER)	50	25	003C0000, 20000321, 01005E42, 00000013, 610F43FC, 01400005							N and F values swept for each frequency
PLL LOCK vs. TIME	40	40	00250120, 20320141, 00004042, 000000A3, 0184023C, 01400005	40k	0.1μ	120	0.012μ	250	820p	CDM changed from 00 to 01

Pin Configuration

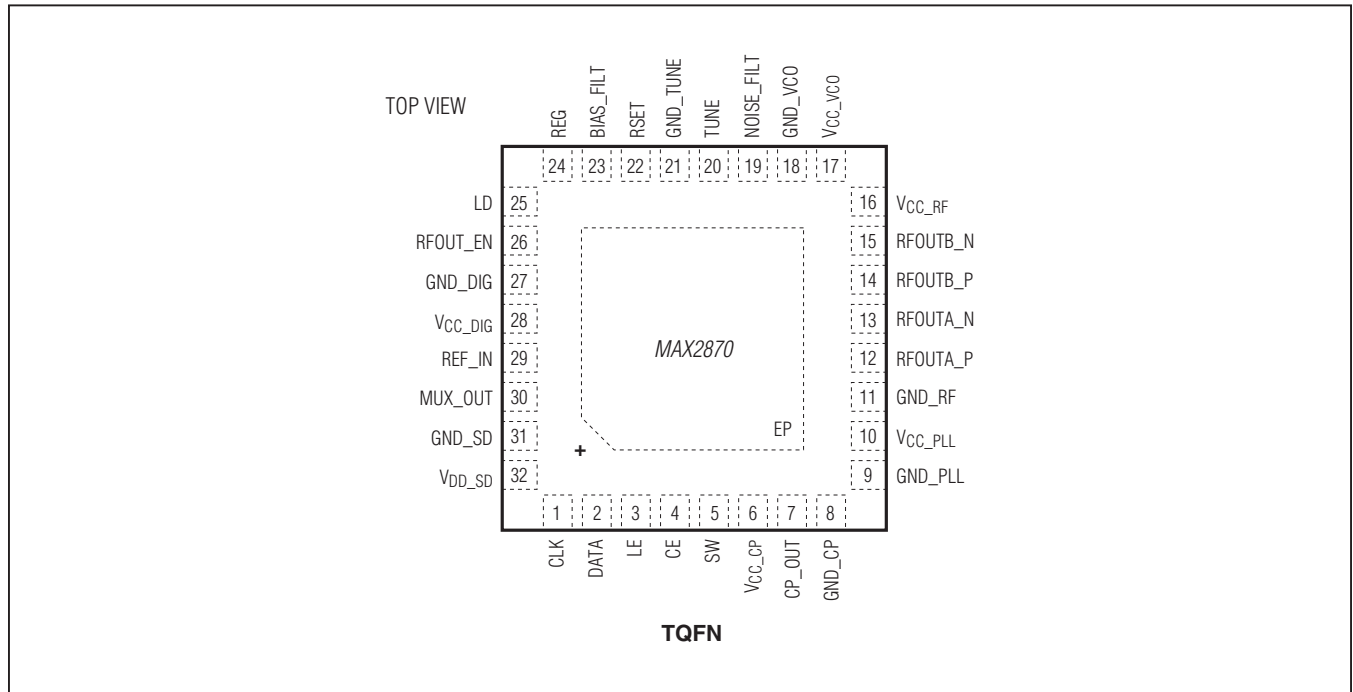

Pin Description

PIN	NAME	FUNCTION
1	CLK	Serial Clock Input. The data is latched into the 32-bit shift register on the rising edge of the CLK line.
2	DATA	Serial Data Input. The serial data is loaded MSB first. The 3 LSBs identify the register address.
3	LE	Load Enable Input. When LE goes high the data stored in the shift register is loaded into the appropriate latches.
4	CE	Chip Enable. A logic-low powers the part down and the charge pump becomes high impedance.
5	SW	Fast-Lock Switch. Connect to the loop filter when using the fast-lock mode. No connect in Normal mode
6	VCC_CP	Power Supply for Charge Pump. Place decoupling capacitors as close as possible to the pin.
7	CP_OUT	Charge-Pump Output. Connect to external loop filter input.
8	GND_CP	Ground for Charge-Pump. Connect to board ground, not to the paddle.
9	GND_PLL	Ground for PLL. Connect to main board ground plane, not to the paddle.
10	VCC_PLL	Power Supply for PLL. Place decoupling capacitors as close as possible to the pin.
11	GND_RF	Ground for RF Outputs. Connect to board ground plane, not to the paddle.
12	RFOUTA_P	Open Collector Positive RF Output A. Connect to supply through RF choke or 50Ω load.

Pin Description (continued)

PIN	NAME	FUNCTION
13	RFOUTA_N	Open Collector Negative RF Output A. Connect to supply through RF choke or 50Ω load.
14	RFOUTB_P	Open Collector Positive RF Output B. Connect to supply through RF choke or 50Ω load.
15	RFOUTB_N	Open Collector Negative RF Output B. Connect to supply through RF choke or 50Ω load.
16	VCC_RF	Power Supply for RF Output and Dividers. Place decoupling capacitors as close as possible to the pin.
17	VCC_VCO	VCO Power Supply. Place decoupling capacitors to the analog ground plane.
18	GND_VCO	Ground for VCO. Connect to main board ground plane, not directly to the paddle.
19	NOISE_FILT	VCO Noise Decoupling. Place a 1μF capacitor to ground.
20	TUNE	Control Input to the VCO. Connect to external loop filter.
21	GND_TUNE	Ground for Control Input to the VCO. Connect to main board ground plane, not directly to the paddle.
22	RSET	Charge-Pump Current Range Input. Connect an external resistor to ground to set the minimum CP current. $ICP = 1.63/RSET \times (1 + CP)$
23	BIAS_FILT	VCO Noise Decoupling. Place a 1μF capacitor to ground.
24	REG	Reference Voltage Compensation. Place a 1μF capacitor to ground.
25	LD	Lock Detect Output. Logic-high when locked, and logic-low when unlocked. See register description for more details (Table 9).
26	RFOUT_EN	RF Output Enable. A logic-low disables the RF outputs.
27	GND_DIG	Ground for Digital circuitry. Connect to main board ground plane, not directly to the paddle.
28	VCC_DIG	Power Supply for Digital Circuitry. Place decoupling capacitors as close as possible to pin.
29	REF_IN	Reference Frequency Input. This is a high-impedance input with a nominal bias voltage of VCC_DIG/2. AC-couple to reference signal.
30	MUX_OUT	Multiplexed Output and Serial Data Out. See Table 6.
31	GND_SD	Ground for Sigma-Delta Modulator. Connect to main board ground plane, not directly to the paddle.
32	VCC_SD	Power Supply for Sigma-Delta Modulator. Place decoupling capacitors as close as possible to the pin.
—	EP	Exposed Pad. Connect to board ground.

Detailed Description

4-Wire Serial Interface

The MAX2870 can be controlled by 3-wire SPI for write operation using CLK, DATA, LE pins, refer Figure 1. For read operation, in addition to the above 3 pins, MUX_OUT pin can be used to access Reg, 0x06, refer figure 2.

The MAX2870 serial interface contains six write-only and one read-only 32-bit registers. The 29 most-significant bits (MSBs) are data, and the three least-significant bits (LSBs) are the register address. Register data is loaded MSB first through the 4-wire serial interface (SPI). When

LE is logic-low, the logic level at DATA is shifted at the rising edge of CLK. At the rising edge of LE, the 29 data bits are latched into the register selected by the address bits. The user must program all register values after power-up.

Upon power-up, the registers should be programmed twice with at least a 20ms pause between writes. The first write ensures that the device is enabled, and the second write starts the VCO selection process. Recommended to turn-off the outputs during this sequence and then turn-on the outputs using RFA_EN, RFB_EN.

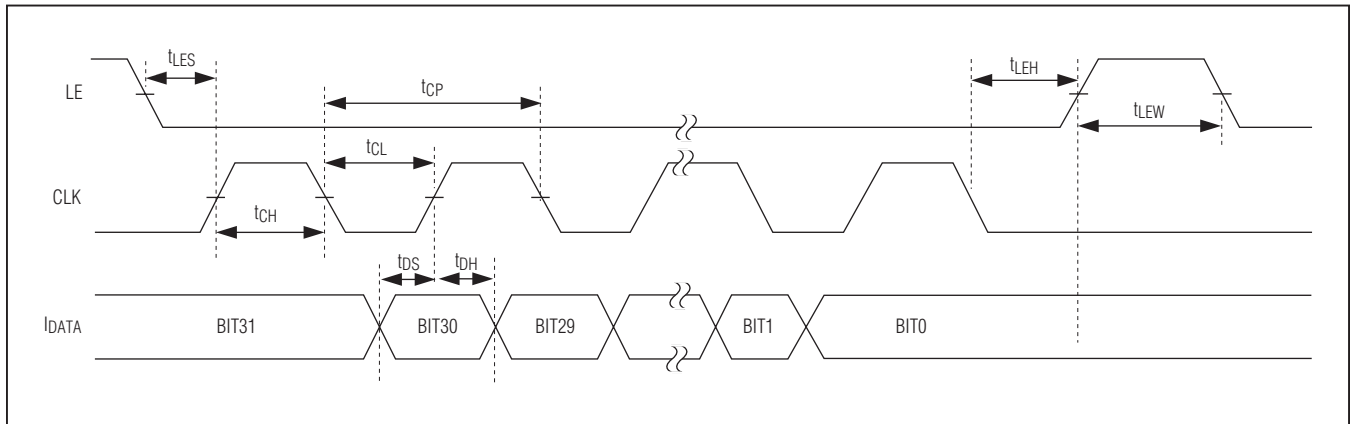

Figure 1. SPI Timing Diagram

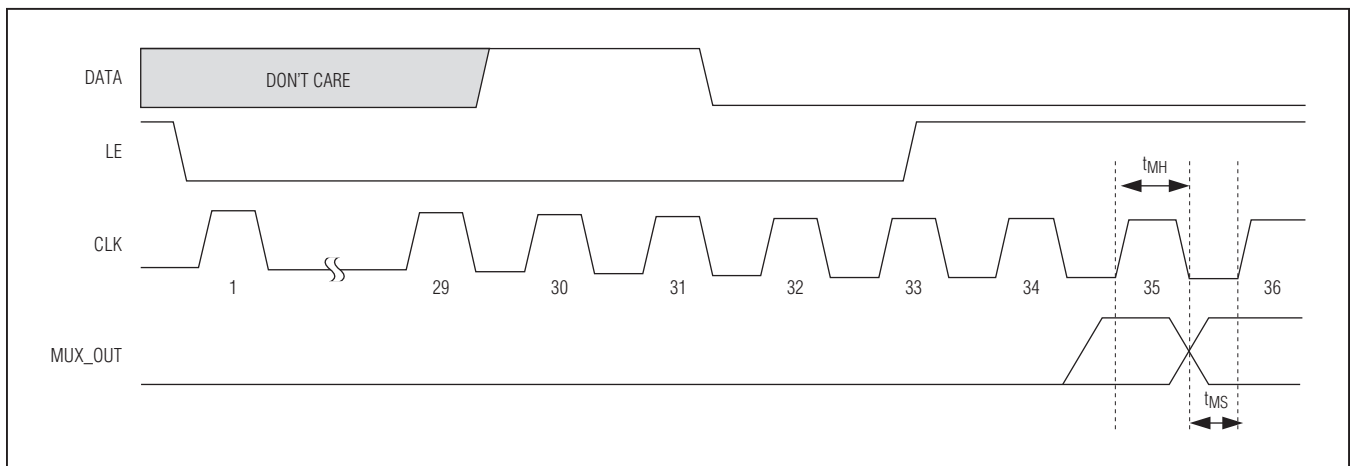

Figure 2. Initiating Readback

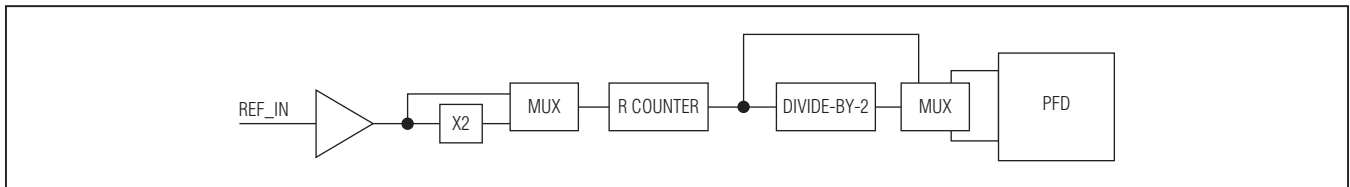

Figure 3. Reference Input

For a clean clock at start up, after power on, follow this sequence of programming:

- Register 5, Address 0X05. Wait 20ms
- Register 4, set bit 4 and 8 to 0 to keep RFOUT disabled
- Register 3, Address 0X03
- Register 2, Address 0X02
- Register 1, Address 0X01
- Register 0, Address 0X00
- Register 5, Address 0X05
- Register 4, set bit 4 and 8 to 0 to keep RFOUT disabled
- Register 3, Address 0X03
- Register 2, Address 0X02
- Register 1, Address 0X01
- Register 0, Address 0X00

To enable RFOUT, Register 4, Address 0X04, set bit 4 and 8 to 0.

Register programming order should be address 0x05, 0x04, 0x03, 0x02, 0x01, and 0x00. Several bits are double-buffered to update the settings at the same time. See the register descriptions for double-buffered settings.

Read Sequence

Register 0x06 can be read back through MUX_OUT. The user must set MUX = 1100. To begin the read sequence, set LE to logic-low, send 32 periods of CLK, and set LE to logic-high. While the CLK is running, the DATA pin can be held at logic-high or logic-low for 29 clocks, but the last 3 bits must be 110 to indicate register 6. Then finally, send 1 period of the clock. The MSB of register 0x06 appears on the falling edge of the next clock and continues to shift out for the next 29 clock cycles (Figure 2). After the LSB of register 0x06 has been read, the user can reset MUX = 0000.

Power Modes

The MAX2870 can be put into low-power mode by setting SHDN = 1 (register 2, bit 5) or by setting the CE pin to logic-low. In low-power mode, all blocks except SPI are off.

After exiting low-power mode, allow at least 20ms for external capacitors to charge to their final values before programming the final VCO frequency.

Reference Input

The reference input stage is configured as a CMOS inverter with shunt resistance from input to output. In shutdown mode this input is set to high impedance to prevent loading of the reference source.

The reference input signal path also includes optional x2 and ÷2 blocks. When the reference doubler is enabled (DBR = 1), the maximum reference input frequency is limited to 100MHz. When the doubler is disabled, the reference input frequency is limited to 200MHz. The minimum reference frequency is 10MHz. The minimum R counter divide ratio is 1, and the maximum divide ratio is 1023.

PFD Frequency

The phase-detector frequency is determined as follows:

$$f_{\text{PFD}} = f_{\text{REF}} \times [(1 + \text{DBR}) / (R \times (1 + \text{RDIV2}))]$$

f_{REF} represents the external reference input frequency. DBR (register 2, bit 25) sets the f_{REF} input frequency doubler mode (0 or 1). RDIV2 (register 2, bit 24) sets the f_{REF} divide-by-2 mode (0 or 1). R (register 2, bits 23:14) is the value of the 10-bit programmable reference counter (1 to 1023). The maximum f_{PFD} is 50MHz for frac-N mode and 105MHz for int-N mode. The R-divider can be held in reset when RST (register 2, bit 3) = 1.

Int, Frac, Mod, and R Counter Relationship

The VCO frequency (f_{VCO}), N, F, and M can be determined based on desired RF output frequency (f_{RFOUTA}) as follows:

Set DIVA value property based on f_{RFOUTA} and DIVA register table (register 4[22:20])

$$f_{\text{VCO}} = f_{\text{RFOUTA}} \times \text{DIVA}$$

If bit FB = 1, (DIVA is not in PLL feedback loop):

$$N + (F/M) = f_{\text{VCO}} / f_{\text{PFD}}$$

If bit FB = 0, (DIVA is in PLL feedback loop) and DIVA \leq 16:

$$N + (F/M) = (f_{\text{VCO}} / f_{\text{PFD}}) / \text{DIVA}$$

If bit FB = 0, (DIVA is in PLL feedback loop) and DIVA > 16:

$$N + (F/M) = (f_{\text{VCO}} / f_{\text{PFD}}) / 16$$

N is the value of the 16-bit N counter (16 to 65535), programmable through bits 30:15 of register 0. M is the fractional modulus value (2 to 4095), programmable through bits 14:3 of register 1. F is the fractional division value (0 to MOD - 1), programmable through bits 14:3 of register 0. In frac-N mode, the minimum N value is 19 and maximum N value is 4091. The N counter is held in reset when RST = 1 (register 2, bit 3). DIVA is the RF output divider setting (0 to 7), programmable through bits 22:20 of register 4. The division ratio is set by 2^{DIVA} .

The RF B output frequency is determined as follows:

If BDIV = 0 (register 4, bit 9), $f_{\text{RFOUTB}} = f_{\text{RFOUTA}}$.

If BDIV = 1, $f_{\text{RFOUTB}} = f_{\text{VCO}}$.

Int-N/Frac-N Modes

Integer-N mode is selected by setting bit INT = 1 (register 0, bit 31). When operating in integer-N mode, it is also necessary to set bit LDF (register 2, bit 8) to set the lock detect to integer-N mode.

The device's frac-N mode is selected by setting bit INT = 0 (register 0, bit 31). Additionally, set bit LDF = 0 (register 2, bit 8) for frac-N lock-detect mode.

If the device is in frac-N mode, it will remain in frac-N mode when fractional division value F = 0, which can result in unwanted spurs. To avoid this condition, the device can automatically switch to integer-N mode when F = 0 if the bit F01 = 1 (register 5, bit 24).

Phase Detector and Charge Pump

The device's charge-pump current is determined by the value of the resistor from pin RSET to ground and the value of bits CP (register 2, bits 12:9) as follows:

$$I_{\text{CP}} = 1.63 / R_{\text{SET}} \times (1 + \text{CP})$$

To reduce spurious in frac-N mode, set charge-pump linearity bit CPL = 1 (register 1, bits 30:29). For int-N mode, set CPL = 0. For lower noise operation in int-N mode, set charge-pump output clamp bit CPOC = 1 (register 1, bit 31) to prevent leakage current onto the loop filter. For frac-N mode, set CPOC = 0.

The charge-pump output can be put into high-impedance mode when TRI = 1 (register 2, bit 4). The output is in normal mode when TRI = 0.

The phase detector polarity can be changed if an active inverting loop filter topology is used. For noninverting loop filters, set PDP = 1 (register 2, bit 6). For inverting loop filters, set PDP = 0.

MUX_OUT and Lock Detect

MUX_OUT is a multipurpose test output for observing various internal functions of the MAX2870. MUX_OUT can also be configured as serial data output. Bits MUX (register 2, bit 28:26) are used to select the desired MUX_OUT signal (see Table 6).

Lock detect can be monitored through the LD output by setting the LD bits (register 5, bits 23:22). For digital lock detect, set LD = 01. The digital lock detect is dependent on the mode of the synthesizer. In frac-N mode set LDF = 0, and in int-N mode set LDF = 1. To set the accuracy of the digital lock detect, see Table 1 and Table 2.

Analog lock detect can be set with LD = 10. In this mode, LD is an open-drain output and requires an external pullup resistor of typical value, 10KΩ.

The lock detect output validity is dependent on many factors. The lock detect output is not valid during the VCO auto selection process. After the VCO auto selection process has completed, the lock detect output is not valid until the TUNE voltage has settled. TUNE voltage settling time is dependent on loop filter bandwidth, and can be calculated using the EE-Sim Simulation tool found at www.maximintegrated.com.

Fast-Lock

The device uses a fast-lock mode to decrease lock time. This mode requires that CP = 0000 (register 2, bits 12:9) and that the shunt resistive portion of the loop filter be segmented into two parts, where one resistor (R2A) is 1/4th the total resistance, and the other resistor (R2B) is

3/4th the total resistance. The larger resistor should be connected from SW to ground, and the smaller resistor from SW to the loop filter capacitor. When CDM = 01 (register 3, bits 16:15), fast-lock is active after the VAS has completed. During fast-lock, the charge pump is increased to CP = 1111 and the shunt loop filter resistance is set to 1/4th the total resistance by changing pin SW from high impedance to ground. Fast-lock deactivates after a timeout set by the user. This timeout is loop filter dependent, and is set by:

$$t_{FAST-LOCK} = M \times CDIV / f_{PFD}$$

where M is the modulus setting and CDIV is the clock divider setting. The user must determine the CDIV setting based on their loop filter time constant. The SW pin can be left open/ no connect when fast lock mode is not used.

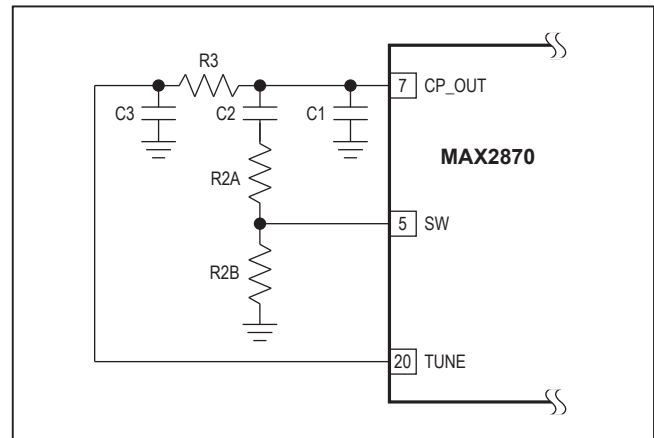

Figure 4. Fast Lock Filter Topology

Table 1. Frac-N Digital Lock-Detect Settings

PFD FREQUENCY	LDS	LDP	LOCKED UP/DOWN TIME SKEW (ns)	NUMBER OF LOCKED CYCLES TO SET LD	UP/DOWNTIME SKEW TO UNSET LD (ns)
≤ 32MHz	0	0	10	40	15
≤ 32MHz	0	1	6	40	15
> 32MHz	1	X	4	40	4

Table 2. Int-N Digital Lock-Detect Settings

PFD FREQUENCY	LDS	LDP	LOCKED UP/DOWN TIME SKEW (ns)	NUMBER OF LOCKED CYCLES TO SET LD	UP/DOWNTIME SKEW TO UNSET LD (ns)
≤ 32MHz	0	0	10	5	15
≤ 32MHz	0	1	6	5	15
> 32MHz	1	X	4	5	4

RFOUTA± and RFOUTB±

The device has dual differential open-collector RF outputs that require an external RF choke 50Ω resistor to supply for each output. Each differential output can be independently enabled or disabled by setting bits RFA_EN (register 4, bit 5) and RFB_EN (register 4, bit 8). Both outputs are also controlled by applying a logic-high (enabled) or logic-low (disabled) to pin RFOUT_EN.

The output power of each output can be individually controlled with APWR (register 4, bits 4:3) for RFOUTA and BPWR (register 4, bits 7:6) for RFOUTB. The available differential output power settings are from -4dBm to +5dBm, in 3dB steps with 50Ω pullup to supply. The available single-ended output power ranges from -4dBm to +5dBm in 3dB steps with a RF choke to supply. Across the entire frequency range different pullup elements (L or R) are required for optimal output power. If the output is used single ended, the unused output should be terminated in a corresponding load.

Voltage-Controlled Oscillator

The fundamental VCO frequency of the device guarantees gap-free coverage from 3.0GHz to 6.0GHz using four individual VCO core blocks with 16 sub-bands within each block. Connect the output of the loop filter to the TUNE input. The TUNE input is used to control the VCO.

Tune ADC

A 3-bit ADC is used to read the VCO tuning voltage. The ADC value can be read back by bits 22:20 in register 6. The ADC uses the ranges shown in [Table 3](#).

Note that the digital or analog lock detect might still be valid when the tuning voltage is out of the compliance range.

VCO Autoselect (VAS) State Machine

An internal VCO autoselect state machine is initiated when register 0 is programmed to automatically select the correct VCO if bit VAS_SHDN = 0 (register 3, bit 25).

The state machine clock, f_{BS} , must be set to 50kHz. This is set by the BS bits. The formula for setting BS is:

$$BS = f_{PFD}/50kHz$$

where f_{PFD} is the phase-detector frequency. The BS (register 4, bits 19:12) value should be rounded to the nearest integer. If the calculated BS is higher than 1023, then set

$BS = 1023$. If f_{PFD} is lower than 50kHz, then set $BS = 1$. The time needed to select the correct VCO is $10/f_{BS}$.

The RETUNE (register 3, bit 24) bit is used to enable or disable the VAS auto-retune function. Should the 3-bit TUNE ADC detect that the VCO control voltage (V_{TUNE}) has drifted into the 000 or 111 state, the VAS will initiate an auto-retune if $RETUNE = 1$. If $RETUNE = 0$, then this function is disabled.

If $VAS_SHDN = 1$, then the VCO can be manually selected by bits VCO (register 3, bits 31:26). Refer to the [Applications Information](#) section for detailed implementation of VCO manual selection.

Phase Shift Mode

After achieving lock, the phase of the MAX2870 device's RF output can be changed in increments of $P/M \times 360^\circ$. The absolute phase cannot be determined, but it can be changed relative to the current phase.

To change the phase, do the following:

- 1) Achieve lock at the desired frequency.
- 2) Set the increment of phase relative to the current phase by setting $P = M \times \{\text{desired_phase_change}\}/360^\circ$.
- 3) Enable the phase change by setting $CDM = 10$.
- 4) Reset $CDM = 00$.

Low-Spur Mode

The device offers three modes for the sigma-delta modulator. Low-noise mode offers lower in-band noise at the expense of spurs. The spurs can be reduced by setting $SDN = 10$ (register 2, bits 30:29) or $SDN = 11$ for different modes of dithering. The user can determine which mode works best for their application.

Table 3. ADC VCO Status

ADC	VCO STATUS
000	Out-of-lock, $V_{TUNE} < 0.5V$
001	In-lock, $0.5V < V_{TUNE} < 0.7V$
010	In-lock, $0.7V < V_{TUNE} < 1.3V$
011	Not used
100	Not used
101	In-lock, $1.3V < V_{TUNE} < 2.1V$
110	In-lock, $2.1V < V_{TUNE} < 2.5V$
111	Out-of-lock, $V_{TUNE} > 2.5V$

Register and Bit Descriptions

The operating mode of the device is controlled by six on-chip registers.

Defaults are not guaranteed upon power-up and are provided for reference only. All reserved bits should only be written with default values. In low-power mode, the register values are retained. Upon power-up, the registers should be programmed twice with at least a 20ms pause between writes. The first write ensures that the device is enabled, and the second write starts the VCO selection process.

Table 4. Register 0 (Address: 000, Default: 007D0000_{HEX})

BIT LOCATION	BIT ID	NAME	DEFINITION
31	INT	Int-N or Frac-N Mode Control	0 = Enables the fractional-N mode 1 = Enables the integer-N mode The LDF bit must also be set to the appropriate mode.
30:15	N[15:0]	Integer Division Value	Sets integer part (N-divider) of the feedback divider factor. All integer values from 16 to 65,535 are allowed for integer mode. Integer values from 19 to 4,091 are allowed for fractional mode.
14:3	FRAC[11:0]	Fractional Division Value	Sets fractional value: 000000000000 = 0 (see F0I bit description) 000000000001 = 1 ---- 111111111110 = 4094 111111111111 = 4095
2:0	ADDR[2:0]	Address Bits	Register address bits 000

Table 5. Register 1 (Address: 001, Default: 200FFF9_{HEX})

BIT LOCATION	BIT ID	NAME	DEFINITION
31	CPOC	CP Output Clamp	Sets charge-pump output clamp mode. 0 = Disables clamping of the CP output when the CP is off 1 = Enables the clamping of the CP output when the CP is off (improved integer-N in-band phase noise)
30:29	CPL[1:0]	CP Linearity	Sets CP linearity mode. 00 = Disables the CP linearity mode (integer-N mode) 01 = Enables the CP linearity mode (frac-N mode) 10 = Reserved 11 = Reserved
28:27	CPT[1:0]	Charge Pump Test	Sets charge-pump test modes. 00 = Normal mode 01 = Reserved 10 = Force CP into source mode 11 = Force CP into sink mode
26:15	P[11:0]	Phase Value	Sets phase value. See the <i>Phase Shift Mode</i> section. 000000000000 = 0 000000000001 = 1 (recommended) ---- 111111111111 = 4095

Table 5. Register 1 (Address: 001, Default: 2000FFF9_{HEX}) (continued)

BIT LOCATION	BIT ID	NAME	DEFINITION
14:3	M[11:0]	Modulus Value (M)	Fractional modulus value used to program fVCO. See the <i>Int, Frac, Mod, and R Counter Relationship</i> section. Double buffered by register 0. 000000000000 = Unused 000000000001 = Unused 000000000010 = 2 ----- 111111111111 = 4095
2:0	ADDR[2:0]	Address Bits	Register address bits 001

Table 6. Register 2 (Address: 010, Default: 00004042_{HEX})

BIT LOCATION	BIT ID	NAME	DEFINITION
31	LDS	Lock-Detect Speed	Lock-detect speed adjustment. 0 = fPFD ≤ 32MHz 1 = fPFD > 32MHz
30:29	SDN[1:0]	Frac-N Noise Mode	Sets noise mode (See the <i>Low-Spur Mode</i> section.) 00 = Low-noise mode 01 = Reserved 10 = Low-spur mode 1 11 = Low-spur mode 2
28:26	MUX[3:0]	MUX_OUT Configuration	Sets MUX_OUT pin configuration (MSB bit located register 05). 0000 = Three-state output 0001 = D_VDD 0010 = D_GND 0011 = R-divider output 0100 = N-divider output/2 0101 = Analog lock detect 0110 = Digital lock detect 0111:1011 = Reserved 1100 = Read register 06 MUX_OUT is configured as serial data out. 1101:1111 = Reserved
25	DBR	Reference Doubler Mode	Sets reference doubler mode. 0 = Disable reference doubler 1 = Enable reference doubler
24	RDIV2	Reference Div2 Mode	Sets reference divider mode. 0 = Disable reference divide-by-2 1 = Enable reference divide-by-2
23:14	R[9:0]	Reference Divider Mode	Sets reference divide value (R). Double buffered by register 0. 0000000000 = 0 (unused) 0000000001 = 1 ----- 1111111111 = 1023

Table 6. Register 2 (Address: 010, Default: 00004042_{HEX}) (continued)

BIT LOCATION	BIT ID	NAME	DEFINITION
13	REG4DB	Double Buffer	Sets double buffer mode. 0 = Disabled 1 = Enabled
12:9	CP[3:0]	Charge-Pump Current	Sets charge-pump current in mA (RSET = 5.1k Ω). Double buffered by register 0. 0000 = 0.32 0001 = 0.64 0010 = 0.96 0011 = 1.28 0100 = 1.60 0101 = 1.92 0110 = 2.24 0111 = 2.56 [ICP = 1.63/RSET x (1 + CP<3:0>)] 1000 = 2.88 1001 = 3.20 1010 = 3.52 1011 = 3.84 1100 = 4.16 1101 = 4.48 1110 = 4.80 1111 = 5.12
8	LDF	Lock-Detect Function	Sets lock-detect function. 0 = Frac-N lock detect 1 = Int-N lock detect
7	LDP	Lock-Detect Precision	Sets lock-detect precision. 0 = 10nS 1 = 6nS
6	PDP	Phase Detector Polarity	Sets phase detector polarity. 0 = Negative (for use with inverting active loop filters) 1 = Positive (for use with passive loop filers and noninverting active loop filters)
5	SHDN	Power-Down Mode	Sets power-down mode. 0 = Normal mode 1 = Device shutdown
4	TRI	Charge-Pump Three-State Mode	Sets charge-pump three-state mode. 0 = Disabled 1 = Enabled
3	RST	Counter Reset	Sets counter reset mode. 0 = Normal operation 1 = R and N counters reset
2:0	ADDR	Address Bits	Register address 010

Table 7. Register 3 (Address: 011, Default: 000000BHEX)

BIT LOCATION	BIT ID	NAME	DEFINITION
31:26	VCO[5:0]	VCO	Manual selection of VCO and VCO sub-band when VAS is disabled. 000000 = VCO0 111111 = VCO63
25	VAS_SHDN	VAS_SHDN	Sets VAS state machine mode. 0 = VAS enabled 1 = VAS disabled
24	RETUNE	RETUNE	Sets VAS response to temperature drift. 0 = VAS auto-retune over temp disabled 1 = VAS auto-retune over temp enabled
23:18	Reserved	Reserved	Reserved. Program to 000000.
17	Reserved	Reserved	Reserved. Program to 0.
16:15	CDM[1:0]	Clock Divider Mode	Sets clock divider mode. 00 = Clock divider off 01 = Fast-lock enabled 10 = Phase mode 11 = Reserved
14:3	CDIV[11:0]	Clock Divider Value	Sets 12-bit clock divider value. 000000000000 = Unused 000000000001 = 1 000000000010 = 2 ----- 111111111111 = 4095
2:0	ADDR[2:0]	Address Bits	Register address 011

Table 8. Register 4 (Address: 100, Default: 6180B23C_{HEX})

BIT LOCATION	BIT ID	NAME	DEFINITION
31:26	Reserved	Reserved	Reserved. Program to 011000.
25:24	BS_MSBs[1:0]	Band-Select MSBs	Band-select MSBs. See bits [19:12].
23	FB	VCO Feedback Mode	Sets VCO to N counter feedback mode. 0 = Divided 1 = Fundamental
22:20	DIVA[2:0]	RFOUT_ Output Divider Mode	Sets RFOUT_ output divider mode. Double buffered by register 0 when REG4DB = 1. 000 = Divide by 1, if 3000MHz ≤ fRFOUTA ≤ 6000MHz 001 = Divide by 2, if 1500MHz ≤ fRFOUTA < 3000MHz 010 = Divide by 4, if 750MHz ≤ fRFOUTA < 1500MHz 011 = Divide by 8, if 375MHz ≤ fRFOUTA < 750MHz 100 = Divide by 16, if 187.5MHz ≤ fRFOUTA < 375MHz 101 = Divide by 32, if 93.75MHz ≤ fRFOUTA < 187.5MHz 110 = Divide by 64, if 46.875MHz ≤ fRFOUTA < 93.75MHz 111 = Divide by 128, if 23.5MHz ≤ fRFOUTA < 46.875MHz
19:12	BS[7:0]	Band Select	Sets band select clock divider value. MSB are located in bits [25:24]. 0000000000 = Reserved 0000000001 = 1 0000000010 = 2 ---- 1111111111 = 1023 See details in VAS section
11	Reserved	Reserved	Reserved. Program to 0.
10	Reserved	Reserved	Reserved. Program to 0.
9	BDIV	RFOUTB Output Path Select	Sets RFOUTB output path select. 0 = VCO divided output 1 = VCO fundamental frequency
8	RFB_EN	RFOUTB Output Mode	Sets RFOUTB output mode. 0 = Disabled 1 = Enabled
7:6	BPWR[1:0]	RFOUTB Output Power	Sets RFOUTB single-ended output power. See the <i>RFOUTA±</i> and <i>RFOUTB±</i> section. 00 = -4dBm 01 = -1dBm 10 = +2dBm 11 = +5dBm
5	RFA_EN	RFOUTA Output Mode	Sets RFOUTA output mode. 0 = Disabled 1 = Enabled
4:3	APWR[1:0]	RFOUTA Output Power	Sets RFOUTA single-ended output power. See the <i>RFOUTA±</i> and <i>RFOUTB±</i> section. 00 = -4dBm 01 = -1dBm 10 = +2dBm 11 = +5dBm
2:0	ADDR[2:0]	Register Address	Register address 100

Table 9. Register 5 (Address: 101, Default: 00400005_{HEX})

BIT LOCATION	BIT ID	NAME	DEFINITION
31:25	Reserved	Reserved	Reserved. Program to 0000000.
24	F01	F01	Sets integer mode for F = 0. 0 = If F[11:0] = 0, then fractional-N mode is set 1 = If F[11:0] = 0, then integer-N mode is auto set
23:22	LD[1:0]	Lock-Detect Pin Function	Sets lock-detect pin function. 00 = Low 01 = Digital lock detect 10 = Analog lock detect 11 = High
21:19	Reserved	Reserved	Reserved. Program to 000.
18	MUX	MUX MSB	Sets mode at MUX_OUT pin (see register 2 [28:26])
17:3	Reserved	Reserved	Reserved. Program to 0000000000000000.
2:0	ADDR[2:0]	Register Address	Register address bits 101

Table 10. Register 6 (Address: 110, Read-Only Register)

BIT LOCATION	BIT ID	NAME	DEFINITION
31:24	—	Reserved	Reserved
23	POR	Power_On_Reset	POR readback status. 0 = POR has been read back 1 = POR has not been read back (registers at default)
22:20	ADC[2:0]	VTUNE_ADC	Reads back the ADC reading of the VTUNE (see the <i>Tune ADC</i> section)
19:9	—	Reserved	Reserved
8:3	V[5:0]	Active VCO	Reads back the current active VCO. 000000 = VCO0 111111 = VCO63
2:0	ADDR[2:0]	Register Address	Register address bits 110

Typical Application Circuit

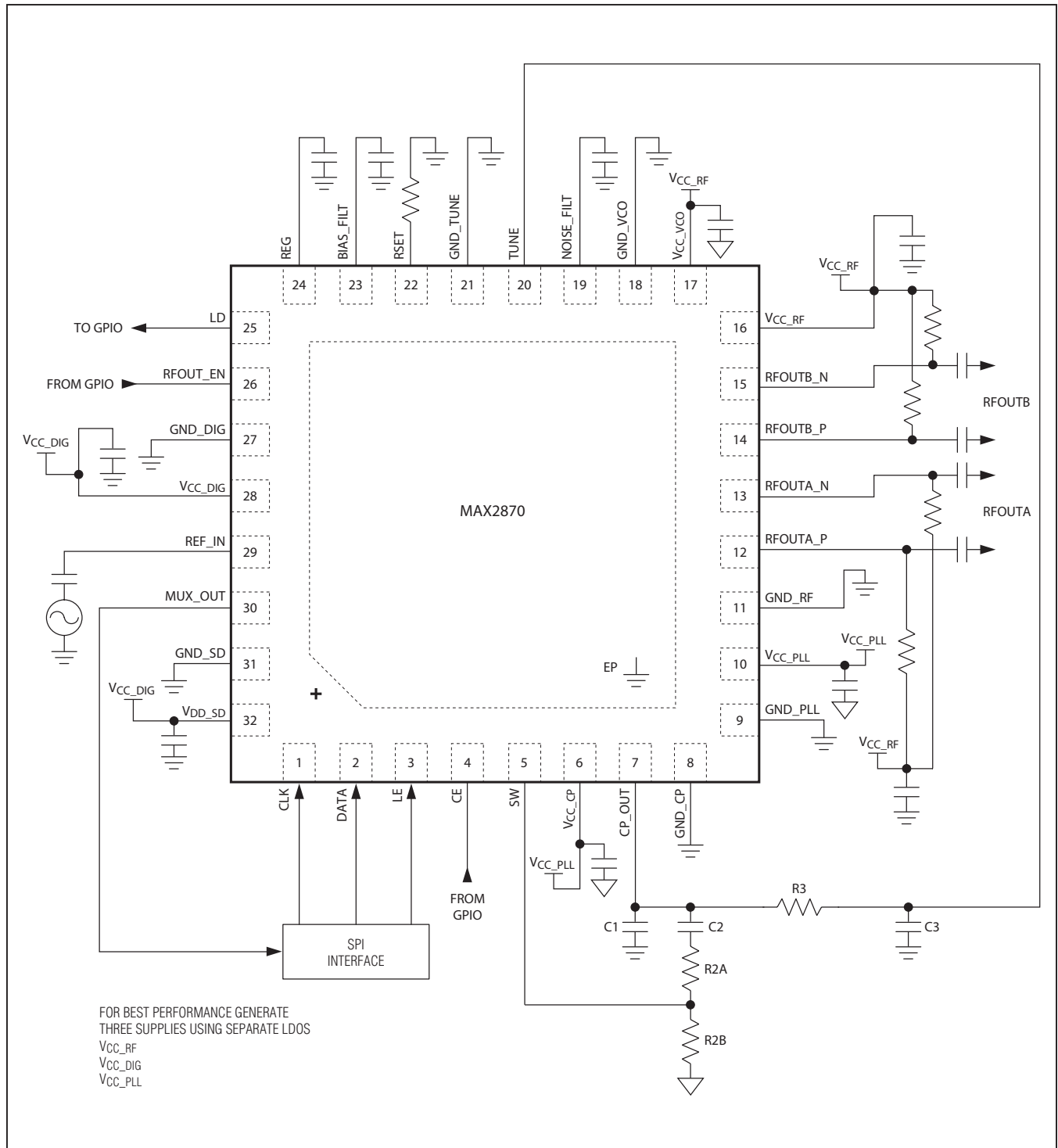

Applications Information

VCO manual selection operation (VAS_SHDN = 1) allows shorter lock time, typically 200 μ Sec saving.

The following steps need to be implemented:

- 1) Building VCO lookup table (Required ONLY once after each power cycle)
 - Set VAS_SHDN = 0, follow “VCO Autoselect (VAS) State Machine” section to set BS bits properly
 - Write proper N and Frac value to Reg 0, triggering MAX2870 to first desired frequency point, i.e freq1. Wait for PLL to lock
 - Read back register 6[8:3] from MUX_OUT pin and save the value to memory as vco1, see detail at 4-Wire Serial Interface section about register read-back
 - Repeat above steps for all desired frequency points
- 2) VCO manual selection normal operation
 - Set VAS_SHDN = 1
 - Based on the VCO lookup table obtained from step 1, write desired frequency’s corresponding VCO value to reg3[31:26]
 - Write proper N and Frac value to reg0, triggering MAX2870 to desired frequency

Ordering Information

PART	TEMP RANGE	PIN-PACKAGE
MAX2870ETJ+	-40°C to +85°C	32 TQFN-EP*

+Denotes a lead(Pb)-free/RoHS-compliant package.

*EP = Exposed pad.

Layout Issues

The MAX2870 EV kit can be used as a starting point for layout. For best performance, take into consideration grounding and routing of RF, baseband, and power supply PCB proper line. Make connections from vias to the ground plane as short as possible. On the high impedance ports, keep traces short to minimize shunt capacitance. EV kit Gerber files can be requested at www.maximintegrated.com.

Power-Supply Layout

To minimize coupling between different sections of the IC, a star power-supply routing configuration with a large decoupling capacitor at a central VCC_ node is recommended. The VCC_ traces branch out from this node, each going to a separate VCC_ node in the circuit. Place a bypass capacitor as close as possible to each supply pin. This arrangement provides local decoupling at each VCC_ pin. Use at least one via per bypass capacitor for a low-inductance ground connection. Do not share the capacitor ground vias with any other branch.

Refer to Maxim’s Wireless and RF Application Notes for more information.

Package Information

For the latest package outline information and land patterns (foot-prints), go to www.maximintegrated.com/packages. Note that a “+”, “#”, or “-” in the package code indicates RoHS status only. Package drawings may show a different suffix character, but the drawing pertains to the package regardless of RoHS status.

PACKAGE TYPE	PACKAGE CODE	OUTLINE NO.	LAND PATTERN NO.
32 TQFN-EP	T3255+5	21-0140	90-0013

Revision History

REVISION NUMBER	REVISION DATE	DESCRIPTION	PAGES CHANGED
0	4/12	Initial release	—
1	7/12	Updated <i>Int, Frac, Mod and R Counter Relationship</i> section; updated formula in <i>VCO Autoselect (VAS) State Machine</i> section, updated Table 8	13, 15, 20
2	11/12	Updated <i>Applications</i> section, Note 3, <i>Typical Operating Characteristics Testing Conditions Table</i> , and Figure 1	1, 4, 7, 12
3	4/13	Updated <i>AC Electrical Characteristics</i> table; updated <i>SPI Characteristics, Pin Description, Fast-Lock</i> , and <i>VCO Autoselect State Machine</i> sections. Replaced Figure 2	3, 4, 11, 12, 14
4	8/13	Updated <i>Fast-Lock</i> Section and <i>Digital I/O Characteristics</i> table	4, 14
5	3/14	Updated the <i>Four-Wire Serial Interface, MUX_OUT and Lock Detect, Register and Bit Descriptions</i> sections, and Table 9	12–16, 21
6	4/17	Added <i>VCO Manual Selection</i> section and other general updates/corrections	1–3, 7–10, 12–24

For pricing, delivery, and ordering information, please contact Maxim Direct at 1-888-629-4642, or visit Maxim Integrated's website at www.maximintegrated.com.

Maxim Integrated cannot assume responsibility for use of any circuitry other than circuitry entirely embodied in a Maxim Integrated product. No circuit patent licenses are implied. Maxim Integrated reserves the right to change the circuitry and specifications without notice at any time. The parametric values (min and max limits) shown in the *Electrical Characteristics* table are guaranteed. Other parametric values quoted in this data sheet are provided for guidance.