



Chipsmall Limited consists of a professional team with an average of over 10 year of expertise in the distribution of electronic components. Based in Hongkong, we have already established firm and mutual-benefit business relationships with customers from,Europe,America and south Asia,supplying obsolete and hard-to-find components to meet their specific needs.

With the principle of "Quality Parts,Customers Priority,Honest Operation,and Considerate Service",our business mainly focus on the distribution of electronic components. Line cards we deal with include Microchip,ALPS,ROHM,Xilinx,Pulse,ON,Everlight and Freescale. Main products comprise IC,Modules,Potentiometer,IC Socket,Relay,Connector.Our parts cover such applications as commercial,industrial, and automotives areas.

We are looking forward to setting up business relationship with you and hope to provide you with the best service and solution. Let us make a better world for our industry!



## Contact us

Tel: +86-755-8981 8866 Fax: +86-755-8427 6832

Email & Skype: info@chipsmall.com Web: www.chipsmall.com

Address: A1208, Overseas Decoration Building, #122 Zhenhua RD., Futian, Shenzhen, China



# MAX3521

# DOCSIS 3.0 Upstream Amplifier

## General Description

The MAX3521 is an integrated CATV upstream amplifier IC designed to exceed the DOCSIS 3.0 requirements. It provides a maximum output power level 3dB higher than the DOCSIS 3.0 specification for all modulation standards and channel configurations. The amplifier covers an 5MHz to 85MHz input frequency range (275MHz, 3dB bandwidth). It is capable of transmitting four QPSK modulated carriers, each at +61dBmV, simultaneously within this range. The gain is controlled in 1dB steps over a 63dB range using an SPI 3-wire interface.

The device operates from a single +5V supply. Four power codes are provided to allow maximum supply current to be reduced as determined by distortion requirements. In addition, for each power code, supply current is automatically reduced as gain is reduced while maintaining distortion performance. The supply current drops to 5mA between bursts to minimize power dissipation in transmit-disable mode. Control signal logic levels are 3.3V CMOS.

The MAX3521 is the most recent addition to Maxim's pin-compatible cable upstream amplifier family, which includes the MAX3518. The MAX3521 is available in a 20-pin TQFN package and operates over the extended industrial temperature range (-40°C to +85°C).

## Benefits and Features

- +5V Supply Voltage
- Ultra-Low 25mW Dissipation in Transmit-Disable Mode
- 63dB Gain-Control Range in 1dB Steps
- -65dBc Harmonic Distortion at 67dBmV Output
- Small 5mm x 5mm TQFN Package
- Low Burst On/Off Transient
- 275MHz, 3dB Bandwidth
- Multiple Power Modes for Optimal Battery Life

## Applications

- DOCSIS 3.0 Plus Cable Modems and Gateways
- VOIP Modems
- Set-Top Boxes

*Ordering Information* appears at end of data sheet.

*Typical Application Circuit* appears at end of data sheet.

## Functional Diagram

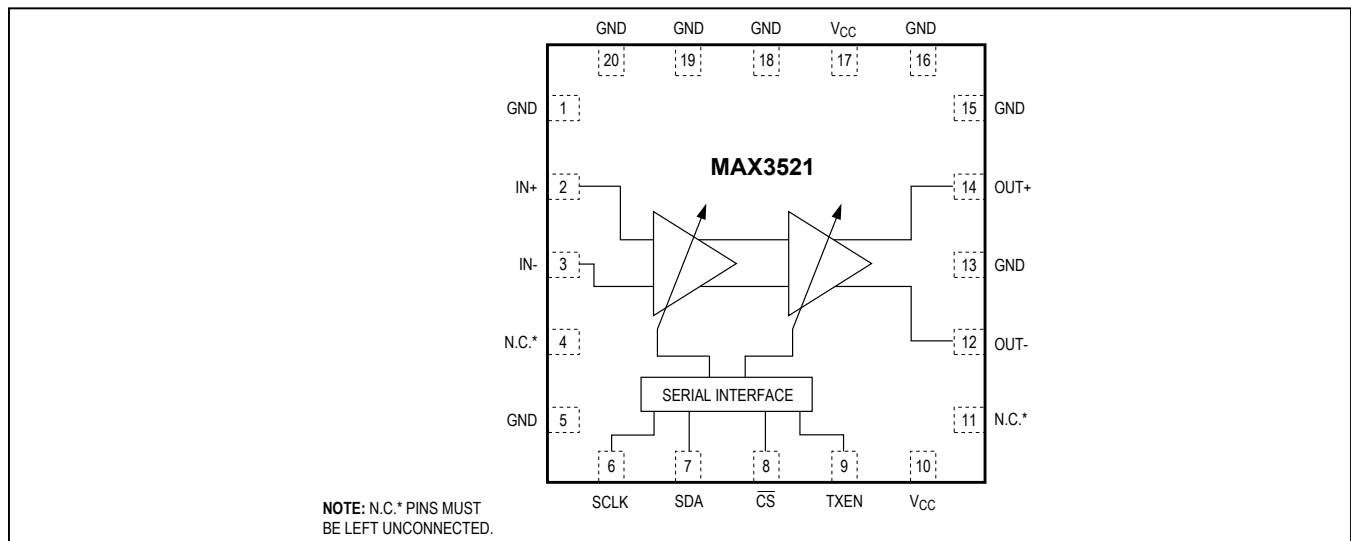

### Absolute Maximum Ratings

V <sub>CC</sub> to GND .....	-0.3V to +5.5V	Operating Temperature Range.....	-40°C to +85°C
IN+, IN-.....	-0.3V to (V <sub>CC</sub> + 0.3V)	Junction Temperature.....	+150°C
OUT+, OUT-.....	-0.3V to (V <sub>CC</sub> + 3.6V)	Storage Temperature Range.....	-65°C to +165°C
TXEN, SDA, SCLK, CS.....	-0.3V to +4.2V	Lead Temperature (soldering, 10s).....	+300°C
RF Input Power .....	+10dBm	Soldering Temperature (reflow).....	+260°C
Continuous Power Dissipation (T <sub>A</sub> = +70°C)			
(derate 34.5mW/°C above T <sub>A</sub> = +70°C).....	2750mW		

Stresses beyond those listed under "Absolute Maximum Ratings" may cause permanent damage to the device. These are stress ratings only, and functional operation of the device at these or any other conditions beyond those indicated in the operational sections of the specifications is not implied. Exposure to absolute maximum rating conditions for extended periods may affect device reliability.

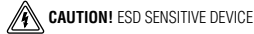

### DC Electrical Characteristics

(Typical Application Circuit as shown, V<sub>CC</sub> = 4.75V to 5.25V, V<sub>GND</sub> = 0V, TXEN = high, T<sub>A</sub> = -40°C to +85°C, unless otherwise specified. Typical values are at V<sub>CC</sub> = 5V, T<sub>A</sub> = +25°C.) (Note 1)

PARAMETER	SYMBOL	CONDITIONS	MIN	TYP	MAX	UNITS
Supply Voltage	V <sub>CC</sub>		4.75		5.25	V
Supply Current Transmit Mode	I <sub>CC</sub>	Gain code = 61, power code = 3 (34dB gain typ)		475	495	mA
		Gain code = 61, power code = 2 (34dB gain typ)		430	450	
		Gain code = 58, power code = 1 (31dB gain typ)		310		
Supply Current Transmit Disable Mode	I <sub>CC</sub>	TXEN = low		5	6.5	mA
Input High Voltage	V <sub>INH</sub>		2.0		3.6	V
Input Low Voltage	V <sub>INL</sub>				0.7	V
Input High Current	I <sub>BIASH</sub>				10	μA
Input Low Current	I <sub>BIASL</sub>		-10			μA

### AC Electrical Characteristics

(Typical Application Circuit as shown, V<sub>CC</sub> = 4.75V to 5.25V, V<sub>GND</sub> = 0V, TXEN = high, T<sub>A</sub> = -40°C to +85°C, unless otherwise specified. Typical values are at V<sub>CC</sub> = 5V, T<sub>A</sub> = +25°C.) (Note 1)

PARAMETER	SYMBOL	CONDITIONS	MIN	TYP	MAX	UNITS
Frequency Range	f <sub>IN</sub>	(Note 2)	5		85	MHz
Voltage Gain, Z <sub>IN</sub> = 200Ω, Z <sub>OUT</sub> = 75Ω, Power Code = 3 (Notes 3, 4)	A <sub>V</sub>	Gain code = 63	35	36	37	dB
		Gain code = 53	25	26	27	
		Gain code = 43	15	16	17	
		Gain code = 33	5	6	7	
		Gain code = 23	-5	-4	-3	
		Gain code = 13	-15	-14	-13	
		Gain code = 03	-25	-24	-23	

### AC Electrical Characteristics (continued)

(Typical Application Circuit as shown,  $V_{CC} = 4.75V$  to  $5.25V$ ,  $V_{GND} = 0V$ , TXEN = high,  $T_A = -40^{\circ}C$  to  $+85^{\circ}C$ , unless otherwise specified. Typical values are at  $V_{CC} = 5V$ ,  $T_A = +25^{\circ}C$ .) (Note 1)

PARAMETER	SYMBOL	CONDITIONS	MIN	TYP	MAX	UNITS
Voltage Gain Variation with Power Code, Any Gain Code				±0.1		dB
Gain Rolloff		Voltage gain = -25dB to +36dB, $f_{IN} = 5MHz$ to 85MHz		-0.3		dB
Gain Step Size		Voltage gain = -23dB to +36dB, $f_{IN} = 5MHz$ to 85MHz	0.7	1.0	1.3	dB
Transmit-Disable Mode Noise		Any BW = 160kHz from 5MHz to 85MHz, TXEN = low, voltage gain = -24dB to +36dB (Note 5)		-66		dBmV
Isolation in Transmit-Disable Mode		TXEN = low		80		dB
Noise Figure	NF	Transmit mode, voltage gain = +13dB to +36dB (Note 5)			11	dB
Noise Figure Slope		Transmit mode, voltage gain = -24dB to +36dB		-1.0		dB/dB
Transmit-Disable/Transmit-Enable Transient Duration		TXEN input rise/fall time < 0.1µs		2		µs
Transmit-Disable/Transmit-Enable Transient Step Size		Gain = 36dB		35	80	mV <sub>P-P</sub>
		Gain = 4dB		1		
Input Impedance	$Z_{IN}$	Balanced		200		Ω
Input Return Loss		200Ω system		15		dB
Output Return Loss		75Ω system (Note 5)	9.6	11		dB
Output Return Loss in Transmit-Disable Mode		75Ω system, TXEN = low (Note 5)	9.6	11		dB
2nd Harmonic Distortion	HD2	Input tone at 33dBmV, $V_{OUT} = +67dBmV$ , power code = 3 (Note 5)		-69	-55	dBc
3rd Harmonic Distortion	HD3	Input tone at 33dBmV, $V_{OUT} = +67dBmV$ , power code = 3 (Note 5)		-65	-57	dBc
Two-Tone 2nd-Order Distortion	IM2	Input tones at 30dBmV, $V_{OUT} = +64dBmV/$ tone, power code = 3 (Note 5)		-67	-57	dBc
Two-Tone 3rd-Order Distortion	IM3	Input tones at 30dBmV, $V_{OUT} = +64dBmV/$ tone, power code = 3 (Note 5)		-61	-53	dBc
4-Channel 64QAM Distortion		4 adjacent input channels at +27dBmV/ch, $V_{OUT} = +61dBmV/$ ch, power code =3, channel bandwidth = 1280kHz, channel spacing = 1600kHz, upper extent of highest frequency channel is 42MHz (Note 6)		-50		dBc
		4 adjacent input channels at +26dBmV/ch, $V_{OUT} = +60dBmV/$ ch, power code = 3, channel bandwidth = 1280kHz, channel spacing = 1600kHz, upper extent of highest frequency channel is 85MHz (Note 6)		-50		

## AC Electrical Characteristics (continued)

(Typical Application Circuit as shown,  $V_{CC} = 4.75V$  to  $5.25V$ ,  $V_{GND} = 0V$ , TXEN = high,  $T_A = -40^{\circ}C$  to  $+85^{\circ}C$ , unless otherwise specified. Typical values are at  $V_{CC} = 5V$ ,  $T_A = +25^{\circ}C$ .) (Note 1)

PARAMETER	SYMBOL	CONDITIONS	MIN	TYP	MAX	UNITS
8-Channel 64QAM Distortion		8 adjacent input channels at +23dBmV/ch, $V_{OUT} = +57dBmV/ch$ , power code = 3, channel bandwidth = 1280kHz, channel spacing = 1600kHz, upper extent of highest frequency channel is 42MHz (Note 6)		-50		dBc
		8 adjacent input channels at +22dBmV/ch, $V_{OUT} = +56dBmV/ch$ , power code = 3, channel bandwidth = 1280kHz, channel spacing = 1600kHz, upper extent of highest frequency channel is 85MHz (Note 6)		-50		
Output 1dB Compression Point	$P_{1dB}$	Gain = 36dB, power code = 3		76		dBmV

## Timing Characteristics

(Typical Application Circuit as shown,  $V_{CC} = 4.75V$  to  $5.25V$ ,  $V_{GND} = 0V$ ,  $T_A = -40^{\circ}C$  to  $+85^{\circ}C$ , unless otherwise specified. Typical values are at  $V_{CC} = 5V$ ,  $T_A = +25^{\circ}C$ .) (Note 1)

PARAMETER	SYMBOL	CONDITIONS	MIN	TYP	MAX	UNITS
SEN to SCLK Rise Setup Time	$t_{SENS}$			20		ns
SEN to SCLK Rise Hold Time	$t_{SENH}$			10		ns
SDA to SCLK Setup Time	$t_{SDAS}$			20		ns
SDA to SCLK Hold Time	$t_{SDAH}$			10		ns
SCLK Pulse-Width High	$t_{SCLKH}$			50		ns
SCLK Pulse-Width Low	$t_{SCLKL}$			50		ns
Maximum SCLK Frequency			10			MHz

**Note 1:** Min/max values are production tested at  $T_A = +85^{\circ}C$ . Min/max limits at  $T_A = -40^{\circ}C$  and  $T_A = +25^{\circ}C$  are guaranteed by design and characterization.

**Note 2:** Production tested at 10MHz and 85MHz.

**Note 3:** Voltage gain does not include loss due to input transformer.

**Note 4:** Production tested at 42MHz.

**Note 5:** Guaranteed by design and characterization.

**Note 6:** Distortion is measured in the first adjacent channel above or below the active array. The total distortion power in the adjacent channel is integrated and then specified relative to the integrated power of one of the active channels.

**Typical Operating Characteristics**

(MAX3521 EV kit,  $V_{CC} = +5V$ ,  $V_{IN} = 33dBmV$ ,  $f_{IN} = 42MHz$ ,  $Z_{LOAD} = 75\Omega$ , power code = 3, gain code = 61,  $T_A = +25^\circ C$ , unless otherwise noted.)

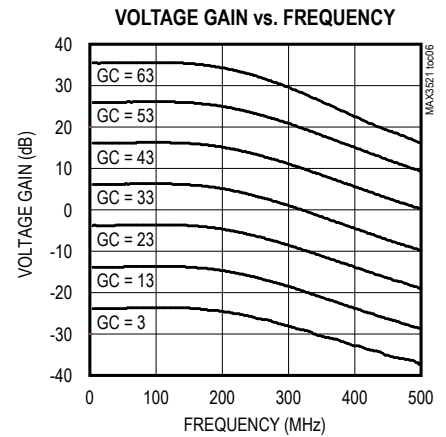
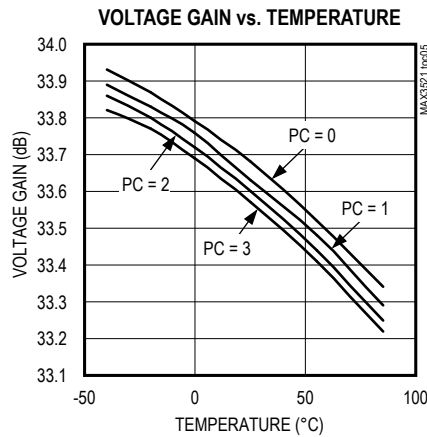
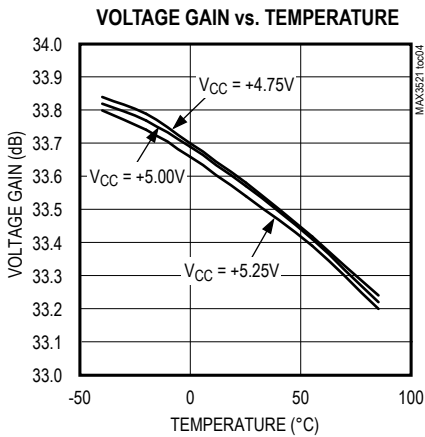
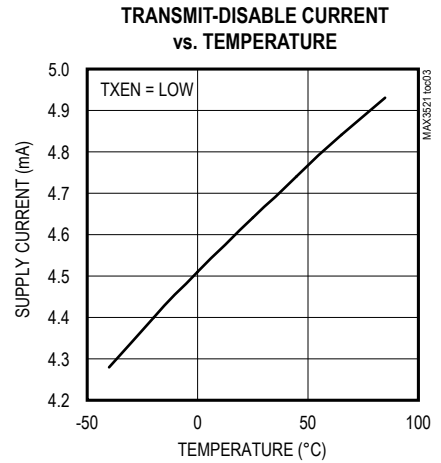
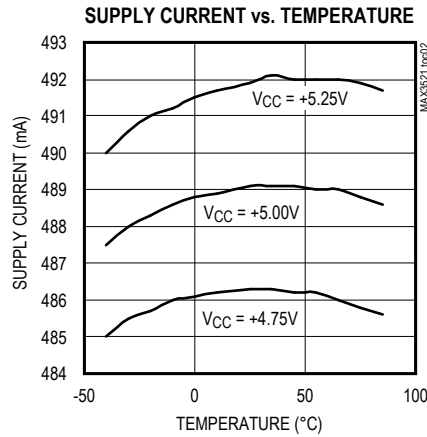
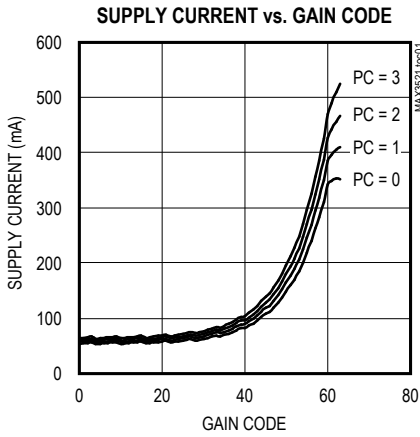

Typical Operating Characteristics (continued)

(MAX3521 EV kit,  $V_{CC} = +5V$ ,  $V_{IN} = 33dBmV$ ,  $f_{IN} = 42MHz$ ,  $Z_{LOAD} = 75\Omega$ , power code = 3, gain code = 61,  $T_A = +25^\circ C$ , unless otherwise noted.)

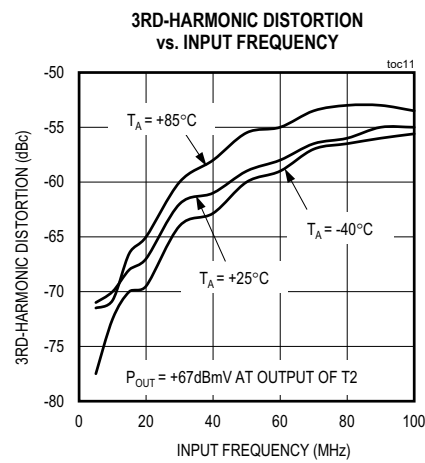
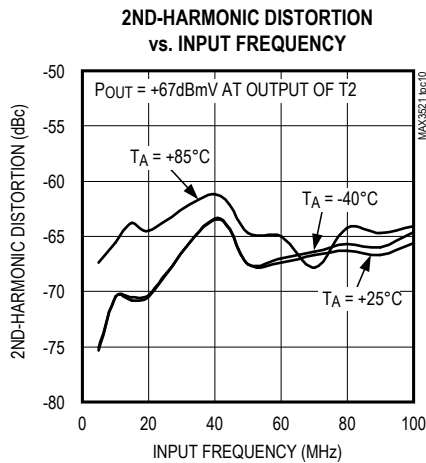
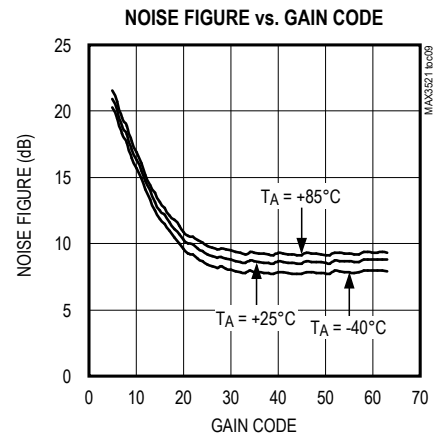
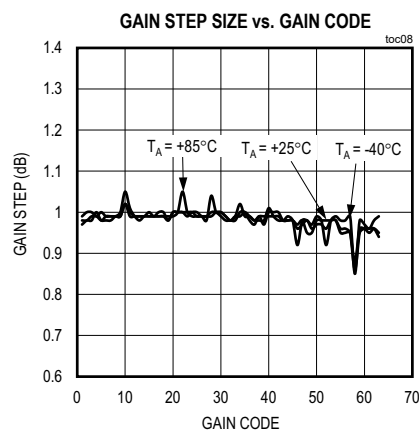
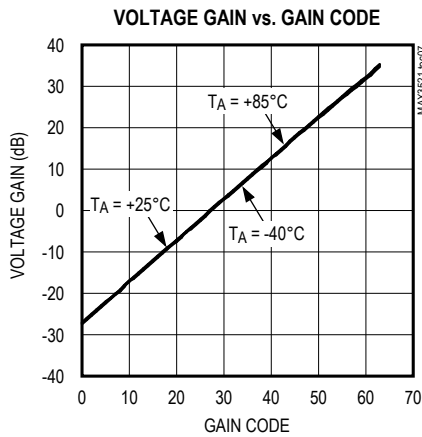

Typical Operating Characteristics (continued)

(MAX3521 EV kit,  $V_{CC} = +5V$ ,  $V_{IN} = 33dBmV$ ,  $f_{IN} = 42MHz$ ,  $Z_{LOAD} = 75\Omega$ , power code = 3, gain code = 61,  $T_A = +25^\circ C$ , unless otherwise noted.)

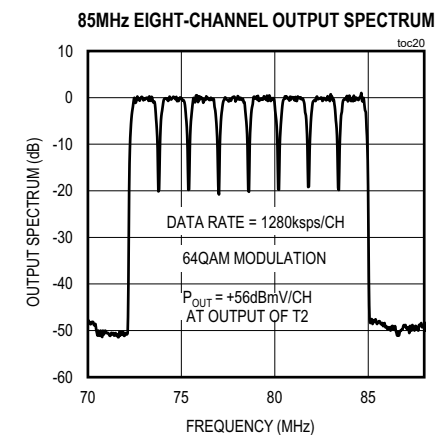
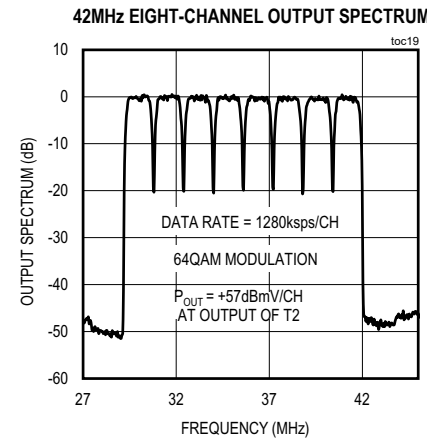
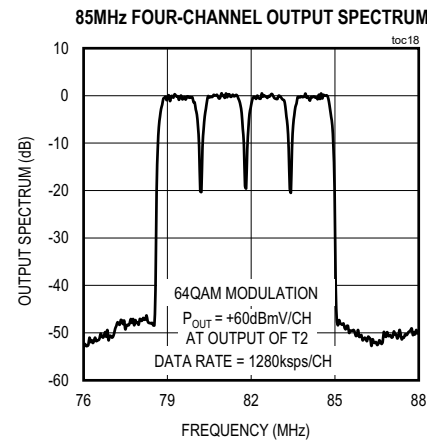
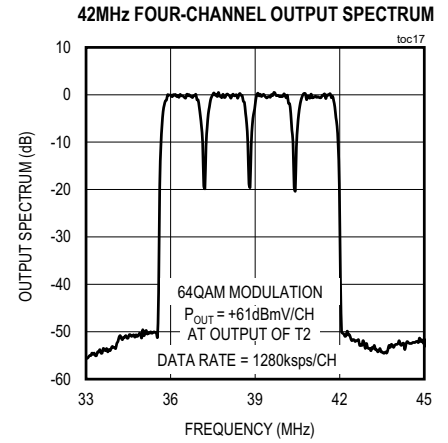
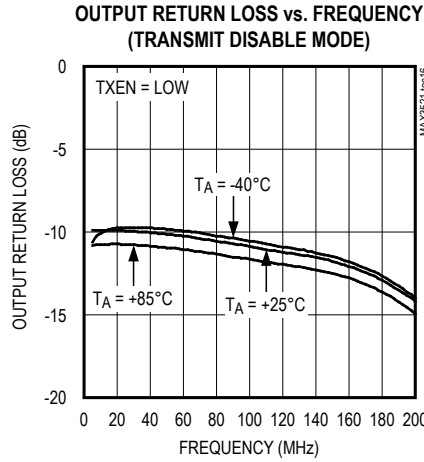
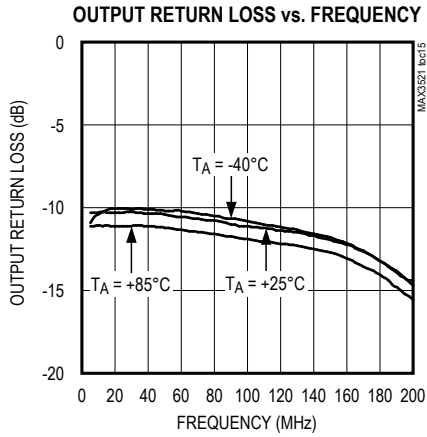
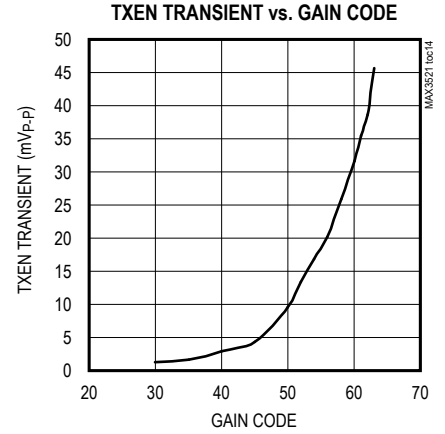
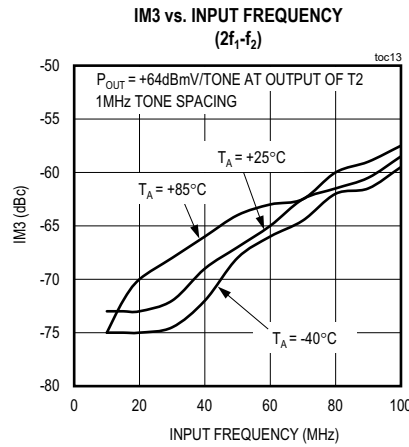
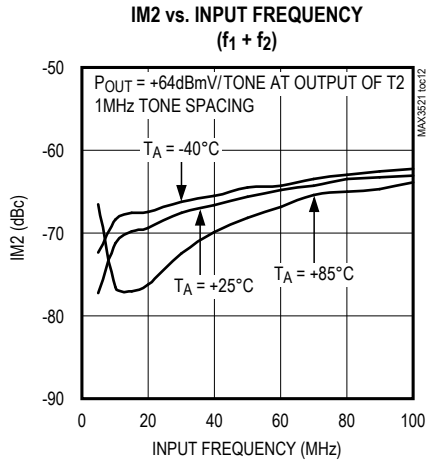



### Pin Configuration

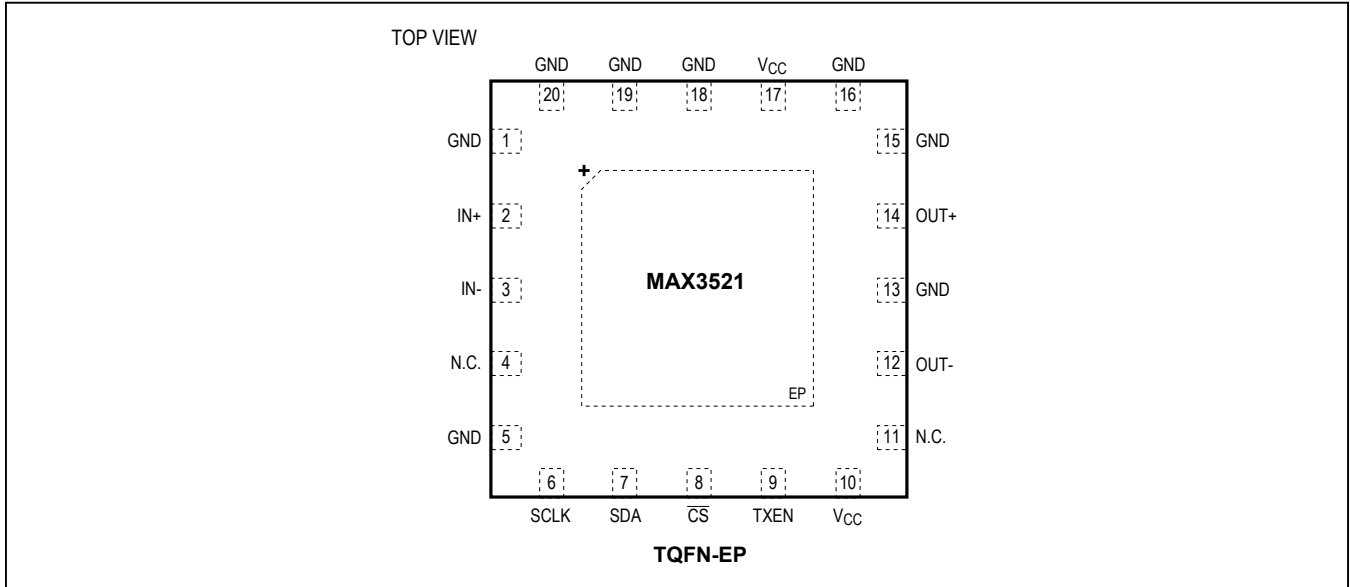

### Pin Description

PIN	NAME	FUNCTION
1, 5, 13, 15, 16, 18-20	GND	Ground
2	IN+	Positive PGA Input
3	IN-	Negative PGA Input
4, 11	N.C.	No Connection. These pins must remain open.
6	SCLK	Serial Interface Clock
7	SDA	Serial Interface Data
8	CS	Serial Interface Enable
9	TXEN	Transmit Enable. TXEN = high places the device in transmit mode.
10	V <sub>CC</sub>	Supply Voltage for Serial Interface
12	OUT-	Negative Output
14	OUT+	Positive Output
17	V <sub>CC</sub>	Supply Voltage for Programmable-Gain Amplifier (PGA)
—	EP	Exposed Pad. Connect EP to ground.

## Detailed Description

### Programmable-Gain Amplifier

The programmable-gain amplifier (PGA) provides 63dB of output level control in 1dB steps. The gain of the PGA is determined by a 6-bit gain code (GC5–GC0) programmed through the serial-data interface (Tables 1 and 2). Specified performance is achieved when the input is driven differentially.

Four power codes (PC1–PC0) allow the PGA to be used with reduced bias current when distortion performance can be relaxed. In addition, for each power code, bias current is automatically reduced with gain code for maximum efficiency.

The PGA features a differential Class A output stage capable of driving four +61dBmV QPSK modulated signals, or a single +67dBmV QPSK modulated signal into a 75Ω load. This architecture provides superior even-order distortion performance but requires that a transformer be used to convert to a single-ended output. In transmit-disable mode, the output amplifiers are powered down, resulting in low output noise while maintaining the impedance match.

### 3-Wire Serial Interface (SPI) and Control Registers

The MAX3521 includes two programmable registers for initializing the part and setting the gain and power consumption. The four MSBs are address bits; the eight least significant bits (LSBs) are used for register data. Data is shifted MSB first.

**Note:** The registers must be written no earlier than 100μs after the device is powered up. Once a new set of register data is clocked in, the corresponding power code and/or gain code does not take effect until  $\overline{CS}$  transitions from low to high.

## Applications Information

### Power Codes

The device is designed to exceed the stringent linearity requirements of DOCSIS 3.0 using power code (PC) 3. For DOCSIS 2.0, PC = 1 is recommended, which results in substantial supply current reduction. The full range of gain codes can be used in any power code. The gain difference between power codes is typically less than 0.1dB.

**Table 1. Register Description**

REGISTER NAME	REGISTER ADDRESS	DATA 8 BITS							
		B7	B6	B5	B4	B3	B2	B1	B0
Power/Gain	0000	PC1	PC0	GC5	GC4	GC3	GC2	GC1	GC0
Initialize	0001	0	0	1	0	0	0	0	0

**Table 2. Power/Gain Register (0x0)**

BIT NAME	BIT LOCATION (0 = LSB)	RECOMMENDED DEFAULT	FUNCTION
PC[1:0]	7, 6	11	Sets the power code, which controls the bias current drawn by the device in transmit mode: 11 - PC = 3, maximum current draw. . . . 00 - PC = 0, minimum current draw. (See the <i>Typical Operating Characteristics</i> .)
GC[5:0]	5–0	11 1111	Sets the gain code, which determines the voltage gain of the amplifier: 11 1111 - GC = 63, voltage gain = 36dB (typ). 11 1110 - GC = 62, voltage gain = 35dB (typ). . . . 00 0011 - GC = 03, voltage gain = -24dB (typ). (See the <i>AC Electrical Characteristics</i> .)

**Table 3. Initialize Register (0x1)**

BIT NAME	BIT LOCATION (0 = LSB)	RECOMMENDED DEFAULT	FUNCTION
—	7–0	0010 0000	Must be programmed to 0010 0000 upon power-up for specified performance.

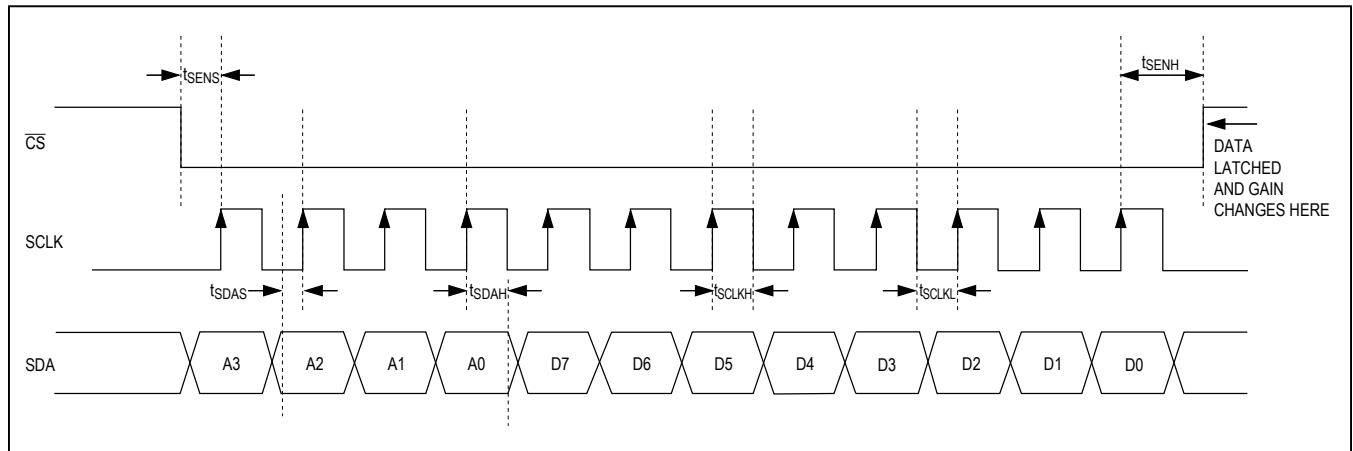

Figure 1. SPI 3-Wire Interface Timing Diagram

**Transmit-Disable Mode**

Between bursts in a DOCSIS system, the device should be put in transmit-disable mode by setting TXEN low. The output transient on the cable is kept well below the DOCSIS requirement during the TXEN transitions.

If a gain or power change is required, new values of PC and GC should be clocked in during transmit-disable mode (TXEN low). The new operating point of the device is set when CS transitions high during the time between bursts.

**Output Transformer**

The output circuit is an open-collector differential amplifier. The output should be terminated with a pair 37.4Ω resistors in parallel with 10pF capacitors connected between OUT+ and OUT- and the center tap of the output transformer. A 1:2 impedance ratio transformer should be used as the interface between the differential output of the device and the unbalanced 75Ω load. The 1:2 impedance ratio has been chosen to reduce the peak differential voltage observed between OUT+ and OUT-, while ensuring that maximum power is transferred to the load.

The transformer must have adequate bandwidth to cover the intended application. Note that some RF transformers specify bandwidth with a 50Ω source on the primary and a matching resistance on the secondary winding. Operating in a 75Ω system tends to shift the low-frequency edge of the transformer bandwidth specification up by a factor of

1.5 due to primary inductance. Keep this in mind when specifying a transformer.

Bias to the output stage is provided through the center tap on the transformer primary. This greatly diminishes the on/off transients present at the output when switching between transmit and transmit-disable modes. Commercially available transformers typically have adequate balance between half-windings to achieve substantial transient cancellation.

Finally, keep in mind that transformer core inductance varies with temperature. Adequate primary inductance must be present to sustain broadband output capability as temperatures vary.

**Input Circuit**

To achieve the rated performance, the inputs of the device must be driven differentially with an appropriate input level. The differential input impedance is 200Ω. Most applications require an anti-alias filter preceding the device. The filter should be designed to match this 200Ω impedance.

The device has sufficient gain and linearity to produce an output level of +67dBmV when driven with a +33dBmV QPSK input signal. If an input level greater than +33dBmV is used, the 3rd-order distortion performance degrades slightly.

## Layout Issues

A well-designed printed circuit board (PCB) is an essential part of an RF circuit. For best performance, pay attention to power-supply layout issues as well as the output circuit layout. The MAX3521 EV board layout can be utilized as a guide during PCB design. Its electrical performance has been thoroughly tested, making it an excellent reference. Refer to the MAX3521 EV Kit documentation for additional information.

### No Connect Pins

Pins 4 and 11 must be left open, not connected to supply or ground or any other node in the circuit.

### Output Circuit Layout

The differential implementation of the output has the benefit of significantly reducing even-order distortion, the most significant of which is 2nd-harmonic distortion. The degree of distortion cancellation depends on the amplitude and phase balance of the overall circuit. It is important to keep the trace lengths from the output pins equal.

### Power-Supply Layout

For minimal coupling between different sections of the IC, the ideal power-supply layout is a star configuration. This configuration has a large-value decoupling capaci-

tor at the central power-supply node. The power-supply traces branch out from this node, each going to a separate power-supply node in the circuit. At the end of each of these traces is a decoupling capacitor that provides a very low impedance at the frequency of interest. This arrangement provides local power-supply decoupling at each power-supply pin. The power-supply traces must be capable of carrying the maximum current without significant voltage drop.

The output transformer center tap node, VCC\_CT, must be connected to the supply through a ferrite bead. Connect a decoupling capacitor between the center tap and GND.

### Exposed Pad Thermal Considerations

The exposed pad (EP) of the MAX3521's 20-pin TQFN package provides a low thermal resistance path to the die. It is important that the PCB on which the device is mounted be designed to conduct heat from this contact. In addition, the EP should be provided with a low-inductance path to electrical ground. The MAX3521 EV board is an example of a layout that provides optimal thermal and electrical performance. It is recommended that the EP be soldered to a ground plane on the PCB, either directly or through an array of plated via holes.

Typical Application Circuit

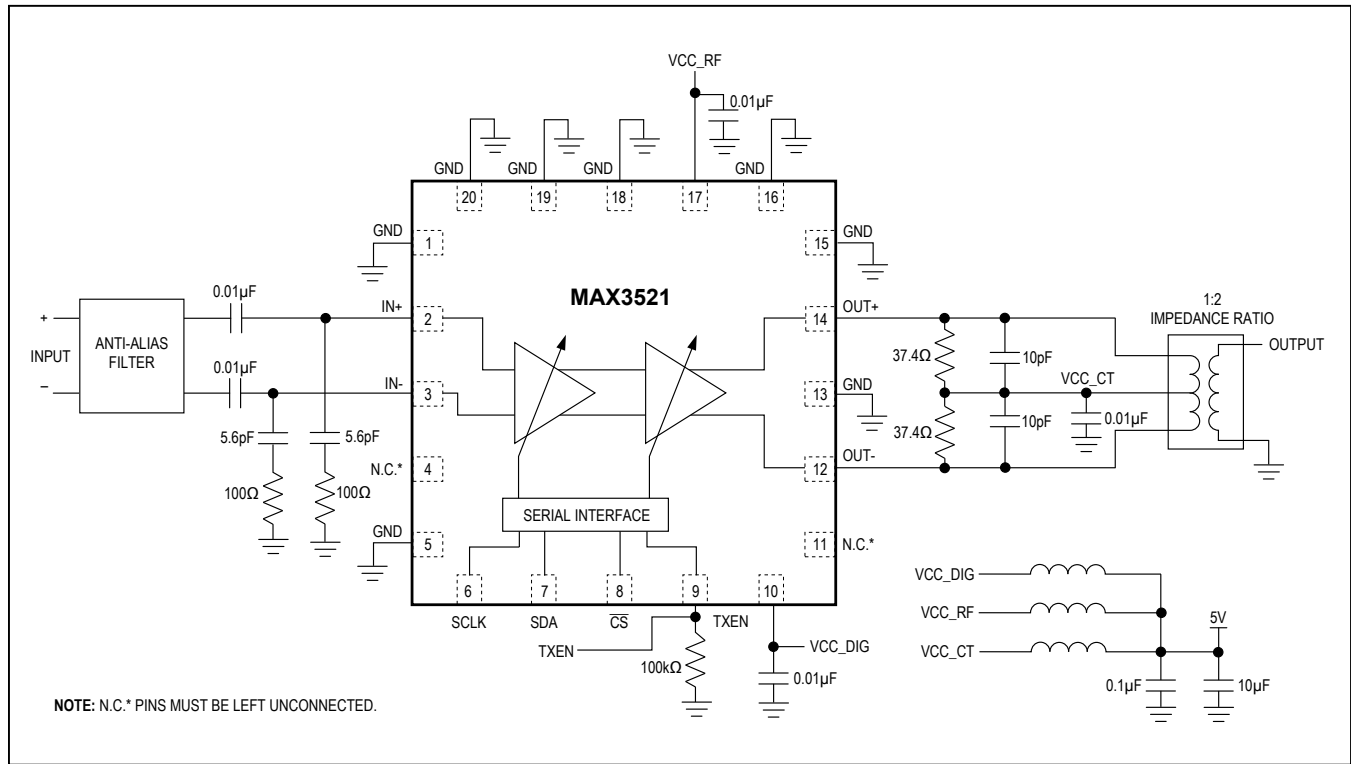

Ordering Information

PART	TEMP RANGE	PIN-PACKAGE
MAX3521ETP+	-40°C to +85°C	20 TQFN-EP*

+Denotes a lead(Pb)-free/RoHS-compliant package.  
 \*EP = Exposed pad.

Package Information

For the latest package outline information and land patterns (footprints), go to [www.maximintegrated.com/packages](http://www.maximintegrated.com/packages). Note that a "+", "#", or "-" in the package code indicates RoHS status only. Package drawings may show a different suffix character, but the drawing pertains to the package regardless of RoHS status.

PACKAGE TYPE	PACKAGE CODE	OUTLINE NO.	LAND PATTERN NO.
20 TQFN-EP	T2055+5	<a href="#">21-0140</a>	<a href="#">90-0010</a>

## Revision History

REVISION NUMBER	REVISION DATE	DESCRIPTION	PAGES CHANGED
0	9/12	Initial release	—
1	4/13	Updated <i>AC Electrical Characteristics</i> table	3
2	12/13	Updated <i>AC Electrical Characteristics</i> table, <i>Typical Operating Characteristics</i> , and <i>Typical Application Circuit</i>	3–7, 12
3	9/17	Updated <i>General Description</i> section	1

For pricing, delivery, and ordering information, please visit Maxim Integrated's online storefront at <https://www.maximintegrated.com/en/storefront/storefront.html>.

Maxim Integrated cannot assume responsibility for use of any circuitry other than circuitry entirely embodied in a Maxim Integrated product. No circuit patent licenses are implied. Maxim Integrated reserves the right to change the circuitry and specifications without notice at any time. The parametric values (min and max limits) shown in the *Electrical Characteristics* table are guaranteed. Other parametric values quoted in this data sheet are provided for guidance.