



Chipsmall Limited consists of a professional team with an average of over 10 year of expertise in the distribution of electronic components. Based in Hongkong, we have already established firm and mutual-benefit business relationships with customers from,Europe,America and south Asia,supplying obsolete and hard-to-find components to meet their specific needs.

With the principle of "Quality Parts,Customers Priority,Honest Operation,and Considerate Service",our business mainly focus on the distribution of electronic components. Line cards we deal with include Microchip,ALPS,ROHM,Xilinx,Pulse,ON,Everlight and Freescale. Main products comprise IC,Modules,Potentiometer,IC Socket,Relay,Connector.Our parts cover such applications as commercial,industrial, and automotives areas.

We are looking forward to setting up business relationship with you and hope to provide you with the best service and solution. Let us make a better world for our industry!



Contact us

Tel: +86-755-8981 8866 Fax: +86-755-8427 6832

Email & Skype: info@chipsmall.com Web: www.chipsmall.com

Address: A1208, Overseas Decoration Building, #122 Zhenhua RD., Futian, Shenzhen, China





Multiband Digital Television Tuner

MAX3544

General Description

The MAX3544 broadband single-conversion television tuner is designed for use in digital (DVB-T, DVB-C, GB20600) television sets and terrestrial receivers. It receives all television bands from 47MHz to 862MHz and converts the selected channel to an industry-standard 36MHz IF.

The MAX3544 includes a variable-gain low-noise input amplifier; an RF tracking filter; an image rejection mixer; a peak detector; an optional internal, self-contained RF gain-control loop (RFAGC); a VCO with fractional-N PLL; an IF bandpass filter; an IF variable-gain amplifier; and a crystal oscillator.

The MAX3544 is available in a small, 6mm x 6mm, thin QFN package, and the application circuit fits in 20mm x 25mm on a two-layer board with single-sided component mounting.

Applications

DVB-T/DVB-T2 DTMB/GB20600
 DVB-C ATSC

Features

- ◆ Standard IF Architecture Ensures < -70dBc Spurs
- ◆ Integrated RF Tracking Filter
- ◆ Integrated IF Bandpass Filter
- ◆ Full-Band Coverage (47MHz to 862MHz)
- ◆ 70dB Image Rejection
- ◆ 4dB Noise Figure
- ◆ Fast-Locking, Low Phase-Noise PLL Supports 256QAM
- ◆ Crystal Oscillator and Buffer/Divider to Drive Baseband IC
- ◆ 745mW Power Dissipation

Ordering Information

| PART | TEMP RANGE | PIN-PACKAGE |
|-------------|--------------|-------------|
| MAX3544CTL+ | 0°C to +70°C | 40 TQFN-EP* |

+ Denotes a lead(Pb)-free/RoHS-compliant package.
 *EP = Exposed paddle.

Block Diagram/Typical Application Circuit/Pin Configuration

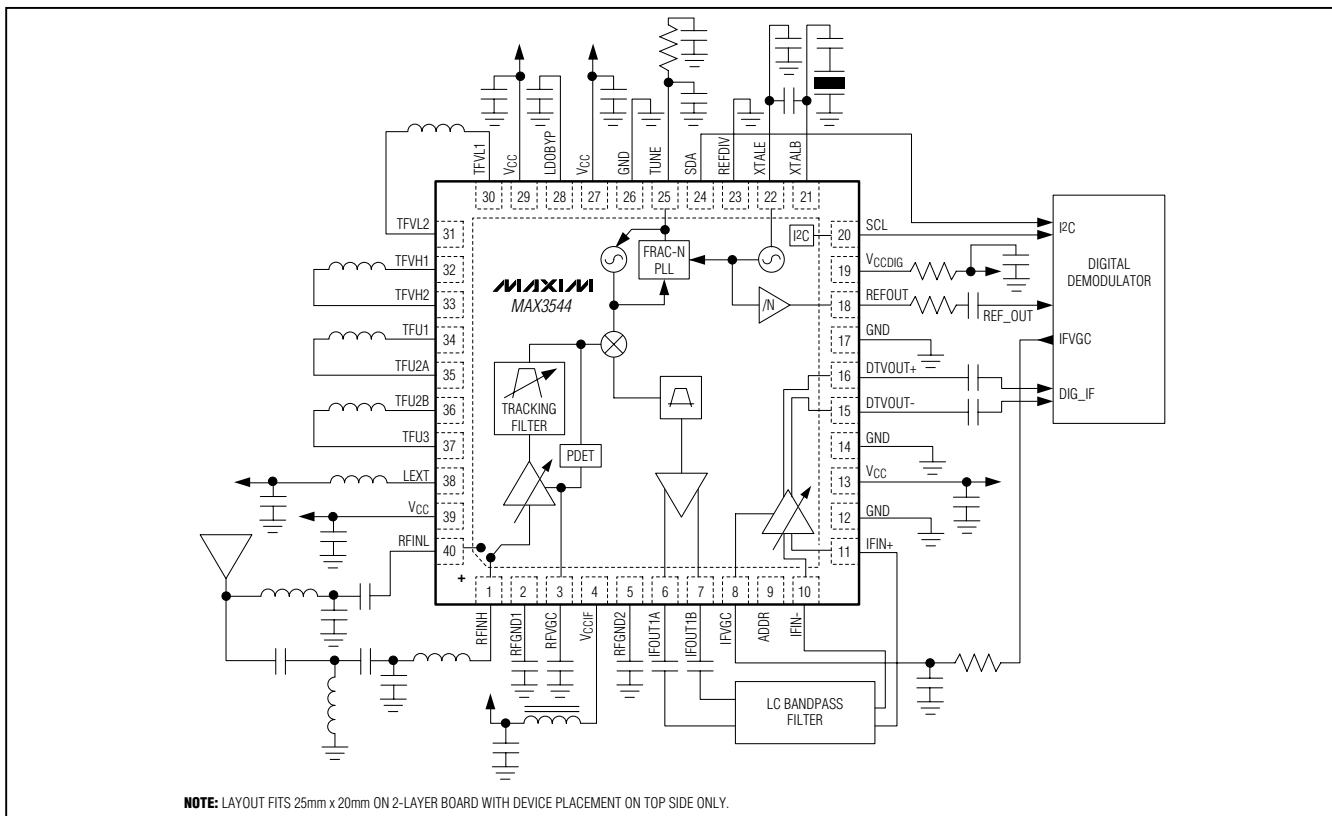

Multiband Digital Television Tuner

ABSOLUTE MAXIMUM RATINGS

| | | | |
|--|-----------------------------------|--|-----------------|
| V _{CC} to GND..... | -0.3V to +3.6V | Continuous Power Dissipation (T _A = +70°C) (derate 35.7mW/°C above +70°C)..... | 2857mW |
| RFINL, RFINH, IFIN+, IFIN-, DTVOUT+, DTVOUT-, IFOUT1A, IFOUT1B..... | -0.3V to (V _{CC} + 0.3V) | Operating Temperature Range..... | 0°C to +70°C |
| SDA, SCLK, IFAGC, RFVGA..... | -0.3V to +3.6V | Junction Temperature..... | +150°C |
| Short-Circuit Protection: DTVOUT+, DTVOUT-, IFOUT1A, IFOUT1B..... | Indefinite | Storage Temperature Range..... | -65°C to +165°C |
| RF Input Power..... | +10dBm | Lead Temperature (soldering, 10s)..... | +300°C |
| | | Soldering Temperature (reflow)..... | +260°C |

Stresses beyond those listed under "Absolute Maximum Ratings" may cause permanent damage to the device. These are stress ratings only, and functional operation of the device at these or any other conditions beyond those indicated in the operational sections of the specifications is not implied. Exposure to absolute maximum rating conditions for extended periods may affect device reliability.

DC ELECTRICAL CHARACTERISTICS

(MAX3544 Evaluation Kit, V_{CC} = 3.1V to 3.5V, T_A = 0°C to +70°C, registers set according to Table 1. Typical values are at V_{CC} = 3.3V, T_A = +25°C, unless otherwise noted.) (Note 1)

| PARAMETER | CONDITIONS | MIN | TYP | MAX | UNITS |
|-----------------------------------|--|------------------------|--------------|-----------------------|-------|
| SUPPLY VOLTAGE AND CURRENT | | | | | |
| Supply Voltage | | 3.1 | | 3.5 | V |
| Supply Current | IF VGA enabled | | 225 | 270 | mA |
| | Standby (REF oscillator on) R08[7] = 1 | | 5 | | |
| RF and IF VGC Input Bias Current | At 0.5V to 3.0V DC | | -100 to +100 | | μA |
| RF and IF VGC Control Voltage | Maximum gain | 3.0 | | | V |
| RF and IF VGC Control Voltage | Minimum gain | | | 0.5 | V |
| SERIAL INTERFACE | | | | | |
| Input Logic-Level Low | | | | 0.3 x V _{CC} | V |
| Input Logic-Level High | | 0.7 x V _{CC} | | | V |
| Output Logic-Level Low | 3mA sink current | | | 0.4 | V |
| Output Logic-Level High | | V _{CC} - 0.5V | | | V |
| Maximum Clock Rate | | 400 | | | kHz |

AC ELECTRICAL CHARACTERISTICS

(MAX3544 Evaluation Kit, RF center frequency = 666MHz, IF center frequency = 36.15MHz, registers set according to Table 1, f_{REF} = 16MHz, V_{RFVGC} = V_{IFVGC} = 3.0V, V_{CC} = 3.3V, T_A = +25°C, unless otherwise noted.)

| PARAMETER | CONDITIONS | MIN | TYP | MAX | UNITS |
|---|--------------------------|-----|-----|-----|-------|
| OVERALL REQUIREMENTS (RF INPUT TO IF OUTPUT) | | | | | |
| RFINL Operating Frequency Range | Tunable frequency range | 47 | | 345 | MHz |
| RFINH Operating Frequency Range | Tunable frequency range | 345 | | 862 | MHz |
| Maximum Voltage Gain to IFOUT1 | DVB-T mode (see Table 1) | | 50 | | dB |

Multiband Digital Television Tuner

MAX3544

AC ELECTRICAL CHARACTERISTICS (continued)

(MAX3544 Evaluation Kit, RF center frequency = 666MHz, IF center frequency = 36.15MHz, registers set according to Table 1, $f_{REF} = 16\text{MHz}$, $V_{RFVGC} = V_{IFVGC} = 3.0\text{V}$, $V_{CC} = 3.3\text{V}$, $T_A = +25^\circ\text{C}$, unless otherwise noted.)

| PARAMETER | CONDITIONS | MIN | TYP | MAX | UNITS |
|---|---|------------------|-------|------------|-------|
| RF Gain Control Range | (gain at $V_{RFVGC} = 3.0\text{V}$) - (gain at $V_{RFVGC} = 0.5\text{V}$) | | 53 | | dB |
| Noise Figure | | | 4 | | dB |
| Image Rejection | Image applied at 77.8MHz above desired channel's center frequency | 47MHz to 470MHz | > 70 | | dB |
| | | 470MHz to 862MHz | > 65 | | |
| IF VARIABLE-GAIN AMPLIFIER | | | | | |
| Maximum Voltage Gain | Output load impedance > $2\text{k}\Omega \parallel 3\text{pF}$, differential load | | 60 | | dB |
| Minimum Voltage Gain | Output load impedance > $2\text{k}\Omega \parallel 3\text{pF}$, differential load, $V_{IFVGC} = 0.5\text{V}$ | | 19 | | dB |
| In-Channel Output V1dB | 36.15MHz CW output signal | | > 2.5 | | VP-P |
| DETECTOR | | | | | |
| Wideband Detector Input-Referred Attack Point | Programmable, $R0B[6:4] = 100$, CW input signal | | -36 | | dBm |
| Narrowband Detector Input-Referred Attack Point | Programmable, $R0B[2:0] = 011$, CW input signal | | -47 | | dBm |
| SIGMA-DELTA FRAC-N SYNTHESIZER | | | | | |
| N-Divider Value | | 19 | | 251 | |
| Fractional-N Resolution | | | 20 | | Bits |
| Phase-Detector Frequency | $f_{XTAL}/2$ | 8 | | 10.5 | MHz |
| Phase-Detector Frequency | $f_{XTAL}/1$ | 16 | | 21 | MHz |
| REFERENCE OSCILLATOR | | | | | |
| Frequency | (Note 2) | 16 | | 32 | MHz |
| External Overdrive Level | AC-coupled sine-wave input | 0.5 | | 1.5 | VP-P |
| REFERENCE OSCILLATOR OUTPUT BUFFER | | | | | |
| Output Frequency | /1, /4 modes | 4 | 4 | f_{XTAL} | MHz |
| Output Level | Load Impedance > $20\text{k}\Omega \parallel 3\text{pF}$ | | 1.1 | | VP-P |

Note 1: Guaranteed by production test at $+25^\circ\text{C}$. 0°C and $+70^\circ\text{C}$ are guaranteed by design and characterization.

Note 2: Guaranteed by design and characterization.

Multiband Digital Television Tuner

Typical Register Summary

Table 1 shows register settings to configure the MAX3544 for operation with a 16MHz crystal frequency and 666MHz RF frequency with a differential LC bandpass filter.

Table 1. Typical Register Settings

| REGISTER NAME | REGISTER ADDRESS | REGISTER FUNCTION | DVB-T MODE, 8MHz DIFFERENTIAL IF (hex) |
|---------------|------------------|--------------------------|--|
| R00 | 0x00 | VCO | 4C |
| R01 | 0x01 | NDIV INT | 2B |
| R02 | 0x02 | NDIV FRAC2 | 8E |
| R03 | 0x03 | NDIV FRAC1 | 26 |
| R04 | 0x04 | NDIV FRAC0 (VAS Trigger) | 66 |
| R05 | 0x05 | MODE CTRL | D8 |
| R06 | 0x06 | TFS | Calculated from ROM values |
| R07 | 0x07 | TFP | Calculated from ROM values |
| R08 | 0x08 | SHUTDOWN | 00 |
| R09 | 0x09 | REF CONFIG | 0A |
| R0A | 0x0A | VAS CONFIG | 16 |
| R0B | 0x0B | PWRDET CFG1 | 43 |
| R0C | 0x0C | PWRDET CFG2 | 01 |
| R0D | 0x0D | FILT CF ADJ | Read from ROM |
| R0E | 0x0E | ROM ADDR | 00 |
| R0F | 0x0F | IRHR | Read from ROM |
| R10 | 0x10 | ROM READBACK | Read only |
| R11 | 0x11 | VAS STATUS | Read only |
| R12 | 0x12 | GEN STATUS | Read only |
| R13 | 0x13 | BIAS ADJ | 56 |
| R14 | 0x14 | TEST1 | 40 |
| R15 | 0x15 | ROM WRITE DATA | Maxim use only |

Multiband Digital Television Tuner

Typical Operating Characteristics

(MAX3544 Evaluation Kit, $V_{CC} = 3.3V$, $T_A = +25^\circ C$, registers set according to Table 1, unless otherwise noted.)

MAX3544

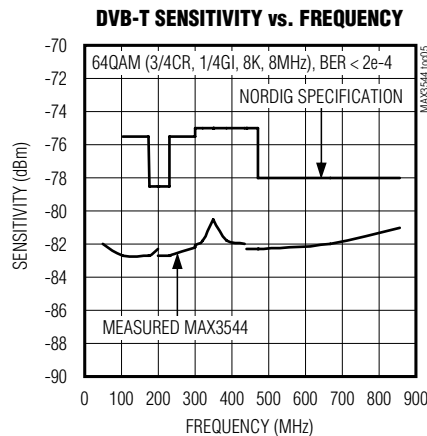
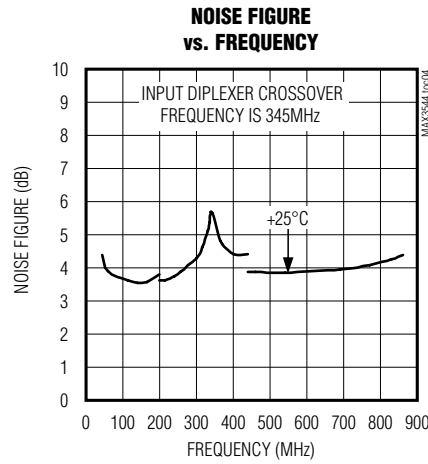
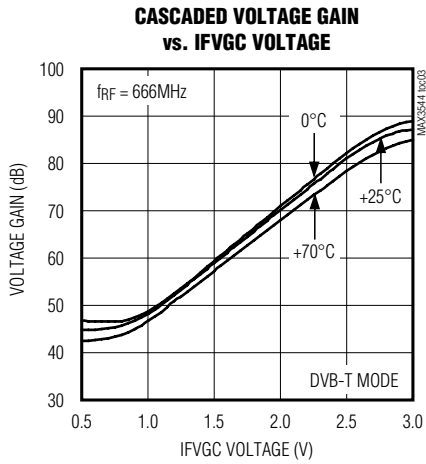
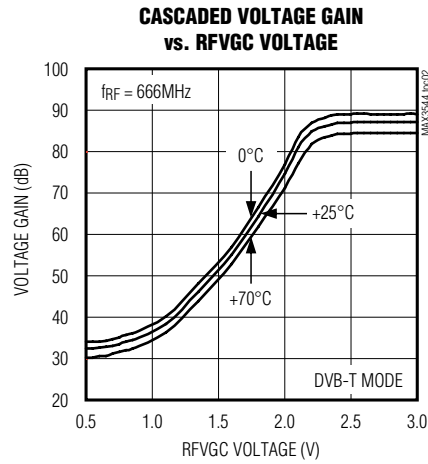
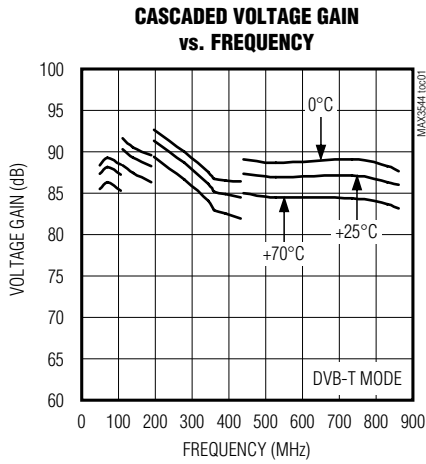

Multiband Digital Television Tuner

Typical Operating Characteristics (continued)

(MAX3544 Evaluation Kit, $V_{CC} = 3.3V$, $T_A = +25^\circ C$, registers set according to Table 1, unless otherwise noted.)

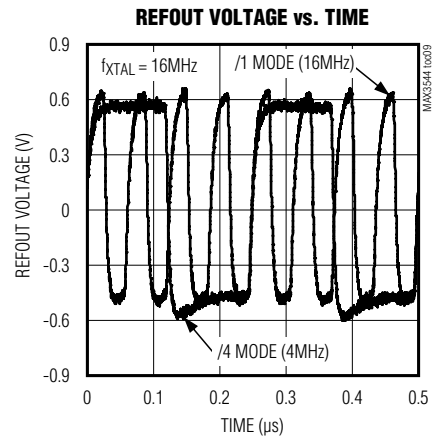
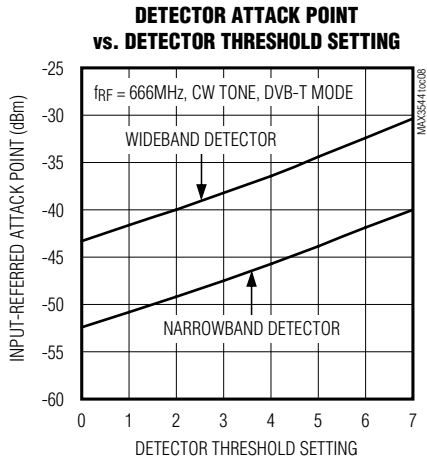
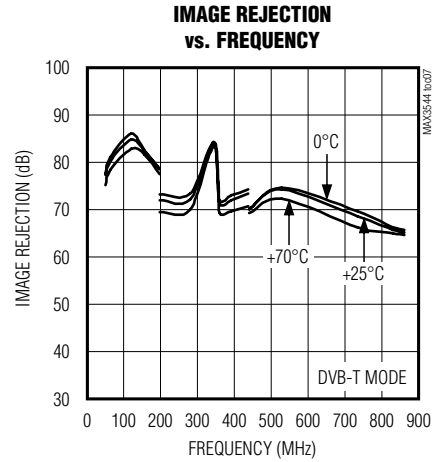
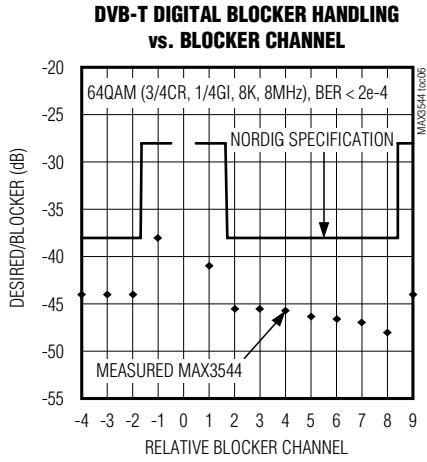

Multiband Digital Television Tuner

Pin Description

MAX3544

| PIN | NAME | FUNCTION |
|----------------|------------------|---|
| 1 | RFINH | High-Frequency RF Input. Matched to 75Ω over the operating band. Requires a DC-blocking capacitor. |
| 2 | RFGND1 | RF Ground. Bypass to the PCB's ground plane with a 1000pF capacitor. Keep traces as short as possible to minimize inductance to ground plane. Do not connect RFGND1 and RFGND2 together. |
| 3 | RFVGC | RF VGA Gain Control Voltage. Accepts a DC voltage from 0.5V to 3V. |
| 4 | VCCIF | IF Power Supply. Requires a 600Ω series ferrite bead to a bypass capacitor to ground. |
| 5 | RFGND2 | RF Ground. Bypass to the PCB's ground plane with a 1000pF capacitor. Keep traces as short as possible to minimize inductance to ground plane. Do not connect RFGND1 and RFGND2 together. |
| 6 | IFOUT1A | Dual-Mode IF Output. In single-ended mode, this pin is the IF signal output. In differential mode, this pin is the positive terminal of the differential IF output. |
| 7 | IFOUT1B | Dual-Mode IF Output. In single-ended mode, this pin is the SAW filter bandwidth switch. In differential mode, this pin is the negative terminal of the differential IF output. |
| 8 | IFVGC | IF VGA Gain Control Voltage. Accepts a DC voltage from 0.5V to 3V. |
| 9 | ADDR | 2-Wire Serial-Interface Address Line. This pin sets the device address for the I ² C-compatible serial interface. There are three selectable addresses based on the state of this pin: logic-low, logic-high, or unconnected. |
| 10, 11 | IFIN-, IFIN+ | Differential IF VGA Input. Connect to the IF filter output. |
| 12, 14, 17, 26 | GND | Ground. Connect pin to paddle ground to minimize trace inductance. |
| 13, 27, 29, 39 | VCC | Power-Supply Connections. Bypass each supply pin with a separate 1000pF capacitor to ground. |
| 15, 16 | DTVOUT-, DTVOUT+ | Differential IF VGA Output. Connect to the demodulator input. Requires a 1000pF DC-blocking capacitor. |
| 18 | REFOUT | Crystal Output to Drive Baseband IC. Output frequency is f _X TAL or f _X TAL/4. |
| 19 | VCCDIG | Digital Supply. Requires a 15Ω series resistor to a 1μF bypass capacitor. |
| 20 | SCL | 2-Wire Serial Clock Interface. Connect to the serial bus and ensure the bus includes an approximately 5kΩ pullup resistor. |
| 21 | XTALB | Crystal Oscillator Base. Connect to the crystal through a DC-blocking capacitor and connect a capacitor to XTALE. |
| 22 | XTALE | Crystal Oscillator Emitter. Connect a capacitor to ground and a capacitor to XTALB. |
| 23 | REFDIV | Reference Frequency Divider Control. Three modes are available depending on the state of this pin: high = f _X TAL/1, low = f _X TAL/4, unconnected = state determined by register. Note: Power-up state of register is not guaranteed; therefore, unconnected mode should only be used if the controller can reprogram I²C in any of the divider settings. |
| 24 | SDA | 2-Wire Serial Data Interface. Connect to serial bus and ensure the bus includes an approximately 5kΩ pullup resistor. |
| 25 | TUNE | PLL Charge-Pump Output and TUNE Input. Connect to the PLL loop filter. |
| 28 | LDOBYP | Bypass for On-Chip VCO LDO. Bypass to ground with a 0.47μF capacitor. |

Multiband Digital Television Tuner

Pin Description (continued)

| PIN | NAME | FUNCTION |
|-----|----------|---|
| 30 | TFVL1* | VHF Low Tracking Filter 1 |
| 31 | TFVL2* | VHF Low Tracking Filter 2 |
| 32 | TFVH1* | VHF High Tracking Filter 1 |
| 33 | TFVH2* | VHF High Tracking Filter 2 |
| 34 | TFU1* | UHF Tracking Filter 1 |
| 35 | TFU2A* | UHF Tracking Filter 2A |
| 36 | TFU2B* | UHF Tracking Filter 2B |
| 37 | TFU3* | UHF Tracking Filter 3 |
| 38 | LEXT* | RF VGA Supply Voltage. Connect through a 270nH pullup inductor to V _{CC} . |
| 40 | RFINL | Low-Frequency RF Input. Matched to 75Ω over the operating band. Requires a DC-blocking capacitor. |
| — | EP (GND) | Exposed Paddle Ground. Solder evenly to the PCB ground plane for proper operation. |

*Improper placement of these inductors degrades image rejection, gain, and noise figure. Copy Maxim reference design layout exactly in this area.

Detailed Description

I²C-Compatible Serial Interface

The MAX3544 uses a 2-wire I²C-compatible serial interface consisting of a serial data line (SDA) and a serial clock line (SCL). SDA and SCL facilitate bidirectional communication between the MAX3544 and the master at clock frequencies up to 400kHz. The master initiates a data transfer on the bus and generates the SCL signal to permit data transfer. The MAX3544 behaves as a slave device that transfers and receives data to and from the master. Pull SDA and SCL high with external pullup resistors for proper bus operation.

One bit is transferred during each SCL clock cycle. A minimum of nine clock cycles is required to transfer a byte in or out of the MAX3544 (8 data bits and an ACK/NACK). The data on SDA must remain stable during the high period of the SCL clock pulse. Changes in SDA while SCL is high and stable are considered control signals (see the *START* and *STOP Conditions* section). Both SDA and SCL remain high when the bus is not busy.

START and STOP Conditions

The master initiates a transmission with a START condition (S), which is a high-to-low transition on SDA while SCL is high. The master terminates a transmission with a STOP condition (P), which is a low-to-high transition on SDA while SCL is high.

Acknowledge and Not-Acknowledge Conditions

Data transfers are framed with an acknowledge bit (ACK) or a not-acknowledge bit (NACK). Both the master and the MAX3544 (slave) generate acknowledge bits. To generate an acknowledge, the receiving device must pull SDA low before the rising edge of the acknowledge-related clock pulse (ninth pulse) and keep it low during the high period of the clock pulse.

To generate a not-acknowledge condition, the receiver allows SDA to be pulled high before the rising edge of the acknowledge-related clock pulse, and leaves SDA high during the high period of the clock pulse. Monitoring the acknowledge bits allows for detection of unsuccessful data transfers. An unsuccessful data transfer happens if a receiving device is busy or if a system fault has occurred. In the event of an unsuccessful data transfer, the bus master must reattempt communication at a later time.

Slave Address

The MAX3544 has a 7-bit slave address plus one R/ \bar{W} bit. These 8 bits must be sent to the device following a START condition to initiate communication. The slave address is determined by the state of the ADDR pin as shown in Table 2.

Table 2. Address Configurations

| ADDR PIN | ADDR2 | ADDR1 | WRITE ADDRESS | READ ADDRESS |
|-------------|-------|-------|---------------|--------------|
| 0 | 0 | 0 | 0xC0 | 0xC1 |
| Unconnected | 0 | 1 | 0xC2 | 0xC3 |
| 1 | 1 | 0 | 0xC4 | 0xC5 |

Multiband Digital Television Tuner

MAX3544

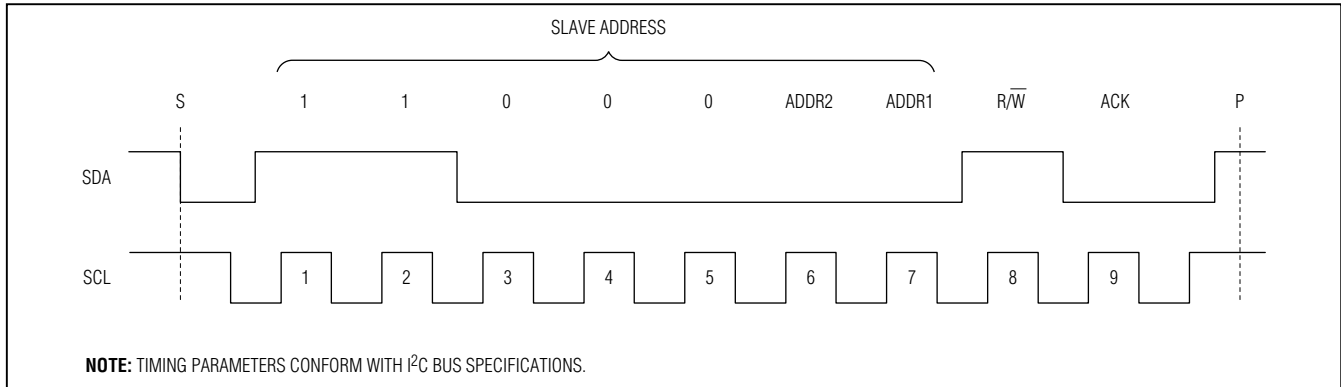

Figure 1. MAX3544 Slave Address Byte. Example shows read address 0x0C1 (ADDR pin grounded).

The MAX3544 continuously awaits a START condition followed by its slave address. When the device recognizes its slave address, it acknowledges by pulling the SDA line low for one clock period; it is ready to accept or send data depending on the R/W bit (Figure 1).

Write Cycle

When addressed with a write command, the MAX3544 allows the master to write to a single register or to multiple successive registers.

A write cycle begins with the bus master issuing a START condition followed by the 7 slave address bits and a write bit ($R/\bar{W} = 0$). The MAX3544 issues an ACK if the slave address byte is successfully received. The bus master must then send to the slave the address of the first register it wishes to write to. If the slave acknowledges the address, the master can then write 1 byte to the register at the specified address. Data is written beginning with the most significant bit. The MAX3544 again issues an ACK if the data is successfully written to the register. The master can continue to write data to the successive internal registers with the MAX3544 acknowledging each successful transfer, or it can terminate transmission by issuing a STOP condition. The write cycle does not terminate until the master issues a STOP condition.

Figure 2 illustrates an example in which registers 0, 1, and 2 are written with 0x0E, 0xD8, and 0xE1, respectively.

Read Cycle

A read cycle begins with the bus master issuing a START condition followed by the 7 slave address bits and a write bit ($R/\bar{W} = 0$). The MAX3544 issues an ACK if the slave address byte is successfully received. The master then sends the 8-bit address of the first register that it wishes to read. The MAX3544 then issues another ACK. Next, the master must issue a START condition followed by the 7 slave address bits and a read bit ($R/\bar{W} = 1$). The MAX3544 issues an ACK if it successfully recognizes its address and begins sending data from the specified register address starting with the most significant bit (MSB). Data is clocked out of the MAX3544 on the rising edge of SCL. On the ninth rising edge of SCL, the master can issue an ACK and continue reading successive registers or it can issue a NACK followed by a STOP condition to terminate transmission. The read cycle does not terminate until the master issues a STOP condition. Figure 3 illustrates an example in which registers 0 and 1 are read back.

| START | WRITE DEVICE ADDRESS | R/ \bar{W} | ACK | WRITE REGISTER ADDRESS | ACK | WRITE DATA TO REGISTER 0x00 | ACK | WRITE DATA TO REGISTER 0x01 | ACK | WRITE DATA TO REGISTER 0x02 | ACK | STOP |
|-------|----------------------|--------------|-----|------------------------|-----|-----------------------------|-----|-----------------------------|-----|-----------------------------|-----|------|
| | 11000[ADDR2][ADDR1] | 0 | — | 0x00 | — | 0x0E | — | 0xD8 | — | 0xE1 | — | |

Figure 2. Example: Write registers 0, 1, and 2 with 0x0E, 0xD8, and 0xE1, respectively.

| START | WRITE DEVICE ADDRESS | R/ \bar{W} | ACK | WRITE 1ST REGISTER ADDRESS | ACK | START | WRITE DEVICE ADDRESS | R/ \bar{W} | ACK | READ DATA REG 0 | ACK | READ DATA REG 1 | NACK | STOP |
|-------|----------------------|--------------|-----|----------------------------|-----|-------|----------------------|--------------|-----|-----------------|-----|-----------------|------|------|
| | 110000[ADDR2][ADDR1] | 0 | — | 0x00 | — | | 110000[ADDR2][ADDR1] | 1 | — | D7–D0 | — | D7–D0 | — | |

Figure 3. Example: Read data from registers 0 and 1.

Multiband Digital Television Tuner

Control Register Description

The MAX3544 includes 18 programmable registers, two status registers (read only), one register for ROM readback (read only), and one for Maxim use only. The programmable registers configure the VCO settings, PLL settings, detector and AGC settings, state control, bias adjustments, individual block shutdown, and the tracking filter frequency. These programmable registers are also readable. The read-only registers include two status registers and a ROM table data register.

Typical bit settings are provided only for user convenience and are not guaranteed at power-up. All registers must be written no earlier than 100 μ s after power-up or recovery from a brownout event (i.e., when V_{CC} drops below 1V) to initialize the registers. Then follow up by rewriting the registers needed for channel/frequency programming (i.e., registers R00–R04). The typical values listed in Table 3 configure the MAX3544 for DVB-T reception with 16MHz crystal, 8MHz channel BW, 36.15MHz IF center frequency, differential LC bandpass filter, and 666MHz RF center frequency.

Table 3. Register Configuration

| REG ADDR | REG NAME | REGISTER FUNCTION | TYPICAL SETTING | BIT LOCATION | | | | | | | |
|----------|----------|--------------------------|-----------------|--------------|-----------|------------|------------|-----------|-------------|------------|--------|
| | | | | MSB | 7 | 6 | 5 | 4 | 3 | 2 | 1 |
| 0x00 | R00 | VCO | 4C | VCO[1:0] | | VSUB[3:0] | | | VDIV[1:0] | | |
| 0x01 | R01 | NDIV INT | 2B | NINT[7:0] | | | | | | | |
| 0x02 | R02 | NDIV FRAC2 | 8E | CPS | CP | RDIV[1:0] | | F[19:16] | | | |
| 0x03 | R03 | NDIV FRAC1 | 26 | F[15:8] | | | | | | | |
| 0x04 | R04 | NDIV FRAC0 (VAS Trigger) | 66 | F[7:0] | | | | | | | |
| 0x05 | R05 | MODE CTRL | D8 | LNA2G | RFIN | RFLPF | CHBW | TFB[1:0] | | IFSEL[1:0] | |
| 0x06 | R06 | TFS | 30 | TFS[7:0] | | | | | | | |
| 0x07 | R07 | TFP | 12 | — | — | TFP[5:0] | | | | | |
| 0x08 | R08 | SHUTDOWN | 00 | STBY | SDRF | SDMIX | SDIF | SDIFVG | SDPD | SDSYN | SDVCO |
| 0x09 | R09 | REF CONFIG | 0A | — | — | — | CPLIN[1:0] | | ALC[1:0] | | XODIV |
| 0x0A | R0A | VAS CONFIG | 17 | LFDIV[1:0] | | VASS | VAS | ADL | ADE | LTC[1:0] | |
| 0x0B | R0B | PWRDET CFG1 | 43 | DWPD | WPDA[2:0] | | | DNPD | NPDA[2:0] | | |
| 0x0C | R0C | PWRDET CFG2 | 01 | — | — | — | — | — | PULLUP | RFIFD[1:0] | |
| 0x0D | R0D | FILT CF ADJ | ROM | — | — | CFSET[5:0] | | | | | |
| 0x0E | R0E | ROM ADDR | 00 | — | — | — | — | ROMA[3:0] | | | |
| 0x0F | R0F | IRHR | ROM | IRHR[7:0] | | | | | | | |
| 0x10 | R10 | ROM READBACK | RO | ROMR[7:0] | | | | | | | |
| 0x11 | R11 | VAS STATUS | RO | VVCO[1:0] | | | VVSB[3:0] | | | VASA | VASE |
| 0x12 | R12 | GEN STATUS | RO | — | — | VCP | TRIM | POR | VCOADC[2:0] | | |
| 0x13 | R13 | BIAS ADJ | 56 | — | MIXGM | LNA2B[1:0] | | MIXB[1:0] | | FILTB | IFVGAB |
| 0x14 | R14 | TEST1 | 40 | RESERVED | | | | | | | |
| 0x15 | R15 | ROM WRITE DATA | 00 | ROMW[7:0] | | | | | | | |

Note: Registers should be written in the order of ascending addresses. When changing frequency, write R00 to R07 in order of ascending addresses to ensure proper VCO setup.

Multiband Digital Television Tuner

Register and Bit Descriptions

MAX3544

Table 4. R00: VCO Register—VCO and LO Divider Control (Address: 00h)

| BIT NAME | BIT LOCATION (0 = LSB) | TYPICAL SETTING | FUNCTION |
|-----------|---------------------------|--------------------|---|
| VCO[1:0] | 7:6 | 01 | VCO select. Selects one of three VCOs when VAS = 0, or selects the VCO starting band when VASS = 0. 00 = Selects VCO1 (approximately 2200MHz to 2800MHz) 01 = Selects VCO2 (approximately 2800MHz to 3500MHz) 10 = Selects VCO3 (approximately 3500MHz to 4400MHz) 11 = VCO shutdown |
| VSUB[3:0] | 5:2 | 0011 | VCO sub-band select. Selects one of 16 possible VCO sub-bands when VAS = 0, or selects the VCO starting sub-band when VASS = 0. 0000 = Selects SB0 ... 1111 = Selects SB15 |
| VDIV[1:0] | 1:0 | 00 | VCO divider ratio select. 00 = Sets VCO divider to 4 (use when $f_{LO} > 550\text{MHz}$) 01 = Sets VCO divider to 8 (use when $275\text{MHz} < f_{LO} < 550\text{MHz}$) 10 = Sets VCO divider to 16 (use when $137.5\text{MHz} < f_{LO} < 275\text{MHz}$) 11 = Sets VCO divider to 32 (use when $f_{LO} < 137.5\text{MHz}$) |

Table 5. R01: NDIV INT Register—Integer Part of N-Divider (Address: 01h)

| BIT NAME | BIT LOCATION (0 = LSB) | TYPICAL SETTING | FUNCTION |
|-----------|---------------------------|--------------------|--|
| NINT[7:0] | 7:0 | 0010 1011 | Sets the PLL integer divide number (N) |

Table 6. R02: NDIV FRAC2 Register—N-Divider Fractional Part [19:16] and R-Divider (Address: 02h)

| BIT NAME | BIT LOCATION (0 = LSB) | TYPICAL SETTING | FUNCTION |
|-----------|---------------------------|--------------------|---|
| CPS | 7 | 1 | Sets the charge-pump current-selection mode between automatic and manual. Must set to 1 for proper operation. |
| CP | 6 | 0 | For Maxim use only |
| RDIV[1:0] | 5:4 | 00 | Reference divider. 00 = /1 01 = /2 1X = Maxim use only |
| F[19:16] | 3:0 | 1110 | N-divider fractional part bits 19:16 (out of 19:0) |

Multiband Digital Television Tuner

Table 7. R03: NDIV FRAC1 Register—N-Divider Fractional Part [15:8] (Address: 03h)

| BIT NAME | BIT LOCATION (0 = LSB) | TYPICAL SETTING | FUNCTION |
|----------|---------------------------|--------------------|---|
| F[15:8] | 7:0 | 0010 0110 | N-divider fractional part bits 15:8 (out of 19:0) |

Table 8. R04: NDIV FRAC0 Register—N-Divider Fractional Part [7:0] (Address: 04h)

| BIT NAME | BIT LOCATION (0 = LSB) | TYPICAL SETTING | FUNCTION |
|----------|---------------------------|--------------------|---|
| F[7:0] | 7:0 | 0110 0110 | N-divider fractional part bits 7:0 (out of 19:0). Writing this register also triggers VCO autoselect (VAS). |

Table 9. R05: MODE CTRL Register—Mode Control (Address: 05h)

| BIT NAME | BIT LOCATION (0 = LSB) | TYPICAL SETTING | FUNCTION |
|------------|---------------------------|--------------------|---|
| LNA2G | 7 | 1 | Premixer gain configuration. Set to 1 for nominal gain. Set to 0 for approximately 2.5dB reduced gain. |
| RFIN | 6 | 1 | 0 = Selects RFINL input (for $f_{RF} < 345\text{MHz}$) 1 = Selects RFINH input (for $f_{RF} > 345\text{MHz}$) |
| RFLPF | 5 | 0 | 0 = Disables RF LPF (for $f_{RF} > 110\text{MHz}$) 1 = Enables RF LPF (for $f_{RF} < 110\text{MHz}$) |
| CHBW | 4 | 1 | 0 = Sets IF BW to 7MHz mode 1 = Sets IF BW to 8MHz mode |
| TFB[1:0] | 3:2 | 10 | Selects the tracking filter band of operation. 00 = VHFL (for $f_{RF} < 196\text{MHz}$) 01 = VHFH (for $196\text{MHz} < f_{RF} < 440\text{MHz}$) 10 = UHF (for $f_{RF} > 440\text{MHz}$) 11 = Unused |
| IFSEL[1:0] | 1:0 | 00 | IF output selection. 00 = IFOUT1 differential mode (for driving a differential bandpass filter) 01 = IFOUT1 single-ended (for driving a switched BW single-ended SAW filter) 10 = Unused 11 = Unused |

Table 10. R06: TFS Register—Tracking Filter Series Capacitor (Address: 06h)

| BIT NAME | BIT LOCATION (0 = LSB) | TYPICAL SETTING | FUNCTION |
|----------|---------------------------|--------------------|---|
| TFS[7:0] | 7:0 | N/A | Programs series capacitor values in the tracking filter. The value is determined from the values in the ROM table applied to an equation executed in the Maxim-provided device driver code. |

Multiband Digital Television Tuner

Table 11. R07: TFP Register—Tracking Filter Parallel Capacitor (Address: 07h)

| BIT NAME | BIT LOCATION (0 = LSB) | TYPICAL SETTING | FUNCTION |
|----------|---------------------------|--------------------|---|
| EMPTY | 7:6 | 00 | Empty |
| TFP[5:0] | 5:0 | N/A | Programs parallel capacitor values in the tracking filter. The value is determined from the values in the ROM table applied to an equation executed in the Maxim-provided device driver code. |

Table 12. R08: SHUTDOWN Register—Shutdown Control (Address: 08h)

| BIT NAME | BIT LOCATION (0 = LSB) | TYPICAL SETTING | FUNCTION |
|----------|---------------------------|--------------------|---|
| STBY | 7 | 0 | Standby. 1 = All circuits shut down except crystal oscillator and REFOUT |
| SDRF | 6 | 0 | RF shutdown. Must set to 0 for proper operation. |
| SDMIX | 5 | 0 | Mixer shutdown. Must set to 0 for proper operation. |
| SDIF | 4 | 0 | IF shutdown. Must set to 0 for proper operation. |
| SDIFVG | 3 | 0 | IF VGA shutdown. 0 = IF VGA enabled 1 = IF VGA disabled |
| SDPD | 2 | 0 | Power-detector shutdown. Must set to 0 for proper operation. |
| SDSYN | 1 | 0 | Frequency synthesizer shutdown. Must set to 0 for proper operation. |
| SDVCO | 0 | 0 | VCO shutdown. Must set to 0 for proper operation. |

Table 13. R09: REF CONFIG Register—Reference Oscillator Configuration (Address: 09h)

| BIT NAME | BIT LOCATION (0 = LSB) | TYPICAL SETTING | FUNCTION |
|------------|---------------------------|--------------------|---|
| EMPTY | 7:5 | 000 | Empty |
| CPLIN[1:0] | 4:3 | 01 | Must set to 01 for proper operation |
| ALC[1:0] | 2:1 | 01 | Must set to 01 for proper operation |
| XODIV | 0 | 0 | Sets crystal oscillator divider for REFOUT signal when REFDIV pin is unconnected. 0: $f_{REFOUT} = f_{XTAL}/4$ 1: $f_{REFOUT} = f_{XTAL}$ |

Multiband Digital Television Tuner

Table 14. R0A: VAS CONFIG Register—VCO Autoselect Configuration (Address: 0Ah)

| BIT NAME | BIT LOCATION (0 = LSB) | TYPICAL SETTING | FUNCTION |
|------------|---------------------------|--------------------|---|
| LFDIV[1:0] | 7:6 | 00 | Sets the low-frequency clock-divider. 00 = Use for $16\text{MHz} \leq f_{\text{REF}} < 20\text{MHz}$ 01 = Use for $20\text{MHz} \leq f_{\text{REF}} < 28\text{MHz}$ 10 = Use for $28\text{MHz} \leq f_{\text{REF}} \leq 32\text{MHz}$ 11 = Unused |
| VASS | 5 | 0 | Controls the VCO autoselect (VAS) start conditions function. 0 = VAS starts from the current VCO/VCOSB loaded in the VCO[1:0] and VSUB[3:0] bits (in R00) 1 = VAS starts from the currently used VCO and VCOSB |
| VAS | 4 | 1 | Controls the VCO autoselect (VAS) function. Must set to 1 for proper operation. |
| ADL | 3 | 0 | Enables or disables the VCO tuning voltage ADC latch when the VCO autoselect (VAS) mode is disabled. 0 = Disables the ADC latch 1 = Latches the ADC value |
| ADE | 2 | 0 | Enables or disables VCO tuning voltage ADC read when the VCO autoselect (VAS) mode is disabled. 0 = Disables ADC read 1 = Enables ADC read |
| LTC[1:0] | 1:0 | 10 | Sets the VCO autoselect wait time. Must set to 10 for proper operation. |

Note: Only production tested and guaranteed functional in states 0001 0010, 0101 0010, and 1001 0010. All other states are untested and may not function correctly. Contact Maxim if untested settings will be used in production.

Table 15. R0B: PWRDET CFG1 Register—Power-Detector Configuration 1 of 2 (Address: 0Bh)

| BIT NAME | BIT LOCATION (0 = LSB) | TYPICAL SETTING | FUNCTION |
|-----------|---------------------------|--------------------|--|
| DWPD | 7 | 0 | Enables or disables wideband power detector. Use this state for autonomous RFAGC. 0 = Enables wideband power detector 1 = Disables wideband power detector |
| WPDA[2:0] | 6:4 | 100 | Sets the wideband power-detector attack point (takeover point). 000 = Min 100 = Nom (see the <i>Typical Operating Characteristics</i>) 111 = Max |
| DNPD | 3 | 0 | Enables or disables narrowband power detector. Use this state for autonomous RFAGC. 0 = Enables narrowband detector 1 = Disables narrowband detector |
| NPDA[2:0] | 2:0 | 011 | Sets the narrowband power-detector attack point (takeover point). 000 = Min 011 = Nom (see the <i>Typical Operating Characteristics</i>) 111 = Max |

Note: Only production tested and guaranteed functional in state X100 X011, where X can be either 0 or 1. All other states are untested and may not function correctly. Contact Maxim if untested settings will be used in production.

Multiband Digital Television Tuner

Table 16. R0C: PWRDET CFG2 Register—Power-Detector Configuration 2 of 2 (Address: 0Ch)

| BIT NAME | BIT LOCATION (0 = LSB) | TYPICAL SETTING | FUNCTION |
|------------|---------------------------|--------------------|--|
| EMPTY | 7:3 | 0000 0 | Empty |
| PULLUP | 2 | 0 | Must set to 0 for proper operation |
| RFIFD[1:0] | 1:0 | 01 | RF IF AGC diode voltage. 00 = Approximately 0.6V 01 = Approximately 0.95V 10 = Approximately 1.3V 11 = Off |

Table 17. R0D: FILT CF ADJ Register—IF Filter Center Frequency and BW Adjustment (Address: 0Dh)

| BIT NAME | BIT LOCATION (0 = LSB) | TYPICAL SETTING | FUNCTION |
|------------|---------------------------|--------------------|---|
| EMPTY | 7:6 | 00 | Empty |
| CFSET[5:0] | 5:0 | ROM | Sets the IF filter center frequency and bandwidth. For proper operation, must read value from ROM address A[5:0] and write that value to this register. |

Note: Only production tested and guaranteed functional in factory-trimmed state from ROM table. All other states are untested and may not function correctly. Contact Maxim if untested settings will be used in production.

Table 18. R0E: ROM ADDR Register—ROM Address (Address: 0Eh)

| BIT NAME | BIT LOCATION (0 = LSB) | TYPICAL SETTING | FUNCTION |
|-----------|---------------------------|--------------------|--|
| EMPTY | 7:4 | 00 | Empty |
| ROMA[3:0] | 3:0 | 0000 | Address bits of the ROM register to be read or written. Must set to 0000 when not reading the ROM table. |

Table 19. R0F: IRHR Register (Address: 0Fh)

| BIT NAME | BIT LOCATION (0 = LSB) | TYPICAL SETTING | FUNCTION |
|-----------|---------------------------|--------------------|--|
| IRHR[7:0] | 7:0 | ROM | For proper operation, must read value from ROM address B[7:0] and write that value to this register. |

Note: Only production tested and guaranteed functional in factory-trimmed state from ROM table. All other states are untested and may not function correctly.

Table 20. R10: ROM READBACK Register—ROM Readback (Address: 10h)

| BIT NAME | BIT LOCATION (0 = LSB) | TYPICAL SETTING | FUNCTION |
|-----------|---------------------------|--------------------|--|
| ROMR[7:0] | 7:0 | N/A | Data bits read from the ROM table address as specified by R0E[3:0] |

Multiband Digital Television Tuner

Table 21. R11: VAS STATUS Register—VCO Autoselect Status (Address: 11h)

| BIT NAME | BIT LOCATION (0 = LSB) | TYPICAL SETTING | FUNCTION |
|-----------|---------------------------|--------------------|--|
| VVCO[1:0] | 7:6 | N/A | Indicates which VCO has been selected by either the autoselect state machine or by manual selection when the VSA state machine is disabled. See the R00 description for the VCO[1:0] definition. |
| VVSB[3:0] | 5:2 | N/A | Indicates which sub-band of a particular VCO has been selected by either the autoselect state machine or by manual selection when the VSA state machine is disabled. See the R00 description for the VSUB[3:0] definition. |
| VASA | 1 | N/A | Indicates whether VCO autoselection was successful. 0 = Indicates the autoselect function is disabled or unsuccessful VCO selection 1 = Indicates successful VCO autoselection |
| VASE | 0 | N/A | Status indicator for the autoselect function. 0 = Indicates the autoselect function is active 1 = Indicates the autoselect process is inactive |

Note: Not production tested or guaranteed functional.

Table 22. R12: GEN STATUS Register—General Status (Address: 12h)

| BIT NAME | BIT LOCATION (0 = LSB) | TYPICAL SETTING | FUNCTION |
|-----------------|---------------------------|--------------------|--|
| EMPTY | 7:6 | N/A | Empty |
| VCP | 5 | N/A | Maxim use only |
| TRIM | 4 | N/A | Maxim use only |
| POR | 3 | N/A | Maxim use only |
| VCOADC [2:0] | 2:0 | N/A | VCO tuning voltage indicators. 000 = PLL not in lock, tune to the next lowest sub-band 001 to 110 = PLL in lock 111 = PLL not in lock, tune to the next higher sub-band |

Note: Not production tested or guaranteed functional.

Table 23. R13: BIAS ADJ Register—Bias Adjustments (Address: 13h)

| BIT NAME | BIT LOCATION (0 = LSB) | TYPICAL SETTING | FUNCTION |
|------------|---------------------------|--------------------|---|
| EMPTY | 7 | 0 | Empty |
| MIXGM | 6 | 1 | Mixer gain setting. Set to 1 for nominal gain. Set to 0 for approximately 2dB reduced gain. |
| LNA2B[1:0] | 5:4 | 01 | LNA bias. 00 = Unused 01 = Nominal setting 10 = Unused 11 = Highest linearity setting |

Multiband Digital Television Tuner

MAX3544

Table 23. R13: BIAS ADJ Register—Bias Adjustments (Address: 13h) (continued)

| BIT NAME | BIT LOCATION (0 = LSB) | TYPICAL SETTING | FUNCTION |
|-----------|---------------------------|--------------------|---|
| MIXB[1:0] | 3:2 | 01 | Mixer bias. 00 = Unused 01 = Nominal setting 10 = Unused 11 = Highest linearity setting |
| FILTB | 1 | 1 | Must set to 1 for proper operation |
| IFVGAB | 0 | 0 | IF VGA bias. 0 = Default 1 = Highest current (approximately nominal + 6mA) |

Note: Only production tested and guaranteed functional in state 0XX1 X11X, where X can be either 1 or 0. All other states are untested and may not function correctly. Contact Maxim if untested settings will be used in production.

Table 24. R14: TEST1 Register (Address: 14h)

| BIT NAME | BIT LOCATION (0 = LSB) | TYPICAL SETTING | FUNCTION |
|----------|---------------------------|--------------------|--|
| RESERVED | 7:0 | 0100 0000 | Must set to 0100 0000 for proper operation |

Note: This register is not available to the end user.

Table 25. R15: ROM WRITE DATA Register (Address: 15h)

| BIT NAME | BIT LOCATION (0 = LSB) | TYPICAL SETTING | FUNCTION |
|-----------|---------------------------|--------------------|----------------|
| ROMW[7:0] | 7:0 | N/A | Maxim use only |

Note: This register is not available to the end user.

Applications Information

RF Inputs and Filters

The MAX3544 features separate low- and high-frequency inputs. These two inputs are combined to a single input by an off-chip diplexer circuit as shown in the *Typical Application Circuit*. When the desired channel is less than 345MHz, use RFINL. When the desired input is greater than 345MHz, use RFINH. Further, when the desired input is less than 110MHz, an internal lowpass filter should be enabled to limit high-frequency interference incident at the mixer input. The lowpass filter is enabled by the RFLPF bit in R05[5].

Besides selecting the appropriate input port and setting

RFLPF appropriately, one of three tracking filters must be chosen based on the desired frequency. Set TFB (R05[3:2]) to select VHFL, VHFH, or UHF tracking filter bands. Use VHFL when the desired frequency is less than 196MHz, use VHFH when the desired frequency is between 196MHz and 440MHz, or use UHF when the desired frequency is greater than 440MHz.

RF Gain Control

The MAX3544 is designed to control its own RF gain based on internally measured signal and blocker levels. The user can adjust the AGC attack points (takeover points) by setting WDPA and NDPA in register ROB. Alternatively, the user can control the RF gain by driving the RFVGC input pin.

Multiband Digital Television Tuner

Table 26. ROM Table

| DESCRIPTION | ADDR | MSB | | | DATA BYTE | | | | LSB |
|---|------|----------|----------|----------|-----------|----------|----------|----------|----------|
| BIAS | 0x0 | Unused | | | BIAS[3:0] | | | | |
| VHF-Low Tracking Filter. VLS0, VLS1, VLP0, VLP1 | 0x1 | VLS0[5] | VLS0[4] | VLS0[3] | VLS0[2] | VLS0[1] | VLS0[0] | VLS1[5] | VLS1[4] |
| | 0x2 | VLS1[3] | VLS1[2] | VLS1[1] | VLS1[0] | VLP0[5] | VLP0[4] | VLP0[3] | VLP0[2] |
| | 0x3 | VLP0[1] | VLP0[0] | VLP1[5] | VLP1[4] | VLP1[3] | VLP1[2] | VLP1[1] | VLP1[0] |
| VHF-High Tracking Filter. VHS0, VHS1, VHP0, VHP1 | 0x4 | VHS0[5] | VHS0[4] | VHS0[3] | VHS0[2] | VHS0[1] | VHS0[0] | VHS1[5] | VHS1[4] |
| | 0x5 | VHS1[3] | VHS1[2] | VHS1[1] | VHS1[0] | VHP0[5] | VHP0[4] | VHP0[3] | VHP0[2] |
| | 0x6 | VHP0[1] | VHP0[0] | VHP1[5] | VHP1[4] | VHP1[3] | VHP1[2] | VHP1[1] | VHP1[0] |
| UHF Tracking Filter. US0, US1, UP0, UP1 | 0x7 | US0[5] | US0[4] | US0[3] | US0[2] | US0[1] | US0[0] | US1[5] | US1[4] |
| | 0x8 | US1[3] | US1[2] | US1[1] | US1[0] | UP0[5] | UP0[4] | UP0[3] | UP0[2] |
| | 0x9 | UP0[1] | UP0[0] | UP1[5] | UP1[4] | UP1[3] | UP1[2] | UP1[1] | UP1[0] |
| IF Filter | 0xA | Unused | Unused | C[5] | C[4] | C[3] | C[2] | C[1] | C[0] |
| IRHR | 0xB | IRHR[7] | IRHR[6] | IRHR[5] | IRHR[4] | IRHR[3] | IRHR[2] | IRHR[1] | IRHR[0] |
| Reserved | 0xC | Reserved | Reserved | Reserved | Reserved | Reserved | Reserved | Reserved | Reserved |

VCO and VCO Divider Selection

The MAX3544 frequency synthesizer includes three VCOs with 16 sub-bands for each VCO. These VCOs and sub-bands are selected to best center the VCO near the operating frequency. This selection process is performed automatically by the VAS circuitry. The Maxim driver software seeds the VCO starting band for fastest selection time.

In addition to VCO selection, a VCO divider value of 32, 16, 8, or 4 must be selected to provide the desired mixer LO drive frequency. The divider is selected by VDIV in register R00[1:0].

Reading the ROM Table

The MAX3544 includes 13 ROM registers to store factory calibration data (see Table 26). Each ROM table entry must be read using a two-step process. First, the address of the ROM bits to be read must be programmed into the ROM ADDR register (R0E[3:0]).

Once the address has been programmed, the data stored in that address is automatically transferred to the ROM READBACK register (R10[7:0]). The ROM data at the specified address can then be read from the ROM READBACK register and stored in the microprocessor's

local memory. After all ROM registers have been read and stored in the microprocessor's local memory, ROM ADDR must be programmed to 00 for proper operation.

Setting RF Tracking Filter Codes

The MAX3544 includes a programmable tracking filter for each band of operation to optimize rejection of out-of-band interference while minimizing insertion loss for the desired received signal. The center frequency of each tracking filter is selected by a switched-capacitor array that is programmed by the TFS[7:0] bits in the R06 register and the TFP[5:0] bits in the R07 register.

Optimal tracking filter settings for each channel vary from part to part due to process variations. To accommodate part-to-part variations, each part is factory calibrated by Maxim. During calibration the correction factors for the series and parallel tracking capacitor arrays are calculated and written into an internal ROM table. The user must read the ROM table upon power-up and store the data in local memory (8 bytes total) to calculate the optimal TFS and TFP settings for each channel. The equation for setting TFS and TFP at each channel is available in the device driver code provided by Maxim. Table 26 shows the address and bits for each ROM table entry.

Multiband Digital Television Tuner

MAX3544

Layout Recommendations

IMPORTANT: The MAX3544 includes on-chip tracking filters that utilize external inductors placed on the PCB at pins 30 through 37. Because the tracking filters operate at frequencies up to 862MHz, they are sensitive to the inductor and PCB trace parasitics. To achieve the optimal RF performance (gain, noise figure, and image rejection), the MAX3544 is production tested and trimmed with the exact inductors, their relative location and orientation, and the trace parasitics present on the MAX3544 Reference Design. To avoid performance degradation, PCB designs should exactly copy the RF section of the Reference Design layout and use the inductors specified in the Reference Design bill of materials. Contact Maxim to obtain the Reference Design layout to use as a starting point for PCB designs.

In addition to the aforementioned requirements, follow general good RF layout practices. Keep RF signal lines

as short as possible to minimize losses and radiation. Use controlled impedance on all high-frequency traces. The exposed paddle must be soldered evenly to the board's ground plane for proper operation. Use abundant vias beneath the exposed paddle and maximize the area of continuous ground plane around the paddle on the bottom layer for maximum heat dissipation. Use abundant ground vias between RF traces to minimize undesired coupling.

To minimize coupling between different sections of the IC, the ideal power-supply layout is a star configuration, which has a large decoupling capacitor at the central VCC node. The VCC traces branch out from this node, with each trace going to separate VCC pins of the MAX3544. Each VCC pin must have a bypass capacitor with a low impedance to ground at the frequency of interest. Do not share ground vias among multiple connections to the PCB ground plane.

Package Information

For the latest package outline information and land patterns, go to www.maxim-ic.com/packages. Note that a "+", "#", or "-" in the package code indicates RoHS status only. Package drawings may show a different suffix character, but the drawing pertains to the package regardless of RoHS status.

| PACKAGE TYPE | PACKAGE CODE | OUTLINE NO. | LAND PATTERN NO. |
|--------------|--------------|-------------------------|-------------------------|
| 40 TQFN-EP | T4066+2 | 21-0141 | 90-0053 |

Multiband Digital Television Tuner

Revision History

| REVISION NUMBER | REVISION DATE | DESCRIPTION | PAGES CHANGED |
|-----------------|---------------|-----------------|---------------|
| 0 | 7/10 | Initial release | — |

Maxim cannot assume responsibility for use of any circuitry other than circuitry entirely embodied in a Maxim product. No circuit patent licenses are implied. Maxim reserves the right to change the circuitry and specifications without notice at any time.

20 _____ **Maxim Integrated Products, 120 San Gabriel Drive, Sunnyvale, CA 94086 408-737-7600**