



Chipsmall Limited consists of a professional team with an average of over 10 year of expertise in the distribution of electronic components. Based in Hongkong, we have already established firm and mutual-benefit business relationships with customers from,Europe,America and south Asia,supplying obsolete and hard-to-find components to meet their specific needs.

With the principle of “Quality Parts,Customers Priority,Honest Operation,and Considerate Service”,our business mainly focus on the distribution of electronic components. Line cards we deal with include Microchip,ALPS,ROHM,Xilinx,Pulse,ON,Everlight and Freescale. Main products comprise IC,Modules,Potentiometer,IC Socket,Relay,Connector.Our parts cover such applications as commercial,industrial, and automotives areas.

We are looking forward to setting up business relationship with you and hope to provide you with the best service and solution. Let us make a better world for our industry!



Contact us

Tel: +86-755-8981 8866 Fax: +86-755-8427 6832

Email & Skype: info@chipsmall.com Web: www.chipsmall.com

Address: A1208, Overseas Decoration Building, #122 Zhenhua RD., Futian, Shenzhen, China



622Mbps/1244Mbps Burst-Mode Clock Phase Aligner for GPON OLT Applications

General Description

The MAX3634 burst-mode clock phase aligner (CPA) is designed specifically for 622Mbps or 1244Mbps GPON (ITU G.984) optical line terminal (OLT) receiver applications. The MAX3634 provides clock and clock-aligned resynchronized upstream data through differential LVPECL outputs. Using the OLT system clock as a reference, the MAX3634 aligns to the input data and acquires within the first 13 bits of the burst. The CPA operates with received data that is frequency locked to the OLT reference. The acquisition time, bit-error ratio, and jitter tolerance all support GPON PMD specifications. LVPECL high-speed clock and data outputs provide compatibility with FPGAs at 622Mbps and with the MAX3885 deserializer at 1244Mbps.

The MAX3634 is available in a low-profile, 7mm x 7mm, 48-lead TQFN package. The MAX3634 operates from a single +3.3V supply, over the -40°C to +85°C temperature range.

Applications

622Mbps GPON OLT Receivers
1244Mbps GPON OLT Receivers

Features

- ◆ DC-Coupled Clock Phase Aligner for Burst-Mode GPON Applications
- ◆ 13-Bit Burst Acquisition Time
- ◆ 0.85UI High-Frequency Jitter Tolerance
- ◆ Continuous Clock Output
- ◆ Byte Rate (1/8th Data Rate) Reference Clock Input
- ◆ Lock Detect Output
- ◆ LVPECL Serial Data Input and Output
- ◆ LVPECL Reset Input

Ordering Information

PART	TEMP RANGE	PIN-PACKAGE	PKG CODE
MAX3634ETM	-40°C to +85°C	48 TQFN (7mm x 7mm)	T4877-6

Pin Configuration appears at end of data sheet.

Typical Application Circuit

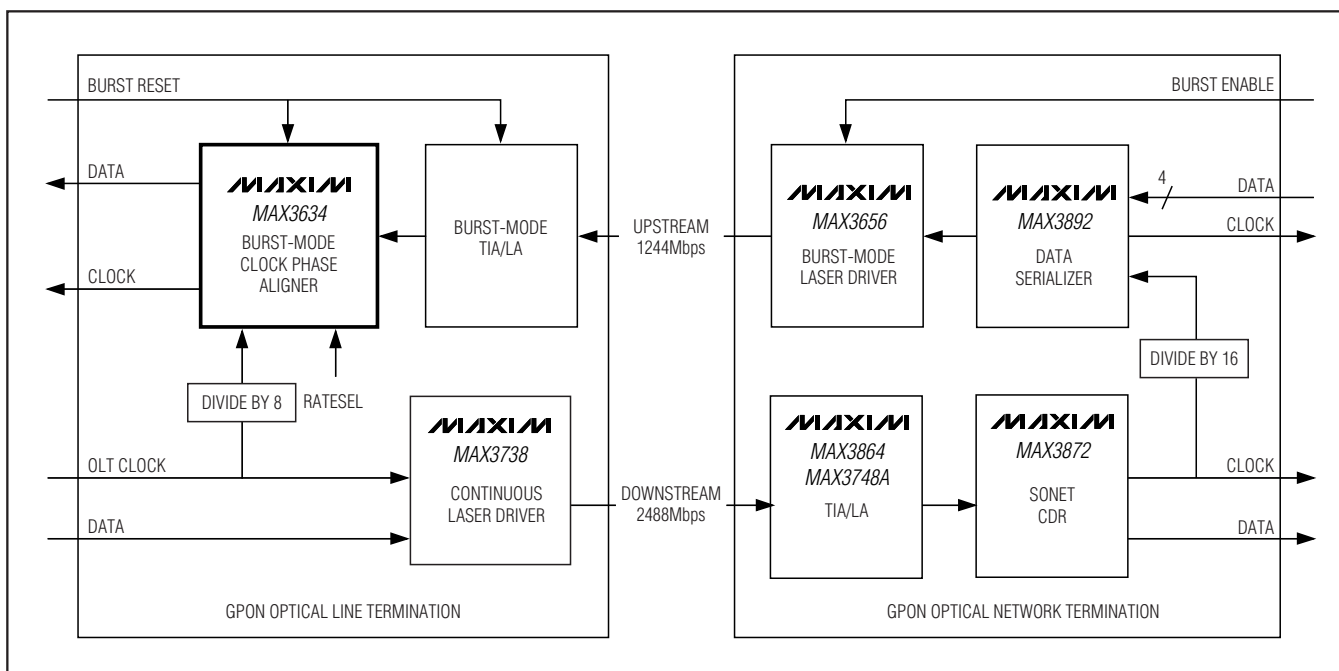

622Mbps/1244Mbps Burst-Mode Clock Phase Aligner for GPON OLT Applications

ABSOLUTE MAXIMUM RATINGS

V_{CC} , V_{CC1} , V_{CC0} , V_{CCV}	-0.5V to +4.0V	Continuous Power Dissipation ($T_A = +85^\circ\text{C}$) 48-Lead TQFN package
SDI_{\pm} , RST_{\pm} , $REFCLK_{\pm}$, RATESEL, FILT, TEST	-0.5V to ($V_{CC} + 0.5\text{V}$)	(derate 27.8mW/ $^\circ\text{C}$ above $+85^\circ\text{C}$).....
LVPECL Output Current (SDO_{\pm} , $SCLK_{\pm}$, $LOCK_{\pm}$)	50mA	1800mW
		Storage Temperature Range
		-55 $^\circ\text{C}$ to +150 $^\circ\text{C}$
		Operating Ambient Temperature Range
		-40 $^\circ\text{C}$ to +85 $^\circ\text{C}$
		Lead Temperature (soldering, 10s)
		+400 $^\circ\text{C}$

Stresses beyond those listed under "Absolute Maximum Ratings" may cause permanent damage to the device. These are stress ratings only, and functional operation of the device at these or any other conditions beyond those indicated in the operational sections of the specifications is not implied. Exposure to absolute maximum rating conditions for extended periods may affect device reliability.

ELECTRICAL CHARACTERISTICS

($V_{CC} = +3.0\text{V}$ to $+3.6\text{V}$, $T_A = -40^\circ\text{C}$ to $+85^\circ\text{C}$. Typical values are at $V_{CC} = +3.3\text{V}$, $T_A = +25^\circ\text{C}$, unless otherwise noted.)

PARAMETER	SYMBOL	CONDITIONS	MIN	TYP	MAX	UNITS
Supply Current	I_{CC}	Not including LVPECL output current		315	390	mA
Data Rate		RATESEL = low		1244.16		Mbps
		RATESEL = high		622.08		
Reference Clock Input Frequency		RATESEL = low		155.52		MHz
		RATESEL = high		77.76		
SDI_{\pm} , RST_{\pm} , $REFCLK_{\pm}$ Differential Input	V_{IN}		200		1600	mV _{P-P}
SDI_{\pm} , RST_{\pm} , $REFCLK_{\pm}$ Input Current			-180		+180	μA
RST Input Rise/Fall Times	t_r , t_f	Rate = 1244Mbps			200	ps
		Rate = 622Mbps			200	
SDI_{\pm} , RST_{\pm} , $REFCLK_{\pm}$ Common-Mode Input			V_{CC} - 1.49		V_{CC} - $V_{IN}/4$	V
SDO_{\pm} , $SCLK_{\pm}$, $LOCK_{\pm}$ Output Voltage Low	V_{OL}	$T_A = 0^\circ\text{C}$ to $+85^\circ\text{C}$ (Note 1)	V_{CC} - 1.81		V_{CC} - 1.62	V
		$T_A = -40^\circ\text{C}$ to 0°C (Note 1)	V_{CC} - 1.83		V_{CC} - 1.555	
SDO_{\pm} , $SCLK_{\pm}$, $LOCK_{\pm}$ Output Voltage High	V_{OH}	$T_A = 0^\circ\text{C}$ to $+85^\circ\text{C}$ (Note 1)	V_{CC} - 1.025		V_{CC} - 0.88	V
		$T_A = -40^\circ\text{C}$ to 0°C (Note 1)	V_{CC} - 1.085		V_{CC} - 0.88	
Jitter Tolerance		622Mbps (Notes 2, 5, 6)	0.73	0.83		UI _{P-P}
		1244Mbps (Notes 2, 5, 6)	0.73	0.81		
Acquisition Time		(Notes 2, 3)			13	Bits
Bit-Error Ratio		After acquisition (Notes 2, 4)			10^{-10}	
SDO_{\pm} , $LOCK_{\pm}$ Transition Time	t_r , t_f	20% to 80% (Note 1)			265	ps
$SCLK_{\pm}$ Transition Time	t_r , t_f	20% to 80% (Note 1)			200	ps

622Mbps/1244Mbps Burst-Mode Clock Phase Aligner for GPON OLT Applications

ELECTRICAL CHARACTERISTICS (continued)

($V_{CC} = +3.0V$ to $+3.6V$, $T_A = -40^{\circ}C$ to $+85^{\circ}C$. Typical values are at $V_{CC} = +3.3V$, $T_A = +25^{\circ}C$, unless otherwise noted.)

PARAMETER	SYMBOL	CONDITIONS	MIN	TYP	MAX	UNITS
Serial Data Output Clock-to-Q Delay (Figure 1)	t_{CLK-Q}	622Mbps (Notes 1, 2)	500			ps
		1244Mbps (Notes 1, 2)	250			
Serial Data Output Q-to-Clock Delay (Figure 1)	t_{Q-CLK}	622Mbps (Notes 1, 2)	500			ps
		1244Mbps (Notes 1, 2)	250			
RATESEL Input High	V_{IH}		2			V
RATESEL Input Low	V_{IL}				0.8	V
RATESEL Input Current		$V_{IN} = 0V$ or V_{CC}	-100		+100	μA

Note 1: PECL output must have external termination of 50Ω to $V_{CC} - 2V$ (Thevenin equivalent).

Note 2: AC parameters are guaranteed by design and characterization.

Note 3: From start of PON burst, 101010101010 preamble sequence.

Note 4: BER, acquisition time requirements are met with 100mV_{P-P} sinusoidal noise on V_{CC} , $0 < f_{NOISE} \leq 10MHz$.

Note 5: Measured with 20ps_{RMS} input random jitter (1.244Mbps), 30ps_{RMS} (622Mbps)

Note 6: Jitter tolerance refers to the variation in phase between REFCLK and SDI after acquisition.

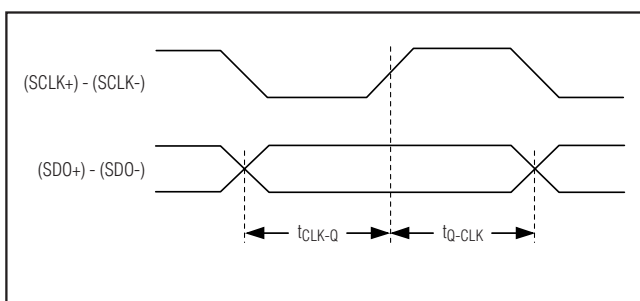
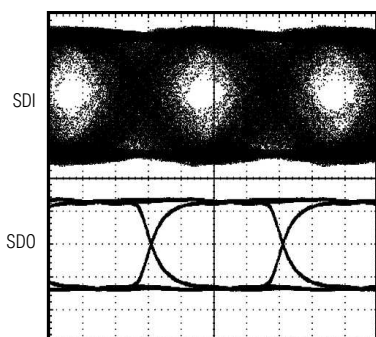

Figure 1. Definition of Clock-to-Q and Q-to-Clock Delay

Typical Operating Characteristics

($V_{CC} = +3.3V$ and $T_A = +25^{\circ}C$, unless otherwise noted)

**1.244Gbps
INPUT AND OUTPUT EYE DIAGRAMS**



200ps/div

**622Mbps
INPUT AND OUTPUT EYE DIAGRAMS**

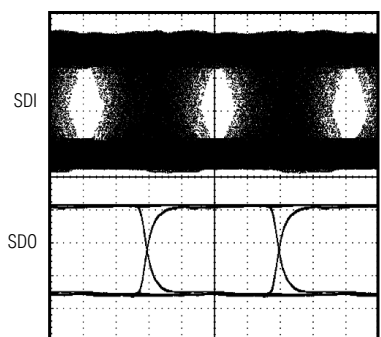

400ps/div

BURST CAPTURE AT 1.244Gbps

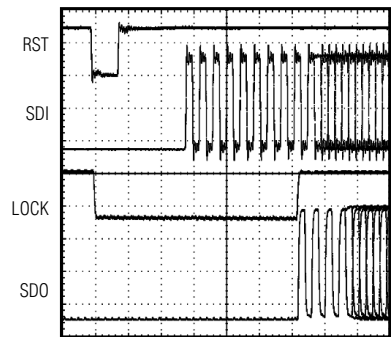

1ns/div

622Mbps/1244Mbps Burst-Mode Clock Phase Aligner for GPON OLT Applications

Typical Operating Characteristics (continued)

(V_{CC} = +3.3V and T_A = +25°C, unless otherwise noted)

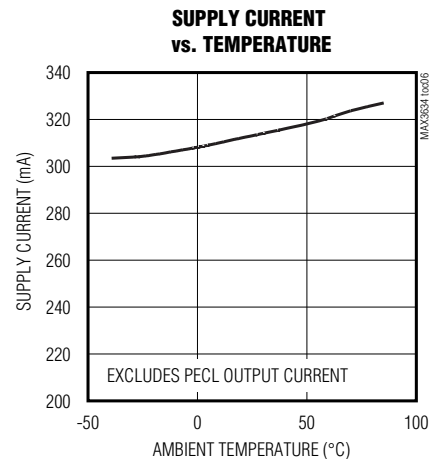
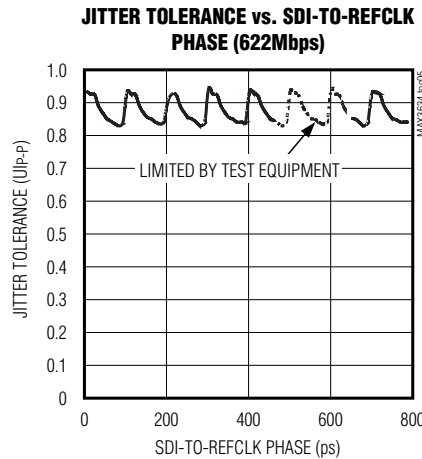
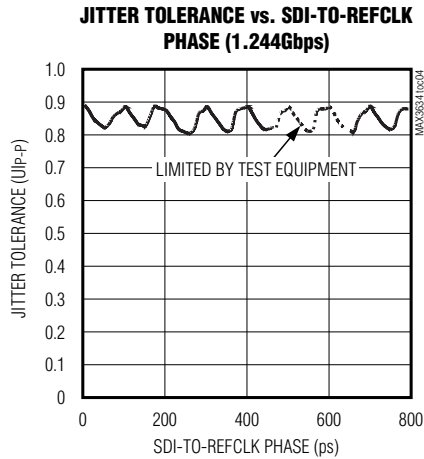

Pin Description

PIN	NAME	FUNCTION
1, 2, 12, 25, 36, 37, 48	GND	Supply Ground
3, 6, 7, 10	V _{CC1}	+3.3V Supply for Input Buffers
4	SDI+	Positive Serial Data Input, LVPECL
5	SDI-	Negative Serial Data Input, LVPECL
8	RST+	Positive Reset Input, LVPECL. Reset (= RST+ - RST-) is falling edge triggered.
9	RST-	Negative Reset Input, LVPECL
11, 38, 39, 44, 47	V _{CC}	+3.3V Supply for Digital Circuitry
13–20, 22, 23	TEST	Production Test Pins, Reserved. Leave open for normal operation.
21, 24, 26, 29, 32, 35	V _{CCO}	+3.3V Supply for Output Buffers
27	LOCK-	Negative Lock Status Output, LVPECL
28	LOCK+	Positive Lock Status Output, LVPECL. Lock (= (LOCK+) - (LOCK-)) high indicates that the MAX3634 has acquired the correct phase.
30	SDO-	Negative Serial Data Output, LVPECL
31	SDO+	Positive Serial Data Output, LVPECL
33	SCLK-	Negative Serial Clock Output, LVPECL
34	SCLK+	Positive Serial Clock Output, LVPECL
40	RATESEL	Rate Select Input, TTL. High selects 622.08Mbps operation.
41, 43	V _{CCV}	+3.3V Supply for VCO
42	FILT	PLL Filter Capacitor. Connect a 0.1µF X7R capacitor from pin 42 to V _{CCV} .
45	REFCLK-	Negative Reference Clock Input, LVPECL (1/8th data rate)
46	REFCLK+	Positive Reference Clock Input, LVPECL
EP	Exposed Pad	The exposed pad must be connected to the ground plane for proper thermal performance.

622Mbps/1244Mbps Burst-Mode Clock Phase Aligner for GPON OLT Applications

General Description

Theory of Operation

The MAX3634 CPA provides serial clock and data outputs for GPON upstream bursts.

The burst-mode CPA operates on the principle that the recovered clock from the ONT CDR is used at each ONT to clock upstream data bursts out of the ONT controller. The burst-mode CPA has logic that determines the correct phase relationship between the upstream data and the OLT reference clock at the beginning of each ONT's burst, and resamples the upstream data at each bit using that clock.

The burst-mode CPA contains a phase-locked loop (PLL) that synchronizes its oscillator to the reference clock input. This oscillator drives a phase splitter, which generates eight evenly spaced phases of the serial clock, which are used to sample the input data at 1/8th bit intervals in eight flip-flops. Combinatorial and sequential logic measures the preamble, and based on the phase of the preamble, determines which one of the eight clock phases is at the center of the input data bits. The data from the flip-flop associated with this phase is then steered through a multiplexer to the CPA output, which requires four or five additional clock periods until valid data is output. The CPA serial output

clock is continuous, without any phase jumps or discontinuities from burst to burst.

The burst-mode CPA requires a preamble sequence of 1010101010101 (13 bits) for correct phase alignment. Typically, output begins after the 12th bit, although for certain data/phase relationships, 13 bits are required. An LVPEACL-compatible lock status output is provided, which indicates when the correct phase has been acquired and valid serial output data is available. This output remains low until reset by the burst reset input (RST). The output data is disabled (held low) during the period between reset and lock.

Reference Clock Input

The MAX3634 includes a PLL, which multiplies the reference clock by eight for use in the retiming circuitry. For correct operation, the REFCLK input must be connected to the OLT byte-rate reference clock, which must be equal to 1/8th the serial data rate, and must have a 40% to 60% duty cycle. This must be the same clock source used to time the downstream data, and the upstream data must be frequency locked to this source.

The RATESEL input is used to configure 622Mbps or 1244Mbps operation; when RATESEL is high, the MAX3634 operates at 622Mbps.

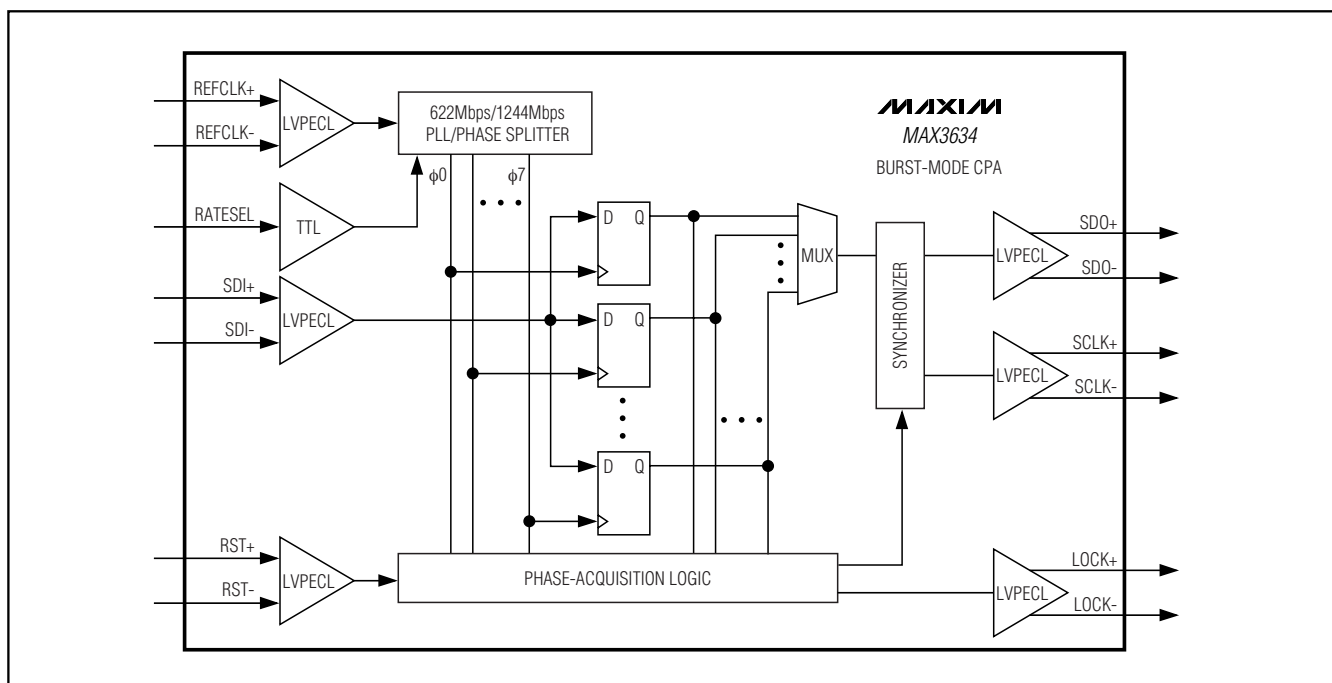

Figure 2. Functional Block Diagram

622Mbps/1244Mbps Burst-Mode Clock Phase Aligner for GPON OLT Applications

Input Stage

The LVPECL serial data input, SDI±, and burst-mode reset input, RST±, provide 200mV_{p-p} sensitivity. The RST± input rise and fall times (20% to 80%) must not exceed 200ps. LVPECL inputs must be DC-coupled with external termination for correct operation with burst data (see *Maxim Application Note HFAN 1.0* for termination configuration).

Lock Detect

After the first 12 or 13 bits of the preamble, plus 4 or 5 bits of synchronizer delay, LOCK asserts to indicate the beginning of valid data output.

Applications Information

GPON Burst-Mode Timing

Internally, the MAX3634 requires five internal clock cycles (8x REFCLK) to initialize itself after receiving the

rest (BRST) signal. It then uses the next 8 bits of preamble (10101010) to measure the phase relationship between the reference clock and upstream data (after the internal logic has been reset), and 3 to 5 bits later begins outputting data. The time interval from BRST to the end of the preamble must be no less than 18 bits long. If the 8 bits of preamble that it uses to measure phase have been excessive pulse-width distortion, the phase measurement is in error.

The active edge of the reset input (BRST) must arrive at the MAX3634 after the TIA has finished its level recovery, but no sooner than 18 bits prior to the end of the (repeating 10 pattern) preamble, in order to provide adequate time for the MAX3634 to initialize, measure the phase, and load the output pipelines. This timing is shown in Figure 3.

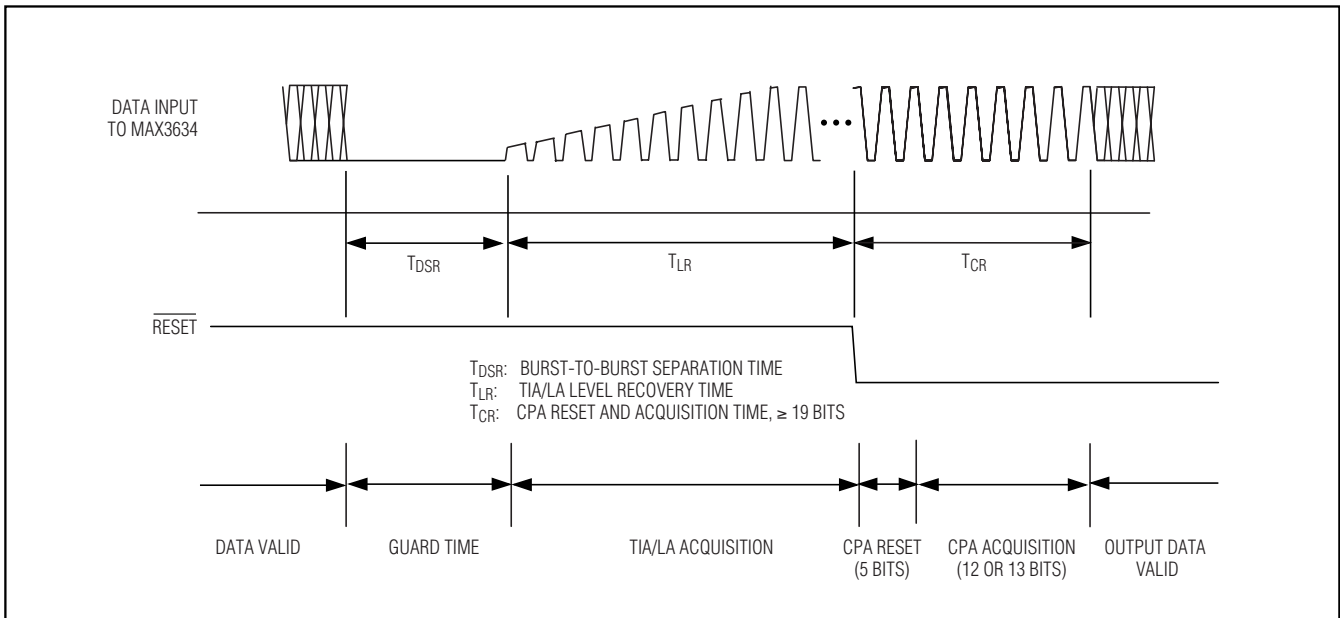
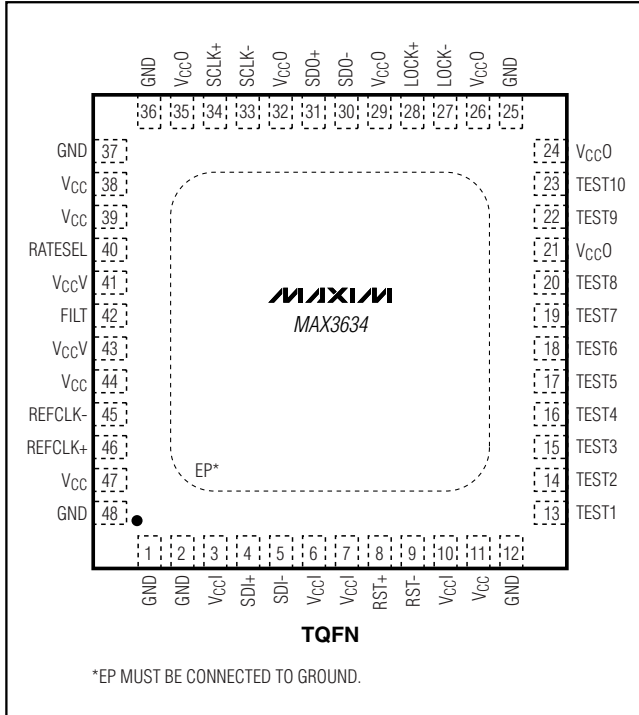

Figure 3. Clock Phase Aligner Operation Timing Diagram

622Mbps/1244Mbps Burst-Mode Clock Phase Aligner for GPON OLT Applications

Pin Configuration



Chip Information

TRANSISTOR COUNT: 10,805

PROCESS: Silicon Germanium BiCMOS

MAX3634

622Mbps/1244Mbps Burst-Mode Clock Phase Aligner for GPON OLT Applications

Package Information

(The package drawing(s) in this data sheet may not reflect the most current specifications. For the latest package outline information, go to www.maxim-ic.com/packages.)

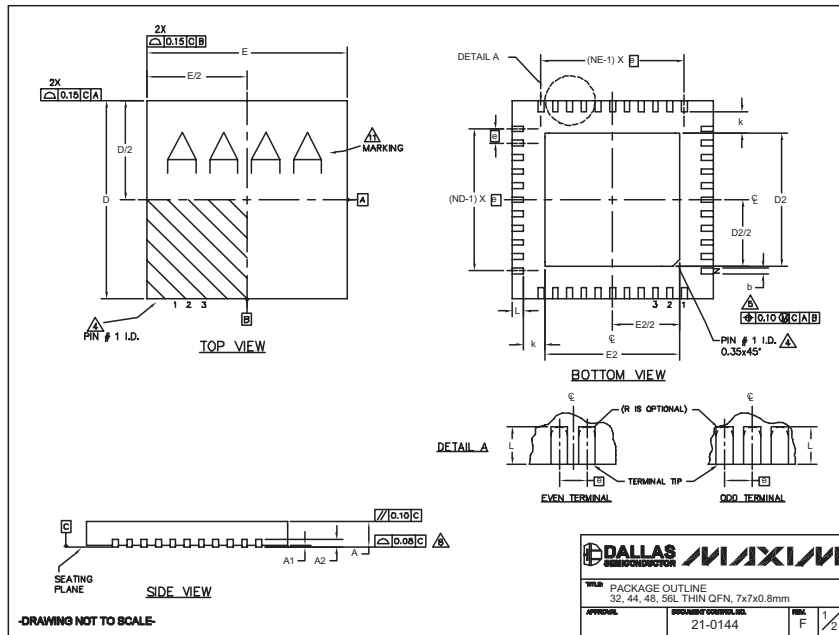

32, 44, 48L QFNLEPS

COMMON DIMENSIONS													EXPOSED PAD VARIATIONS										
PKG	32L 7x7			44L 7x7			48L 7x7			CUSTOM PKG. (T4877-1)			56L 7x7			PKG. CODES	DEPOPULATED LEADS	D2			E2		JEDEC MO220 DEV. C
	MIN.	NOM.	MAX.	MIN.	NOM.	MAX.	MIN.	NOM.	MAX.	MIN.	NOM.	MAX.	MIN.	NOM.	MAX.			MIN.	NOM.	MAX.	MIN.	MAX.	
A	0.70	0.75	0.80	0.70	0.75	0.80	0.70	0.75	0.80	0.70	0.75	0.80	0.70	0.75	0.80	13277-2	4.55	4.70	4.85	4.65	4.70	4.85	-
A1	0	0.02	0.05	0	0.02	0.05	0	0.02	0.05	0	0.02	0.05	0	-	0.05	13277-3	4.55	4.70	4.85	4.55	4.70	4.85	-
A2	0.20	REF.	-	0.20	REF.	-	0.20	REF.	-	0.20	REF.	-	0.20	REF.	-	14477-2	4.55	4.70	4.85	4.55	4.70	4.85	WROD-1
b	0.25	0.30	0.35	0.20	0.25	0.30	0.20	0.25	0.30	0.20	0.25	0.30	0.10	0.20	0.25	14477-3	4.55	4.70	4.85	4.55	4.70	4.85	WROD-1
D	6.90	7.00	7.10	6.90	7.00	7.10	6.90	7.00	7.10	6.90	7.00	7.10	6.90	7.00	7.10	14877-1**	4.20	4.30	4.40	4.20	4.30	4.40	-
E	6.90	7.00	7.10	6.90	7.00	7.10	6.90	7.00	7.10	6.90	7.00	7.10	6.90	7.00	7.10	14877-1**	4.20	4.30	4.40	4.20	4.30	4.40	-
e	0.85	BSC.	-	0.50	BSC.	-	0.50	BSC.	-	0.50	BSC.	-	0.40	BSC.	-	14877-3	4.95	5.10	5.25	4.95	5.10	5.25	-
k	0.25	-	-	0.25	-	-	0.25	-	-	0.25	-	-	0.25	-	-	14877-4	5.40	5.50	5.60	5.40	5.50	5.60	-
L	0.45	0.55	0.65	0.45	0.55	0.65	0.30	0.40	0.50	0.45	0.55	0.65	0.30	0.40	0.50	14877-5	2.40	2.50	2.60	2.40	2.50	2.60	-
N	32	-	-	44	-	-	48	-	-	44	-	-	56	-	-	14877-6	5.40	5.50	5.60	5.40	5.50	5.60	-
ND	8	-	-	11	-	-	12	-	-	10	-	-	14	-	-	14877-7	4.95	5.10	5.25	4.95	5.10	5.25	-
NE	8	-	-	11	-	-	12	-	-	12	-	-	14	-	-	14877N-1	5.40	5.50	5.60	5.40	5.50	5.60	-
																14877N-4	5.40	5.50	5.60	5.40	5.50	5.60	-
																14877N-6	5.40	5.50	5.60	5.40	5.50	5.60	-
																14877N-8	5.40	5.50	5.60	5.40	5.50	5.60	-
																T5677-1	5.40	5.50	5.60	5.40	5.50	5.60	-
																T5677-2	5.40	5.50	5.60	5.40	5.50	5.60	-

NOTES:

- DIMENSIONING & TOLERANCING CONFORM TO ASME Y14.5M-1994.
- ALL DIMENSIONS ARE IN MILLIMETERS. ANGLES ARE IN DEGREES.
- N IS THE TOTAL NUMBER OF TERMINALS.
- THE TERMINAL #1 IDENTIFIER AND TERMINAL NUMBERING CONVENTION SHALL CONFORM TO JEDEC 95-1 SPP-012. DETAILS OF TERMINAL #1 IDENTIFIER ARE OPTIONAL, BUT MUST BE LOCATED WITHIN THE ZONE INDICATED. THE TERMINAL #1 IDENTIFIER MAY BE EITHER A MOLD OR MARKED FEATURE.
- DIMENSION b APPLIES TO METALLIZED TERMINAL AND IS MEASURED BETWEEN 0.25 mm AND 0.30 mm FROM TERMINAL TIP.
- ND AND NE REFER TO THE NUMBER OF TERMINALS ON EACH D AND E SIDE RESPECTIVELY.
- DEPOPULATION IS POSSIBLE IN A SYMMETRICAL FASHION.
- COPLANARITY APPLIES TO THE EXPOSED HEAT SINK SLOG AS WELL AS THE TERMINALS.
- DRAWING CONFORMS TO JEDEC MO220 EXCEPT THE EXPOSED PAD DIMENSIONS OF T4877-1/-3/-4/-5/-6 & T5677-1.
- WARPAGE SHALL NOT EXCEED 0.10 mm.
- MARKING IS FOR PACKAGE ORIENTATION REFERENCE ONLY.
- NUMBER OF LEADS SHOWN ARE FOR REFERENCE ONLY.

** NOTE: T4877-1 IS A CUSTOM 48L PKG. WITH 4 LEADS DEPOPULATED. TOTAL NUMBER OF LEADS ARE 44.

The drawing also includes the Dallas Semiconductor logo and the text 'PACKAGE OUTLINE 32-44, 48, 56L THIN QFN, 7x7x0.8mm' and '21-0144'. A callout 'DRAWING NOT TO SCALE' is present.

Maxim cannot assume responsibility for use of any circuitry other than circuitry entirely embodied in a Maxim product. No circuit patent licenses are implied. Maxim reserves the right to change the circuitry and specifications without notice at any time.

8 Maxim Integrated Products, 120 San Gabriel Drive, Sunnyvale, CA 94086 408-737-7600