



Chipsmall Limited consists of a professional team with an average of over 10 year of expertise in the distribution of electronic components. Based in Hongkong, we have already established firm and mutual-benefit business relationships with customers from,Europe,America and south Asia,supplying obsolete and hard-to-find components to meet their specific needs.

With the principle of "Quality Parts,Customers Priority,Honest Operation,and Considerate Service",our business mainly focus on the distribution of electronic components. Line cards we deal with include Microchip,ALPS,ROHM,Xilinx,Pulse,ON,Everlight and Freescale. Main products comprise IC,Modules,Potentiometer,IC Socket,Relay,Connector.Our parts cover such applications as commercial,industrial, and automotives areas.

We are looking forward to setting up business relationship with you and hope to provide you with the best service and solution. Let us make a better world for our industry!



## Contact us

Tel: +86-755-8981 8866 Fax: +86-755-8427 6832

Email & Skype: info@chipsmall.com Web: www.chipsmall.com

Address: A1208, Overseas Decoration Building, #122 Zhenhua RD., Futian, Shenzhen, China



## General Description

The MAX40075/MAX40088 are wideband, low-noise, low-input bias current operational amplifiers offering rail-to-rail outputs and single-supply operation down to 2.7V. They draw 2.2mA of quiescent supply current per amplifier when enabled. Ultra-low distortion (0.0002% THD+N), as well as low input voltage-noise density ( $4.2\text{nV}/\sqrt{\text{Hz}}$ ) and low input current-noise density ( $0.5\text{fA}/\sqrt{\text{Hz}}$ ). The low input bias current and low noise together with the wide bandwidth will suit transimpedance amplifiers and imaging applications.

For power conservation, the MAX40075/MAX40088 offer a low-power shutdown mode that reduces supply current to  $0.1\mu\text{A}$  and places the amplifiers outputs into a high impedance state. These amplifiers have outputs which swing rail-to-rail and their input common-mode voltage range includes ground. The MAX40075 is unity-gain stable with a gain-bandwidth product of 10MHz. The MAX40088 is gain-of-5 stable with a gain-bandwidth product of 42MHz.

## Applications

- ADC Buffers
- DAC Output Amplifiers
- Low-Noise Microphone/Preamplifiers
- Digital Scales
- Strain Gauges/Sensor Amplifiers
- Trans Impedance Amplifiers
- Medical Instrumentation

[Ordering Information](#) appears at end of data sheet.

## Benefits and Features

- Low Input Voltage-Noise Density:  $4.2\text{nV}/\sqrt{\text{Hz}}$  at 30kHz
- Low Input Current-Noise Density:  $0.5\text{fA}/\sqrt{\text{Hz}}$
- Low Input Bias Current:  $<1\text{pA}$  (Typical)
- Low Distortion: 0.00035% or -109dB THD+N (1k $\Omega$  Load)
- Single-Supply Operation from +2.7V to +5.5V
- Input Common-Mode Voltage Range Includes Ground
- Rail-to-Rail Output Swings with a 1k $\Omega$  Load
- 10MHz GBW Product, Unity-Gain Stable (MAX40075 Only)
- 42MHz GBW Product, Gain  $\geq 5\text{V/V}$  (MAX40088 Only)
- Excellent DC Characteristics: Input  $V_{OS} \leq 70\mu\text{V}$
- Low-Power Shutdown Mode: Reduces Supply Current to  $\leq 1\mu\text{A}$
- Available in Space-Saving 6-SOT23 and 6-WLP Packages

## THD+N Performance

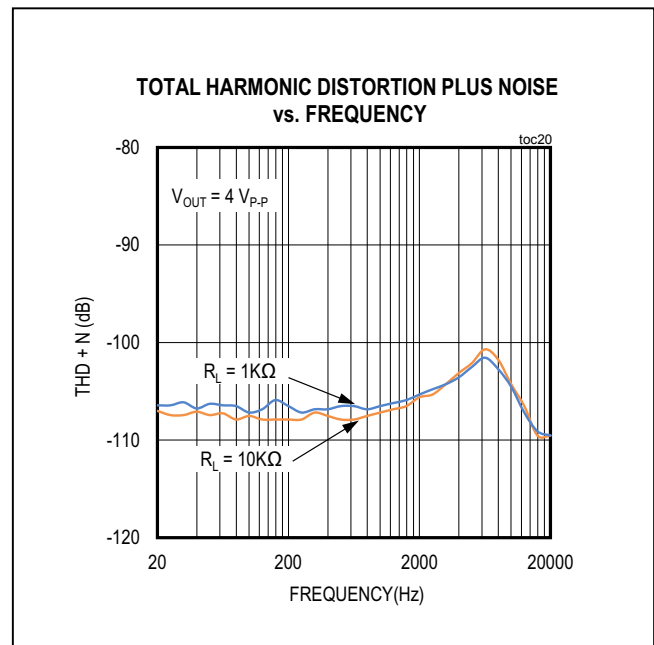

### Absolute Maximum Ratings

Input Differential Voltage		Continuous Power Dissipation	
MAX40075/MAX40088 (continuous)	-3V to +3V	SOT23-6 (derate 8.7mW/°C at +70°C)	696mW
MAX40075/MAX40088 (transient, 10s)	-6V to +6V	6-Bump WLP (derate 10.19mW/°C at +70°C)	815mW
Power-Supply Voltage (V <sub>DD</sub> to V <sub>SS</sub> )	-0.3V to +6V	Storage Temperature Range	-65°C to +150°C
Analog Input Voltage (IN+, IN-)	V <sub>SS</sub> -0.3V to V <sub>DD</sub> +0.3V	Lead Temperature (soldering, 10s)	+300°C
SHDN Input Voltage (SHDN)	V <sub>SS</sub> -0.3V to +6V	Soldering Temperature (reflow)	+260°C
Continuous Input Current (IN+, IN-)	±20mA		
Output Short-Circuit Duration to Either Supply	Continuous		
Operating Temperature Range	-40°C to 125°C		

Stresses beyond those listed under "Absolute Maximum Ratings" may cause permanent damage to the device. These are stress ratings only, and functional operation of the device at these or any other conditions beyond those indicated in the operational sections of the specifications is not implied. Exposure to absolute maximum rating conditions for extended periods may affect device reliability.

### Package Information

#### 6-SOT23

PACKAGE CODE	U6+1
Outline Number	<a href="#">21-0058</a>
Land Pattern Number	<a href="#">90-0175</a>
<b>Thermal Resistance, Single-Layer Board:</b>	
Junction-to-Ambient (θ <sub>JA</sub> )	115°C/W
Junction-to-Case (θ <sub>JC</sub> )	80°C/W

#### 6-WLP

PACKAGE CODE	N60F1+1
Outline Number	<a href="#">21-100174</a>
Land Pattern Number	Refer to <a href="#">Application Note 1891</a>
<b>Thermal Resistance, Single-Layer Board:</b>	
Junction-to-Ambient (θ <sub>JA</sub> )	98.06°C/W
Junction-to-Case (θ <sub>JC</sub> )	N/A

For the latest package outline information and land patterns (footprints), go to [www.maximintegrated.com/packages](http://www.maximintegrated.com/packages). Note that a "+", "#", or "-" in the package code indicates RoHS status only. Package drawings may show a different suffix character, but the drawing pertains to the package regardless of RoHS status.

Package thermal resistances were obtained using the method described in JEDEC specification JESD51-7, using a four-layer board. For detailed information on package thermal considerations, refer to [www.maximintegrated.com/thermal-tutorial](http://www.maximintegrated.com/thermal-tutorial).



## Electrical Characteristics

( $V_{DD}=+5V$ ,  $V_{SS}=0V$ ,  $V_{CM}=2.5V$ ,  $\overline{SHDN} = V_{DD}$ ,  $V_{OUT}=V_{DD}/2$ ,  $R_L$ =tied to  $V_{DD}/2$ ,  $T_A=-40^\circ C$  to  $+125^\circ C$ , unless otherwise noted. Typical values are at  $T_A = +25^\circ C$ . (Note 1) )

PARAMETER	SYMBOL	CONDITIONS	MIN	TYP	MAX	UNITS
Supply Voltage Range		Guaranteed by PSRR test	2.7		5.5	V
Quiescent Supply Current, per amplifier		$V_{DD} = 3.3V$		2.2	3.0	mA
		$V_{DD} = 5V$		2.5	3.3	
Power-Up time		$V_{DD} = 0$ to $5V$ step, $V_{OUT} \rightarrow 2.5V \pm 1\%$		13		$\mu s$
Shutdown Supply Current		Overtemperature, to $125^\circ C$		0.4	1.7	$\mu A$
Input Offset Voltage		At $25^\circ C$		30	150	$\mu V$
		Over the full temperature range			450	
Input Offset Drift		Over temperature, to $125^\circ C$		0.3	3	$\mu V/^\circ C$
Input Bias Current (Note 2)				1	2300	pA
Input offset Current (Note 2)				0.2	500	pA
Differential Input Resistance				1000		G $\Omega$
Input Capacitance		Either input, over entire CMIR		10		pF
Input Common Mode Range		Guaranteed by CMRR test, at $25^\circ C$	-0.2		$V_{DD} - 1.5$	V
		Guaranteed by CMRR test, full temperature range	-0.1		$V_{DD} - 1.5$	
Common Mode Rejection Ratio		DC, $-0.2V < CMIR < V_{DD} - 1.5V$ , at $25^\circ C$	90	109		dB
		DC, $-0.1V < CMIR < V_{DD} - 1.5V$ , full temperature range	89			
Common Mode Rejection Ratio, AC		100 mV <sub>P-P</sub> 1MHz, with DC in 0V to $V_{DD} - 2V$ range		60		dB
Power Supply Rejection Ratio, DC		DC, $2.7V < V_{DD} < 5.5V$	90	107		dB
Power Supply Rejection Ratio, AC		AC, 100mV <sub>PP</sub> 1MHz, superimposed on $V_{DD}$		40		dB
Open-Loop Gain		$R_L = 10k\Omega$ to $V_{DD}/2$ , $V_{OUT} = 200mV$ to $V_{DD}-250mV$	93	114		dB
		$R_L = 1k\Omega$ to $V_{DD}/2$ , $V_{OUT} = 200mV$ to $V_{DD}-250mV$	87	109		
		$R_L = 500\Omega$ to $V_{DD}/2$ , $V_{OUT} = 200mV$ to $V_{DD}-250mV$	85	107		
Output Voltage Swing High		$R_L = 10k\Omega$ to $V_{DD}/2$ , $V_{DD} - V_{OH}$		3	10	mV
		$R_L = 1k\Omega$ to $V_{DD}/2$ , $V_{DD} - V_{OH}$		30	60	
		$R_L = 500\Omega$ to $V_{DD}/2$ , $V_{DD} - V_{OH}$		60	120	
Output Voltage Swing Low		$R_L = 10k\Omega$ to $V_{DD}/2$ , $V_{DD} - V_{SS}$		3	10	mV
		$R_L = 1k\Omega$ to $V_{DD}/2$ , $V_{OL} - V_{SS}$		30	60	
		$R_L = 500\Omega$ to $V_{DD}/2$ , $V_{OL} - V_{SS}$		60	120	
Short-Circuit Current		Shorted to either power supply		48		mA
Output Leakage Current When Shut Down		$V_{SS} < V_{OUT} < V_{DD}$		0.01	1	$\mu A$
Shut-Down Input Low level					$0.3 \times V_{DD}$	V

### Electrical Characteristics (continued)

( $V_{DD}=+5V$ ,  $V_{SS}=0V$ ,  $V_{CM}=2.5V$ ,  $\overline{SHDN}=V_{DD}$ ,  $V_{OUT}=V_{DD}/2$ ,  $R_L$ =tied to  $V_{DD}/2$ ,  $T_A=-40^\circ C$  to  $+125^\circ C$ , unless otherwise noted. Typical values are at  $T_A = +25^\circ C$ . (Note 1) )

PARAMETER	SYMBOL	CONDITIONS	MIN	TYP	MAX	UNITS
Shut-Down Input High level			$0.7 \times V_{DD}$			V
Shut-Down Input Bias				0.01	1	$\mu A$
-3dB Bandwidth		Unity-gain version, $A_v = +1$		10		MHz
		Gain of 5 stable, $A_v = +5$		42		
Phase Margin		Unity-gain version, $A_v = +1$		70		°
		Gain of 5 stable, $A_v = +5$		80		
Gain Margin				12		dB
Slew Rate		Unity-gain version, $A_v = +1$		3		V/ $\mu s$
		Gain of 5 stable, $A_v = +5$		10		
Settling Time		Unity-gain version, $A_v = +1$ , to 0.01%, $V_{OUT} = 2V$ step		2		$\mu s$
		Gain of 5 Stable, $A_v = +5$ , to 0.01%, $V_{OUT} = 2V$ step		2		
Stable Capacitive Load		Guaranteed stability over all conditions		50		pF
Integrated 1/f Input Voltage Noise		0.1Hz to 10Hz		1.7		$\mu V_{PP}$
Input Voltage Noise Density		f = 10Hz		260		nV/ $\sqrt{Hz}$
		f = 1kHz		5.5		
		f = 30kHz		4.2		
Input Current Noise Density		f = 1kHz		0.5		fA/ $\sqrt{Hz}$
Total Harmonic Distortion + Noise		Unity-gain version, $A_v = +1$ , $V_{OUT} = 4V_{PP}$ , 10k $\Omega$ to GND, 1kHz		-114.0		dBc
		Unity-gain version, $A_v = +1$ , $V_{OUT} = 4V_{PP}$ , 10k $\Omega$ to GND, 20kHz		-103.1		
		Unity-gain version, $A_v = +1$ , $V_{OUT} = 4V_{PP}$ , 1k $\Omega$ to GND, 1kHz		-114.0		
		Unity-gain version, $A_v = +1$ , $V_{OUT} = 4V_{PP}$ , 1k $\Omega$ to GND, 20kHz		-100.0		
		Gain of 5 version, $A_v = +5$ , $V_{OUT} = 4V_{PP}$ , 10k $\Omega$ to GND, 1kHz		-108.0		
		Gain of 5 version, $A_v = +5$ , $V_{OUT} = 4V_{PP}$ , 10k $\Omega$ to GND, 20kHz		-110		
		Gain of 5 version, $A_v = +5$ , $V_{OUT} = 4V_{PP}$ , 1k $\Omega$ to GND, 1kHz		-106.0		
		Gain of 5 version, $A_v = +5$ , $V_{OUT} = 4V_{PP}$ , 1k $\Omega$ to GND, 20kHz		-110		
Electromagnetic Interference Rejection Ratio		$V_{RF\_PP} = 100mV$ , F = 900MHz to 2400MHz		55		dB

**Note 1:** Limits are 100% tested at  $T_A = +25^\circ C$ . Limits over the operating temperature range and relevant supply voltage range are guaranteed by design and characterization.

**2:** Guaranteed by design and bench characterization.

Typical Operating Characteristics

$V_{DD} = +5V$ ,  $V_{SS} = 0V$ ,  $V_{CM} = V_{DD}/2$ ,  $R_L = 10k\Omega$  to  $V_{DD}/2$ ,  $C_L = 10pF$  to GND,  $T_A = +25^\circ C$ , unless otherwise noted.

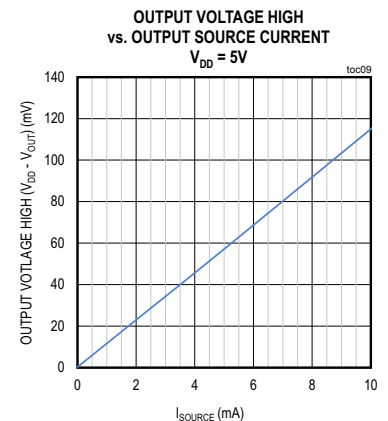
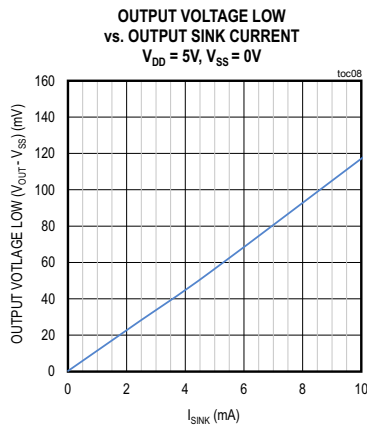
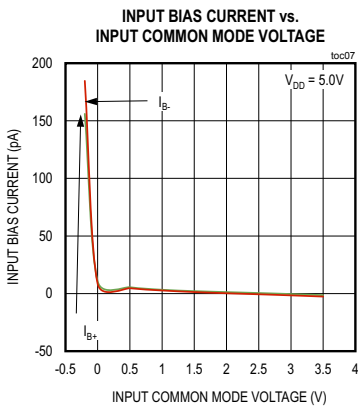
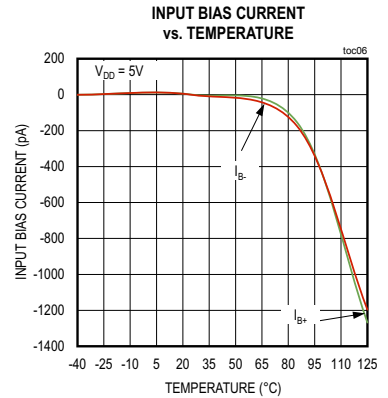
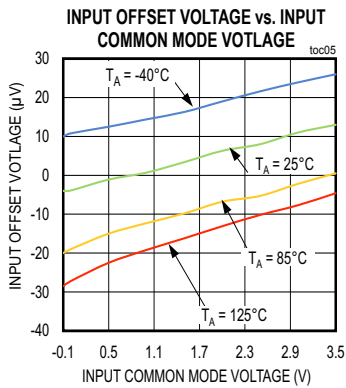
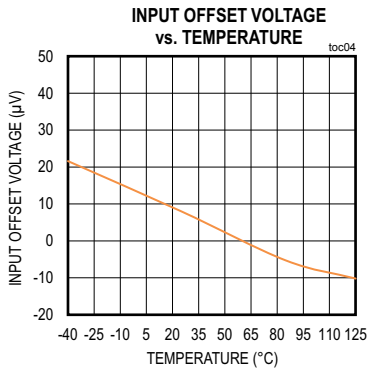
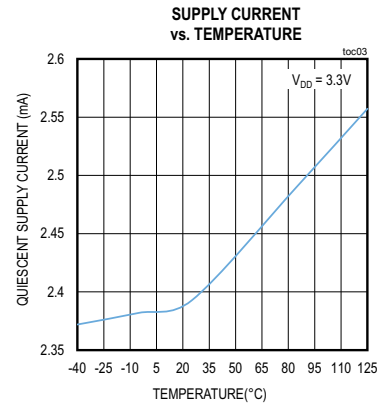
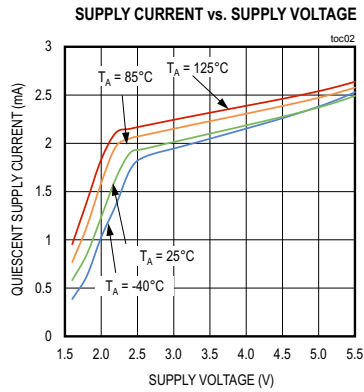
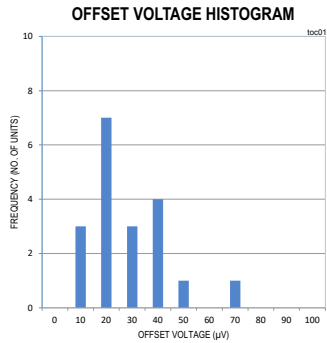

Typical Operating Characteristics (continued)

$V_{DD} = +5V$ ,  $V_{SS} = 0V$ ,  $V_{CM} = V_{DD}/2$ ,  $R_L = 10k\Omega$  to  $V_{DD}/2$ ,  $C_L = 10pF$  to GND,  $T_A = +25^\circ C$ , unless otherwise noted.

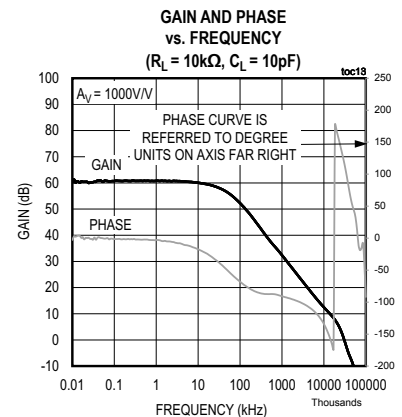
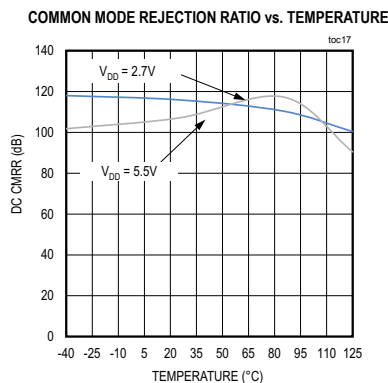
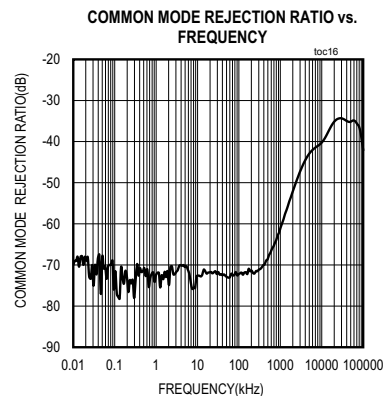
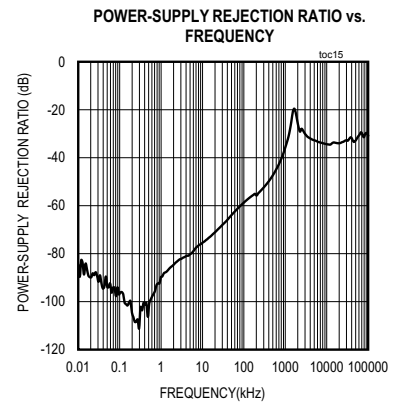
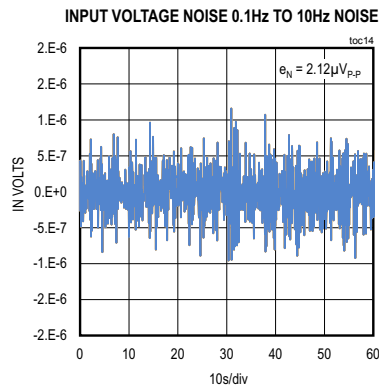
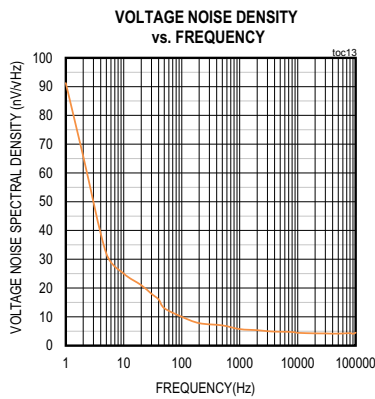
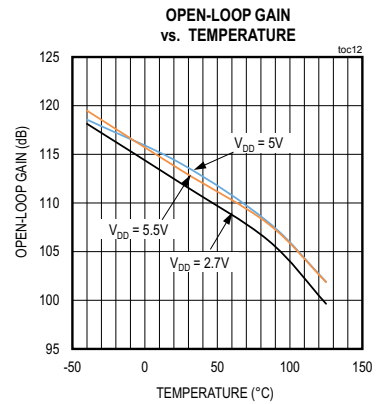
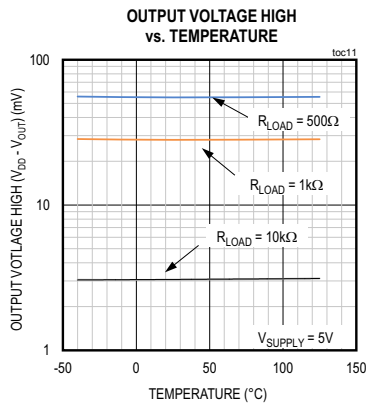
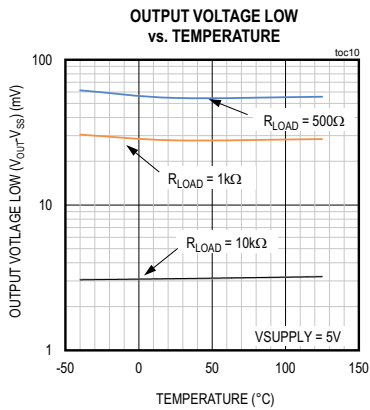

Typical Operating Characteristics (continued)

$V_{DD} = +5V$ ,  $V_{SS} = 0V$ ,  $V_{CM} = V_{DD}/2$ ,  $R_L = 10k\Omega$  to  $V_{DD}/2$ ,  $C_L = 10pF$  to GND,  $T_A = +25^\circ C$ , unless otherwise noted.

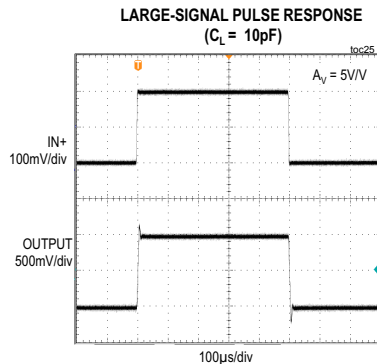
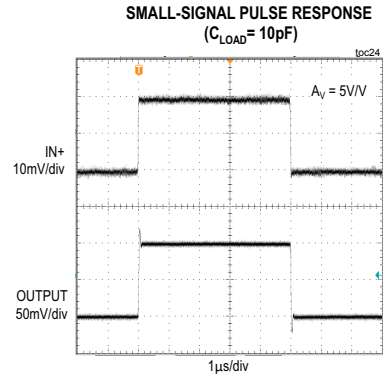
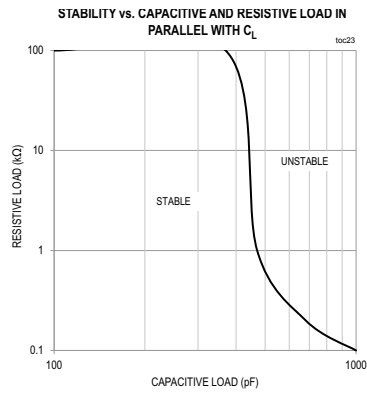
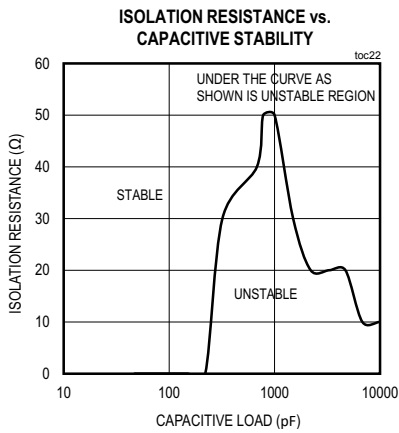
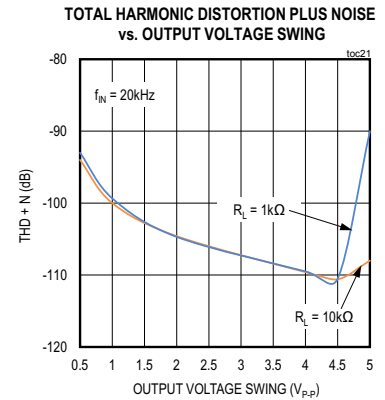
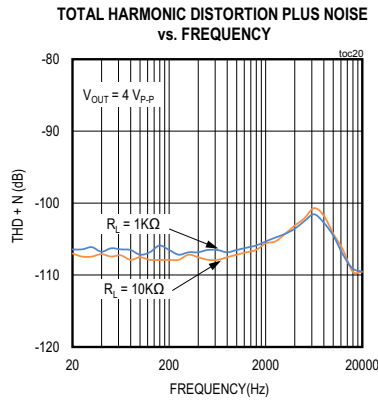
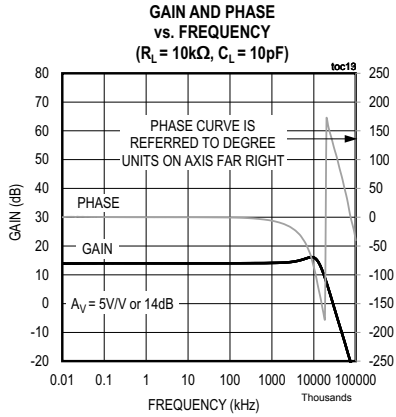



Pin Configurations

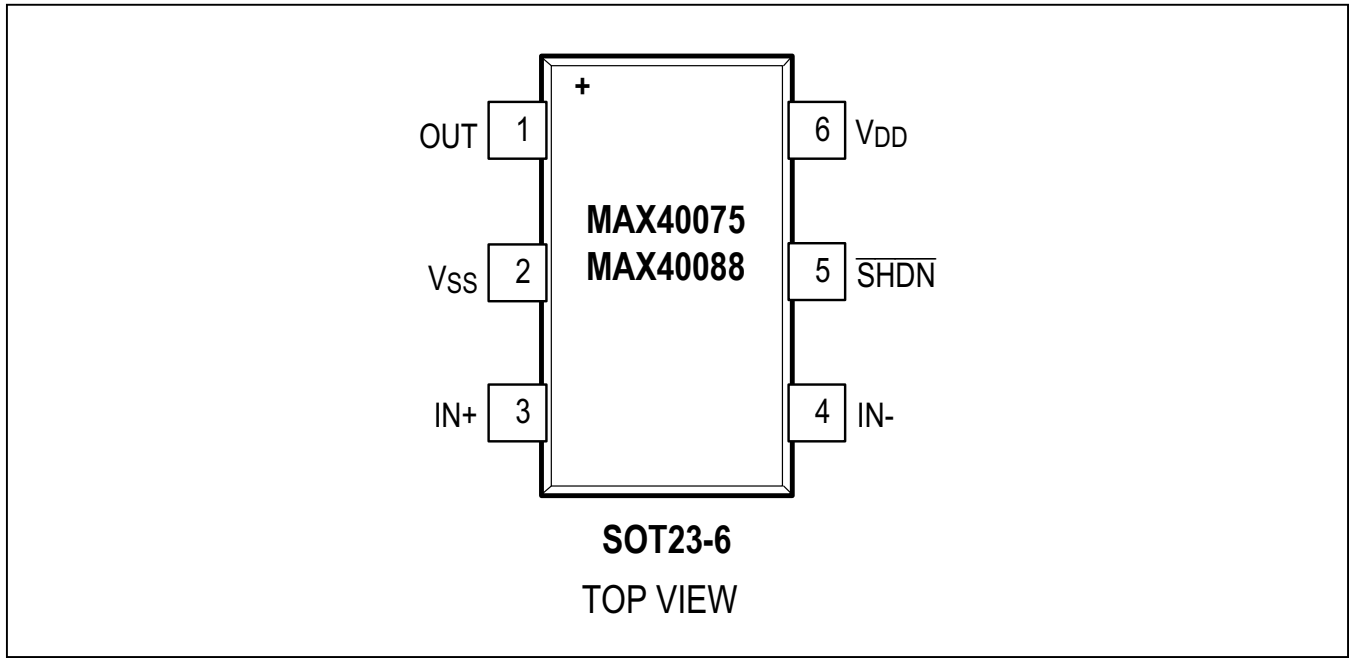

Pin Description

PIN		NAME	FUNCTION
SOT23	6-WLP		
1	A3	OUT	Amplifier Output
2	A2	V <sub>SS</sub>	Negative Supply. Connect to ground for single-supply operation.
3	A1	IN+	Non-Inverting Amplifier Input
4	B1	IN-	Inverting Amplifier Input
5	B2	$\overline{\text{SHDN}}$	Shutdown, Active Low. Connect to V <sub>DD</sub> for normal operation (amplifier enabled)
6	B3	V <sub>DD</sub>	Positive Supply. Connect 0.1μF and 4.7μF from V <sub>DD</sub> to V <sub>SS</sub> .

### Functional Diagrams

#### Internal ESD protection

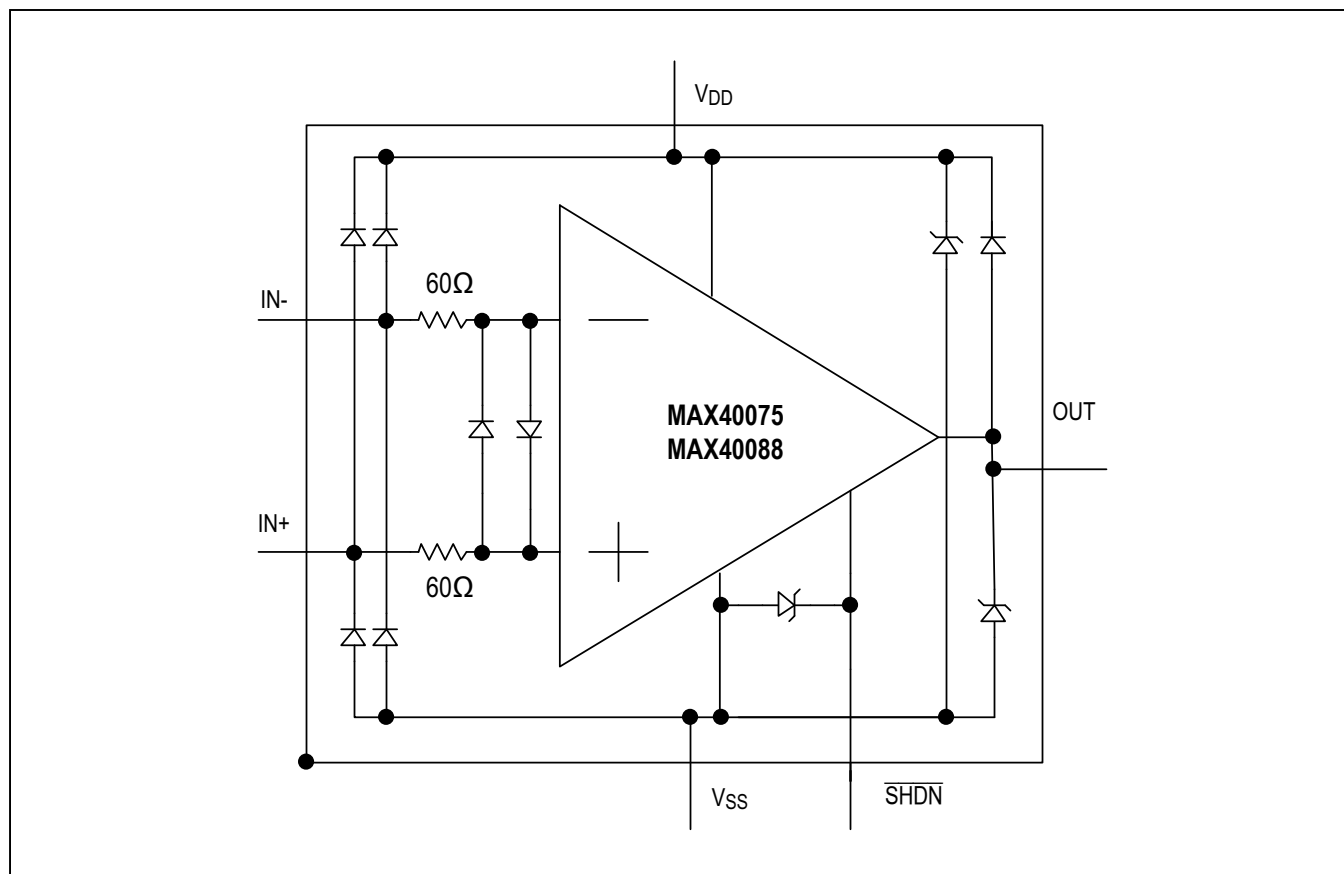

Figure 1. Internal ESD protection

## Detailed Description

The MAX40075/MAX40088 single-supply operational amplifiers feature ultra-low noise and distortion. Their low distortion and low noise make them ideal for use as pre-amplifiers in wide dynamic range applications, such as 16-bit analog-to-digital converters. Their high input impedance and low noise are also useful for signal conditioning of high-impedance sources, such as piezo-electric transducers.

These devices have true rail-to-rail output operation, drive output resistive loads as low as 1k $\Omega$  while maintaining DC accuracy and can drive capacitive loads up to 200pF without any oscillation. The input common-mode voltage range extends from 0.2V below  $V_{SS}$  to ( $V_{DD} - 1.5V$ ). The push-pull output stage maintains excellent DC characteristics, while delivering up to  $\pm 20$  mA of source/sink output current.

The MAX40075 is unity-gain stable, while the MAX40088 is a decompensated version that has higher slew rate and is stable for Gain  $\geq 5V/V$ . Both devices feature a low-power shutdown mode, which reduces the supply current to 0.1 $\mu$ A and places amplifiers outputs into a high-impedance state.

### Low Noise

The amplifiers input-referred voltage noise density is dominated by flicker noise (also known as 1/f noise) at lower frequencies and by thermal noise at higher frequencies. Overall thermal noise contribution is affected by the parallel combination of resistive feedback network ( $R_F || R_G$ ) depicted in [Figure 2](#). These resistors should be reduced in cases where system bandwidth is large and thermal noise is dominant. Noise contribution factor can be reduced with increased gain settings.

For example, the input noise voltage density ( $e_N$ ) of the circuit with  $R_F = 100k\Omega$ ,  $R_G = 10k\Omega$  (in [Figure 2](#)) with Gain = 10V/V non-inverting configuration is  $e_N = 12nV/\sqrt{Hz}$ .  $e_N$  can be reduced to 6nV/ $\sqrt{Hz}$  by choosing  $R_F = 10k\Omega$ ,  $R_G = 1k\Omega$  (in [Figure 2](#)) with Gain = 10V/V, as before, but at the expense of higher current consumption and higher distortion. Having a gain of 100V/V with  $R_F = 100k\Omega$ ,  $R_G = 1k\Omega$  (in [Figure 2](#)), input referred voltage noise density is still a low 6nV/ $\sqrt{Hz}$ .

### Low Distortion

Many factors can affect the noise and distortion performance of the amplifier based on the design choices made. The following guidelines offer valuable information on the impact of design choices on Total Harmonic Distortion (THD). Choosing correct feedback and gain resistor values for a particular application can be a very important factor

in reducing THD. In general, the smaller the closed-loop gain, the smaller the THD generated, especially when driving heavy resistive loads (e.g., smaller resistive load with higher output current). Operating the device near or above the full-power bandwidth significantly degrades distortion.

Referencing the load to either supply also improves the amplifier distortion performance, because only one of the MOSFETs of the push-pull output stage drives the output. Referencing the load to mid-supply increases the amplifier distortion for a given load and feedback setting (see the *Total Harmonic Distortion vs. Frequency* graph in [Typical Operating Characteristics](#)).

For gains  $\geq 5V/V$ , the decompensated MAX40088 deliver the best distortion performance as they have a higher slew rate and provide a higher amount of loop gain for a given closed-loop gain setting. Capacitive loads below 100pF do not significantly affect distortion results. Distortion performance is relatively constant over supply voltages.

### Using a Feed-Forward Compensation Capacitor, $C_Z$

The amplifier's input capacitance is 10pF and if the resistance seen by the inverting input is large (in [Figure 2](#)) as a result of feedback network, this resistance and capacitance combination can introduce a pole within the amplifier's bandwidth resulting in reduced phase margin. Compensate the reduced phase margin by introducing a feed-forward capacitor ( $C_Z$ ) between the inverting input and the output (shown in [Figure 2](#)). This effectively cancels the pole from the inverting input of the amplifier. Choose the value of  $C_Z$  as follows:

$$C_Z = 10 \times (R_F/R_G) \text{ [pF]}$$

In the unity-gain stable MAX40075, the use of right  $C_Z$  is most important for closed loop non-inverting gain  $A_V = +2V/V$ , and inverting gain  $A_V = -1V/V$ .

In the decompensated MAX40088,  $C_Z$  is most important for closed loop gain  $A_V = +10V/V$ .

Using a slightly smaller  $C_Z$  than suggested by the formula above achieves a higher bandwidth at the expense of reduced phase and gain margin. As a general guideline, consider using  $C_Z$  for cases where  $R_G || R_F$  is greater than 20k $\Omega$  (for MAX40075) and greater than 5k $\Omega$  (for MAX40088).

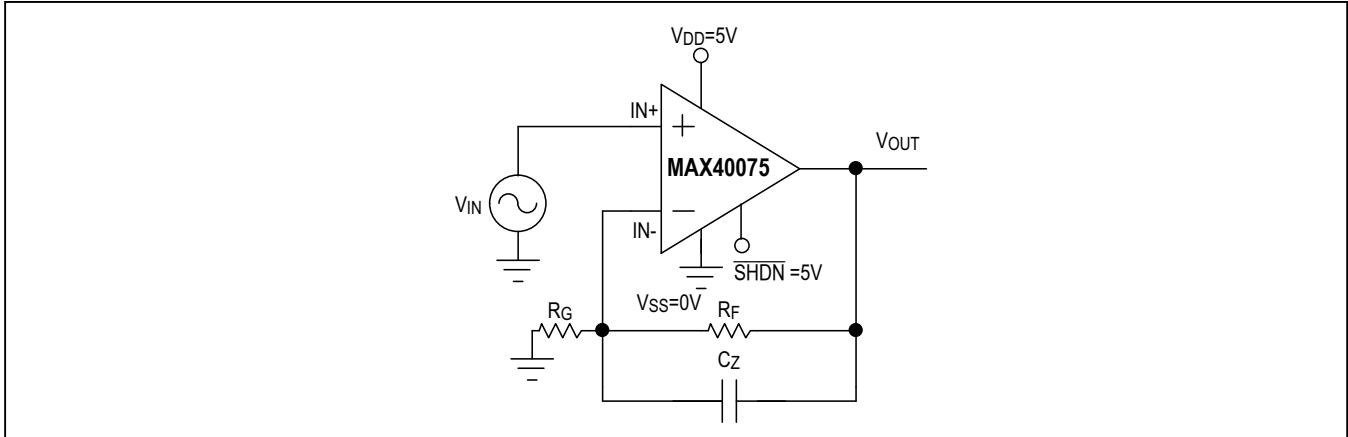

Figure 2. Adding Feed-Forward Compensation

## Applications Information

### Applications Information

The MAX40075/MAX40088 combine good driving capability with ground-sensing input and rail-to-rail output operation. With their low distortion and low noise, these devices are ideal for use in ADC buffers, DAC output buffers, medical instrumentation systems and other noise-sensitive applications.

### Ground-Sensing and Rail-to-Rail Outputs

The common-mode input range of these devices extends below ground over temperature that offers excellent common mode rejection and can be used in low side current sensing applications. These devices are guaranteed not to undergo phase-reversal when the input is overdriven over input common mode voltage range as shown in [Figure 3](#).

[Figure 4](#) showcases the true rail-to-rail output operation of the amplifier, configured with  $A_V = 5V/V$ . The output swings to within 8mV of the supplies with a 10k $\Omega$  load, making the devices ideal in low-supply voltage applications.

### Power Supplies and Layout

The MAX40075/MAX40088 operate from a single +2.7V to +5.5V power supply or from dual supplies of  $\pm 1.35V$  to  $\pm 2.75V$ . For single-supply operation, bypass the  $V_{DD}$  power supply pin with a 0.1 $\mu F$  ceramic capacitor placed close to the  $V_{DD}$  pin. If operating from dual supplies, bypass both  $V_{DD}$  and  $V_{SS}$  supply pins with 0.1 $\mu F$  ceramic capacitor to ground. If additional decoupling is needed add another 4.7 $\mu F$  or 10 $\mu F$  where supply voltage is applied on PCB.

Good layout improves performance by decreasing the amount of stray capacitance and noise at the op amp inputs and output. To decrease stray capacitance, minimize PC board trace lengths and resistor leads, and place external components close to the op amp's pins.

### Typical Application Circuit

The [Typical Application Circuits](#) shows the single MAX40075 configured as an output buffer for the MAX5541 16-bit DAC. Because the MAX5541 has an unbuffered voltage output, the input bias current of the op amp used must be less than 6nA to maintain 16-bit accuracy. This family of amplifiers have an input bias current of only 2.3nA (max) over temperature, virtually eliminating this as a source of error. In addition, the MAX40075 has excellent open-loop gain and common-mode rejection, making this an excellent output buffer amplifier.

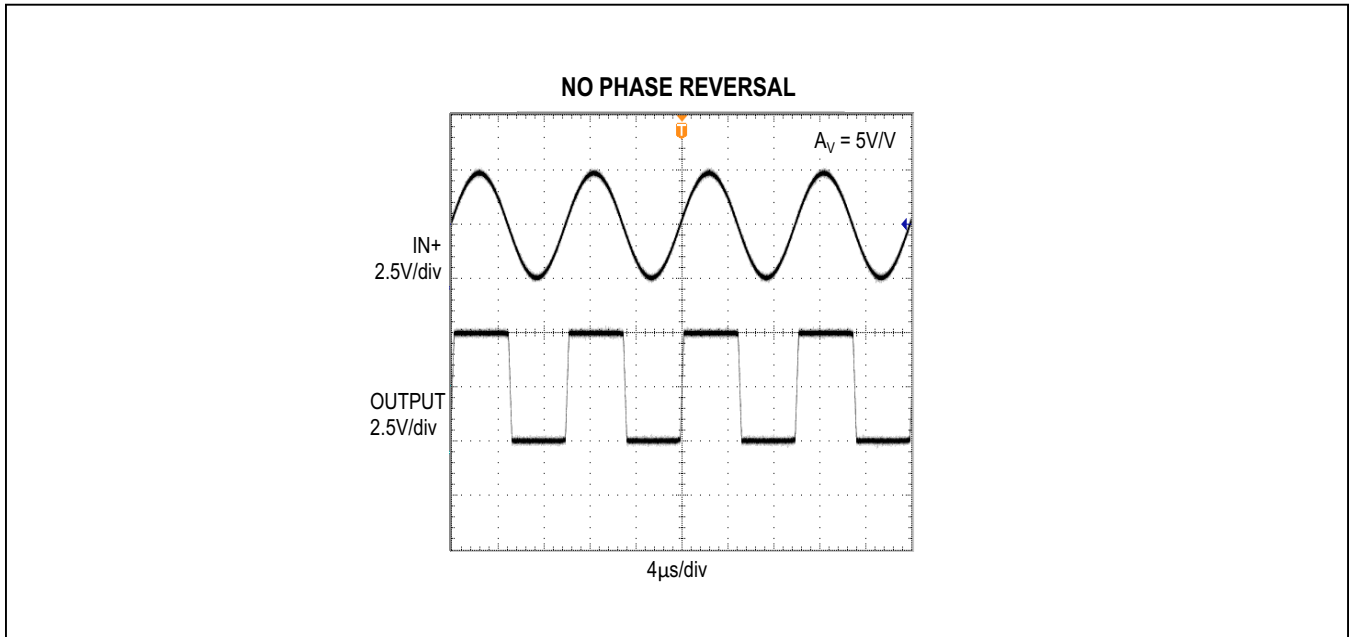

Figure 3. Scope Plot Showing Overdriven Input with No Phase Reversal

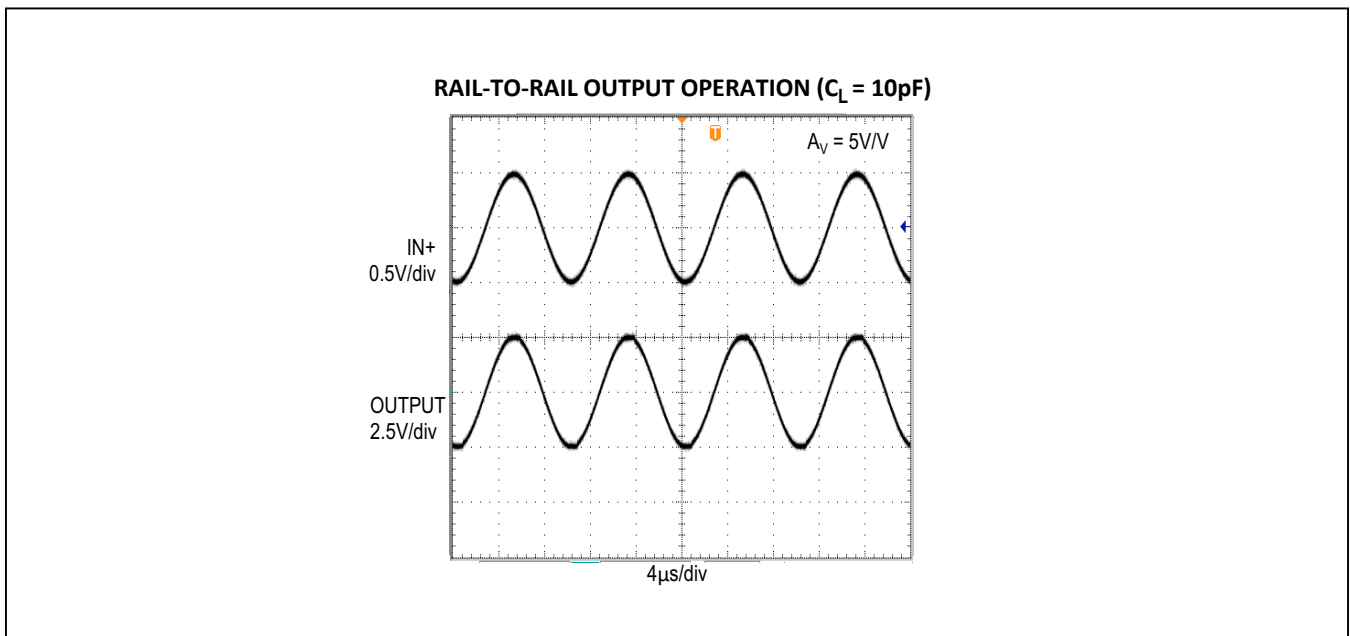
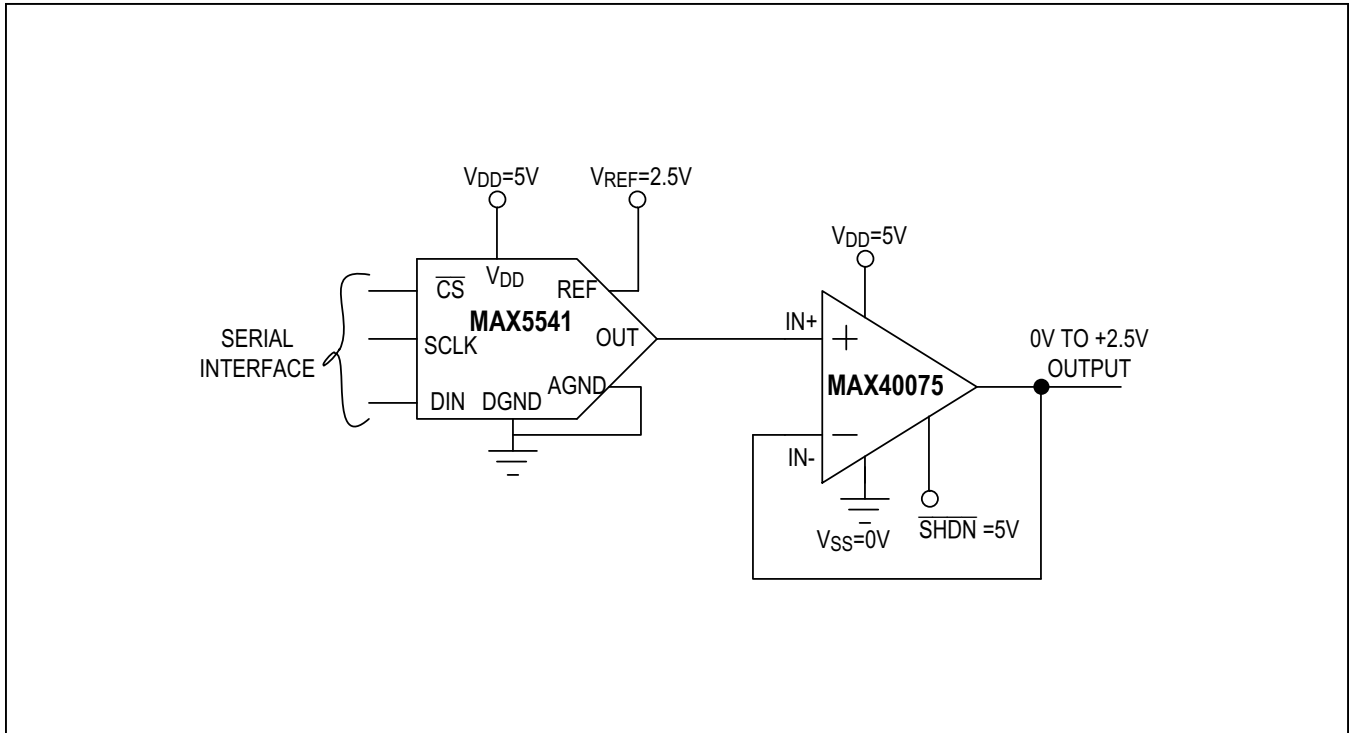

Figure 4. Rail-to-Rail Output Operation with  $10K\Omega$  and  $A_V = 5V/V$



Typical Application Circuit



Ordering Information

PART NUMBER	TEMP RANGE	PIN-PACKAGE	STABLE GAIN (V/V)	BW	TOP MARK
MAX40075ANT+T*	-40°C to +125°C	6-WLP	1	10MHz	—
MAX40075AUT+T	-40°C to +125°C	6-SOT23	1	10MHz	ACVD
MAX40088ANT+T*	-40°C to +125°C	6-WLP	5	42MHz	—
MAX40088AUT+T	-40°C to +125°C	6-SOT23	5	42MHz	ACVE

\* Future Product—Contact Maxim for availability.  
 + Denotes a lead(Pb)-free/RoHS-compliant package.  
 T Denotes tape-and-reel.

Chip Information

PROCESS: BiCMOS

## Revision History

REVISION NUMBER	REVISION DATE	DESCRIPTION	PAGES CHANGED
0	6/17	Initial release	—
1	7/17	Updated <i>Typical Operating Characteristics</i> section	5, 6
2	12/17	Updated <i>Ordering Information</i> table	13

For pricing, delivery, and ordering information, please contact Maxim Direct at 1-888-629-4642, or visit Maxim Integrated's website at [www.maximintegrated.com](http://www.maximintegrated.com).

Maxim Integrated cannot assume responsibility for use of any circuitry other than circuitry entirely embodied in a Maxim Integrated product. No circuit patent licenses are implied. Maxim Integrated reserves the right to change the circuitry and specifications without notice at any time. The parametric values (min and max limits) shown in the Electrical Characteristics table are guaranteed. Other parametric values quoted in this data sheet are provided for guidance.