



Chipsmall Limited consists of a professional team with an average of over 10 year of expertise in the distribution of electronic components. Based in Hongkong, we have already established firm and mutual-benefit business relationships with customers from,Europe,America and south Asia,supplying obsolete and hard-to-find components to meet their specific needs.

With the principle of “Quality Parts,Customers Priority,Honest Operation,and Considerate Service”,our business mainly focus on the distribution of electronic components. Line cards we deal with include Microchip,ALPS,ROHM,Xilinx,Pulse,ON,Everlight and Freescale. Main products comprise IC,Modules,Potentiometer,IC Socket,Relay,Connector.Our parts cover such applications as commercial,industrial, and automotives areas.

We are looking forward to setting up business relationship with you and hope to provide you with the best service and solution. Let us make a better world for our industry!



Contact us

Tel: +86-755-8981 8866 Fax: +86-755-8427 6832

Email & Skype: info@chipsmall.com Web: www.chipsmall.com

Address: A1208, Overseas Decoration Building, #122 Zhenhua RD., Futian, Shenzhen, China





350MHz/250MHz, 2-Channel Video Multiplexer-Amplifiers

General Description

Features

The MAX4158/MAX4159/MAX4258/MAX4259 are wide-band, 2-channel, noninverting video amplifiers with input multiplexing, capable of driving $\pm 2.5V$ signals into 50Ω or 75Ω loads. These devices are current-mode feedback amplifiers; gain is set by external feedback resistors. The MAX4158/MAX4159 are optimized for unity gain (0dB) with a -3dB bandwidth of 350MHz. The MAX4258/MAX4259 are optimized for gains of two (6dB) or more with a 250MHz -3dB bandwidth. These devices have low (0.01%/0.01°) differential gain and phase errors, and operate from $\pm 5V$ supplies.

These devices are ideal for use in broadcast and graphics video systems because of their low, 2pF input capacitance, channel-to-channel switching time of only 20ns, and wide, 130MHz 0.1dB bandwidth. In addition, the combination of ultra-high speed and low power makes them suitable for use in general-purpose high-speed applications, such as medical imaging, industrial instrumentation, and communications systems.

The MAX4159/MAX4259 have address latching and high-impedance output disabling, allowing them to be incorporated into large switching arrays. They are available in 14-pin SO and 16-pin QSOP packages. The MAX4158/MAX4258 have no address latching or output disabling, but are available in space-saving 8-pin μ MAX and SO packages.

Applications

Video-Signal Multiplexing
Video Crosspoint Switches
Pixel Switching
Coaxial Cable Drivers
Workstations
High-Definition TV (HDTV)
Broadcast Video
Multimedia Products
High-Speed Signal Processing

- ◆ **Excellent Video Specifications:**
 - 0.1dB Gain Flatness to 130MHz
 - 0.01%/0.01° Differential Gain/Phase Error
- ◆ **High Speed:**
 - 350MHz -3dB Bandwidth (MAX4158/4159)
 - 250MHz -3dB Bandwidth (MAX4258/4259)
 - 700V/ μ s Slew Rate (MAX4158/4159)
 - 1000V/ μ s Slew Rate (MAX4258/4259)
 - 20ns Settling Time to 0.1%
- ◆ **Fast Switching:**
 - 20ns Channel-Switching Time
 - <70mV Switching Transient
- ◆ **Low Power: 100mW**
- ◆ **Directly Drive 75Ω or 50Ω Cables**
- ◆ **High Output Current Drive: >70mA**
- ◆ **Address Latch and High-Z Output Disable**

Ordering Information

PART	TEMP. RANGE	PIN-PACKAGE
MAX4158ESA	-40°C to +85°C	8 SO
MAX4158EUA	-40°C to +85°C	8 μ MAX
MAX4159ESD	-40°C to +85°C	14 SO
MAX4159EEE	-40°C to +85°C	16 QSOP
MAX4258ESA	-40°C to +85°C	8 SO
MAX4258EUA	-40°C to +85°C	8 μ MAX
MAX4259ESD	-40°C to +85°C	14 SO
MAX4259EEE	-40°C to +85°C	16 QSOP

Pin Configurations

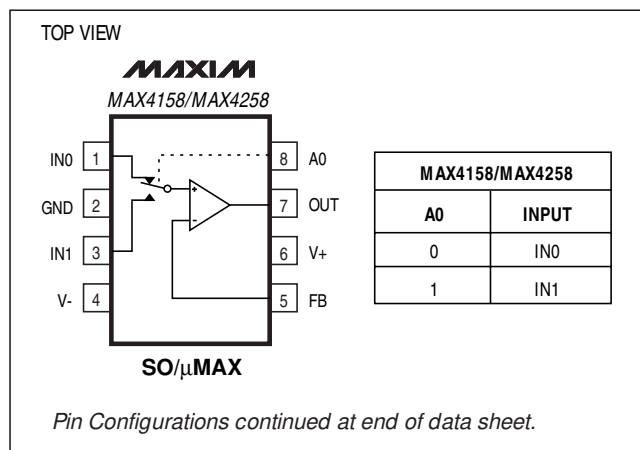

MAX4158/MAX4159/MAX4258/MAX4259

350MHz/250MHz, 2-Channel Video Multiplexer-Amplifiers

ABSOLUTE MAXIMUM RATINGS

Positive Supply Voltage (V+ to GND)+6V
Negative Supply Voltage (V- to GND)-6V
Amplifier Input Voltage (IN0 or IN1)(V- - 0.3V) to (V+ + 0.3V)
FB Current±20mA
Digital Input Voltage (A0, \overline{EN} , or LE)-0.3V to (V+ + 0.3V)
Output Short Circuit to GND (Note 1)Continuous
Output Short-Circuit Current to V+, V- (Note 1)5s

Continuous Power Dissipation (TA = +70°C)	
8-Pin SO (derate 5.88mW/°C above +70°C)471mW
8-Pin μ MAX (derate 4.10mW/°C above +70°C)330mW
14-Pin SO (derate 8.33mW/°C above +70°C)667mW
16-Pin QSOP (derate 8.33mW/°C above +70°C)667mW
Operating Temperature Range-40°C to +85°C
Storage Temperature Range-65°C to +160°C
Lead Temperature (soldering, 10s)+300°C

Note 1: Continuous power dissipation maximum rating must also be observed.

Stresses beyond those listed under "Absolute Maximum Ratings" may cause permanent damage to the device. These are stress ratings only, and functional operation of the device at these or any other conditions beyond those indicated in the operational sections of the specifications is not implied. Exposure to absolute maximum rating conditions for extended periods may affect device reliability.

DC ELECTRICAL CHARACTERISTICS

(V+ = +5V, V- = -5V, VIN = 0V, VOUT = 0V, RL = ∞, TA = TMIN to TMAX, unless otherwise noted. Typical values are at TA = +25°C.)

PARAMETER	SYMBOL	CONDITIONS	MIN	TYP	MAX	UNITS
Operating Supply-Voltage Range	V+, V-	Inferred from the PSRR test	±4.5		±5.5	V
Input Voltage Range	VIN	Inferred from the CMRR test	±2.5	±3.0		V
Input Offset Voltage (Either Channel)	VOS			±1	±6	mV
Input Offset Voltage Temperature Coefficient (Either Channel)	TCVOS			2		μ V/°C
Input Bias Current (Channel On)	IIN	TA = +25°C		±2	±10	μ A
		TA = TMIN to TMAX			±18	
FB Pin Bias Current	IFB	TA = +25°C		±2	±12	μ A
		TA = TMIN to TMAX			±20	
Input Resistance	RIN	VIN = -2.5V to 2.5V	Channel on	100	550	k Ω
			Channel off	1	20	M Ω
FB Pin Input Resistance	RIN(FB)			50		Ω
Output Resistance	ROUT	f = 0Hz		40		m Ω
Disabled Output Resistance	ROUT(d)	MAX4159/MAX4259 only, \overline{EN} = 5V, VOUT = -3.0V to 3.0V (Note 2)	1	10		M Ω
Open-Loop Transimpedance	ZT	VOUT = -2.5V to 2.5V, RL = 100 Ω	1.0	3.0		M Ω
DC Common-Mode Rejection Ratio	CMRR	VIN = -2.5V to 2.5V	50	60		dB
DC Power-Supply Rejection Ratio	PSRR	Open loop, V+ = +4.5V to +5.5V, V- = -4.5V to -5.5V	60	78		dB
Output Voltage Swing	VOUT	RL = open circuit	±3.0	±4.0		V
		RL = 50 Ω	±2.5	±3.5		
Output Current	IOUT	VOUT = -2.5V to 2.5V	70	100		mA
Output Short-Circuit Current	ISC	Sinking or sourcing to ground		120		mA
Positive Supply Current	I+	MAX4158/MAX4258		10.9	13.0	mA
		\overline{EN} = GND, MAX4159/MAX4259		10.9	13.0	
		\overline{EN} = V+, MAX4159/MAX4259		6.3	8.0	
Negative Supply Current	I-	MAX4158/MAX4258		9.9	12.0	mA
		\overline{EN} = GND, MAX4159/MAX4259		9.9	12.0	
		\overline{EN} = V+, MAX4159/MAX4259		5.0	7.0	

350MHz/250MHz, 2-Channel Video Multiplexer-Amplifiers

MAX4158/MAX4159/MAX4258/MAX4259

DC ELECTRICAL CHARACTERISTICS (continued)

(V₊ = +5V, V₋ = -5V, V_{IN} = 0V, V_{OUT} = 0V, R_L = ∞, T_A = T_{MIN} to T_{MAX}, unless otherwise noted. Typical values are at T_A = +25°C.)

PARAMETER	SYMBOL	CONDITIONS	MIN	TYP	MAX	UNITS
LOGIC CHARACTERISTICS (Note 3)						
Logic-Low Threshold	V _{IL}				0.8	V
Logic-High Threshold	V _{IH}		2.0			V
Logic-Low Input Current	I _{IL}	V _{IL} = 0		-2	-20	μA
Logic-High Input Current	I _{IH}	V _{IH} = 5.5V, V ₊ = +5.5V		130	300	μA

AC ELECTRICAL CHARACTERISTICS—MAX4158/MAX4159

(V₊ = +5V, V₋ = -5V, V_{IN} = 0V, V_{OUT} = 0V, R_L = 100Ω, T_A = +25°C, unless otherwise noted.)

PARAMETER	SYMBOL	CONDITIONS	MIN	TYP	MAX	UNITS
AMPLIFIER CHARACTERISTICS						
-3dB Bandwidth	BW	A _V = 0dB, V _{IN} = 20mVp-p (Note 4)		350		MHz
Bandwidth for ±0.1dB Gain Flatness	BW(0.1)	A _V = 0dB, V _{IN} = 20mVp-p (Note 4)		100		MHz
Full-Power Bandwidth	FPBW	A _V = 0dB, V _{OUT} = 2Vp-p (Note 4)		155		MHz
Slew Rate	SR	A _V = 0dB, V _{OUT} = 2Vp-p (Note 4)		700		V/μs
Settling Time to 0.1%	t _S	V _{OUT} = 2V step, A _V = 0dB (Note 4)		10		ns
Differential Gain Error	DG	A _V = 0dB (Notes 4, 5)		0.01		%
Differential Phase Error	DP	A _V = 0dB (Notes 4, 5)		0.01		degrees
Channel-to-Channel Crosstalk	Xtalk	f = 30MHz, R _S = 50Ω, A _V = 0dB, V _{IN} = ±2Vp-p (Note 4)		70		dB
Output Impedance	Z _{OUT}	f = 30MHz, A _V = 0dB (Note 4)		9		Ω
Total Harmonic Distortion	THD	f = 30MHz, V _{OUT} = 2Vp-p, A _V = 0dB (Note 4)		50		dBc
Off-Isolation (MAX4159 only)	A _{ISO}	f = 30MHz, A _V = 0dB, \overline{EN} = 5V, V _{IN} = ±2Vp-p (Note 4)		105		dB
Output Capacitance	C _{OUT}			3		pF
Input Capacitance	C _{IN}	Channel on or off		2		pF
Input Voltage-Noise Density	e _n	f = 100kHz		2		nV/√Hz
Input Current-Noise Density	i _n	f = 100kHz		2		pA/√Hz
FB Current-Noise Density	i _n (FB)	f = 100kHz		22		pA/√Hz
SWITCHING CHARACTERISTICS						
Channel Switching Time	t _{SW}	(Notes 6, 7)		20		ns
Address Setup Time	t _S	T _A = T _{MIN} to T _{MAX} (Notes 6, 8)	10			ns
Address Hold Time	t _{TH}	T _A = T _{MIN} to T _{MAX} (Notes 6, 8)	10			ns
Latch Propagation Delay	t _{LPD}	(Note 6)		20		ns
Latch Pulse Width	t _{LPW}	T _A = T _{MIN} to T _{MAX} (Notes 6, 8)	10			ns
Enable Delay Time	t _{PDE}	(Notes 6, 9)		20		ns
Disable Delay Time	t _{PDD}	(Notes 6, 9)		20		ns
Switching Transient	V _{TRAN}	A _V = 0dB (Notes 4, 10)		±70		mV

350MHz/250MHz, 2-Channel Video Multiplexer-Amplifiers

AC ELECTRICAL CHARACTERISTICS—MAX4258/MAX4259

($V_+ = +5V$, $V_- = -5V$, $V_{IN} = 0V$, $V_{OUT} = 0V$, $R_L = 100\Omega$, $T_A = +25^\circ C$, unless otherwise noted.)

PARAMETER	SYMBOL	CONDITIONS	MIN	TYP	MAX	UNITS
AMPLIFIER CHARACTERISTICS						
-3dB Bandwidth	BW	$A_V = 6dB$, $V_{IN} = 20mVp-p$ (Note 4)		250		MHz
Bandwidth for $\pm 0.1dB$ Gain Flatness	BW(0.1)	$A_V = 6dB$, $V_{IN} = 20mVp-p$ (Note 4)		130		MHz
Full-Power Bandwidth	FPBW	$A_V = 6dB$, $V_{OUT} = 2Vp-p$ (Note 4)		200		MHz
Slew Rate	SR	$A_V = 6dB$, $V_{OUT} = 2Vp-p$ (Note 4)		1000		V/ μs
Settling Time to 0.1%	t_S	$V_{OUT} = 2V$ step, $A_V = 6dB$ (Note 4)		10		ns
Differential Gain Error	DG	$A_V = 6dB$ (Notes 4, 5)		0.01		%
Differential Phase Error	DP	$A_V = 6dB$ (Notes 4, 5)		0.02		degrees
Channel-to-Channel Crosstalk	Xtalk	$f = 30MHz$, $R_S = 50\Omega$, $A_V = 6dB$, $V_{IN} = \pm 1Vp-p$ (Note 4)		70		dB
Output Impedance	Z_{OUT}	$f = 30MHz$, $A_V = 6dB$ (Note 4)		9		Ω
Total Harmonic Distortion	THD	$f = 30MHz$, $V_{OUT} = 2Vp-p$, $A_V = 6dB$ (Note 4)		50		dBc
Off-Isolation (MAX4259)	A_{ISO}	$f = 30MHz$, $A_V = 6dB$, $\overline{EN} = 5V$, $V_{IN} = \pm 1Vp-p$ (Note 4)		110		dB
Output Capacitance	C_{OUT}			3		pF
Input Capacitance	C_{IN}	Channel on or off		2		pF
Input Voltage-Noise Density	e_n	$f = 100kHz$		2		nV/\sqrt{Hz}
Input Current-Noise Density	i_n	$f = 100kHz$		2		pA/\sqrt{Hz}
FB Current-Noise Density	$i_n(FB)$	$f = 100kHz$		22		pA/\sqrt{Hz}
SWITCHING CHARACTERISTICS						
Channel-Switching Time	t_{SW}	(Notes 6, 7)		20		ns
Address-Setup Time	t_S	$T_A = T_{MIN}$ to T_{MAX} (Notes 6, 8)	10			ns
Address-Hold Time	t_{TH}	$T_A = T_{MIN}$ to T_{MAX} (Notes 6, 8)	10			ns
Latch Propagation Delay	t_{LPD}	(Note 6)		20		ns
Latch Pulse Width	t_{LPW}	$T_A = T_{MIN}$ to T_{MAX} (Notes 6, 8)	10			ns
Enable Delay Time	t_{PDE}	(Notes 6, 9)		20		ns
Disable Delay Time	t_{PDD}	(Notes 6, 9)		20		ns
Switching Transient	V_{TRAN}	$A_V = 6dB$ (Notes 4, 10)		± 90		mV

Note 2: Does not include external feedback network resistance.

Note 3: Applies to all digital input pins (\overline{EN} , LE, and A0).

Note 4: Specified with feedback network chosen for optimal AC performance. See Tables 1 and 2 for recommended component values.

Note 5: Input test signal: 3.58MHz sine wave of amplitude 40IRE superimposed on a linear ramp (0IRE to 100IRE). IRE is a unit of video-signal amplitude developed by the International Radio Engineers. 140IRE = 1.0V.

Note 6: See timing diagram (Figure 5).

Note 7: Channel-switching time specified for switching between the two input channels; does not include signal rise/fall times for switching between channels with different input voltages.

Note 8: Guaranteed by design; not production tested.

Note 9: Output enable/disable delay times do not include amplifier output slewing times.

Note 10: Switching transient measured while switching between two grounded channels.

350MHz/250MHz, 2-Channel Video Multiplexer-Amplifiers

Typical Operating Characteristics

($V_+ = +5V$, $V_- = -5V$, $T_A = +25^\circ C$, unless otherwise noted.)

MAX4158/MAX4159/MAX4258/MAX4259

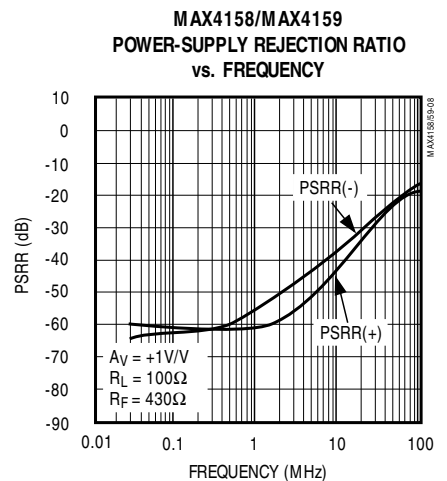
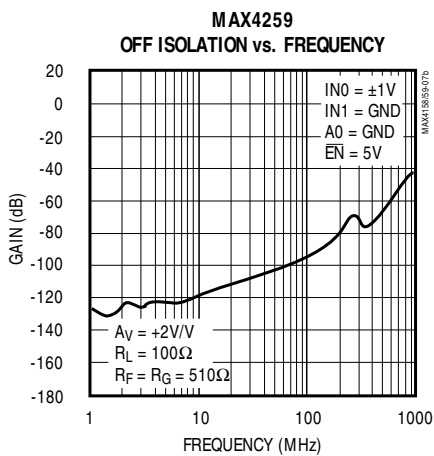
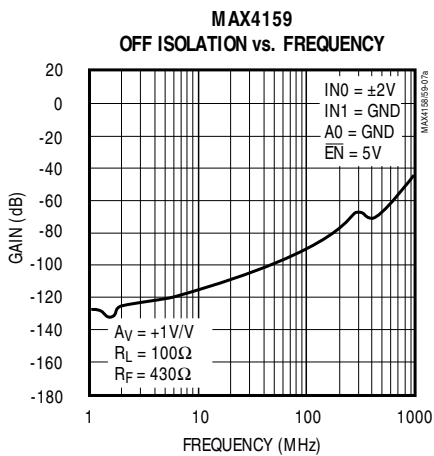
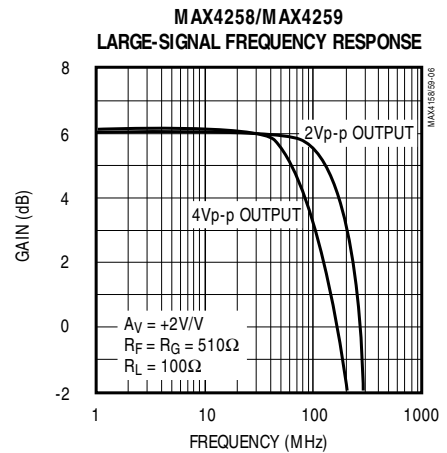
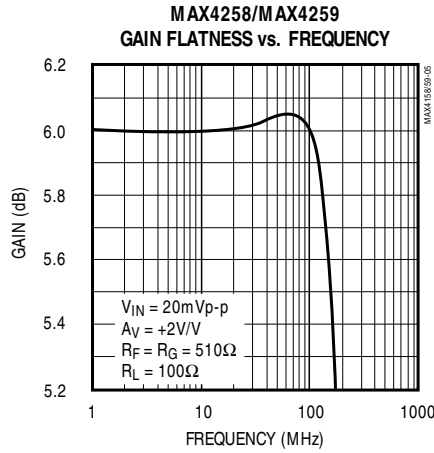
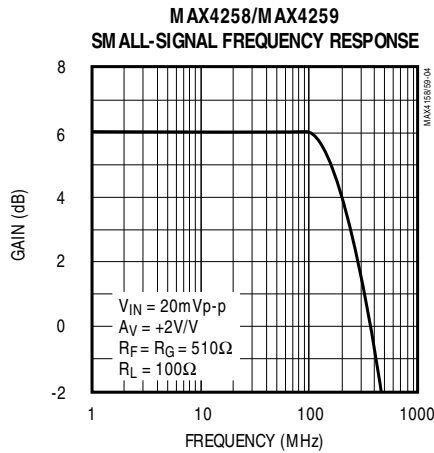
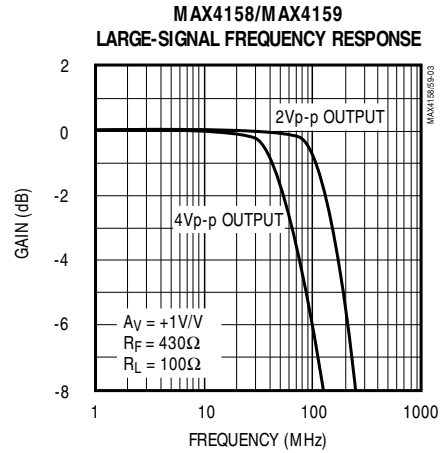
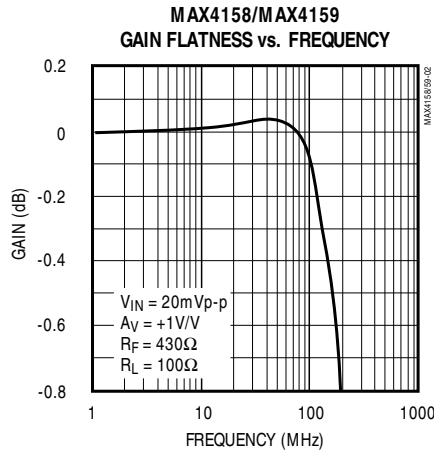
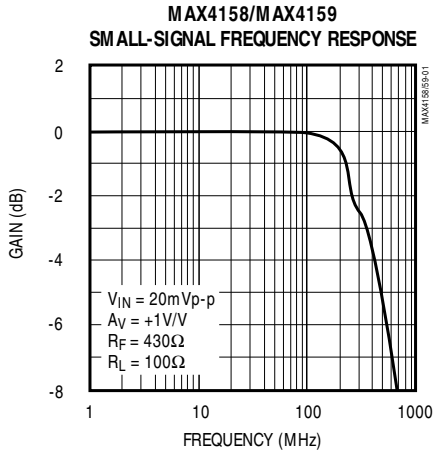

350MHz/250MHz, 2-Channel Video Multiplexer-Amplifiers

Typical Operating Characteristics (continued)

($V_+ = +5V$, $V_- = -5V$, $T_A = +25^\circ C$, unless otherwise noted.)

MAX4258/MAX4259
POWER-SUPPLY REJECTION RATIO
vs. FREQUENCY

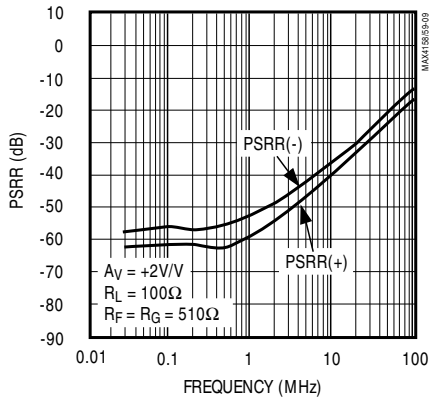

CROSSTALK vs. FREQUENCY

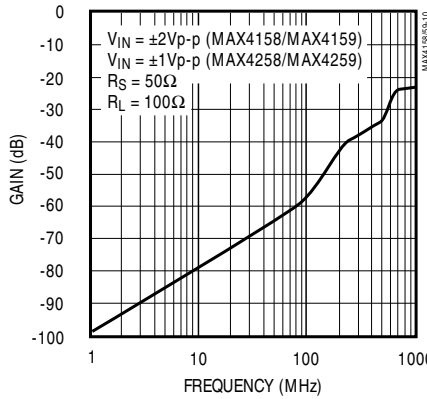

OUTPUT IMPEDANCE vs. FREQUENCY

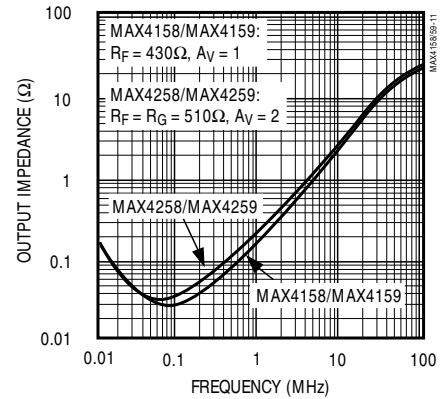

MAX4158/MAX4159
CHANNEL-TO-CHANNEL GAIN MATCHING
vs. FREQUENCY

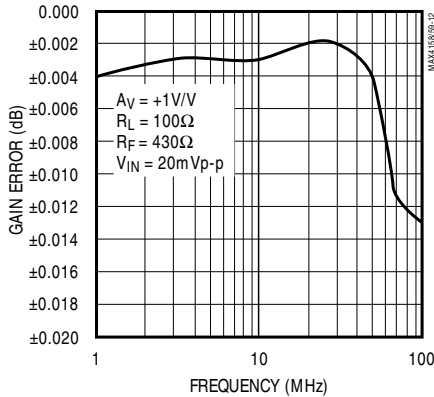

MAX4258/MAX4259
CHANNEL-TO-CHANNEL GAIN MATCHING
vs. FREQUENCY

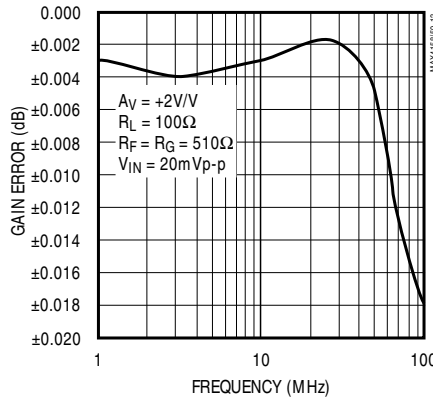

MAX4158/MAX4159
TOTAL HARMONIC DISTORTION
vs. FREQUENCY

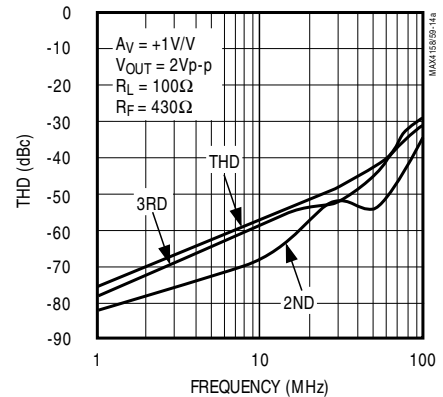

MAX4258/MAX4259
TOTAL HARMONIC DISTORTION
vs. FREQUENCY

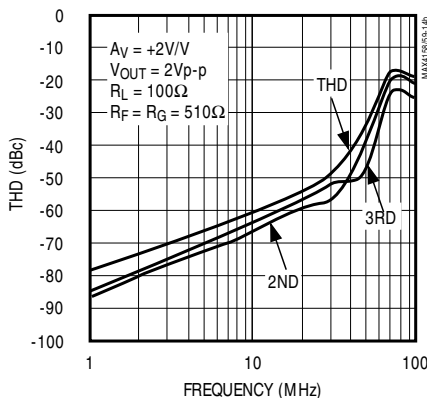

MAX4158/MAX4159
LARGE-SIGNAL PULSE RESPONSE

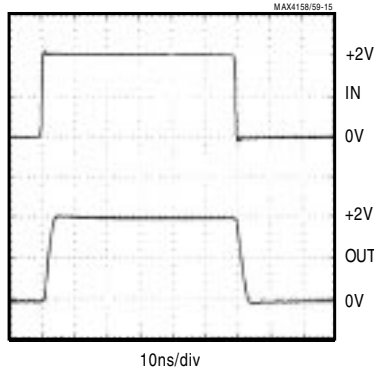

MAX4258/MAX4259
LARGE-SIGNAL PULSE RESPONSE

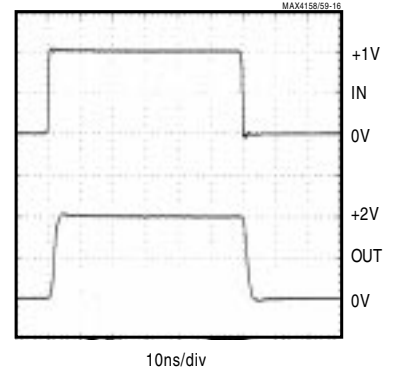

350MHz/250MHz, 2-Channel Video Multiplexer-Amplifiers

Typical Operating Characteristics (continued)

(V+ = +5V, V- = -5V, T_A = +25°C, unless otherwise noted.)

MAX4158/MAX4159/MAX4258/MAX4259

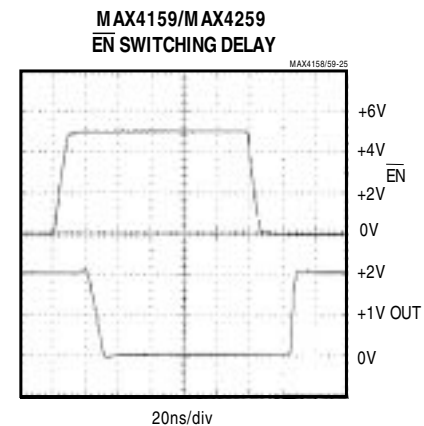
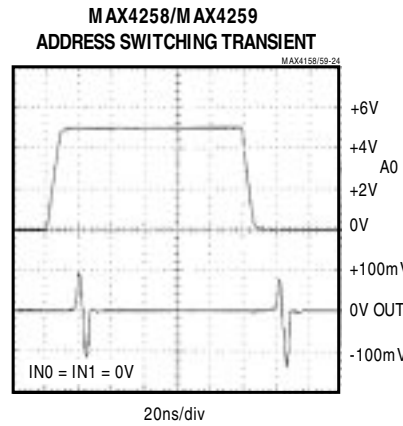
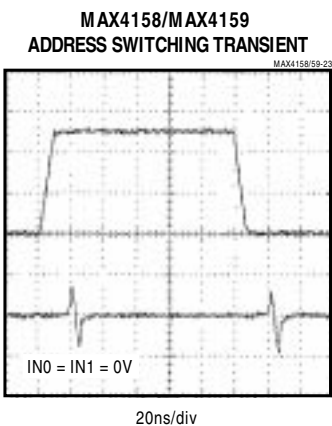
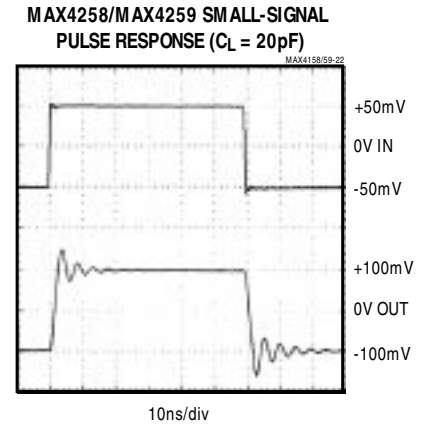
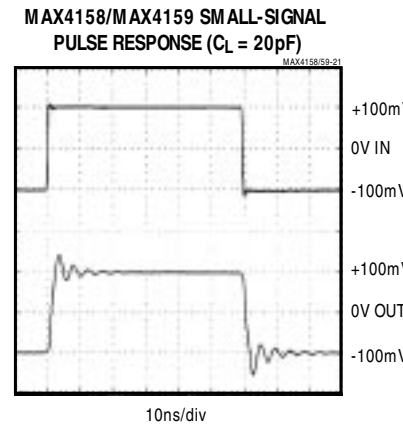
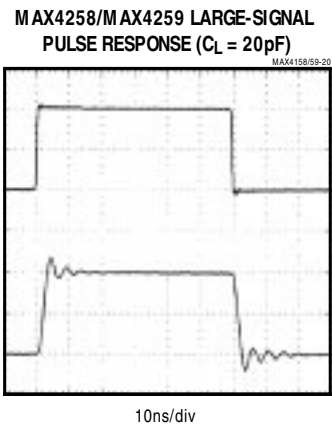
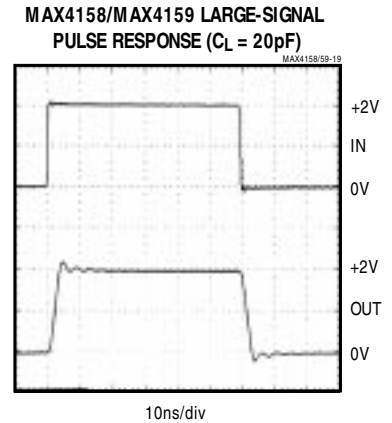
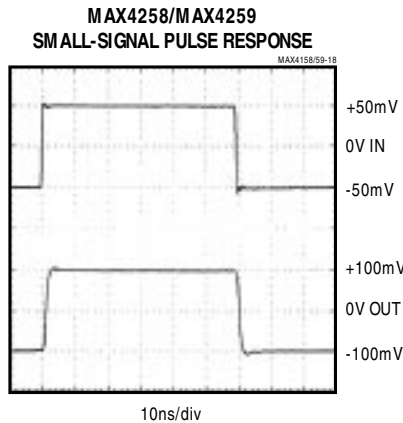
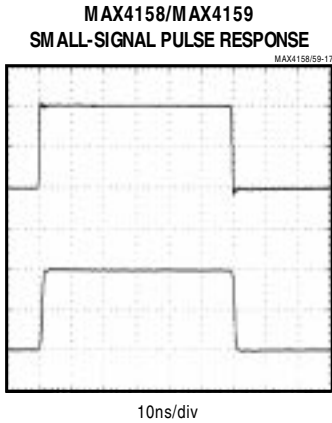

350MHz/250MHz, 2-Channel Video Multiplexer-Amplifiers

Typical Operating Characteristics (continued)

(V+ = +5V, V- = -5V, T_A = +25°C, unless otherwise noted.)

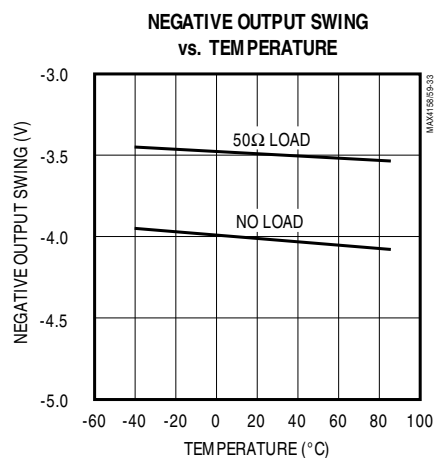
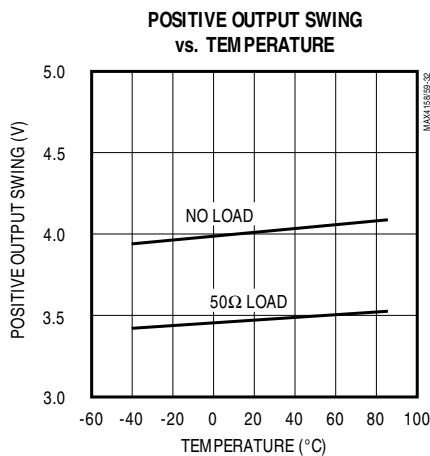
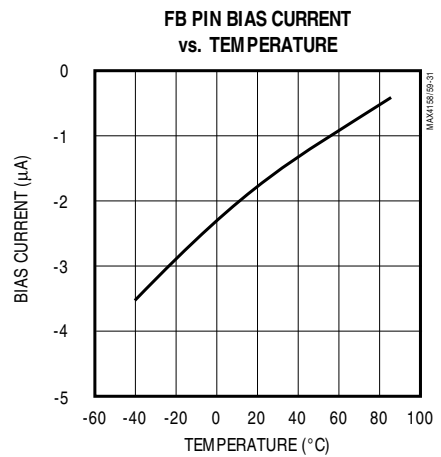
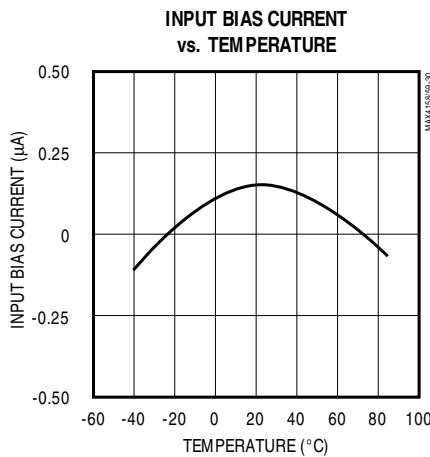
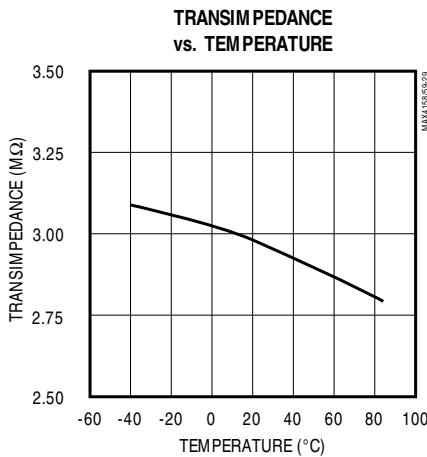
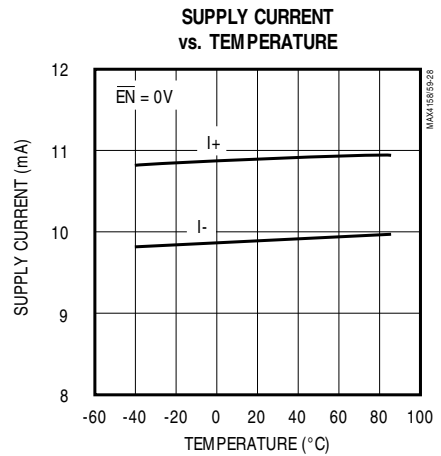
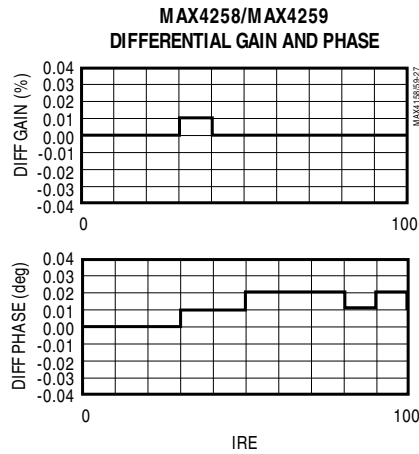
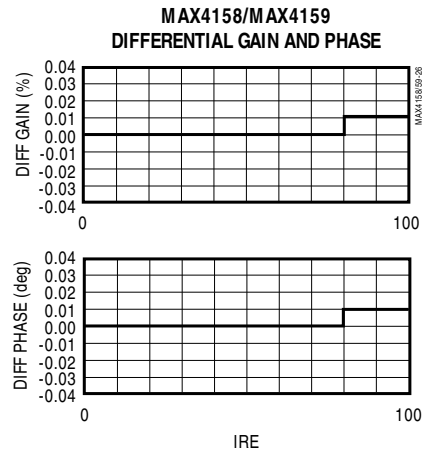

350MHz/250MHz, 2-Channel Video Multiplexer-Amplifiers

Typical Operating Characteristics (continued)

(V+ = +5V, V- = -5V, T_A = +25°C, unless otherwise noted.)

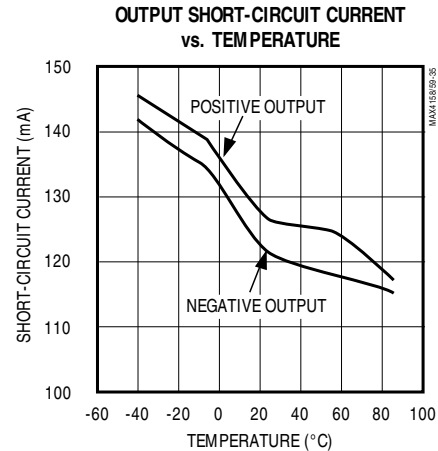
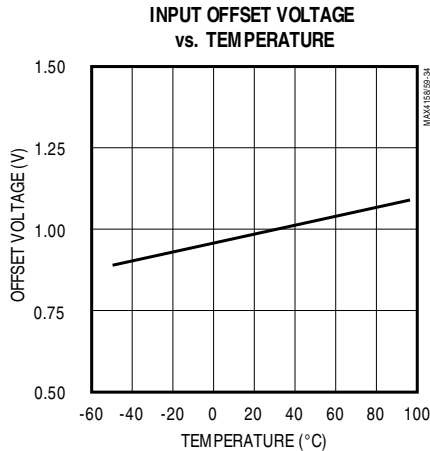

Pin Description

MAX4158 MAX4258	PIN		NAME	FUNCTION
	SO	QSOP		
—	1	1	\overline{EN}	Output Enable Logic Input. Connect \overline{EN} to logic low or leave open for normal operation. Connect to logic high to disconnect amplifier output (output is high impedance).
1	3	3	IN0	Amplifier Input, Channel 0
2	2, 4, 6, 8, 10	2, 4, 6, 9, 11	GND	Power Supply, Analog and Digital Ground. Connect GND to ground plane for best RF performance.
3	5	5	IN1	Amplifier Input, Channel 1
—	—	7, 15	N.C.	No Connection. Not internally connected. Connect to ground plane for best RF performance.
4	7	8	V-	Negative Power-Supply Voltage
5	9	10	FB	Amplifier Feedback Input
6	11	12	V+	Positive Power-Supply Voltage
7	12	13	OUT	Amplifier Output
8	13	14	A0	Channel-Address Logic Input (see <i>Truth Table</i>)
—	14	16	LE	Latch-Enable Logic Input (see <i>Truth Table</i>)

350MHz/250MHz, 2-Channel Video Multiplexer-Amplifiers

Detailed Description

The MAX4158/MAX4159 are optimized for closed-loop gains (A_{VCL}) of 1V/V (0dB) or greater; the MAX4258/MAX4259 are optimized for closed-loop gains of 2V/V (6dB) or greater. These low-power, high-speed, current-mode feedback amplifiers operate from $\pm 5V$ supplies. They drive video loads (including 50 Ω and 75 Ω cables) with excellent distortion characteristics. Differential gain and phase errors are 0.01%/0.01° for MAX4158/MAX4159 and 0.01%/0.02° for MAX4258/MAX4259, respectively.

The input multiplexers feature very short switching times and small switching transients. They also have high input resistance and constant input capacitance, so overall input impedance can be set by external input terminating resistors. Each video input is isolated by an AC-ground pin, which reduces channel-to-channel capacitance and minimizes crosstalk.

The MAX4159/MAX4259 have address latching and an output enable function that places the output in a high-impedance state. These functions allow multiple mux/amps to be paralleled together to form larger switching arrays.

Truth Tables

Input Control Logic

LOGIC INPUTS		AMPLIFIER INPUT	FUNCTION
LE	A0		
0	0	IN0	Channel 0 selected
0	1	IN1	Channel 1 selected
1	X	[LAST]	Channel addresses latched; retains last input address.

X = Don't Care

MAX4159/MAX4259 Output Control Logic

LOGIC INPUT (\overline{EN})	AMPLIFIER OUTPUT	FUNCTION
0	On	Output on
1	Off	Output off; high impedance

All logic levels (\overline{EN} , LE, and A0) default low (0) if left open circuit. Output disable is completely independent of input address and latch.

Applications Information

Theory of Operation

Since the MAX4158/MAX4159/MAX4258/MAX4259 are current-mode feedback amplifiers, their open-loop transfer function is expressed as a transimpedance, $\Delta V_{OUT}/\Delta I_{FB}$, or Z_T . The frequency behavior of this open-loop transimpedance is similar to the open-loop gain of a voltage-mode feedback amplifier. That is, it has a large DC value and decreases at approximately 6dB per octave at high frequency.

Analyzing the current-mode feedback amplifier in a gain configuration (Figure 1) yields the following transfer function:

$$V_{OUT} / V_{IN} = G \times Z_T(S) / (Z_T(S) + G \times R_{IN(FB)} + R_F)$$

where $G = A_{VCL} = 1 + R_F / R_G$.

At low gains, $G \times R_{IN(FB)} \ll R_F$. Therefore, unlike traditional voltage-mode feedback amplifiers, the closed-loop bandwidth is essentially independent of closed-loop gain. Note also that at low frequencies, $Z_T \gg [G \times R_{IN(FB)} + R_F]$ so:

$$V_{OUT} / V_{IN} = G = 1 + R_F / R_G$$

Layout and Power-Supply Bypassing

The MAX4158/MAX4159/MAX4258/MAX4259 have extremely high bandwidth, and consequently require careful board layout, including the possible use of constant-impedance microstrip or stripline techniques.

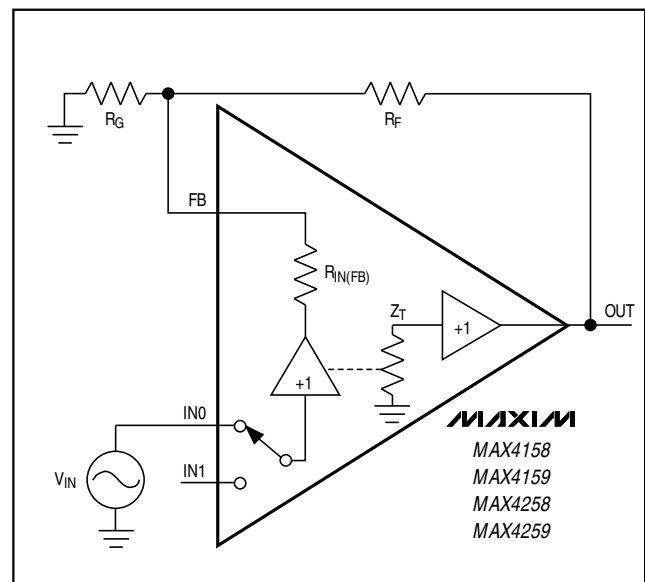

Figure 1. Current-Mode Feedback Amplifier

350MHz/250MHz, 2-Channel Video Multiplexer-Amplifiers

MAX4158/MAX4159/MAX4258/MAX4259

Choosing Feedback and Gain Resistors

To realize the full AC performance of these high-speed amplifiers, pay careful attention to power-supply bypassing and board layout. The PC board should have at least two layers: a signal and power layer on one side, and a large, low-impedance ground plane on the other side. The ground plane should be as free of voids as possible, with one exception: the feedback pin (FB) should have as low a capacitance to ground as possible. This means that there should be no ground plane under FB or under the components (R_F and R_G) connected to it. With multilayer boards, locate the ground plane on a layer that incorporates no signal or power traces.

Regardless of whether or not a constant-impedance board is used, it is best to observe the following guidelines when designing the board:

- 1) Do not use wire-wrap boards (they are much too inductive) or breadboards (they are much too capacitive).
- 2) Do not use IC sockets. IC sockets increase reactances.
- 3) Keep lines as short and as straight as possible. Do not make 90° turns; round all corners.
- 4) Observe high-frequency bypassing techniques to maintain the amplifier's accuracy and stability.
- 5) Bear in mind that, in general, surface-mount components have shorter bodies and lower parasitic reactance, giving much better high-frequency performance than through-hole components.

The bypass capacitors should include a 10nF ceramic surface-mount capacitor between each supply pin and the ground plane, located as close to the package as possible. Optionally, place a 10 μ F tantalum capacitor at the power-supply pins' points of entry to the PC board to ensure the integrity of incoming supplies. The power-supply trace should lead directly from the tantalum capacitor to the V+ and V- pins. To minimize parasitic inductance, keep PC traces short and use surface-mount components.

Ground pins have been placed between input channels to minimize crosstalk between the two input channels. (The grounds extend inside the package all the way to the silicon.) These pins should be connected to a common ground plane on the PC board.

Input termination resistors and output back-termination resistors, if used, should be surface-mount types, and should be placed as close to the IC pins as possible.

As with all current-mode feedback amplifiers, the frequency response of the MAX4158/MAX4159/MAX4258/MAX4259 is critically dependent on the value of the feedback resistor R_F . R_F , in conjunction with an internal compensation capacitor, forms the dominant pole in the feedback loop. Reducing R_F 's value increases the pole frequency and the -3dB bandwidth, but also increases peaking due to interaction with other nondominant poles. Increasing R_F 's value reduces peaking and bandwidth.

Tables 1 and 2 show optimal values for the feedback resistor (R_F) and gain-setting resistor (R_G) for all parts. Note that the MAX4258/MAX4259 offer superior AC performance for all gains except unity gain (0dB). These values provide optimal AC response using surface-mount resistors and good layout techniques. The MAX4159/MAX4259 evaluation kit provides a practical example of such layout techniques.

Stray capacitance at FB causes feedback resistor decoupling and produces peaking in the frequency-response curve. Keep the capacitance at FB as low as possible by using surface-mount resistors, and avoiding the use of a ground plane beneath or beside these resistors and the FB pin. Some capacitance is unavoidable; if necessary, its effects can be counteracted by adjusting R_F . 1% resistors are recommended to maintain consistency over a wide range of production lots.

Table 1. MAX4158/MAX4159 Bandwidth and Gain vs. Gain-Setting Resistors

GAIN		R_G (Ω)	R_F (Ω)	-3dB BW (MHz)	0.1dB BW (MHz)
(V/V)	(dB)				
1	0	∞	430	350	100
2	6	110	110	200	110
5	14	32.5	130	80	12
10	20	14.5	130	40	6

350MHz/250MHz, 2-Channel Video Multiplexer-Amplifiers

Table 2. MAX4258/MAX4259 Bandwidth and Gain vs. Gain-Setting Resistors

GAIN		R _G (Ω)	R _F (Ω)	-3dB BW (MHz)	0.1dB BW (MHz)
(V/V)	(dB)				
2	6	510	510	250	130
5	14	45	180	195	92
10	20	20	180	90	14

DC Errors and Noise

The MAX4158/MAX4159/MAX4258/MAX4259 output offset voltage, V_{OUT} (Figure 2) can be calculated with the following equation:

$$V_{OUT} = V_{OS} \times [1 + R_F / R_G] + I_B \times R_S \times [1 + R_F / R_G] + I_{FB} \times R_F$$

where:

- V_{OS} = input offset voltage (in volts)
- 1 + R_F / R_G = amplifier closed-loop gain (dimensionless)
- I_B = input bias current (in amps)
- I_{FB} = feedback input bias current (in amps)
- R_G = gain-setting resistor (in ohms)
- R_F = feedback resistor (in ohms)
- R_S = source resistor (in ohms)

The following equation represents output noise density:

$$e_n(OUT) = (1 + R_F / R_G) \times \sqrt{[i_n \times R_S]^2 + [i_n(FB) \times (R_F \parallel R_G)]^2 + [e_n]^2}$$

where:

- i_n = input noise current density (in A/√Hz)
- e_n = input noise voltage density (in V/√Hz)

The MAX4158/MAX4159/MAX4258/MAX4259 have a very low, 2nV/√Hz noise voltage. The current noise at the input (i_n) is 2pA/√Hz, and the current noise at the feedback input (i_{n(FB)}) is 22pA/√Hz.

An example of DC-error calculations, using the MAX4258 typical data and the typical operating circuit with R_F = R_G = 510Ω (R_F ∥ R_G = 255Ω) and R_S = 50Ω, gives:

$$V_{OUT} = [1 \times 10^{-3} \times (1 + 1)] + [2 \times 10^{-6} \times 50 \times (1 + 1)] + [2 \times 10^{-6} \times 510]$$

$$V_{OUT} = 3.22mV$$

Calculating total output noise in a similar manner yields the following:

$$e_n(OUT) = (1 + 1) \times \sqrt{[(2 \times 10^{-12}) \times 50]^2 + [(22 \times 10^{-12}) \times 255]^2 + (2 \times 10^{-9})^2}$$

$$e_n(OUT) = 11.9nV/\sqrt{Hz}$$

With a 200MHz system bandwidth, this calculates to 168μV_{RMS} (approximately 1.01mV_{p-p}, using the six-sigma calculation).

Video Line Driver

The MAX4158/MAX4159/MAX4258/MAX4259 are optimized to drive coaxial transmission lines when the cable is terminated at both ends (Figure 3). Cable frequency response may cause variations in the flatness of the signal.

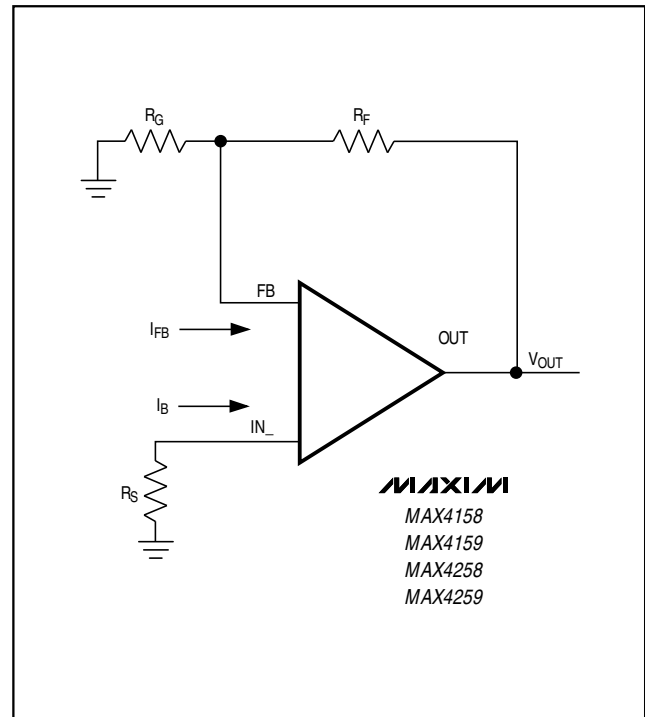

Figure 2. Output Offset Voltage

350MHz/250MHz, 2-Channel Video Multiplexer-Amplifiers

MAX4158/MAX4159/MAX4258/MAX4259

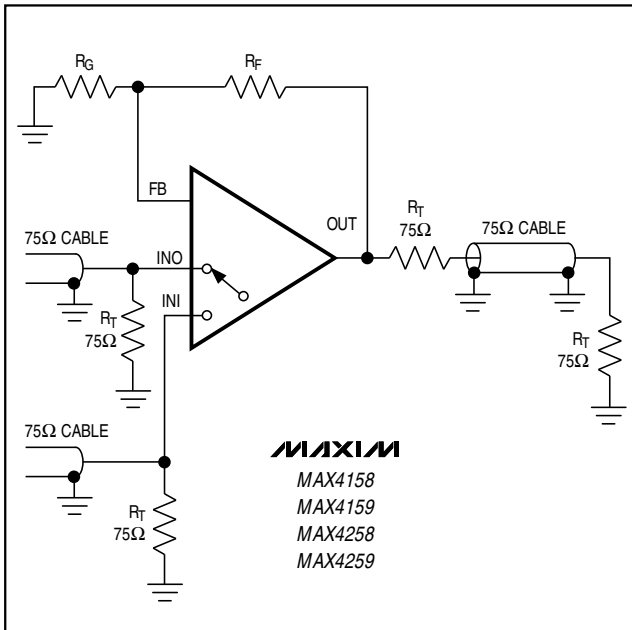

Figure 3. Video Line Driver

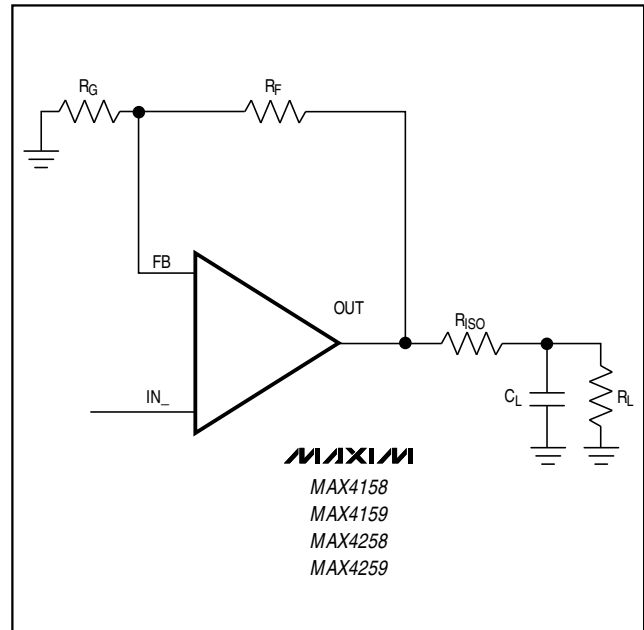

Figure 4. Using an Isolation Resistor (R_{ISO}) for High Capacitive Loads

Driving Capacitive Loads

A correctly terminated transmission line is purely resistive and presents no capacitive load to the amplifier. Consequently, the MAX4158/MAX4159/MAX4258/MAX4259 are optimized for AC performance and are not designed to drive highly capacitive loads. Reactive loads will decrease phase margin and may produce excessive ringing and oscillation (see *Typical Operating Characteristics*). The circuit of Figure 4 reduces this problem. The small (usually 5Ω to 20Ω) isolation resistor R_{ISO} , placed before the reactive load, prevents ringing and oscillation. At higher capacitive loads, AC performance is limited by the interaction of load capacitance with the isolation resistor.

350MHz/250MHz, 2-Channel Video Multiplexer-Amplifiers

Input Voltage Range

The guaranteed input voltage range is $\pm 2.5V$. Exceeding this value can cause unpredictable results, including output clipping, excessive input current, and switching delays.

Multiplexer

The input multiplexer (mux) is controlled by TTL/CMOS-compatible address inputs (see *Truth Tables*.) There is no internal memory except the address latch (LE) on

the MAX4159/MAX4259. If power is first applied with the latch enabled, IN0 is selected.

Input capacitance is a constant, low 2pF for either input channel, regardless of whether or not the channel is selected.

All logic levels (\overline{EN} , LE, and A0) default low if left open-circuit.

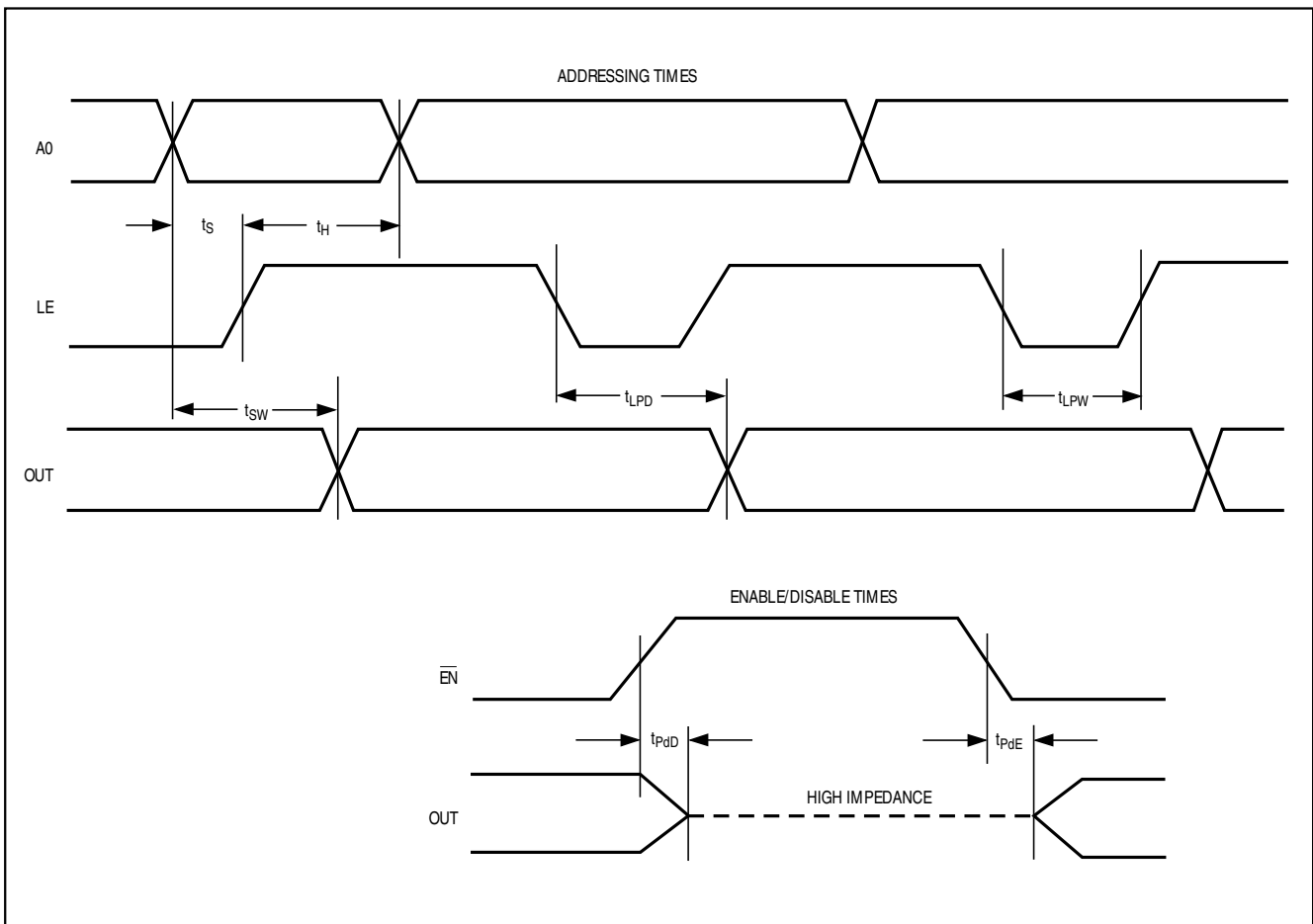
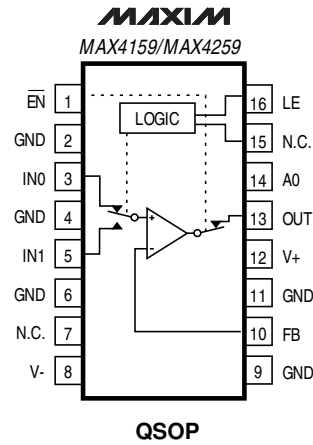
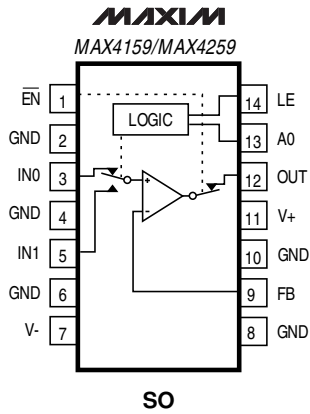

Figure 5. Switching Timing Diagram

350MHz/250MHz, 2-Channel Video Multiplexer-Amplifiers

Pin Configurations/Functional Diagrams/Truth Tables

TOP VIEW



MAX4159/MAX4259		
LE	A0	INPUT
0	0	IN0
0	1	IN1
1	X	LAST

X = DON'T CARE

MAX4159/MAX4259	
EN	OUTPUT
0	ON
1	OFF (HI-Z)

N.C. = NOT INTERNALLY CONNECTED

Chip Information

TRANSISTOR COUNT: 239

MAX4158/MAX4159/MAX4258/MAX4259

350MHz/250MHz, 2-Channel Video Multiplexer-Amplifiers

Package Information

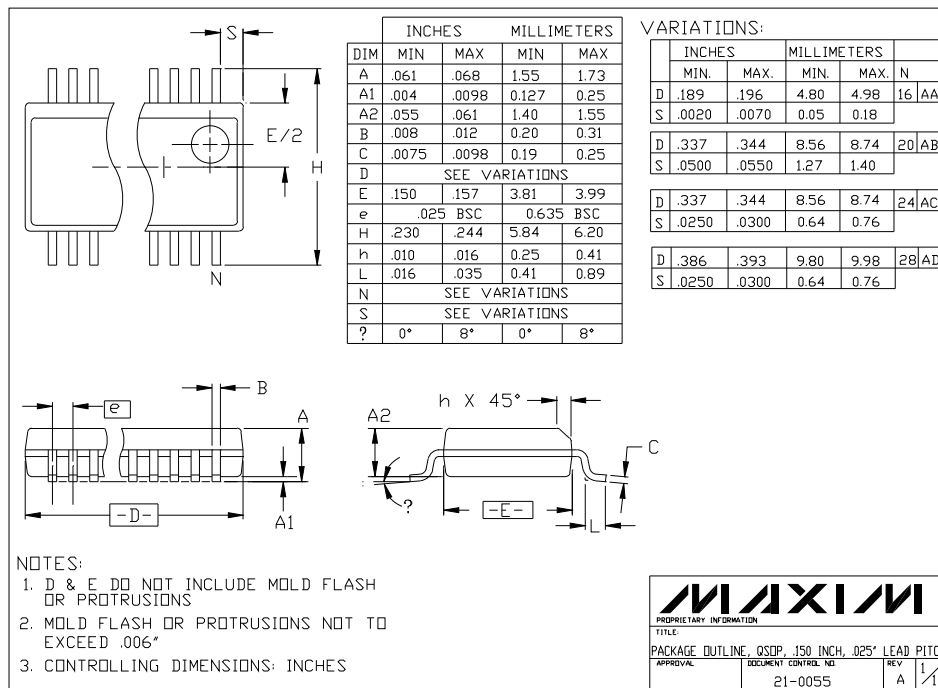
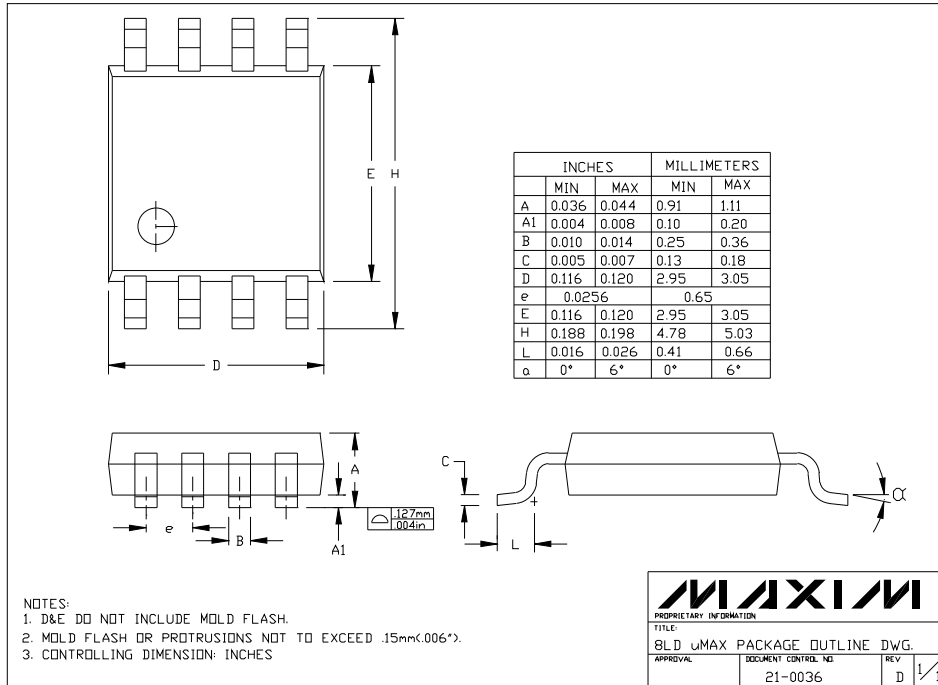

Maxim cannot assume responsibility for use of any circuitry other than circuitry entirely embodied in a Maxim product. No circuit patent licenses are implied. Maxim reserves the right to change the circuitry and specifications without notice at any time.

16 Maxim Integrated Products, 120 San Gabriel Drive, Sunnyvale, CA 94086 408-737-7600