



Chipsmall Limited consists of a professional team with an average of over 10 year of expertise in the distribution of electronic components. Based in Hongkong, we have already established firm and mutual-benefit business relationships with customers from,Europe,America and south Asia,supplying obsolete and hard-to-find components to meet their specific needs.

With the principle of “Quality Parts,Customers Priority,Honest Operation,and Considerate Service”,our business mainly focus on the distribution of electronic components. Line cards we deal with include Microchip,ALPS,ROHM,Xilinx,Pulse,ON,Everlight and Freescale. Main products comprise IC,Modules,Potentiometer,IC Socket,Relay,Connector.Our parts cover such applications as commercial,industrial, and automotives areas.

We are looking forward to setting up business relationship with you and hope to provide you with the best service and solution. Let us make a better world for our industry!



## Contact us

Tel: +86-755-8981 8866 Fax: +86-755-8427 6832

Email & Skype: info@chipsmall.com Web: www.chipsmall.com

Address: A1208, Overseas Decoration Building, #122 Zhenhua RD., Futian, Shenzhen, China





# Ultra-High-Speed, Low-Noise, Low-Power, SOT23 Open-Loop Buffers

## General Description

The MAX4200–MAX4205 are ultra-high-speed, open-loop buffers featuring high slew rate, high output current, low noise, and excellent capacitive-load-driving capability. The MAX4200/MAX4201/MAX4202 are single buffers, while the MAX4203/MAX4204/MAX4205 are dual buffers. The MAX4201/MAX4204 have integrated  $50\Omega$  termination resistors, making them ideal for driving  $50\Omega$  transmission lines. The MAX4202/MAX4205 include  $75\Omega$  back-termination resistors for driving  $75\Omega$  transmission lines. The MAX4200/MAX4203 have no internal termination resistors.

The MAX4200–MAX4205 use a proprietary architecture to achieve up to 780MHz  $-3\text{dB}$  bandwidth, 280MHz  $0.1\text{dB}$  gain flatness,  $4200\text{V}/\mu\text{s}$  slew rate, and  $\pm 90\text{mA}$  output current drive capability. They operate from  $\pm 5\text{V}$  supplies and draw only 2.2mA of quiescent current. These features, along with low-noise performance, make these buffers suitable for driving high-speed analog-to-digital converter (ADC) inputs or for data-communications applications.

## Applications

High-Speed DAC Buffers  
Wireless LANs  
Digital-Transmission Line Drivers  
High-Speed ADC Input Buffers  
IF/Communications Systems

## Selector Guide

PART	NO. OF BUFFERS	INTERNAL OUTPUT TERMINATION ( $\Omega$ )	PIN-PACKAGE
MAX4200	1	—	8 SO, 5 SOT23
MAX4201	1	50	8 SO, 5 SOT23
MAX4202	1	75	8 SO, 5 SOT23
MAX4203	2	—	8 SO/ $\mu\text{MAX}$
MAX4204	2	50	8 SO/ $\mu\text{MAX}$
MAX4205	2	75	8 SO/ $\mu\text{MAX}$

Pin Configurations appear at end of data sheet.

$\mu\text{MAX}$  is a registered trademark of Maxim Integrated Products, Inc.

## Features

- ◆ 2.2mA Supply Current
- ◆ High Speed
  - 780MHz  $-3\text{dB}$  Bandwidth (MAX4201/MAX4202)
  - 280MHz  $0.1\text{dB}$  Gain Flatness (MAX4201/MAX4202)
  - $4200\text{V}/\mu\text{s}$  Slew Rate
- ◆ Low  $2.1\text{nV}/\sqrt{\text{Hz}}$  Voltage-Noise Density
- ◆ Low  $0.8\text{pA}/\sqrt{\text{Hz}}$  Current-Noise Density
- ◆ High  $\pm 90\text{mA}$  Output Drive (MAX4200/MAX4203)
- ◆ Excellent Capacitive-Load-Driving Capability
- ◆ Available in Space-Saving SOT23 or  $\mu\text{MAX}^{\text{®}}$  Packages

## Ordering Information

PART	PIN-PACKAGE	TOP MARK	PKG CODE
MAX4200ESA	8 SO	—	S8-2
MAX4200EUK-T	5 SOT23-5	AABZ	U5-1
MAX4201ESA	8 SO	—	S8-2
MAX4201EUK-T	5 SOT23-5	ABAA	U5-1
MAX4202ESA	8 SO	—	S8-2
MAX4202EUK-T	5 SOT23-5	ABAB	U5-1
MAX4203ESA	8 SO	—	S8-2
MAX4203EUA-T	8 $\mu\text{MAX}$ -8	—	U8-1
MAX4204ESA	8 SO	—	S8-2
MAX4204EUA-T	8 $\mu\text{MAX}$ -8	—	U8-1
MAX4205ESA	8 SO	—	S8-2
MAX4205EUA-T	8 $\mu\text{MAX}$ -8	—	U8-1

**Note:** All devices are specified over the  $-40^{\circ}\text{C}$  to  $+85^{\circ}\text{C}$  operating temperature range.

## Typical Application Circuit

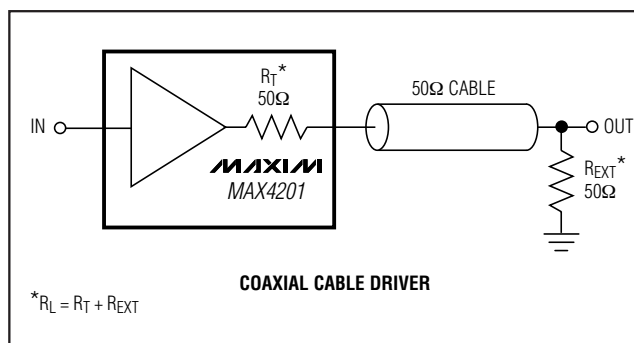

# Ultra-High-Speed, Low-Noise, Low-Power, SOT23 Open-Loop Buffers

## ABSOLUTE MAXIMUM RATINGS

Supply Voltage ( $V_{CC}$  to  $V_{EE}$ ).....+12V  
 Voltage on Any Pin to GND.....( $V_{EE} - 0.3V$ ) to ( $V_{CC} + 0.3V$ )  
 Output Short-Circuit Duration to GND.....Continuous  
 Continuous Power Dissipation ( $T_A = +70^\circ\text{C}$ )  
   5-Pin SOT23 (derate 7.1mW/ $^\circ\text{C}$  above  $+70^\circ\text{C}$ ).....571mW  
   8-Pin  $\mu\text{MAX}$  (derate 4.1mW/ $^\circ\text{C}$  above  $+70^\circ\text{C}$ ).....330mW  
   8-Pin SO (derate 5.9mW/ $^\circ\text{C}$  above  $+70^\circ\text{C}$ ).....471mW

Operating Temperature Range .....-40 $^\circ\text{C}$  to +85 $^\circ\text{C}$   
 Storage Temperature Range .....-65 $^\circ\text{C}$  to +150 $^\circ\text{C}$   
 Lead Temperature (soldering, 10s) .....+300 $^\circ\text{C}$

Stresses beyond those listed under "Absolute Maximum Ratings" may cause permanent damage to the device. These are stress ratings only, and functional operation of the device at these or any other conditions beyond those indicated in the operational sections of the specifications is not implied. Exposure to absolute maximum rating conditions for extended periods may affect device reliability.

## DC ELECTRICAL CHARACTERISTICS

( $V_{CC} = +5V$ ,  $V_{EE} = -5V$ ,  $R_L = \infty$ ,  $T_A = T_{MIN}$  to  $T_{MAX}$ , unless otherwise noted. Typical values are at  $T_A = +25^\circ\text{C}$ .)

PARAMETER	SYMBOL	CONDITIONS		MIN	TYP	MAX	UNITS	
Operating Supply Voltage	$V_S$	Guaranteed by PSR test		$\pm 4$		$\pm 5.5$	V	
Quiescent Supply Current	$I_S$	Per buffer, $V_{IN} = 0V$			2.2	4	mA	
Input Offset Voltage	$V_{OS}$	$V_{IN} = 0V$			1	15	mV	
Input Offset Voltage Drift	$TCV_{OS}$	$V_{IN} = 0V$			20		$\mu\text{V}/^\circ\text{C}$	
Input Offset Voltage Matching		MAX4203/MAX4204/MAX4205			0.4		mV	
Input Bias Current	$I_B$				0.8	10	$\mu\text{A}$	
Input Resistance	$R_{IN}$	(Note 1)			500		k $\Omega$	
Voltage Gain	$A_v$	$-3.0V \leq V_{OUT} \leq 3.0V$	MAX4200/MAX4203, $R_{EXT} = 150\Omega$	0.9	0.96	1.1	V/V	
			MAX4201/MAX4204, $R_{EXT} = 50\Omega$	0.42	0.50	0.58		
			MAX4202/MAX4205, $R_{EXT} = 75\Omega$	0.41	0.50	0.59		
Power-Supply Rejection	PSR	$V_S = \pm 4V$ to $\pm 5.5V$		55	72		dB	
Output Resistance	$R_{OUT}$	$f = \text{DC}$	MAX4200/MAX4203	8			$\Omega$	
			MAX4201/MAX4204	50				
			MAX4202/MAX4205	75				
Output Current	$I_{OUT}$	$R_L = 30\Omega$	MAX4200/MAX4203	$\pm 90$			mA	
			MAX4201/MAX4204	$\pm 52$				
			MAX4202/MAX4205	$\pm 44$				
Short-Circuit Output Current	$I_{SC}$	Sinking or sourcing	MAX4200/MAX4203	150			mA	
			MAX4201/MAX4204	90				
			MAX4202/MAX4205	75				
Output-Voltage Swing	$V_{OUT}$	MAX4200/MAX4203	$R_L = 150\Omega$	$\pm 3.3$	$\pm 3.8$		V	
			$R_L = 100\Omega$	$\pm 3.2$	$\pm 3.7$			
			$R_L = 37.5\Omega$	$\pm 3.3$				
			MAX4201/MAX4204	$R_L = 50\Omega$	$\pm 1.9$			$\pm 2.1$
			MAX4202/MAX4205	$R_L = 75\Omega$	$\pm 2.0$			$\pm 2.3$

# Ultra-High-Speed, Low-Noise, Low-Power, SOT23 Open-Loop Buffers

**MAX4200-MAX4205**

## AC ELECTRICAL CHARACTERISTICS

( $V_{CC} = +5V$ ,  $V_{EE} = -5V$ ,  $R_L = 100\Omega$  for MAX4200/MAX4201/MAX4203/MAX4204,  $R_L = 150\Omega$  for MAX4202/MAX4205,  $T_A = T_{MIN}$  to  $T_{MAX}$ , unless otherwise noted. Typical values are at  $T_A = +25^\circ C$ .)

PARAMETER	SYMBOL	CONDITIONS		MIN	TYP	MAX	UNITS
-3dB Bandwidth	BW(-3dB)	$V_{OUT} \leq 100mV_{RMS}$	MAX4200		660		MHz
			MAX4201/MAX4202		780		
			MAX4203		530		
			MAX4204/MAX4205		720		
0.1dB Bandwidth	BW(0.1dB)	$V_{OUT} \leq 100mV_{RMS}$	MAX4200		220		MHz
			MAX4201/MAX4202		280		
			MAX4203		130		
			MAX4204/MAX4205		230		
Full-Power Bandwidth	FPBW	$V_{OUT} \leq 2V_{P-P}$	MAX4200/MAX4201/MAX4202		490		MHz
			MAX4203/MAX4204/MAX4205		310		
Slew Rate	SR	$V_{OUT} = 2V$ step			4200		V/ $\mu s$
Group Delay Time					405		ps
Settling Time to 0.1%	$t_s$	$V_{OUT} = 2V$ step			12		ns
Spurious-Free Dynamic Range	SFDR	$V_{OUT} = 2V_{P-P}$	MAX4200/MAX4201/ MAX4202	f = 5MHz	-48		dBc
				f = 20MHz	-45		
				f = 100MHz	-34		
			MAX4203/MAX4204/ MAX4205	f = 5MHz	-47		
				f = 20MHz	-44		
				f = 100MHz	-32		
Harmonic Distortion	HD	MAX4200/MAX4201/ MAX4202, f = 500kHz, $V_{OUT} = 2V_{P-P}$	Second harmonic	-72		dBc	
			Third harmonic	-48			
			Total harmonic	-48			
		MAX4203/MAX4204/ MAX4205, f = 500kHz, $V_{OUT} = 2V_{P-P}$	Second harmonic	-83			
			Third harmonic	-47			
			Total harmonic	-47			
Differential Gain Error	DG	NTSC, $R_L = 150\Omega$			1.3		%
Differential Phase Error	DP	NTSC, $R_L = 150\Omega$			0.15		degrees
Input Voltage-Noise Density	$e_n$	f = 1MHz			2.1		nV/ $\sqrt{Hz}$
Input Current-Noise Density	$i_n$	f = 1MHz			0.8		pA/ $\sqrt{Hz}$
Input Capacitance	$C_{IN}$				2		pF
Output Impedance	$Z_{OUT}$	f = 10MHz			6		$\Omega$
Amplifier Crosstalk	XTALK	$V_{OUT} = 2V_{P-P}$	f = 10MHz		-87		dB
			f = 100MHz		-65		

**Note 1:** Tested with no load; increasing load will decrease input impedance.

# Ultra-High-Speed, Low-Noise, Low-Power, SOT23 Open-Loop Buffers

## Typical Operating Characteristics

( $V_{CC} = +5V$ ,  $V_{EE} = -5V$ ,  $R_L = 100\Omega$  for MAX4200/MAX4201/MAX4203/MAX4204,  $R_L = 150\Omega$  for MAX4202/MAX4205, unless otherwise noted.)

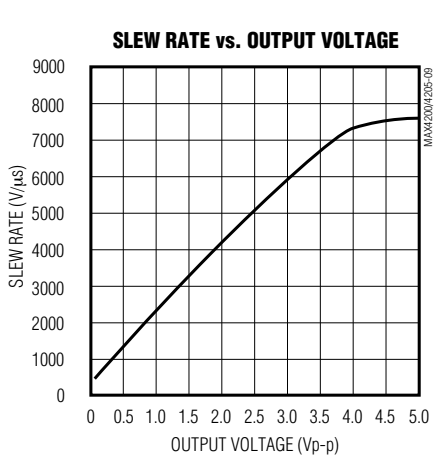
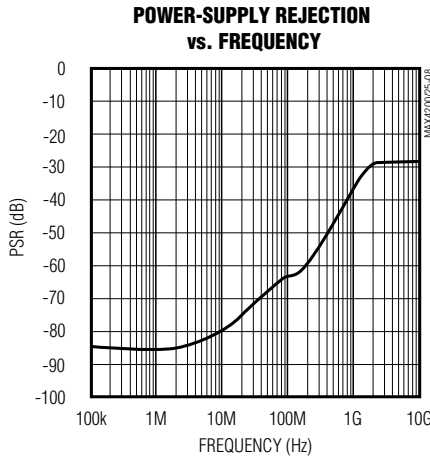
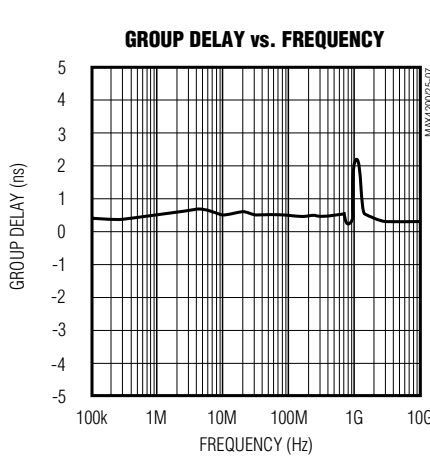
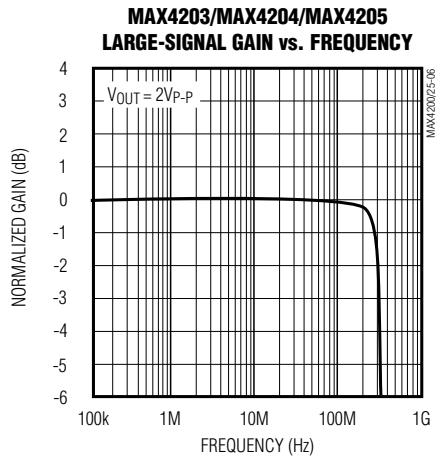
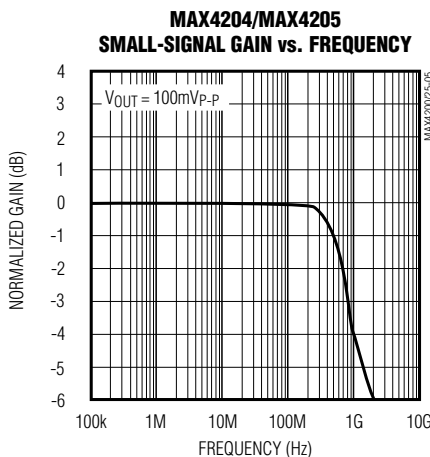
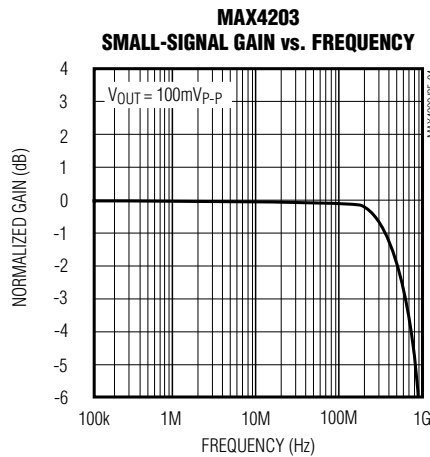
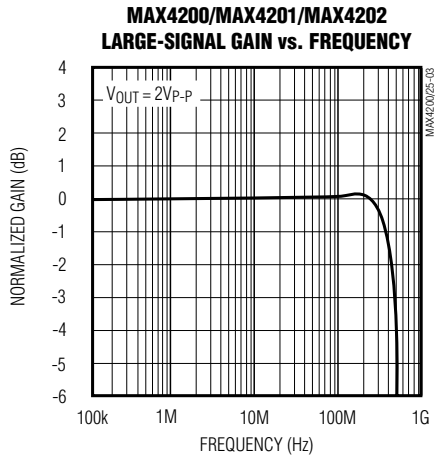
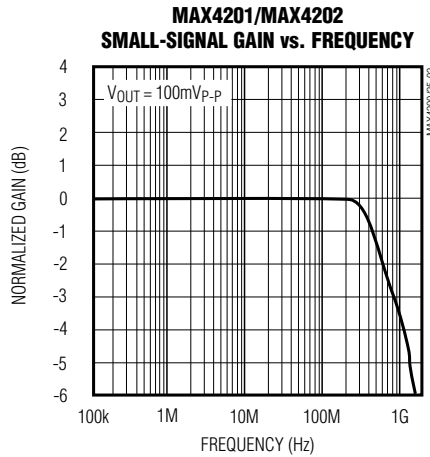
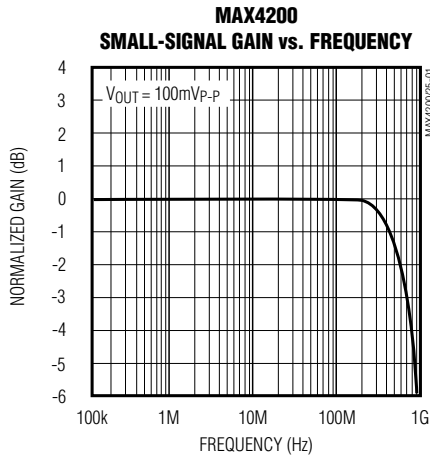

# Ultra-High-Speed, Low-Noise, Low-Power, SOT23 Open-Loop Buffers

## Typical Operating Characteristics (continued)

( $V_{CC} = +5V$ ,  $V_{EE} = -5V$ ,  $R_L = 100\Omega$  for MAX4200/MAX4201/MAX4203/MAX4204,  $R_L = 150\Omega$  for MAX4202/MAX4205, unless otherwise noted.)

**MAX4200-MAX4205**

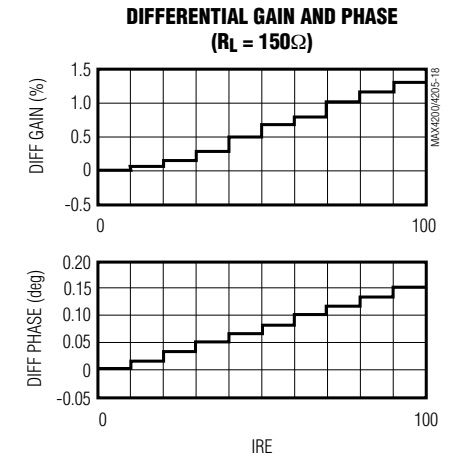
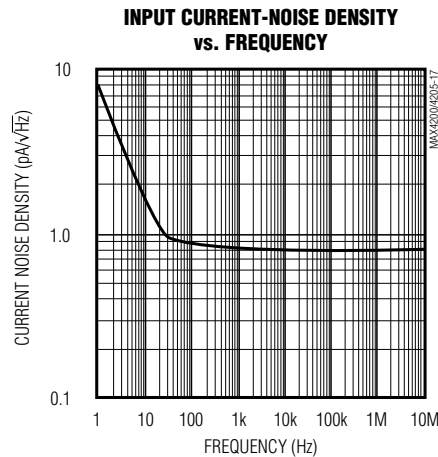
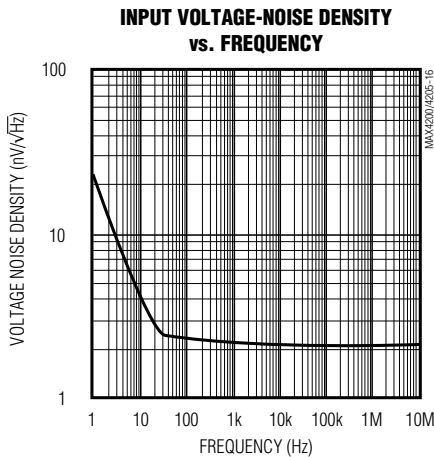
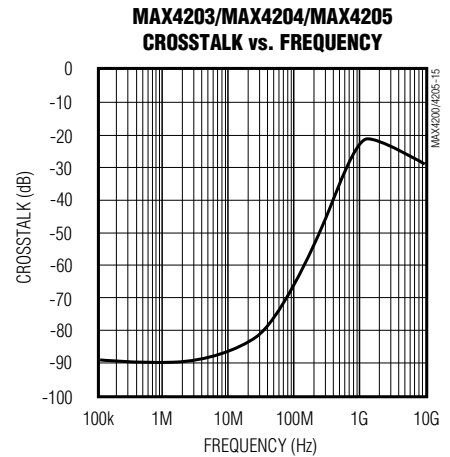
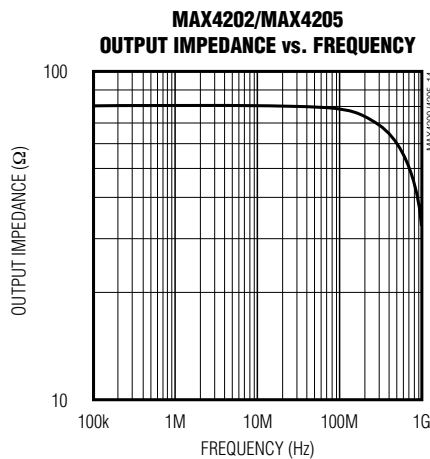
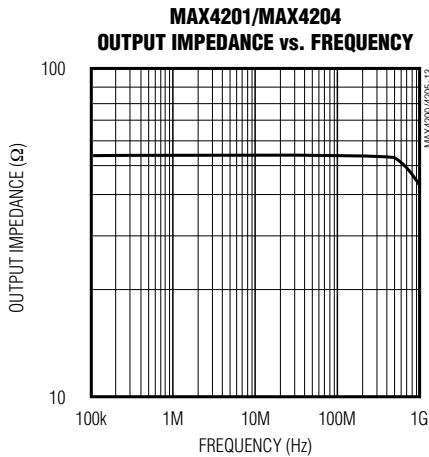
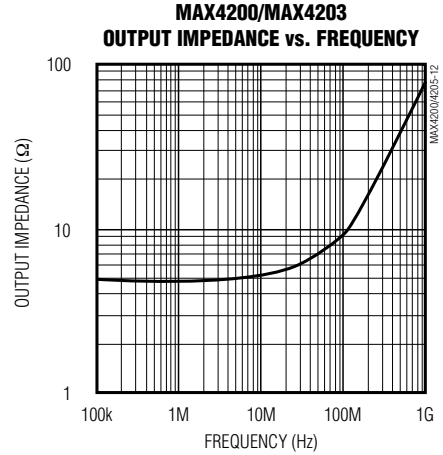
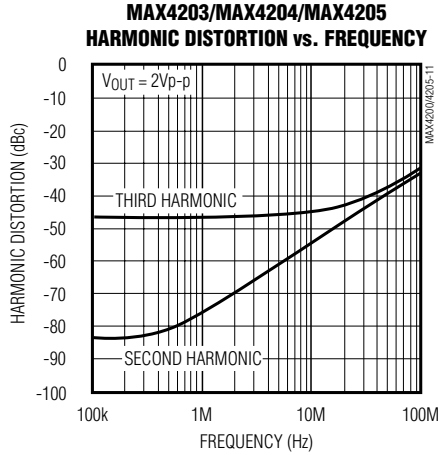
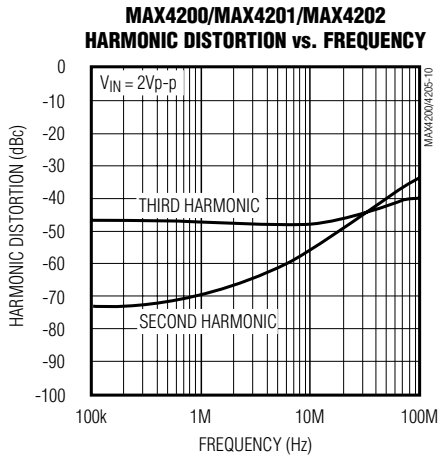

# Ultra-High-Speed, Low-Noise, Low-Power, SOT23 Open-Loop Buffers

## Typical Operating Characteristics (continued)

( $V_{CC} = +5V$ ,  $V_{EE} = -5V$ ,  $R_L = 100\Omega$  for MAX4200/MAX4201/MAX4203/MAX4204,  $R_L = 150\Omega$  for MAX4202/MAX4205, unless otherwise noted.)

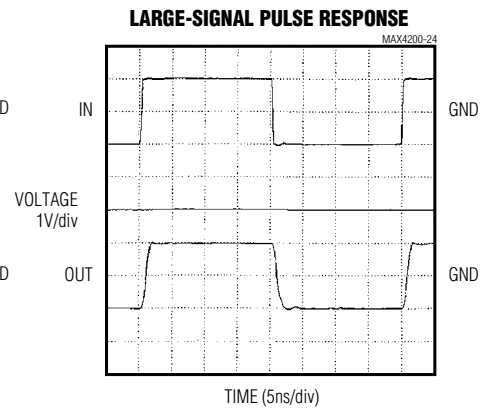
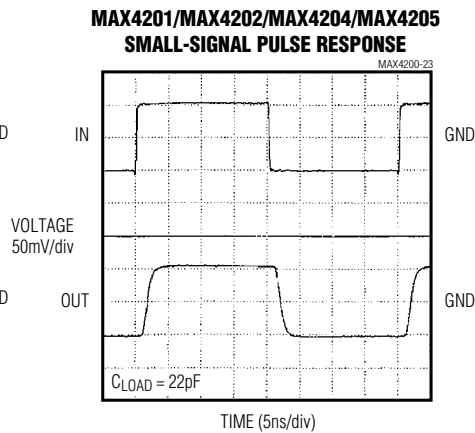
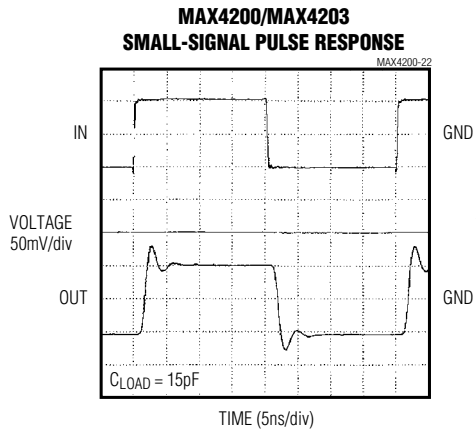
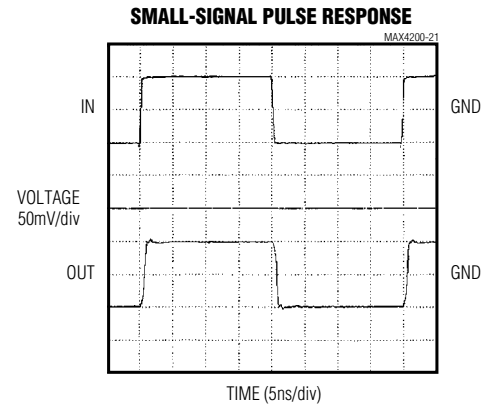
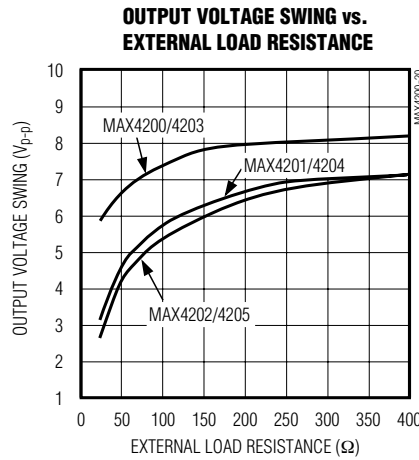
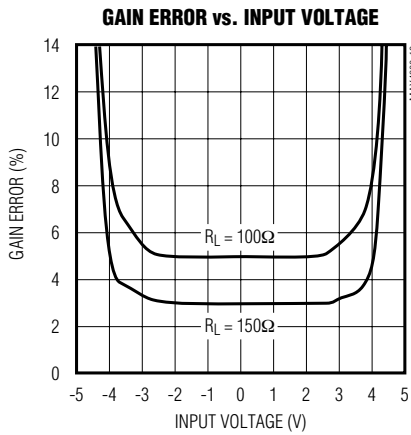

# Ultra-High-Speed, Low-Noise, Low-Power, SOT23 Open-Loop Buffers

## Typical Operating Characteristics (continued)

( $V_{CC} = +5V$ ,  $V_{EE} = -5V$ ,  $R_L = 100\Omega$  for MAX4200/MAX4201/MAX4203/MAX4204,  $R_L = 150\Omega$  for MAX4202/MAX4205, unless otherwise noted.)

**MAX4200-MAX4205**

**MAX4200/MAX4203  
LARGE-SIGNAL PULSE RESPONSE**

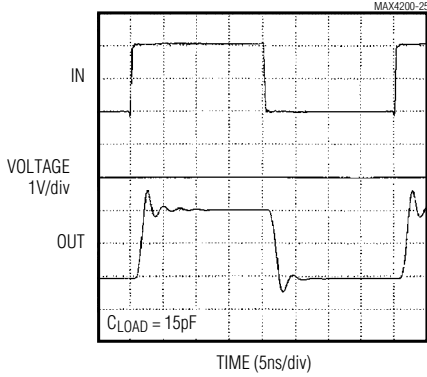

**MAX4201/MAX4202/MAX4204/MAX4205  
LARGE-SIGNAL PULSE RESPONSE**

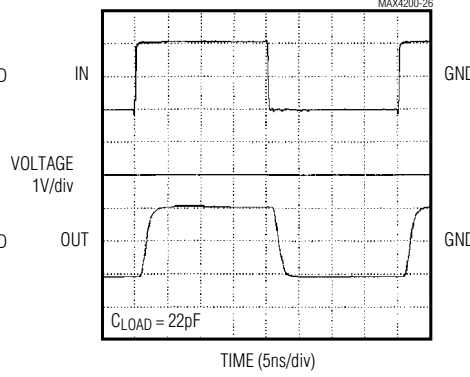

**SUPPLY CURRENT (PER BUFFER)  
vs. TEMPERATURE**

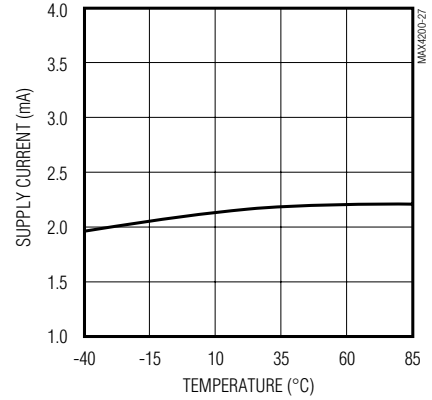

**INPUT OFFSET VOLTAGE  
vs. TEMPERATURE**

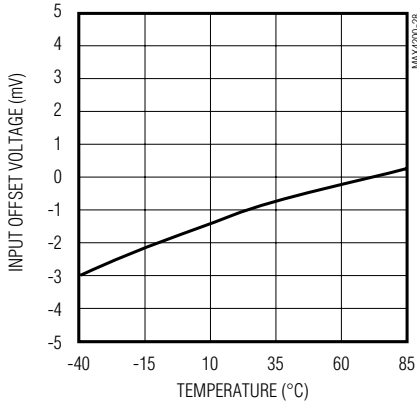

**INPUT BIAS CURRENT  
vs. TEMPERATURE**

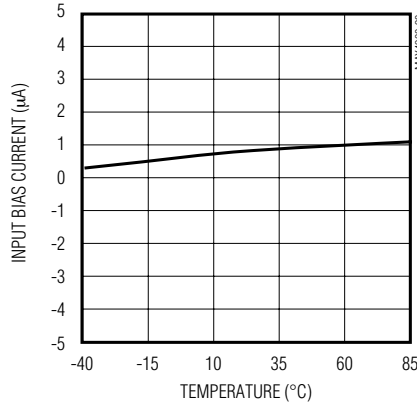

**MAX4200/MAX4203  
OUTPUT VOLTAGE SWING  
vs. TEMPERATURE**

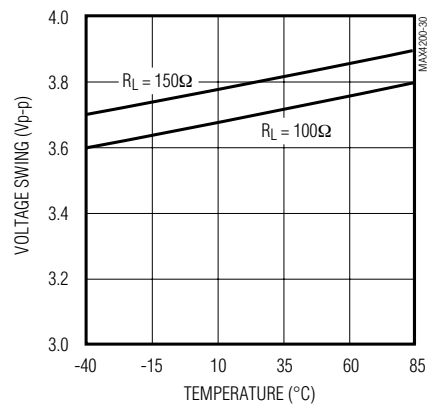



# Ultra-High-Speed, Low-Noise, Low-Power, SOT23 Open-Loop Buffers

## Pin Description

PIN			NAME	FUNCTION
MAX4200/MAX4201/MAX4202		MAX4203 MAX4204 MAX4205		
SOT23-5	SO	SO/ $\mu$ MAX		
1	1, 2, 5, 8	—		
3	3	—	IN	Buffer Input
—	—	1	IN1	Buffer 1 Input
—	—	2	OUT1	Buffer 1 Output
2	4	—	VEE	Negative Power Supply
—	—	3	VEE1	Negative Power Supply for Buffer 1
—	—	4	VEE2	Negative Power Supply for Buffer 2
—	—	5	IN2	Buffer 2 Input
—	—	6	OUT2	Buffer 2 Output
5	6	—	OUT	Buffer Output
4	7	—	VCC	Positive Power Supply
—	—	7	VCC2	Positive Power Supply for Buffer 2
—	—	8	VCC1	Positive Power Supply for Buffer 1

### Detailed Description

The MAX4200–MAX4205 wide-band, open-loop buffers feature high slew rates, high output current, low 2.1nV/Hz voltage-noise density, and excellent capacitive-load-driving capability. The MAX4200/MAX4203 are single/dual buffers with up to 660MHz bandwidth, 230MHz 0.1dB gain flatness, and a 4200V/ $\mu$ s slew rate. The MAX4201/MAX4204 single/dual buffers with integrated 50 $\Omega$  output termination resistors, up to 780MHz bandwidth, 280MHz gain flatness, and a 4200V/ $\mu$ s slew rate, are ideally suited for driving high-speed signals over 50 $\Omega$  cables. The MAX4202/MAX4205 provide bandwidths up to 720MHz, 230MHz gain flatness, 4200V/ $\mu$ s slew rate, and integrated 75 $\Omega$  output termination resistors for driving 75 $\Omega$  cables.

With an open-loop gain that is slightly less than +1V/V, these devices do not have to be compensated with the internal dominant pole (and its associated phase shift) that is present in voltage-feedback devices. This feature allows the MAX4200–MAX4205 to achieve a nearly constant group delay time of 405ps over their full frequency range, making them well suited for a variety of RF and IF signal-processing applications.

These buffers operate with  $\pm$ 5V supplies and consume only 2.2mA of quiescent supply current per buffer while providing up to  $\pm$ 90mA of output current drive capability.

### Applications Information

#### Power Supplies

The MAX4200–MAX4205 operate with dual supplies from  $\pm$ 4V to  $\pm$ 5.5V. Both VCC and VEE should be bypassed to the ground plane with a 0.1 $\mu$ F capacitor located as close to the device pin as possible.

#### Layout Techniques

Maxim recommends using microstrip and stripline techniques to obtain full bandwidth. To ensure that the PC board does not degrade the amplifier's performance, design it for a frequency greater than 6GHz. Pay careful attention to inputs and outputs to avoid large parasitic capacitance. Whether or not you use a constant-impedance board, observe the following guidelines when designing the board:

- Do not use wire-wrap boards, because they are too inductive.
- Do not use IC sockets, because they increase parasitic capacitance and inductance.

# Ultra-High-Speed, Low-Noise, Low-Power, SOT23 Open-Loop Buffers

- Use surface-mount instead of through-hole components for better high-frequency performance.
- Use a PC board with at least two layers; it should be as free from voids as possible.
- Keep signal lines as short and as straight as possible. Do not make 90° turns; round all corners.

## Input Impedance

The MAX4200–MAX4205 input impedance looks like a 500k $\Omega$  resistor in parallel with a 2pF capacitor. Since these devices operate without negative feedback, there is no loop gain to transform the input impedance upward, as in closed-loop buffers. As a consequence, the input impedance is directly related to the output impedance. If the output load impedance decreases, the input impedance also decreases. Inductive input sources (such as an unterminated cable) may react with the input capacitance and produce some peaking in the buffer's frequency response. This effect can usually be minimized by using a properly terminated transmission line at the buffer input, as shown in Figure 1.

## Output Current and Gain Sensitivity

The absence of negative feedback means that open-loop buffers have no loop gain to reduce their effective output impedance. As a result, open-loop devices usually suffer from decreasing gain as the output current is decreased. The MAX4200–MAX4205 include local feedback around the buffer's class-AB output stage to ensure low output impedance and reduce gain sensitivity to load variations. This feedback also produces demand-driven current bias to the output transistors for  $\pm 90\text{mA}$  (MAX4200/MAX4203) drive capability that is relatively independent of the output voltage (see *Typical Operating Characteristics*).

## Output Capacitive Loading and Stability

The MAX4200–MAX4205 provide maximum AC performance with no load capacitance. This is the case when the load is a properly terminated transmission line. However, these devices are designed to drive any load capacitance without oscillating, but with reduced AC performance.

Since the MAX4200–MAX4205 operate in an open-loop configuration, there is no negative feedback to be transformed into positive feedback through phase shift introduced by a capacitive load. Therefore, these devices will not oscillate with capacitive loading, unlike similar buffers operating in a closed-loop configuration. However, a capacitive load reacting with the buffer's output impedance can still affect circuit performance. A capacitive load will form a lowpass filter with the buffer's output resistance, thereby limiting system

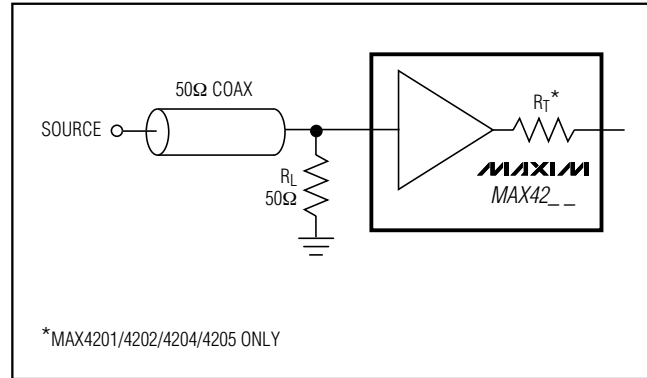

Figure 1. Using a Properly Terminated Input Source

bandwidth. With higher capacitive loads, bandwidth is dominated by the RC network formed by R<sub>T</sub> and C<sub>L</sub>; the bandwidth of the buffer itself is much higher. Also note that the isolation resistor forms a divider that decreases the voltage delivered to the load.

Another concern when driving capacitive loads results from the amplifier's output impedance, which looks inductive at high frequency. This inductance forms an L-C resonant circuit with the capacitive load and causes peaking in the buffer's frequency response.

Figure 2 shows the frequency response of the MAX4200/MAX4203 under different capacitive loads. To settle out some of the peaking, the output requires an isolation resistor like the one shown in Figure 3. Figure 4 is a plot of the MAX4200/MAX4203 frequency response with capacitive loading and a 10 $\Omega$  isolation resistor. In many applications, the output termination resistors included in the MAX4201/MAX4202/ MAX4204/MAX4205 will serve this purpose, reducing component count and board space. Figure 5 shows the MAX4201/MAX4202/ MAX4204/MAX4205 frequency response with capacitive loads of 47pF, 68pF, and 120pF.

## Coaxial Cable Drivers

Coaxial cable and other transmission lines are easily driven when properly terminated at both ends with their characteristic impedance. Driving back-terminated transmission lines essentially eliminates the line's capacitance. The MAX4201/MAX4204, with their integrated 50 $\Omega$  output termination resistors, are ideal for driving 50 $\Omega$  cables. The MAX4202/MAX4205 include integrated 75 $\Omega$  termination resistors for driving 75 $\Omega$  cables. Note that the output termination resistor forms a voltage divider with the load resistance, thereby decreasing the amplitude of the signal at the receiving end of the cable by one half (see the *Typical Application Circuit*).

# Ultra-High-Speed, Low-Noise, Low-Power, SOT23 Open-Loop Buffers

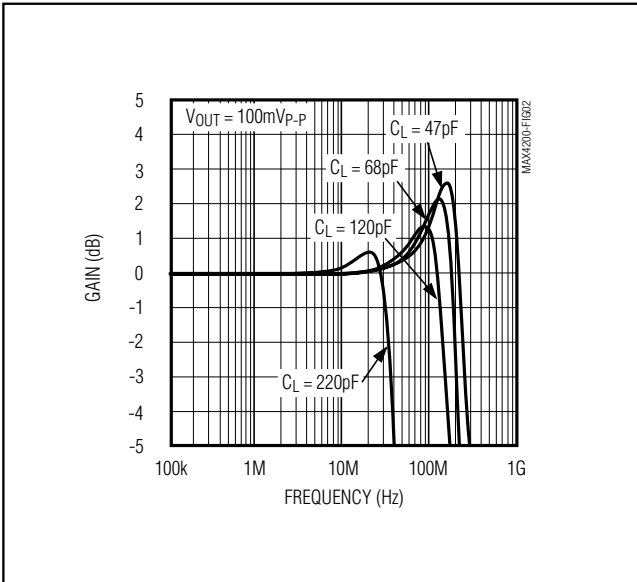

Figure 2. MAX4200/MAX4203 Small-Signal Gain vs. Frequency with Load Capacitance and No Isolation Resistor

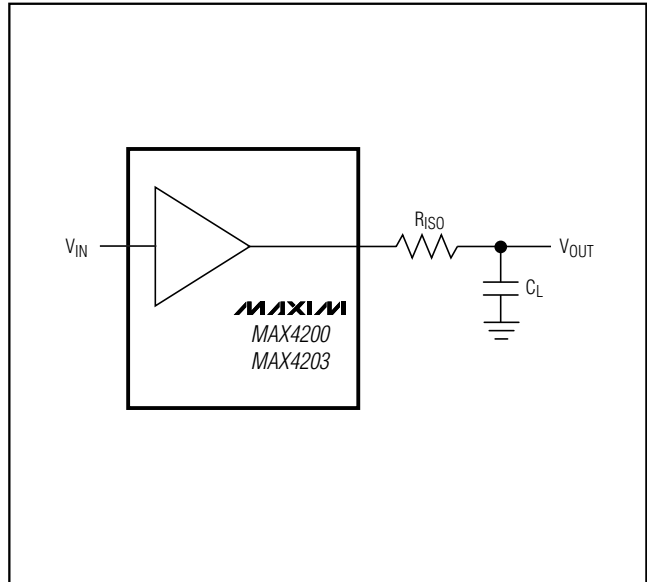

Figure 3. Driving a Capacitive Load Through an Isolation Resistor

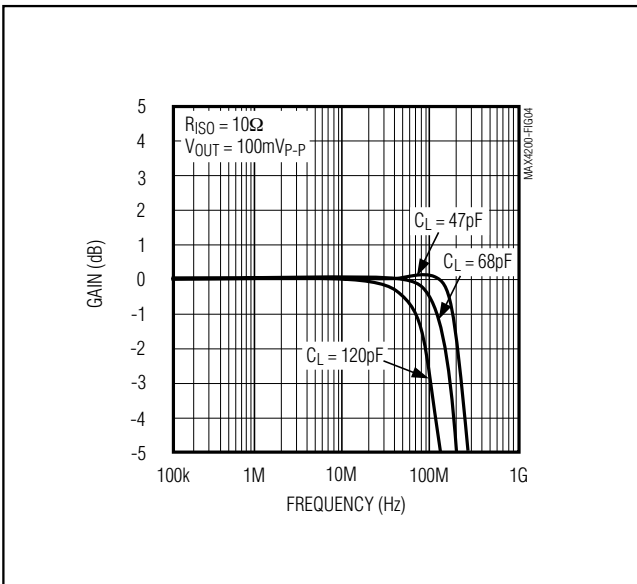

Figure 4. MAX4200/MAX4203 Small-Signal Gain vs. Frequency with Load Capacitance and  $10\Omega$  Isolation Resistor

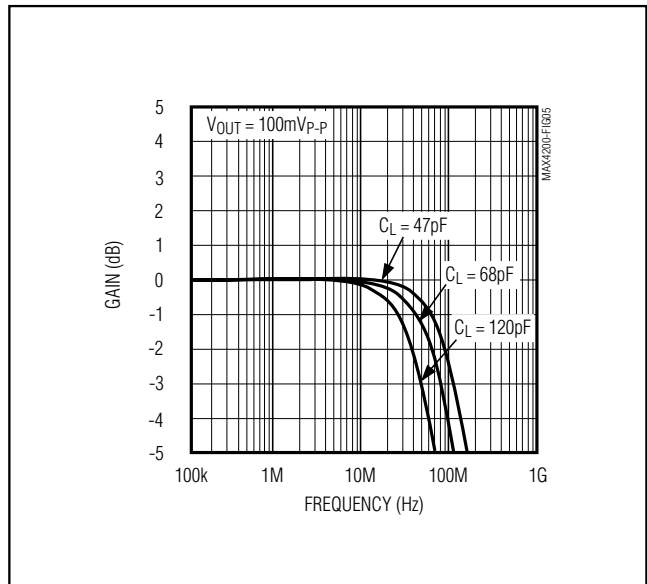
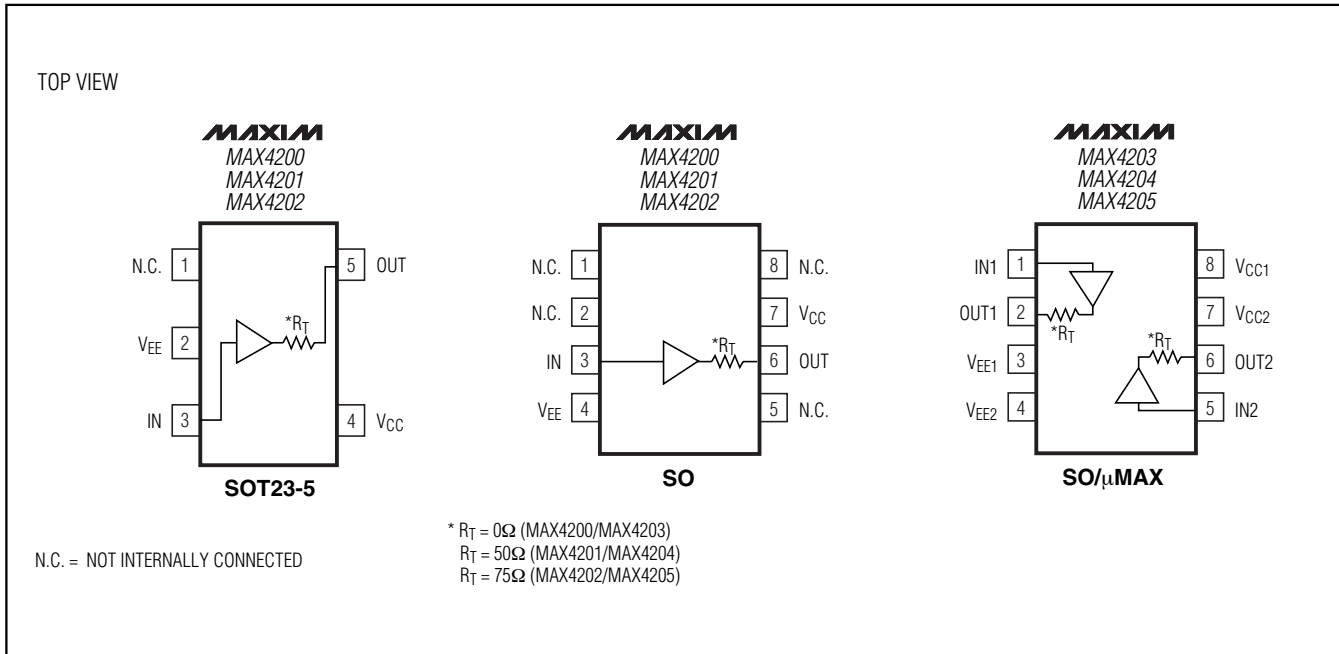

Figure 5. MAX4201/MAX4202/MAX4204/MAX4205 Small-Signal Gain vs. Frequency with Capacitive Load and No External Isolation Resistor

# Ultra-High-Speed, Low-Noise, Low-Power, SOT23 Open-Loop Buffers

## Pin Configurations

**MAX4200-MAX4205**



## Chip Information

TRANSISTOR COUNTS:

MAX4200/MAX4201/MAX4202: 33

MAX4203/MAX4204/MAX4205: 67

SUBSTRATE CONNECTED TO  $V_{EE}$

# Ultra-High-Speed, Low-Noise, Low-Power, SOT23 Open-Loop Buffers

## Package Information

(The package drawing(s) in this data sheet may not reflect the most current specifications. For the latest package outline information go to [www.maxim-ic.com/packages](http://www.maxim-ic.com/packages).)

TOP VIEW

FRONT VIEW

SIDE VIEW

DIM	INCHES		MILLIMETERS	
	MIN	MAX	MIN	MAX
A	0.053	0.069	1.35	1.75
A1	0.004	0.010	0.10	0.25
B	0.014	0.019	0.35	0.49
C	0.007	0.010	0.19	0.25
e	0.050 BSC		1.27 BSC	
E	0.150	0.157	3.80	4.00
H	0.228	0.244	5.80	6.20
L	0.016	0.050	0.40	1.27

VARIATIONS:

DIM	INCHES		MILLIMETERS		N	MS012
	MIN	MAX	MIN	MAX		
D	0.189	0.197	4.80	5.00	8	AA
D	0.337	0.344	8.55	8.75	14	AB
D	0.386	0.394	9.80	10.00	16	AC

SOICN1EPS

**NOTES:**

1. D&E DO NOT INCLUDE MOLD FLASH.
2. MOLD FLASH OR PROTRUSIONS NOT TO EXCEED 0.15mm (.006").
3. LEADS TO BE COPLANAR WITHIN 0.10mm (.004").
4. CONTROLLING DIMENSION: MILLIMETERS.
5. MEETS JEDEC MS012.
6. N = NUMBER OF PINS.

<b>DALLAS SEMICONDUCTOR</b> <b>MAXIM</b>			
PROPRIETARY INFORMATION			
TITLE: PACKAGE OUTLINE, .150" SOIC			
APPROVAL	DOCUMENT CONTROL NO. 21-0041	REV. B	1/1

# Ultra-High-Speed, Low-Noise, Low-Power, SOT23 Open-Loop Buffers

## Package Information (continued)

(The package drawing(s) in this data sheet may not reflect the most current specifications. For the latest package outline information go to [www.maxim-ic.com/packages](http://www.maxim-ic.com/packages).)

MAX4200-MAX4205

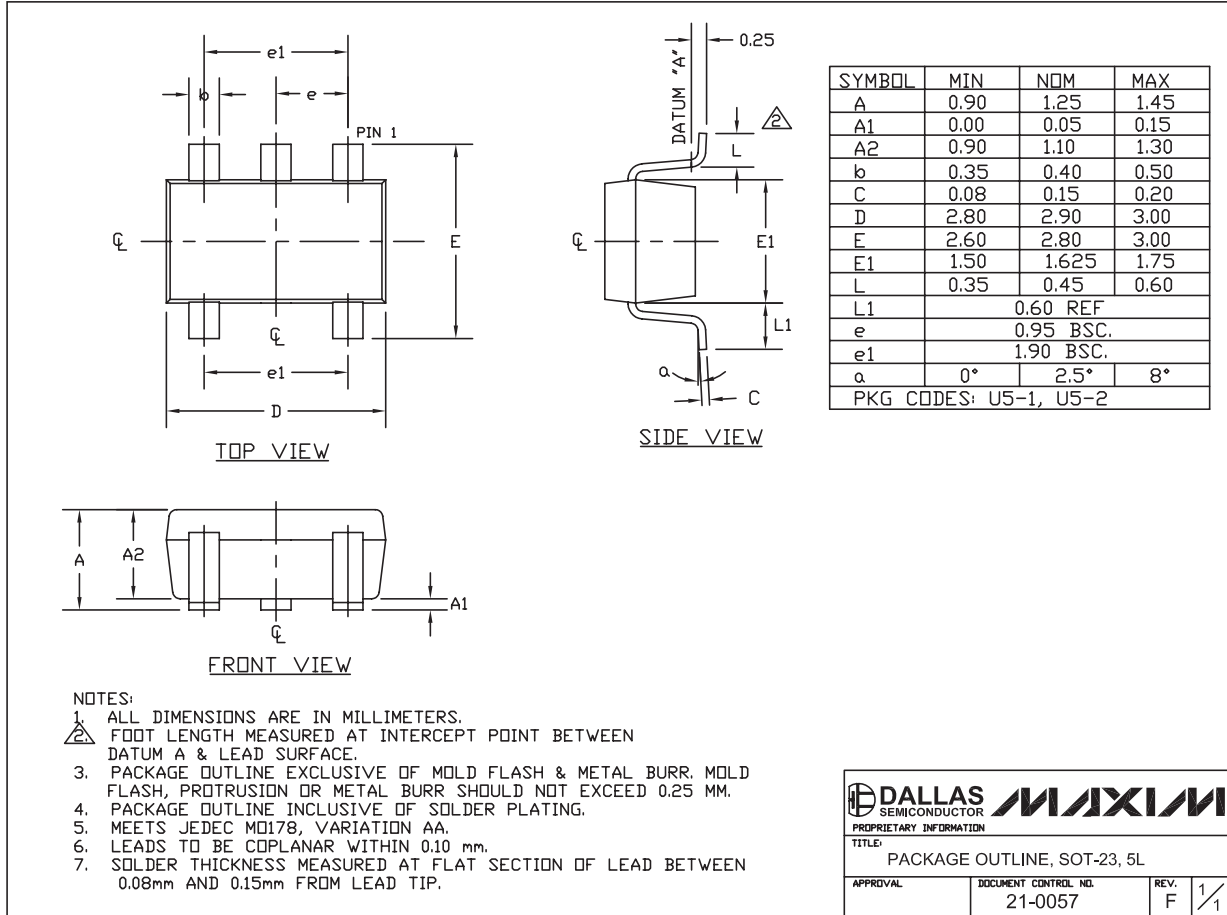

SOT-23 5L EPS

# Ultra-High-Speed, Low-Noise, Low-Power, SOT23 Open-Loop Buffers

## Package Information (continued)

(The package drawing(s) in this data sheet may not reflect the most current specifications. For the latest package outline information go to [www.maxim-ic.com/packages](http://www.maxim-ic.com/packages).)

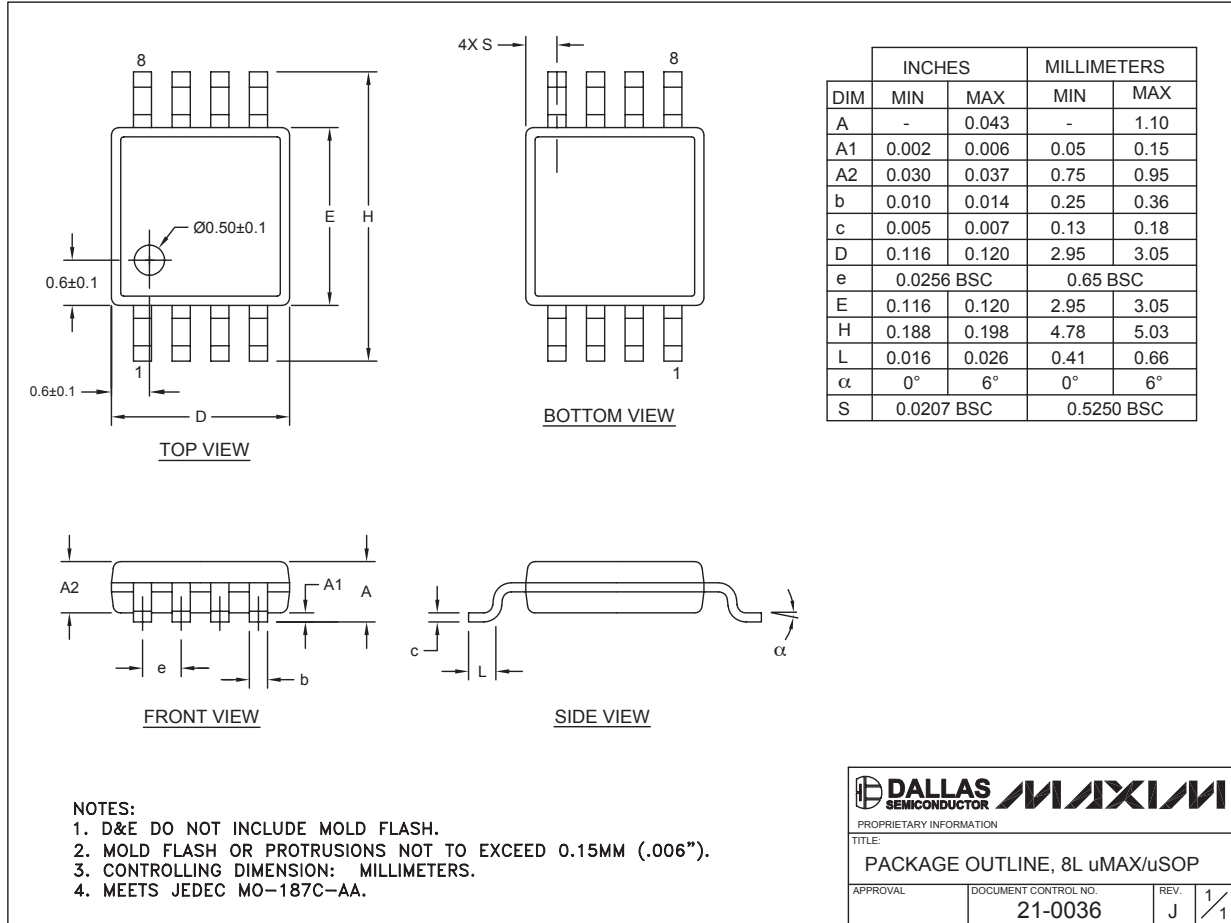

8LUMAXD.EPS

## Revision History

Pages changed at Rev 3: 1-5, 8, 10-14

Maxim cannot assume responsibility for use of any circuitry other than circuitry entirely embodied in a Maxim product. No circuit patent licenses are implied. Maxim reserves the right to change the circuitry and specifications without notice at any time.

14 **Maxim Integrated Products, 120 San Gabriel Drive, Sunnyvale, CA 94086 408-737-7600**