



Chipsmall Limited consists of a professional team with an average of over 10 year of expertise in the distribution of electronic components. Based in Hongkong, we have already established firm and mutual-benefit business relationships with customers from,Europe,America and south Asia,supplying obsolete and hard-to-find components to meet their specific needs.

With the principle of “Quality Parts,Customers Priority,Honest Operation,and Considerate Service”,our business mainly focus on the distribution of electronic components. Line cards we deal with include Microchip,ALPS,ROHM,Xilinx,Pulse,ON,Everlight and Freescale. Main products comprise IC,Modules,Potentiometer,IC Socket,Relay,Connector.Our parts cover such applications as commercial,industrial, and automotives areas.

We are looking forward to setting up business relationship with you and hope to provide you with the best service and solution. Let us make a better world for our industry!



## Contact us

Tel: +86-755-8981 8866 Fax: +86-755-8427 6832

Email & Skype: info@chipsmall.com Web: www.chipsmall.com

Address: A1208, Overseas Decoration Building, #122 Zhenhua RD., Futian, Shenzhen, China





# Mono/Stereo 2W Switch-Mode (Class-D) Audio Power Amplifiers

MAX4295/MAX4297

## General Description

The MAX4295/MAX4297 mono/stereo, switch-mode (Class-D) audio power amplifiers operate from a single +2.7V to +5.5V supply. They have >85% efficiency and are capable of delivering 2W continuous power to a 4Ω load, making them ideal for portable multimedia and general-purpose high-power audio applications.

The MAX4295/MAX4297 feature a total harmonic distortion plus noise (THD+N) of 0.4% ( $f_{OSC} = 125kHz$ ), low quiescent current of 2.8mA (MAX4295) or 4.6mA (MAX4297), high efficiency, and clickless power-up and shutdown. The SHDN input disables the device and limits supply current to <math>1.5\mu A</math> (MAX4295) or <math>2.3\mu A</math> (MAX4297). Other features include a 1A current limit, thermal protection, and under-voltage lockout.

The MAX4295 (mono) and MAX4297 (stereo) reduce the number of required external components. Both devices have internal high-speed power-MOS transistors, allowing operation as bridge-tied load (BTL) amplifiers. The BTL configuration eliminates the need for isolation capacitors on the output. The frequency-selectable pulse-width modulator (PWM) allows the user to optimize the size and cost of the output filter.

The MAX4295 is offered in a space-saving 16-pin QSOP package, and the MAX4297 is offered in a compact 24-pin SSOP package.

## Applications

- Palmtop/Notebook Computers
- PDA Audio
- Sound Cards
- Game Cards
- Boom Boxes
- AC Amplifiers
- Battery-Powered Speakers
- Cordless Phones
- Portable Equipment

## Features

- ◆ +2.7V to +5.5V Single-Supply Operation
- ◆ 2W/Channel Output Power at 5V  
0.7W/Channel Output Power at 3V
- ◆ 87% Efficiency ( $R_L = 4\Omega$ ,  $P_O = 2W$ , MAX4295)
- ◆ 0.4% THD+N ( $R_L = 4\Omega$ ,  $f_{OSC} = 125kHz$ )
- ◆ Logic-Programmable PWM Frequency Selection (125kHz, 250kHz, 500kHz, 1MHz)
- ◆ Low-Power Shutdown Mode
- ◆ Clickless Transitions Into and Out of Shutdown
- ◆ 1A Current Limit and Thermal Protection
- ◆ Available in Space-Saving Packages  
16-Pin QSOP (MAX4295)  
24-Pin SSOP (MAX4297)

## Ordering Information

PART	TEMP. RANGE	PIN-PACKAGE
MAX4295EEE	-40°C to +85°C	16 QSOP
MAX4295ESE	-40°C to +85°C	16 Narrow SO
MAX4297EAG	-40°C to +85°C	24 SSOP
MAX4297EWG	-40°C to +85°C	24 Wide SO

Pin Configurations appear at end of data sheet.

## Typical Operating Circuit

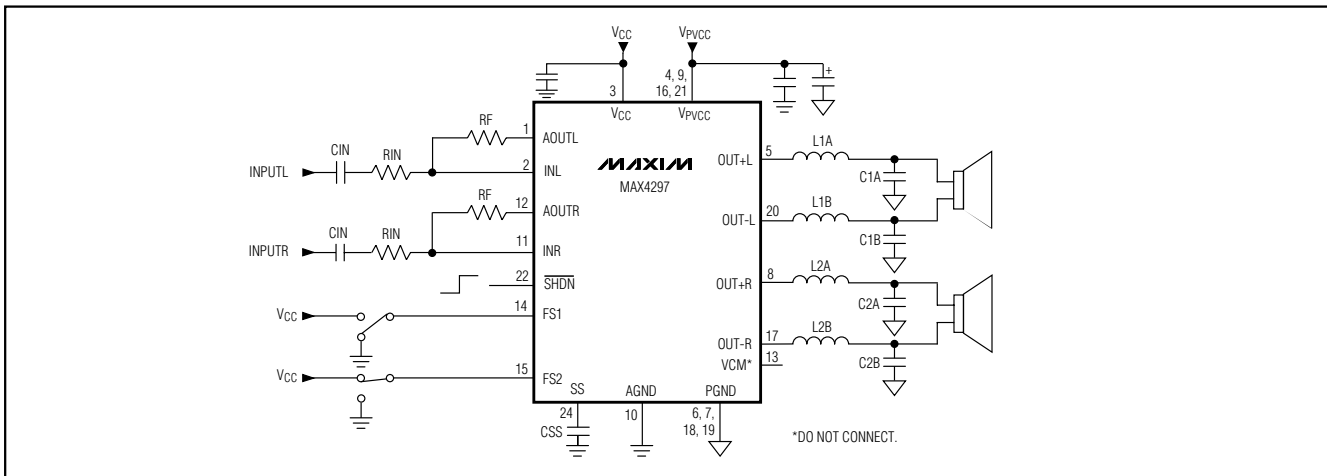

# Mono/Stereo 2W Switch-Mode (Class-D) Audio Power Amplifiers

## ABSOLUTE MAXIMUM RATINGS

V <sub>CC</sub> , PV <sub>CC</sub> to GND or PGND	-0.3V to +6V
PGND to GND	±0.3V
PV <sub>CC</sub> to V <sub>CC</sub>	±0.3V
VCM, SS, AOUT_, IN_	-0.3V to (V <sub>CC</sub> + 0.3V)
SHDN, FS1, FS2	-0.3V to +6V
OUT_	-0.3V to (PV <sub>CC</sub> + 0.3V)
Op Amp Output Short-Circuit Duration (AOUT_)	Indefinite Short Circuit to Either Supply
H-Bridge Short-Circuit Duration (OUT_)	Continuous Short Circuit to PGND, PV <sub>CC</sub> or between OUT+ & OUT-

Continuous Power Dissipation (T <sub>A</sub> = +70°C)	
16-Pin QSOP (derate 8.30mW/°C above +70°C)	667mW
24-Pin SSOP (derate 9.50mW/°C above +70°C)	762mW
16-Pin Narrow SO	
(derate 9.52mW/°C above +70°C)	696mW
24-Pin Wide SO	
(derate 11.76mW/°C above +70°C)	941mW
Operating Temperature Range	
MAX4295E_/MAX4297E_	-40°C to +85°C
Junction Temperature	+150°C
Storage Temperature Range	-65°C to +150°C
Lead Temperature (soldering, 10s)	+300°C

Stresses beyond those listed under "Absolute Maximum Ratings" may cause permanent damage to the device. These are stress ratings only, and functional operation of the device at these or any other conditions beyond those indicated in the operational sections of the specifications is not implied. Exposure to absolute maximum rating conditions for extended periods may affect device reliability.

## ELECTRICAL CHARACTERISTICS

(V<sub>CC</sub> = PV<sub>CC</sub> = +5V, SHDN = V<sub>CC</sub>, FS1 = GND, FS2 = V<sub>CC</sub> (f<sub>OSC</sub> = 250kHz), input amplifier gain = -1V/V, T<sub>A</sub> = T<sub>MIN</sub> to T<sub>MAX</sub>, unless otherwise noted. Typical values are T<sub>A</sub> = +25°C.) (Note 1)

PARAMETER	CONDITIONS		MIN	TYP	MAX	UNITS
<b>GENERAL</b>						
Supply Voltage Range	(Note 2)		2.7		5.5	V
Quiescent Supply Current	Output load not connected	MAX4295		2.8	4	mA
		MAX4297		4.6	8	
Shutdown Supply Current	SHDN = GND	MAX4295		1.5	8	μA
		MAX4297		2.5	15	
Voltage at VCM Pin			0.285 × V <sub>CC</sub>	0.3 × V <sub>CC</sub>	0.315 × V <sub>CC</sub>	V
PWM Frequency	FS1 = GND, FS2 = GND		105	125	145	kHz
	FS1 = GND, FS2 = V <sub>CC</sub>		210	250	290	
	FS1 = V <sub>CC</sub> , FS2 = GND		420	500	580	
	FS1 = V <sub>CC</sub> , FS2 = V <sub>CC</sub>		840	1000	1160	
PWM Frequency Change with V <sub>CC</sub>	V <sub>CC</sub> = 2.7V to 5.5V			±1	±3	kHz/V
Duty Cycle	V <sub>IN</sub> = 0.06 × V <sub>CC</sub>		10.2	12	13.8	%
	V <sub>IN</sub> = 0.30 × V <sub>CC</sub>		49.2	50	50.8	
	V <sub>IN</sub> = 0.54 × V <sub>CC</sub>		86.2	88	89.8	
Duty Cycle Change with V <sub>CC</sub>	V <sub>IN</sub> = 0.3 × V <sub>CC</sub> , V <sub>CC</sub> = 2.7V to 5.5V			±0.02	±0.15	%/V
Switch On-Resistance (each power device)	I <sub>OUT</sub> = 150mA	V <sub>CC</sub> = 5V		0.25	0.5	Ω
		V <sub>CC</sub> = 2.7V		0.35	1.0	
H-Bridge Output Leakage	SHDN = GND			0	±5	μA
H-Bridge Current Limit				1		A
Soft-Start Capacitor Charging Current	V <sub>SS</sub> = 0		0.75	1.35	1.95	μA
Undervoltage Lockout			1.8	2.2	2.6	V
Thermal Shutdown Trip Point				145		°C

# Mono/Stereo 2W Switch-Mode (Class-D) Audio Power Amplifiers

MAX4295/MAX4297

## ELECTRICAL CHARACTERISTICS (continued)

( $V_{CC} = PV_{CC} = +5V$ ,  $\overline{SHDN} = V_{CC}$ ,  $FS1 = GND$ ,  $FS2 = V_{CC}$  ( $f_{OSC} = 250kHz$ ), input amplifier gain =  $-1V/V$ ,  $T_A = T_{MIN}$  to  $T_{MAX}$ , unless otherwise noted. Typical values are  $T_A = +25^{\circ}C$ .)

PARAMETER	CONDITIONS	MIN	TYP	MAX	UNITS
Input Voltage Range			0 to 0.6 $\times V_{CC}$		V
Maximum Output Power	$V_{CC} = +3V$ , $f_{IN} = 1kHz$	$R_L = 8\Omega$	0.4		W
		$R_L = 4\Omega$	0.7		
	$V_{CC} = +5V$ , $f_{IN} = 1kHz$	$R_L = 8\Omega$	1.2		
		$R_L = 4\Omega$	2		
THD Plus Noise	$R_L = 4\Omega$ , $f_{IN} = 1kHz$ , $P_O = 1W$ , $f_{OSC} = 125kHz$		0.4		%
Efficiency	MAX4295, $R_L = 4\Omega$ , $f_{IN} = 1kHz$ , $P_O = 2W$		87		%
Channel Isolation	MAX4297, $f_{IN} = 1kHz$ , $P_O = 2W$		45		dB
<b>LOGIC INPUTS (SHDN, FS1, FS2)</b>					
Logic Input Current	$V_{LOGIC} = 0$ to $V_{CC}$		1	100	nA
Logic Input High Voltage		0.7 $\times$ $V_{CC}$			V
Logic Input Low Voltage				0.3 $\times$ $V_{CC}$	V
<b>INPUT AMPLIFIER</b>					
Input Offset Voltage			$\pm 0.5$	$\pm 4$	mV
VOS Temp Coefficient			$\pm 5$		$\mu V/^{\circ}C$
Input Bias Current	(Note 3)		$\pm 0.05$	$\pm 25$	nA
Input Noise Voltage Density	$f = 10kHz$		32		$nV/\sqrt{Hz}$
Input Capacitance			2.5		pF
Output Resistance			0.01		$\Omega$
AOUT Disabled Mode Leakage Current	$\overline{SHDN} = GND$ , $V_{AOUT} = 0$ to $V_{CC}$		$\pm 0.1$	$\pm 1$	$\mu A$
Short-Circuit Current	AOUT to GND		8		mA
	AOUT to $V_{CC}$		65		
Large-Signal Voltage Gain	$V_{OUT} = 0.2V$ to $4.6V$ , $R_{L(OPAMP)} = 10k\Omega$	78	115		dB
AOUT Voltage Swing	$V_{DIFF} \geq 10mV$ , $R_{L(OPAMP)} = 10k\Omega$	$V_{CC} - V_{OH}$	40	250	mV
		$V_{OL}$	40	100	
Gain Bandwidth Product			1.25		MHz
Power-Supply Rejection	$V_{CC} = +2.7V$ to $+5.5V$	66	90		dB
Maximum Capacitive Load	No sustained oscillations		200		pF

**Note 1:** All devices are 100% production tested at  $T_A = 25^{\circ}C$ . All temperature limits are guaranteed by design.

**Note 2:** Supply Voltage Range guaranteed by PSRR of input amplifier, frequency, duty cycle, and H-bridge on-resistance.

**Note 3:** Guaranteed by design, not production tested.

# Mono/Stereo 2W Switch-Mode (Class-D) Audio Power Amplifiers

## Typical Operating Characteristics

( $V_{CC} = PV_{CC} = +3V$ , input amplifier gain = -1,  $\overline{SHDN} = V_{CC}$ ,  $T_A = +25^\circ C$ , unless otherwise noted.)

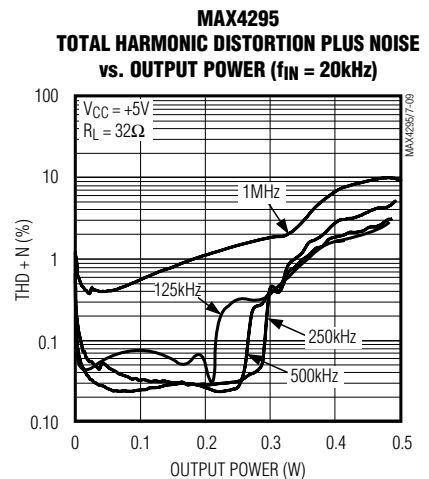
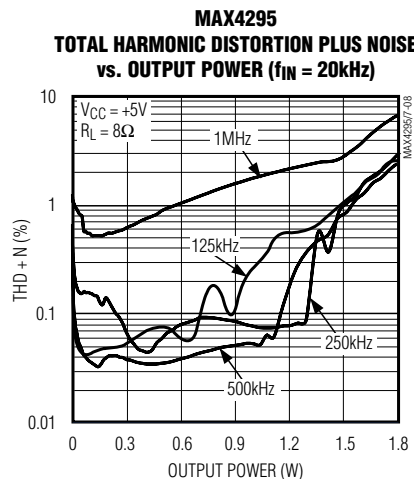
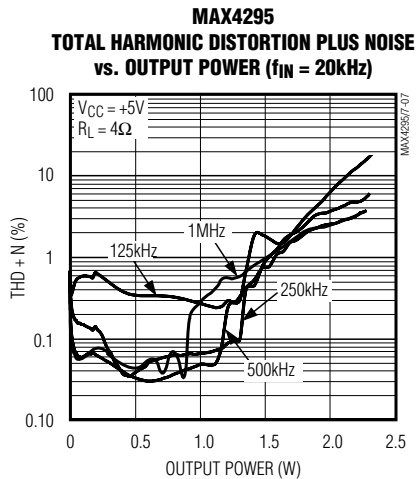
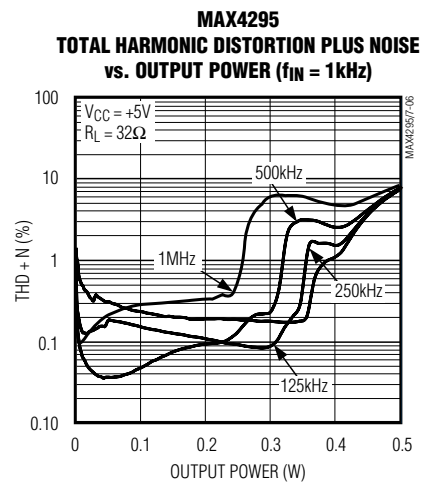
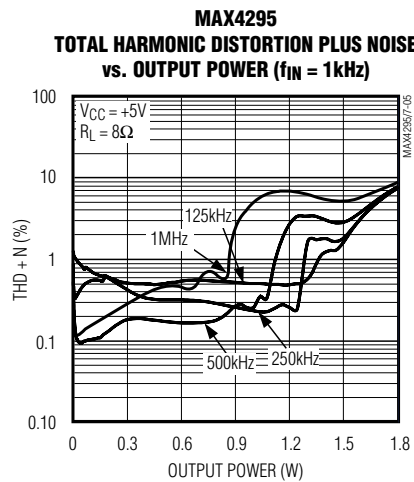
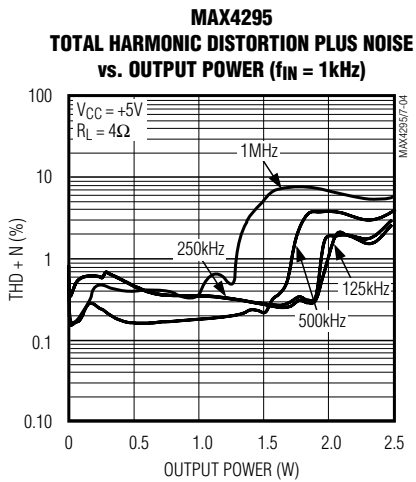
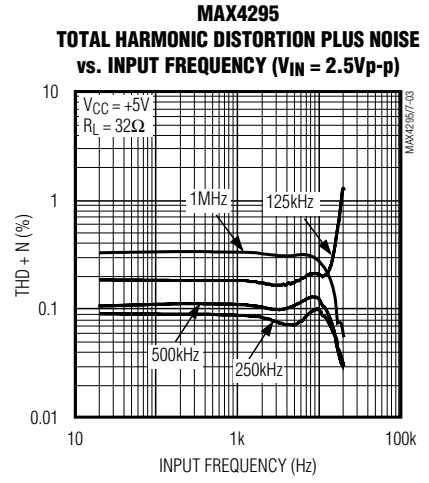
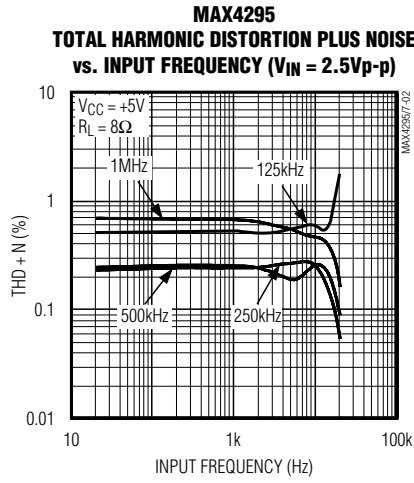
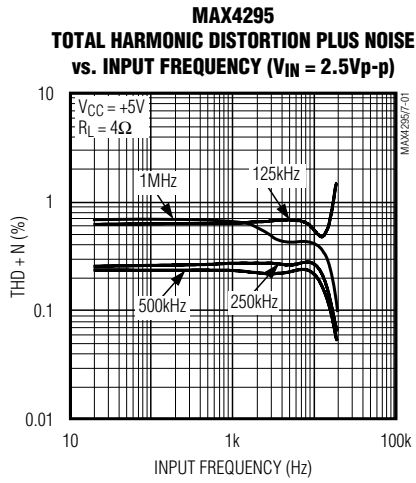

# Mono/Stereo 2W Switch-Mode (Class-D) Audio Power Amplifiers

## Typical Operating Characteristics (continued)

( $V_{CC} = PV_{CC} = +3V$ , input amplifier gain = -1,  $\overline{SHDN} = V_{CC}$ ,  $T_A = +25^\circ C$ , unless otherwise noted.)

MAX4295/MAX4297

**MAX4295**  
TOTAL HARMONIC DISTORTION PLUS NOISE  
vs. INPUT FREQUENCY ( $V_{IN} = 1.5V_{p-p}$ )

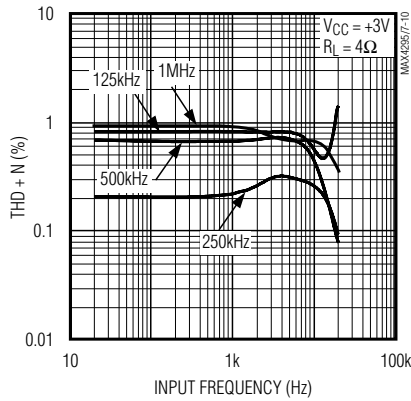

**MAX4295**  
TOTAL HARMONIC DISTORTION PLUS NOISE  
vs. INPUT FREQUENCY ( $V_{IN} = 1.5V_{p-p}$ )

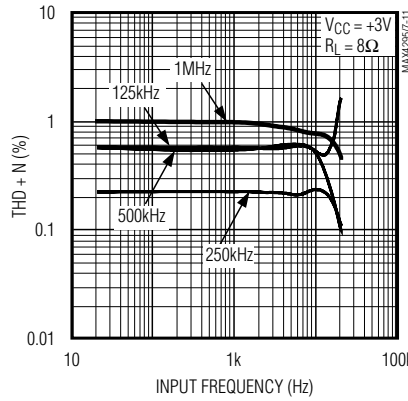

**MAX4295**  
TOTAL HARMONIC DISTORTION PLUS NOISE  
vs. INPUT FREQUENCY ( $V_{IN} = 1.5V_{p-p}$ )

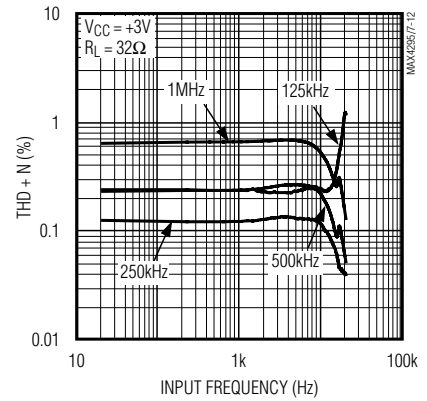

**MAX4295**  
TOTAL HARMONIC DISTORTION PLUS NOISE  
vs. OUTPUT POWER ( $f_{IN} = 1kHz$ )

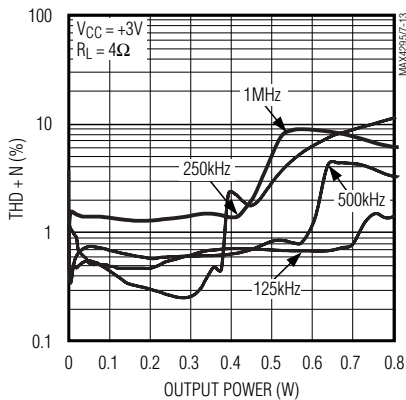

**MAX4295**  
TOTAL HARMONIC DISTORTION PLUS NOISE  
vs. OUTPUT POWER ( $f_{IN} = 1kHz$ )

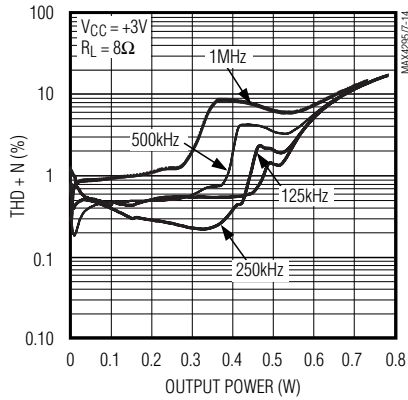

**MAX4295**  
TOTAL HARMONIC DISTORTION PLUS NOISE  
vs. OUTPUT POWER ( $f_{IN} = 1kHz$ )

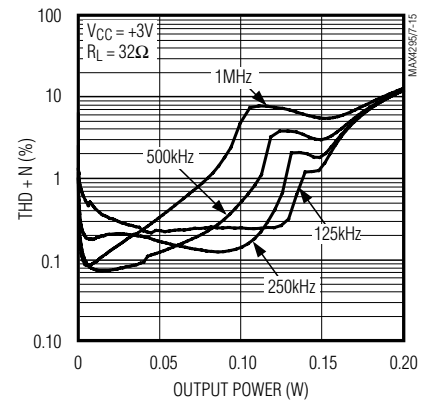

**MAX4295**  
TOTAL HARMONIC DISTORTION PLUS NOISE  
vs. OUTPUT POWER ( $f_{IN} = 20kHz$ )

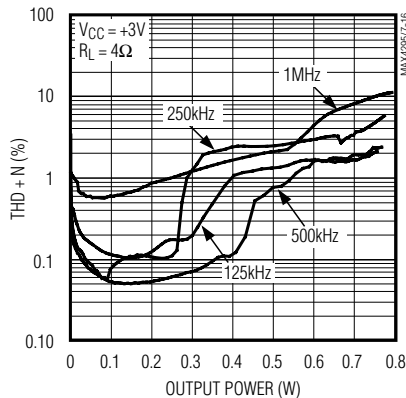

**MAX4295**  
TOTAL HARMONIC DISTORTION PLUS NOISE  
vs. OUTPUT POWER ( $f_{IN} = 20kHz$ )

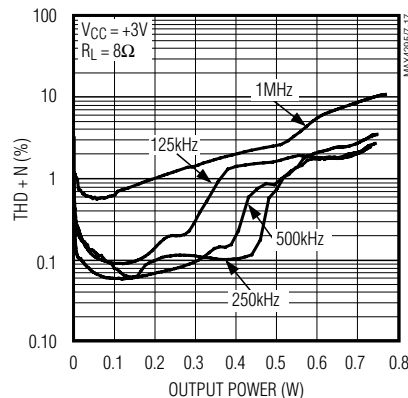

**MAX4295**  
TOTAL HARMONIC DISTORTION PLUS NOISE  
vs. OUTPUT POWER ( $f_{IN} = 20kHz$ )

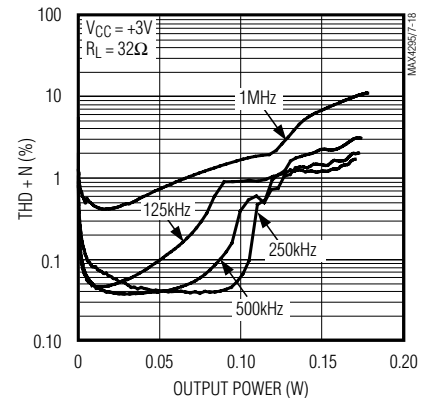

# Mono/Stereo 2W Switch-Mode (Class-D) Audio Power Amplifiers

## Typical Operating Characteristics (continued)

( $V_{CC} = PV_{CC} = +3V$ , input amplifier gain = -1,  $\overline{SHDN} = V_{CC}$ ,  $T_A = +25^\circ C$ , unless otherwise noted.)

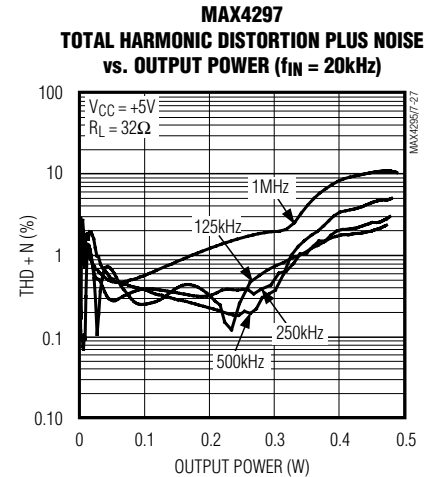
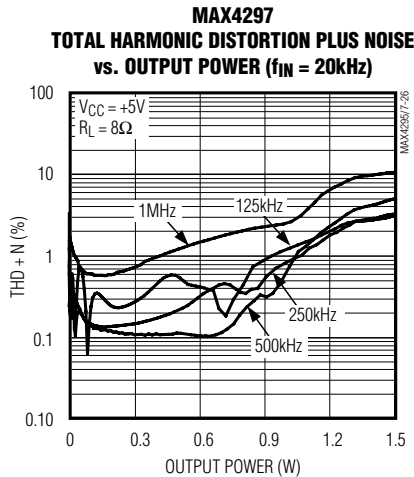
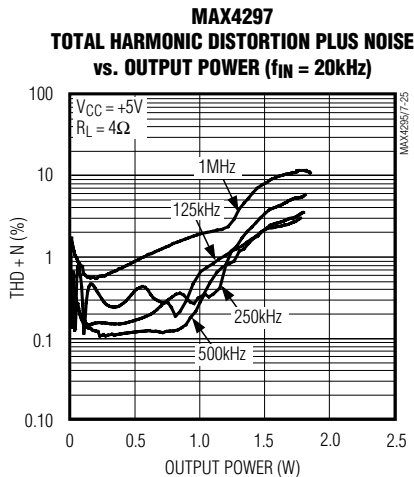
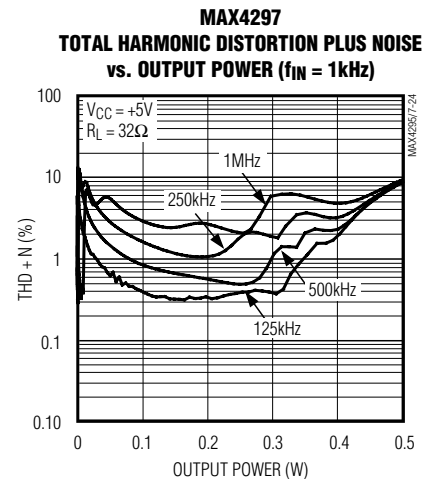
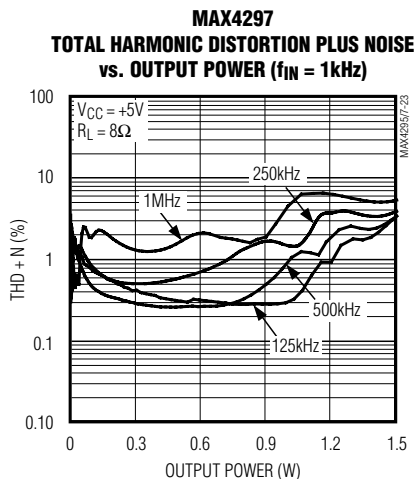
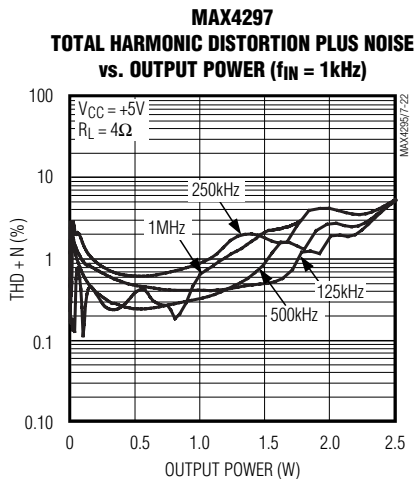
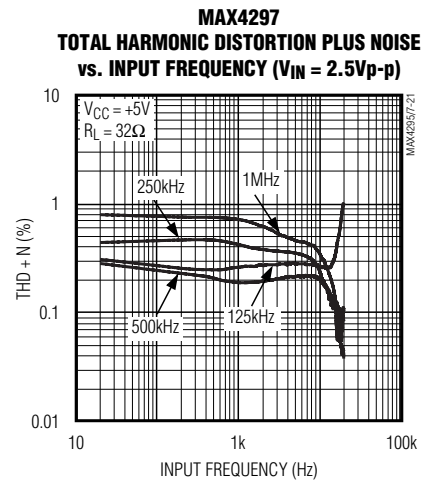
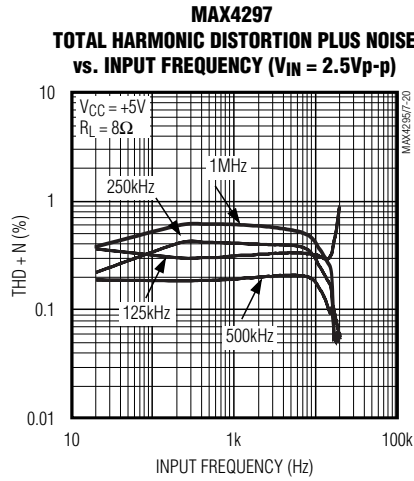
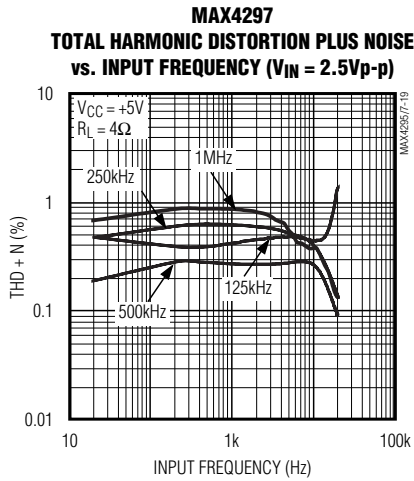

# Mono/Stereo 2W Switch-Mode (Class-D) Audio Power Amplifiers

## Typical Operating Characteristics (continued)

( $V_{CC} = PV_{CC} = +3V$ , input amplifier gain = -1,  $\overline{SHDN} = V_{CC}$ ,  $T_A = +25^\circ C$ , unless otherwise noted.)

MAX4295/MAX4297

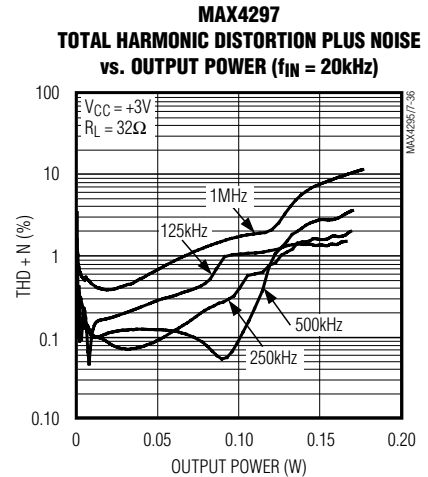
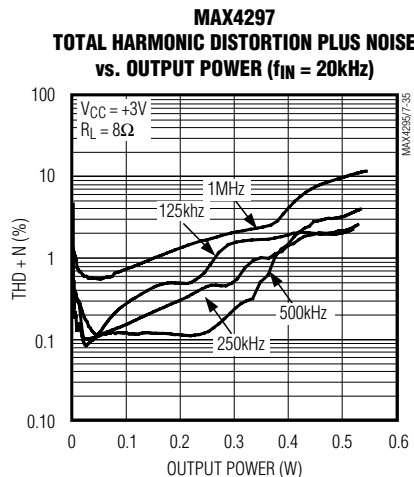
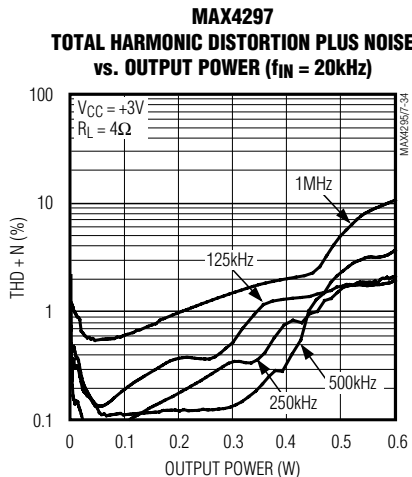
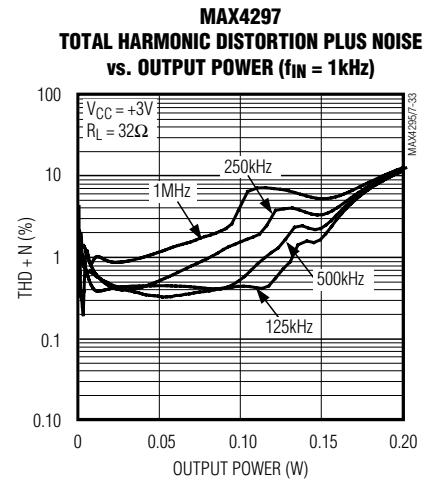
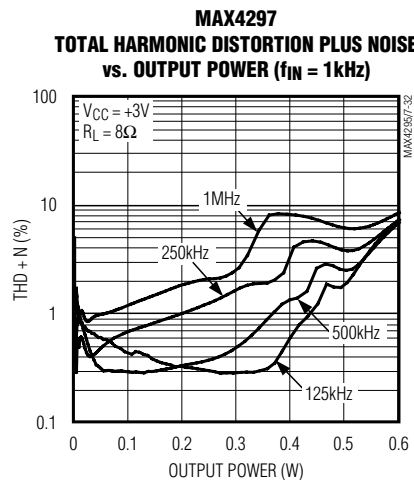
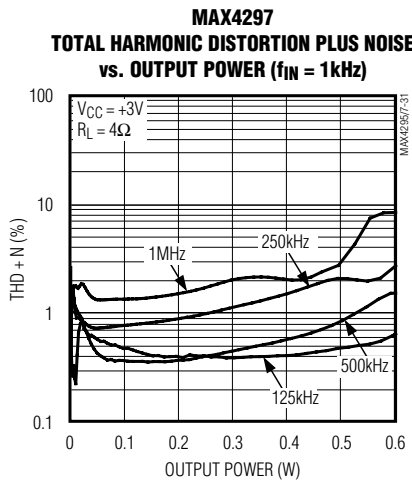
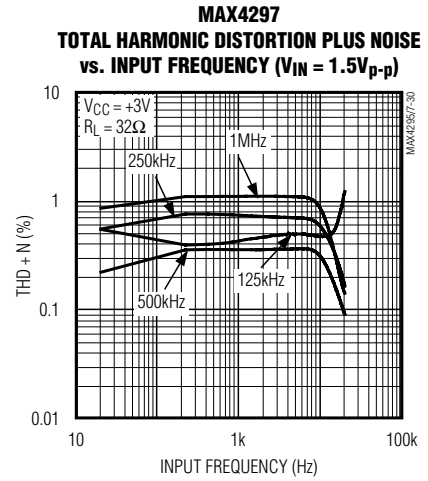
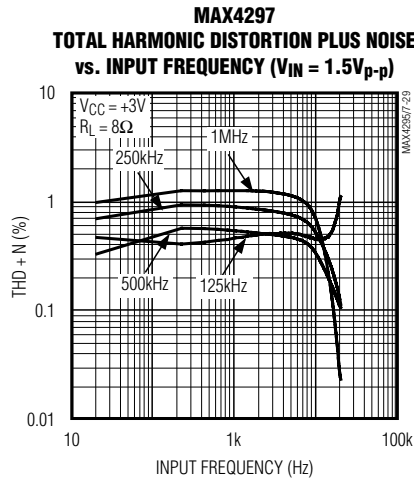
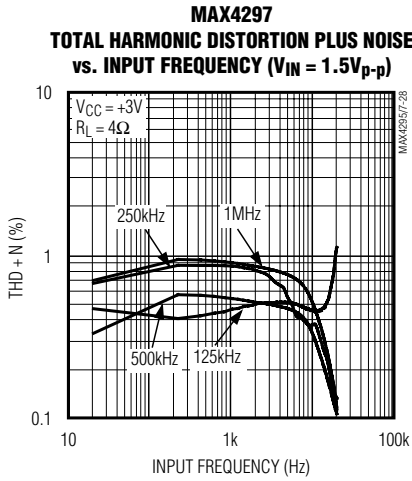



# Mono/Stereo 2W Switch-Mode (Class-D) Audio Power Amplifiers

## Typical Operating Characteristics (continued)

( $V_{CC} = PV_{CC} = +3V$ , input amplifier gain = -1,  $\overline{SHDN} = V_{CC}$ ,  $T_A = +25^\circ C$ , unless otherwise noted.)

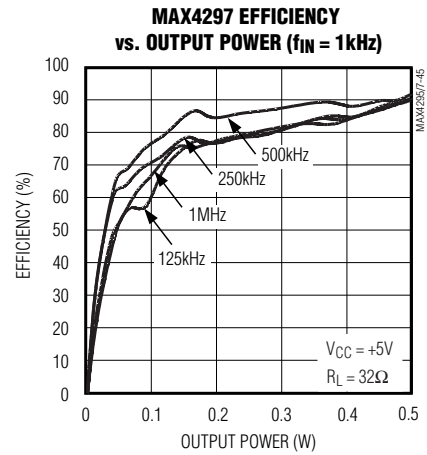
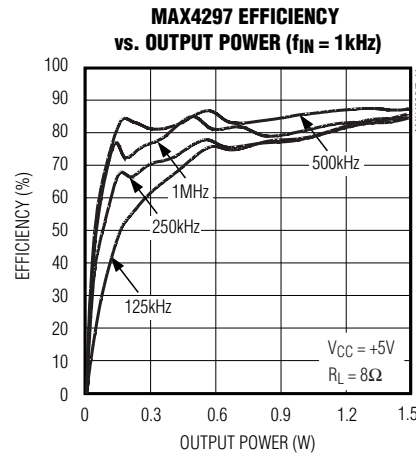
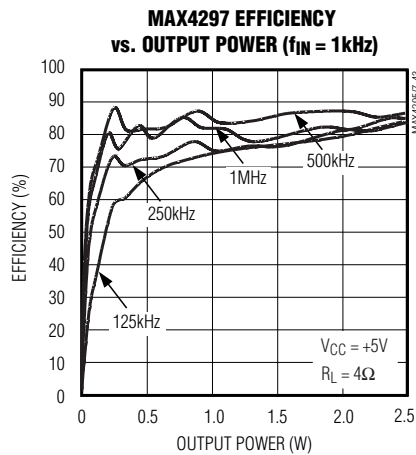
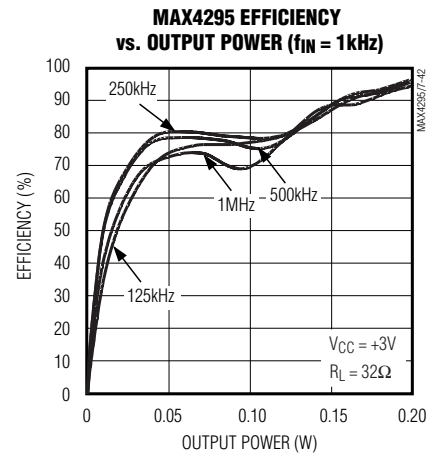
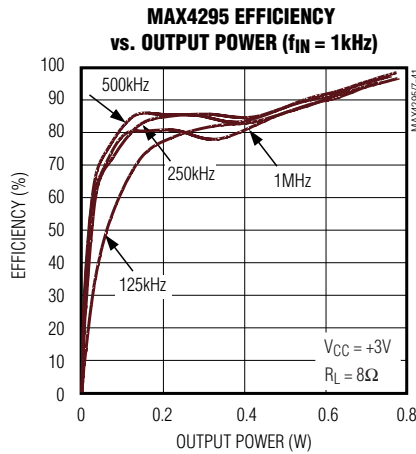
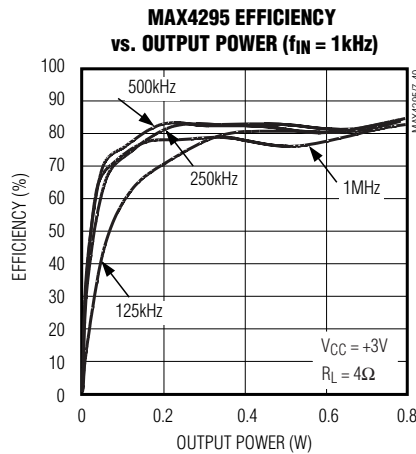
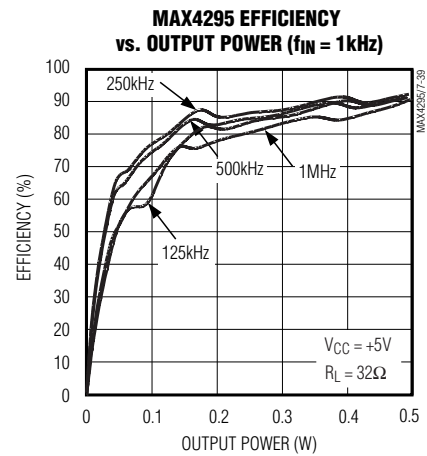
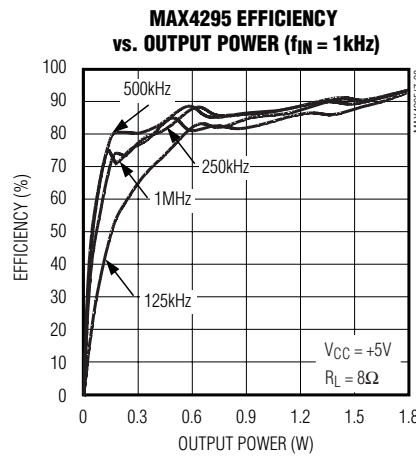
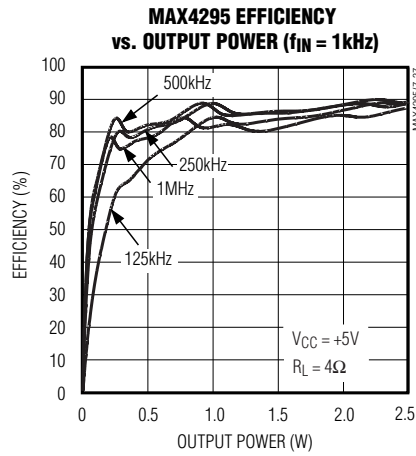

# Mono/Stereo 2W Switch-Mode (Class-D) Audio Power Amplifiers

## Typical Operating Characteristics (continued)

( $V_{CC} = PV_{CC} = +3V$ , input amplifier gain = -1,  $\overline{SHDN} = V_{CC}$ ,  $T_A = +25^\circ C$ , unless otherwise noted.)

MAX4295/MAX4297

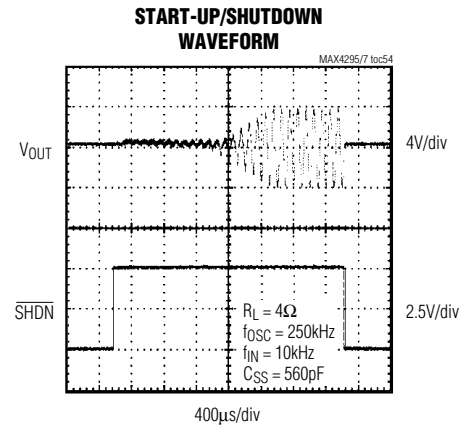
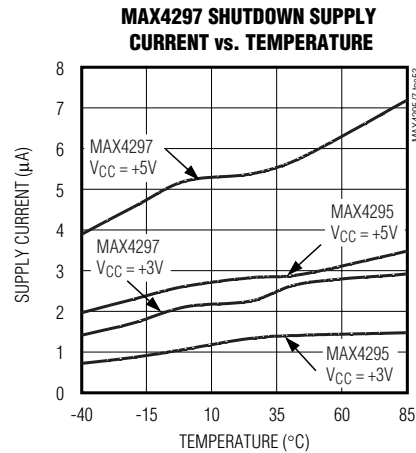
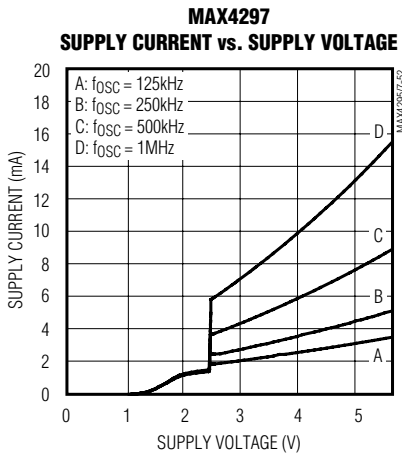
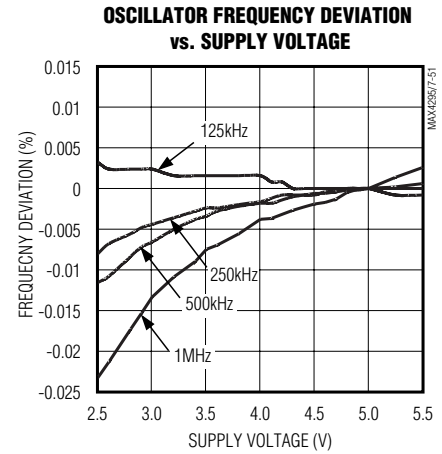
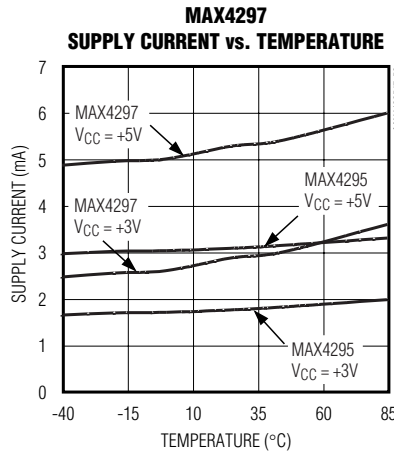
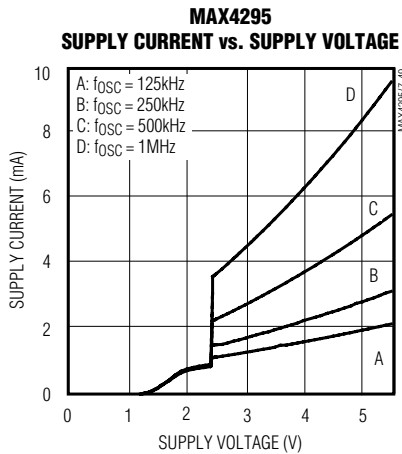
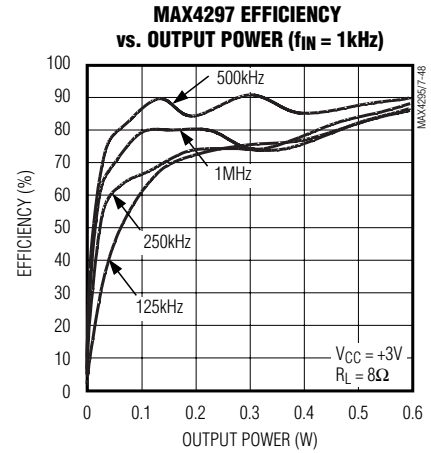
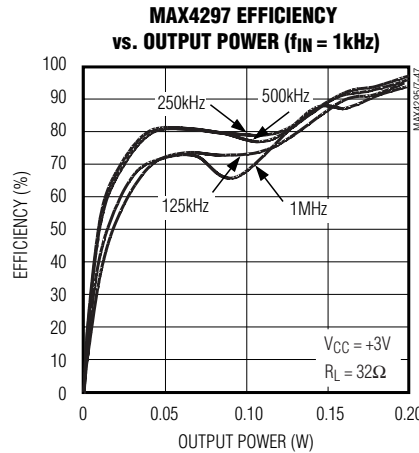
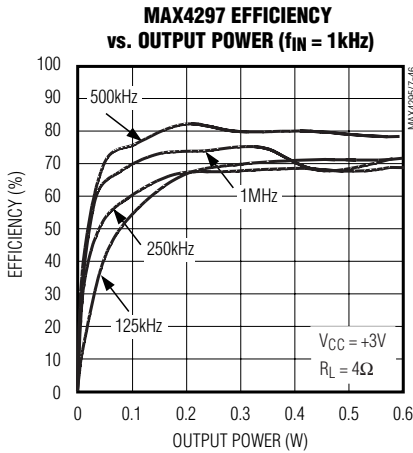

# Mono/Stereo 2W Switch-Mode (Class-D) Audio Power Amplifiers

## Pin Description

PIN		NAME	FUNCTION
MAX4295	MAX4297		
1, 12	10	GND	Analog Ground
2, 15	4, 9, 16, 21	PVCC	H-Bridge Power Supply
3	—	OUT+	Positive H-Bridge Output
—	5	OUT+L	Positive Left-Channel H-Bridge Output
—	8	OUT+R	Positive Right-Channel H-Bridge Output
4, 13	6, 7, 18, 19	PGND	Power Ground
5	3, 23	VCC	Analog Power Supply
6	13	VCM	Audio Input Common-Mode Voltage. Do not connect. Minimize parasitic coupling to this pin.
7	—	IN	Audio Input
—	2	INL	Left-Channel Audio Input
—	11	INR	Right-Channel Audio Input
8	—	AOUT	Input Amplifier Output
—	1	AOUTL	Left-Channel Input Amplifier Output
—	12	AOUTR	Right-Channel Input Amplifier Output
9	22	$\overline{\text{SHDN}}$	Active-Low Shutdown Input. Connect to VCC for normal operation. Do not leave floating.
10	14	FS1	Frequency Select Input 1
11	15	FS2	Frequency Select Input 2
14	—	OUT-	Negative H-Bridge Output
—	20	OUT-L	Negative Left-Channel H-Bridge Output
—	17	OUT-R	Negative Right-Channel H-Bridge Output
16	24	SS	Soft-Start

## Detailed Description

The MAX4295/MAX4297 switch-mode, Class-D audio power amplifiers are intended for portable multimedia and general-purpose audio applications. Linear amplifiers in the 1W to 2W output range are inefficient; they overheat when operated near rated output power levels. The efficiency of linear amplifiers is <50% when the output voltage is equal to 1/2 the supply. The MAX4295/MAX4297 Class-D amplifiers achieve efficiencies of 87% or greater and are capable of delivering up to 2W of continuous maximum power to a 4Ω load. The lost power is due mainly to the on-resistance of the power switches and ripple current in the output.

In a Class-D amplifier, a PWM controller converts the analog input to a variable pulse-width signal. The pulse width is proportional to the input voltage, ideally 0% for

a 0V input signal and 100% for full-scale input voltages. A passive lowpass LC network filters the PWM output waveform to reconstruct the analog signal. The switching frequency is selected much higher than the maximum input frequencies so that intermodulation products are outside the input signal bandwidth. Higher switching frequencies also simplify the filtering requirements.

The MAX4295/MAX4297 consist of an inverting input operational amplifier, a PWM ramp oscillator, a controller that converts the analog input to a variable pulse width signal, and a MOSFET H-bridge power stage (Figures 1a and 1b). The control signal is generated by the PWM comparator; its pulse width is proportional to the input voltage. Ideally the pulse width varies linearly between 0% for a 0V input signal and 100% for full-scale input voltages (Figure 2). This signal controls the

# Mono/Stereo 2W Switch-Mode (Class-D) Audio Power Amplifiers

MAX4295/MAX4297

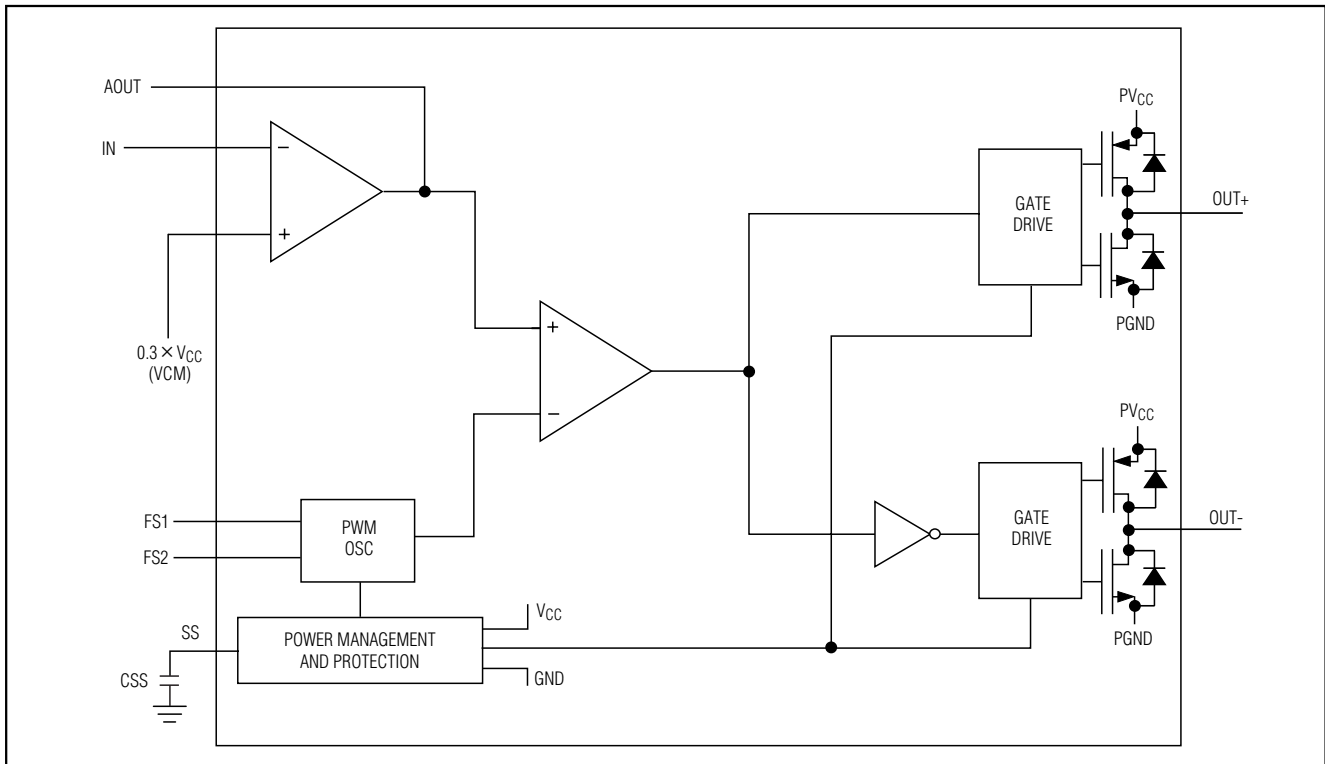

Figure 1a. MAX4295 Functional Diagram

H-bridge. The switches work in pairs to reverse the polarity of the signal in the load. Break-before-make switching of the H-bridge MOSFETs by the driver circuit keeps supply current glitches and crowbar current in the MOSFETs at a low level. The output swing of the H-bridge is a direct function of the supply voltage. Varying the oscillator swing in proportion to the supply voltage maintains constant gain with varying supply voltage.

FS1 and FS2 program the oscillator to a frequency of 125kHz, 250kHz, 500kHz, and 1MHz. The sawtooth oscillator swings between GND and  $0.6 \times V_{CC}$ . The input signal is typically AC-coupled to the internal input op amp, whose gain can be controlled through external feedback components. The common-mode voltage of the input amplifier is  $0.3 \times V_{CC}$  and is internally generated from the same resistive divider used to generate the  $0.6 \times V_{CC}$  reference for the PWM oscillator.

### Current Limit

A current-limiting circuit in the H-bridge monitors the current in the H-bridge transistors and disables the H-bridge if the current in any of the H-bridge transistors exceeds 1A. The H-bridge is enabled after a period of

100 $\mu$ s. A continuous short circuit at the output results in a pulsating output.

### Thermal Overload Protection

Thermal overload protection limits total power dissipation in the MAX4295/MAX4297. When the junction temperature exceeds +145°C, the thermal detection disables the H-bridge transistors. The H-bridge transistors are enabled after the IC's junction temperature cools by 10°C. This results in a pulsating output under continuous thermal overload conditions. Junction temperature does not exceed the thermal overload trip point in normal operation, but only in the event of fault conditions, such as when the H-bridge outputs are short circuited.

### Undervoltage Lockout

At low supply voltages, the MOSFETs in the H-bridge may have inadequate gate drive thus dissipating excessive power. The undervoltage lockout circuit prevents the device from operating at supply voltages below +2.2V.

# Mono/Stereo 2W Switch-Mode (Class-D) Audio Power Amplifiers

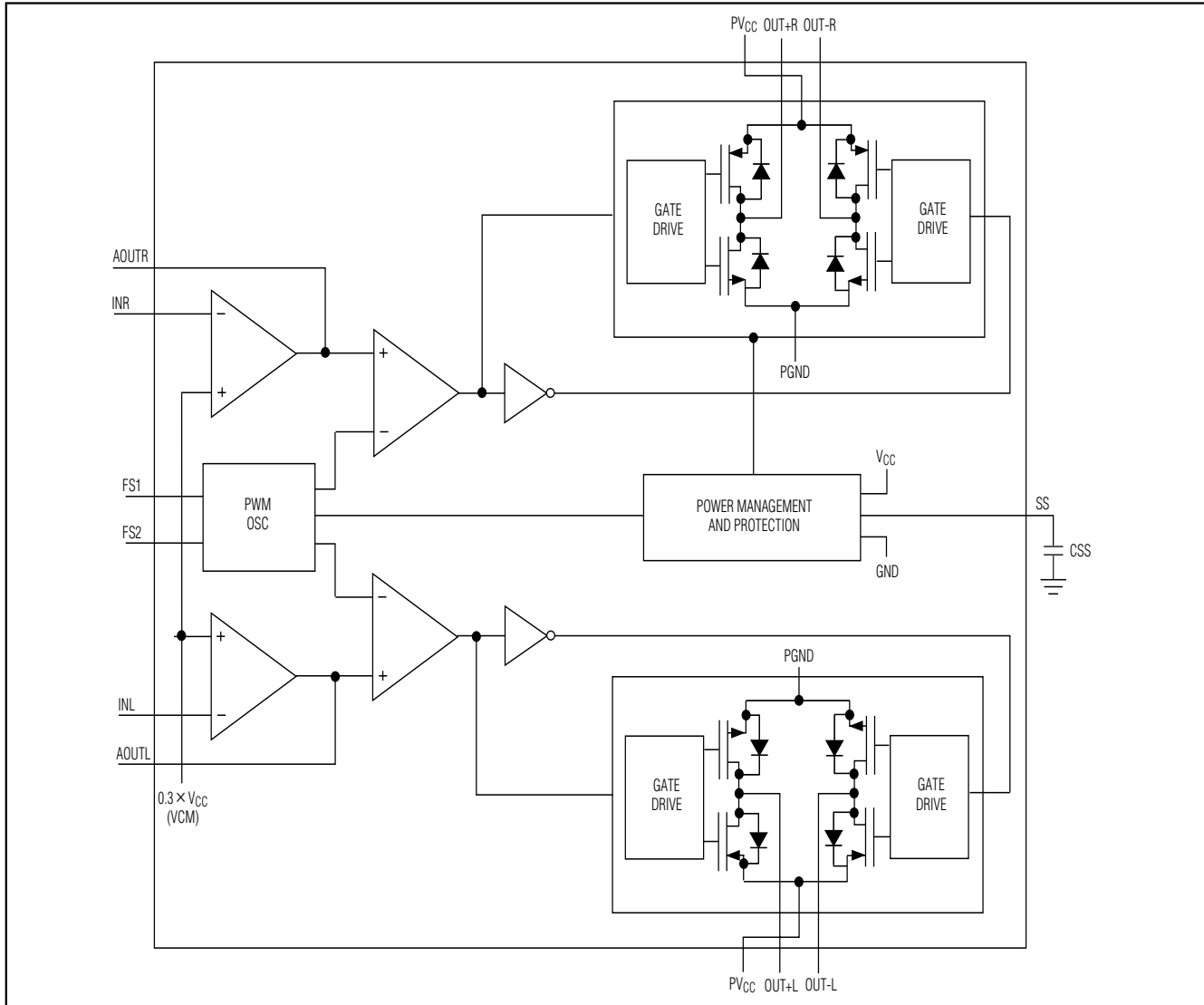

Figure 1b. MAX4297 Functional Diagram

### Low-Power Shutdown Mode

The MAX4295/MAX4297 have a shutdown mode that reduces power consumption and extends battery life. Driving  $\overline{\text{SHDN}}$  low disables the H-bridge, turns off the circuit, and places the MAX4295/MAX4297 in a low-power shutdown mode. Connect  $\overline{\text{SHDN}}$  to  $V_{CC}$  for normal operation.

## Applications Information

### Component Selection

#### Gain Setting

External feedback components set the gain of the MAX4295/MAX4297. Resistors  $R_F$  and  $R_{IN}$  set the gain of the input amplifier to  $-(R_F/R_{IN})$ . The amplifier's non-inverting input is connected to the internally generated  $0.3 \times V_{CC}$  (VCM) that sets the amplifier's common-mode voltage.

# Mono/Stereo 2W Switch-Mode (Class-D) Audio Power Amplifiers

The amplifier's input bias current is low,  $\pm 50\text{pA}$ , and does not affect the choice of feedback resistors. The noise in the circuit increases as the value of  $R_F$  increases.

The optimum impedance seen by the inverting input is between  $5\text{k}\Omega$  and  $20\text{k}\Omega$ . The effective impedance is given by  $(R_F \times R_{IN}) / (R_F + R_{IN})$ . For values of  $R_F > 50\text{k}\Omega$ , a small capacitor ( $\approx 3\text{pF}$ ) connected across  $R_F$  compensates for the pole formed by the input capacitance and the effective resistance at the inverting input.

### Soft-Start (Clickless Startup)

The H-bridge is disabled under any of the following conditions:

- SHDN low
- H-bridge current exceeds the 1A current limit
- Thermal overload
- Undervoltage lockout

The circuit re-enters normal operation if none of the above conditions are present. A soft-start function prevents an audible pop on restart. An external capacitor connected to SS is charged by an internal  $1.2\mu\text{A}$  current source and controls the soft-start rate.  $V_{SS}$  is held low while the H-bridge is disabled and allowed to ramp up to begin a soft-start. Until  $V_{SS}$  reaches  $0.3 \times V_{CC}$ , the H-bridge output is limited to a 50% duty cycle, independent of the input voltage. The H-bridge duty cycle is then gradually allowed to track the input signal at a rate determined by the ramp on SS. The soft-start cycle is complete after  $V_{SS}$  reaches  $0.6 \times V_{CC}$ .

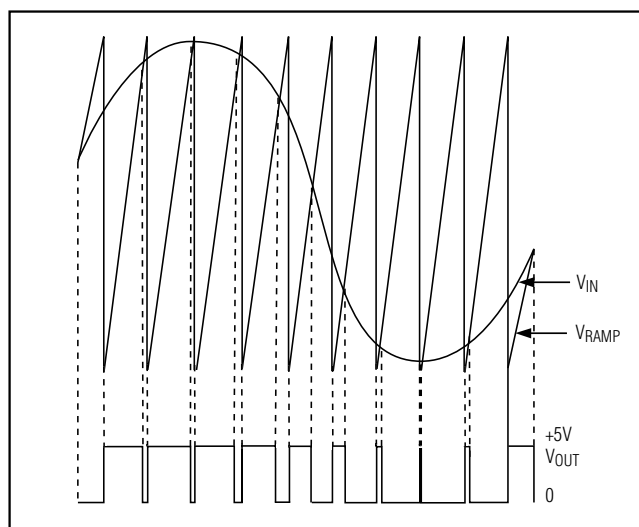

Figure 2. PWM Waveforms

### Input Filter

High-fidelity audio applications require gain flatness between 20Hz to 20kHz. Set the low-frequency cutoff point with an AC-coupling capacitor in series with the input resistor of the amplifier, creating a highpass filter (Figure 3). Assuming the input node of the amplifier is a virtual ground, the  $-3\text{dB}$  point of the highpass filter is determined by:  $f_{LO} = 1 / (2\pi \times R_{IN} \times C_{IN})$ , where  $R_{IN}$  is the input resistor, and  $C_{IN}$  is the AC-coupling capacitor. Choose  $R_{IN}$  as described in the *Gain Setting* section. Choose  $C_{IN}$  such that the corner frequency is below 20Hz.

### Frequency Selection

The MAX4295/MAX4297 have an internal logic-programmable oscillator controlled by FS1 and FS2 (Table 1). The oscillator can be programmed to frequencies of 125kHz, 250kHz, 500kHz, and 1MHz. The frequency should be chosen to best fit the application. As a rule of thumb, choose  $f_{OSC}$  to be 10 times the audio bandwidth. A lower switching frequency offers higher amplifier efficiency and lower THD but requires larger external filter components. A higher switching frequency reduces the size and cost of the filter components at the expense of THD and efficiency. In most applications, the optimal  $f_{OSC}$  is 250kHz.

Table 1. Frequency Select Logic

FS1	FS2	FREQUENCY (Hz)
0	0	125k
0	1	250k
1	0	500k
1	1	1M

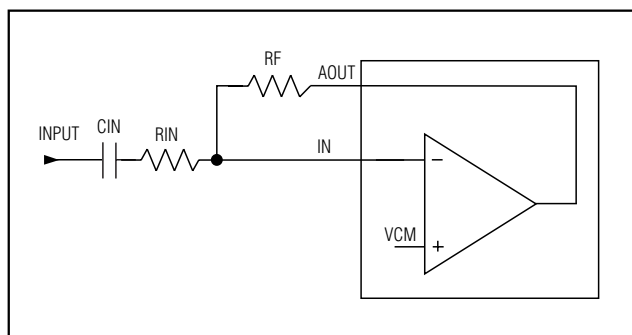

Figure 3. Input Amplifier Configuration

# Mono/Stereo 2W Switch-Mode (Class-D) Audio Power Amplifiers

## Output Filter

An output filter is required to attenuate the PWM switching frequency. Without the filter, the ripple in the load can substantially degrade efficiency and may cause interference problems with other electronic equipment.

A Butterworth lowpass filter is chosen for its flat pass band and nice phase response, though other filter implementations may also be used. Three examples are presented below. The filter parameters for balanced 2-pole (Figure 4b) and 4-pole (Figure 4d) Butterworth filters are taken from *Electronic Filter Design Handbook* by Arthur B. Williams, McGraw Hill, Inc. These filter designs assume that the load is purely resistive and load impedance is constant over frequency. Calculation of filter component values should include the DC resistance of the inductors and take into account the worst-case load scenario:

### • Single Ended 2-Pole Filter (Figure 4a)

$$C = 1 / (\sqrt{2} \times R_L \times \omega_0), L = \sqrt{2} \times R_L / \omega_0$$

where  $\omega_0 = 2 \times \pi \times f_0$  ( $f_0$  = filter cutoff frequency); choosing  $f_0 = 30\text{kHz}$  and  $R_L = 4\Omega$ ,  $C = 0.937\mu\text{F}$ ,  $L = 30\mu\text{H}$ .

A single-ended 2-pole filter uses the minimum number of external components, but the load (speaker) sees the large common-mode switching voltage, which can increase power dissipation and cause EMI problems.

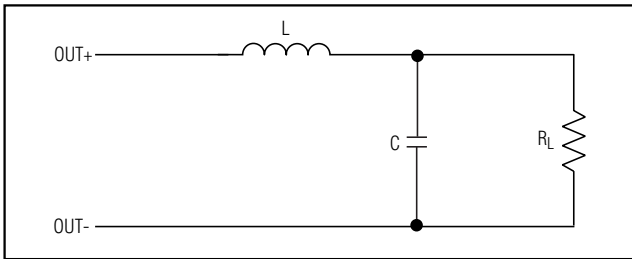

Figure 4a. Single-Ended 2-Pole Filter

### • Balanced 2-Pole (Figure 4b):

A balanced 2-Pole filter does not have the common-mode swing problem of the single-ended filter.

$C = 2 / (\sqrt{2} \times R_L \times \omega_0)$ ,  $L = (\sqrt{2} \times R_L) / (2 \times \omega_0)$ ; choosing  $f_0 = 30\text{kHz}$  and  $R_L = 4\Omega$ ,  $C1a = C1b = 2.0\mu\text{F}$ ,  $L1a = L1b = 15\mu\text{H}$ .

A single capacitor connected across  $R_L$ , with a value of  $C_L = 1 / (\sqrt{2} \times R_L \times \omega_0)$ , can be used in place of  $C1a$  and  $C1b$ . However, the configuration as shown gives an improved rejection to common-mode signal components of  $\text{OUT+}$  and  $\text{OUT-}$ . If the single capacitor scheme is used, additional capacitors ( $C_a$  and  $C_b$ ) can be added from each side of  $R_L$ , providing a high-frequency short to ground (Figure 4c). These capacitors should be approximately  $0.2 \times C_L$ .

### • Balanced 4-Pole Filter (Figure 4d)

A balanced 4-pole filter is more effective in suppressing the switching frequency and its harmonics.

For the 4-pole Butterworth filter, the normalized values are:  $L1_N = 1.5307$ ,  $L2_N = 1.0824$ ,  $C1_N = 1.5772$ ,  $C2_N = 0.3827$ .

The actual inductance and capacitance values for  $f_0 = 30\text{kHz}$  and a bridge-tied load of  $R_L = 4\Omega$  are given by:

$L1 = (L1_N \times R_L) / (2 \times \omega_0) = 16.24\mu\text{H}$ ,  $L2 = (L2_N \times R_L) / (2 \times \omega_0) = 11.5\mu\text{H}$ ,  $C1 = C1_N / (R_L \times \omega_0) = 2.1\mu\text{F}$ ,  $C2a = C2b = (2 \times C2_N) / (R_L \times \omega_0) = 1.0\mu\text{F}$ .

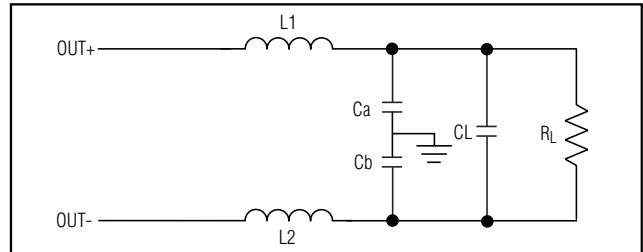

Figure 4c. Alternate Balanced 2-Pole Filter

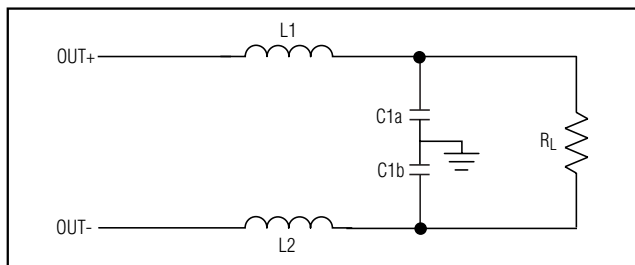

Figure 4b. Balanced 2-Pole Filter

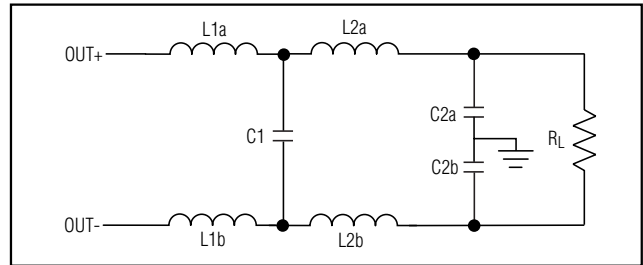

Figure 4d. Balanced 4-Pole Filter

# Mono/Stereo 2W Switch-Mode (Class-D) Audio Power Amplifiers

MAX4295/MAX4297

## Filter Components

The inductor current rating should be higher than the peak current for a given output power requirement and should have relatively constant inductance over temperature and frequency. Typically, an open-core inductor is desirable since these types of inductors are more linear. Toroidal inductors without an air gap are not recommended. Q-shielded inductors may be required if the amplifier is placed in an EMI-sensitive system. The series resistance of the inductors will reduce the attenuation of the switching frequency and reduce efficiency due to the ripple current in the inductor.

The capacitors should have a voltage rating 2 to 3 times the maximum expected RMS voltage—allowing for high peak voltages and transient spikes—and be stable over-temperature. Good quality capacitors with low equivalent series resistance (ESR) and equivalent series inductance (ESL) are necessary to achieve optimum performance. Low-ESR capacitors will decrease power dissipation. High ESL will shift the cutoff frequency, and high ESR will reduce filter rolloff.

## Bridge-Tied Load/Single-Ended Configuration

The MAX4295/MAX4297 can be used as either a BTL or single-ended configured amplifier. The BTL configuration offers several advantages over a single-ended configuration. By driving the load differentially, the output voltage swing is doubled and the output power is quadrupled in comparison to a single-ended configura-

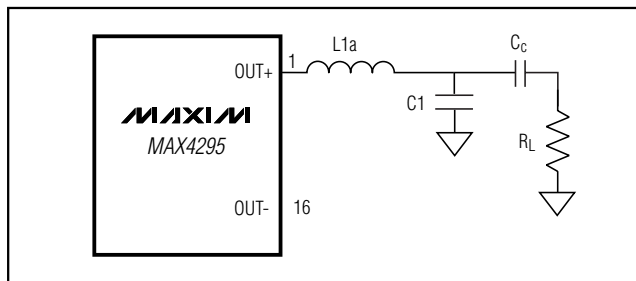

Figure 5. MAX4295 Single-Ended Configuration

tion. Because the differential outputs are biased at half supply, there is no DC voltage across the load, eliminating the need for large DC blocking capacitors at the output.

The MAX4295/MAX4297 can be configured as single-ended amplifiers. In such a case, the load must be capacitively coupled to the filter to block the half-supply DC voltage from the load. The unused output pin

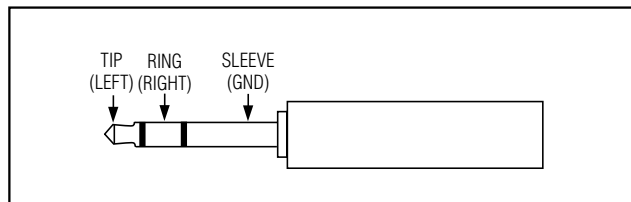

Figure 6. Typical 3-Wire Headphone Plug

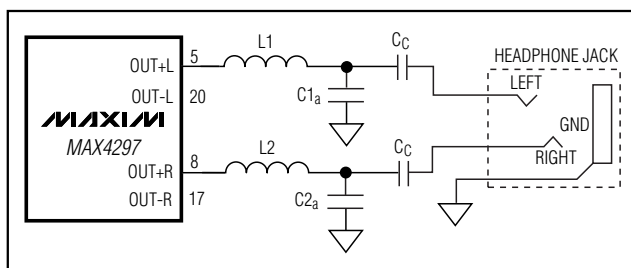

Figure 7. Headphone Application Circuit

must also be left open (Figure 5). Do not connect the unused output pin to ground.

## Headphone Applications

The MAX4295/MAX4297 can be used to drive a set of headphones. A typical 3-wire headphone plug consists of a tip, ring, and sleeve. The tip and ring are signal carriers, while the sleeve is the ground connection (Figure 6). Figure 7 shows the MAX4297 configured to drive a set of headphones. The OUT+L and OUT+R pins are connected to the tip and ring and deliver the signal to the headphone jack, while the OUT-L and OUT-R pins remain unconnected. The ground connection in the jack should be connected to the same ground plane as the output filter.

## Total Harmonic Distortion

The MAX4295/MAX4297 exhibit typical THD plus noise of <1% for input frequencies <10kHz. The PWM frequency affects THD performance. THD can be reduced by limiting the input bandwidth through the input high-pass filter, choosing the lowest  $f_{OSC}$  possible, and carefully selecting the output filter and its components.

## Bypassing and Layout Considerations

Distortion caused by supply ripple due to H-bridge switching can be reduced through proper bypassing of  $PV_{CC}$ . For optimal performance, a 330 $\mu$ F, low-ESR POSCAP capacitor to PGND and a 1 $\mu$ F ceramic capacitor to GND at each  $PV_{CC}$  input is suggested. Place the 1 $\mu$ F capacitor close to the  $PV_{CC}$  pin. Bypass  $V_{CC}$  with



# Mono/Stereo 2W Switch-Mode (Class-D) Audio Power Amplifiers

a 10µF capacitor in parallel with a 1µF capacitor to GND. Ceramic capacitors are recommended due to their low ESR.

Good PC board layout techniques optimize performance by decreasing the amount of stray capacitance at the amplifier's inputs and outputs. To decrease stray capacitance, minimize trace lengths by placing external components as close as possible to the amplifier. Surface-mount components are recommended.

The MAX4295/MAX4297 require two separate ground planes to prevent switching noise from the MOSFETs in the H-bridge from coupling into the rest of the circuit. PGND, the power ground, is utilized by the H-bridge and any external output components, while GND is used by the rest of the circuit. Connect the PGND and GND planes at only one point, as close to the power supply as possible. Any external components associated with the output of the MAX4295/MAX4297 must be connected to the PGND plane where applicable. Use the *Typical Operating Circuit* diagram as a reference.

Refer to the evaluation kit manual for suggested component values, component suppliers, and layout.

## Chip Information

TRANSISTOR COUNT: MAX4295: 846

MAX4297: 1191

PROCESS: BiCMOS

## Pin Configurations

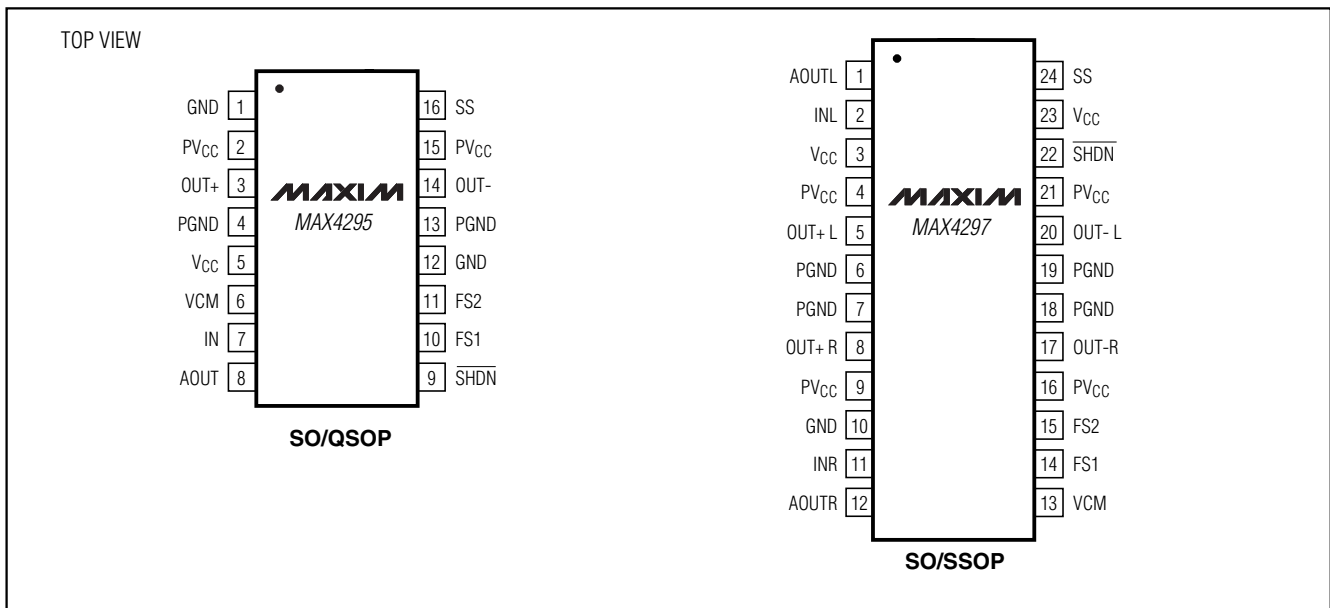

# Mono/Stereo 2W Switch-Mode (Class-D) Audio Power Amplifiers

## Package Information

MAX4295/MAX4297

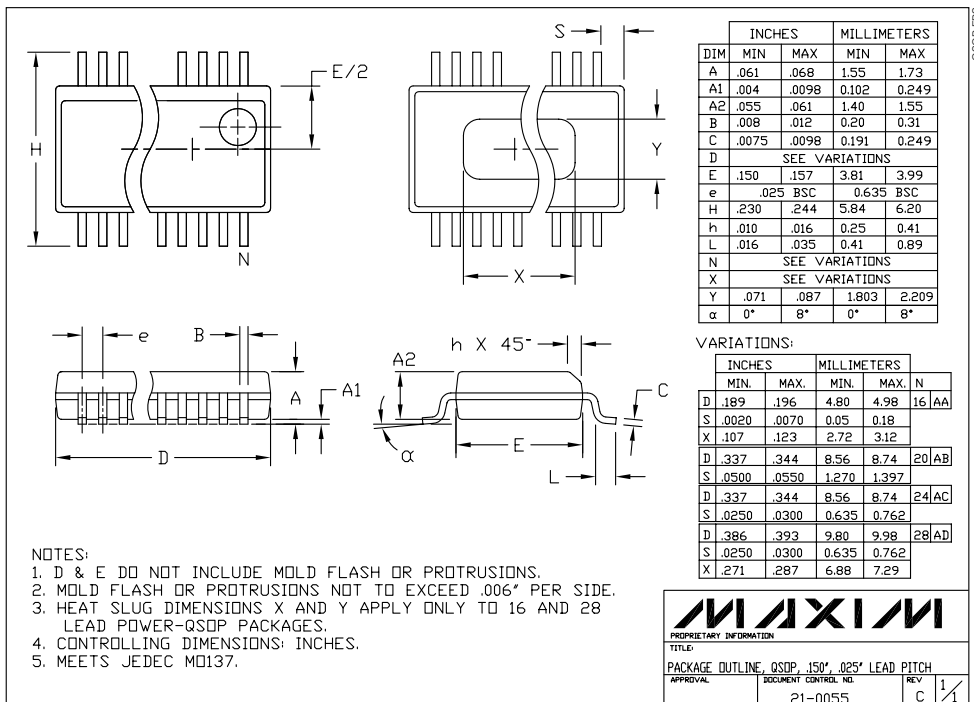
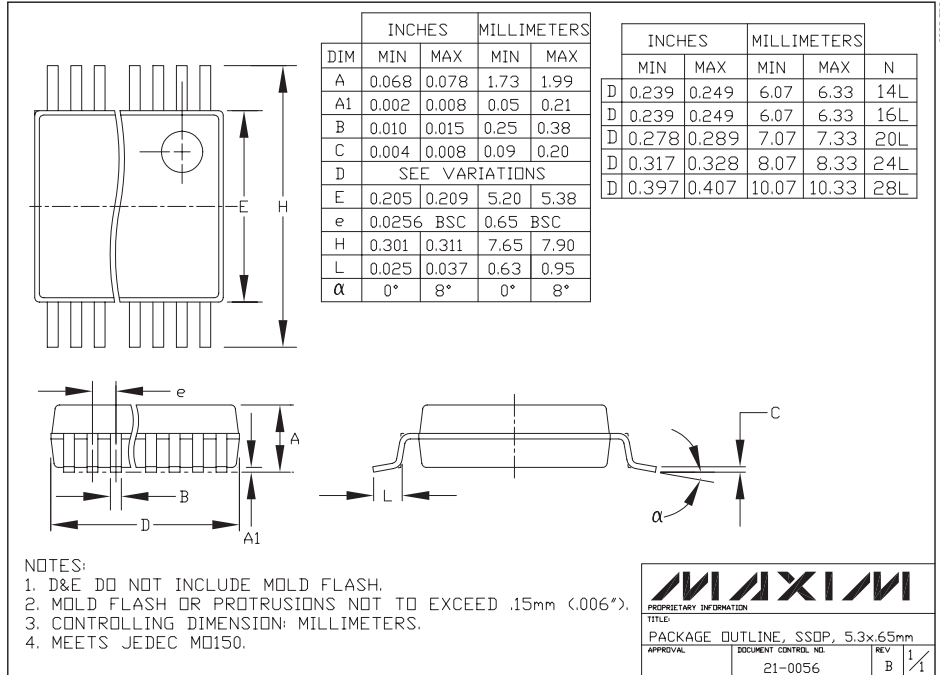

# Mono/Stereo 2W Switch-Mode (Class-D) Audio Power Amplifiers

## Package Information (continued)

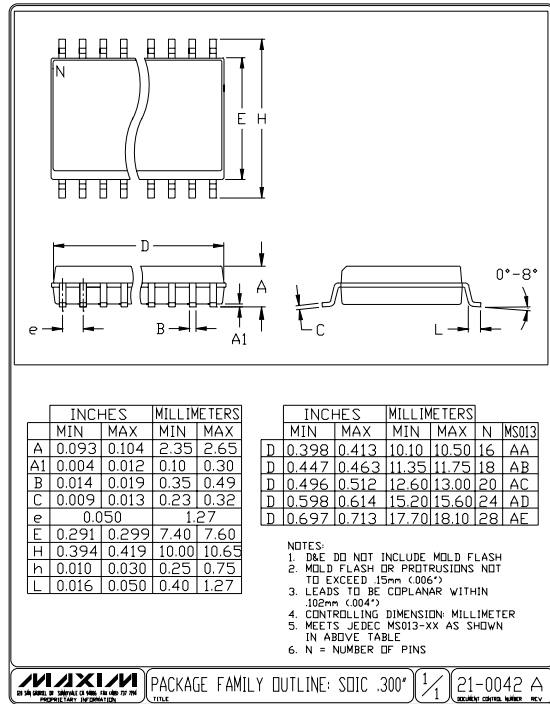
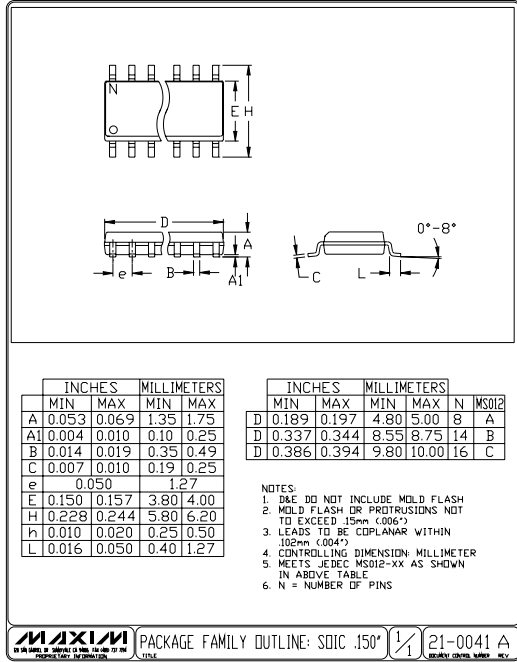

Maxim cannot assume responsibility for use of any circuitry other than circuitry entirely embodied in a Maxim product. No circuit patent licenses are implied. Maxim reserves the right to change the circuitry and specifications without notice at any time.

18 **Maxim Integrated Products, 120 San Gabriel Drive, Sunnyvale, CA 94086 408-737-7600**