



Chipsmall Limited consists of a professional team with an average of over 10 year of expertise in the distribution of electronic components. Based in Hongkong, we have already established firm and mutual-benefit business relationships with customers from,Europe,America and south Asia,supplying obsolete and hard-to-find components to meet their specific needs.

With the principle of “Quality Parts,Customers Priority,Honest Operation,and Considerate Service”,our business mainly focus on the distribution of electronic components. Line cards we deal with include Microchip,ALPS,ROHM,Xilinx,Pulse,ON,Everlight and Freescale. Main products comprise IC,Modules,Potentiometer,IC Socket,Relay,Connector.Our parts cover such applications as commercial,industrial, and automotives areas.

We are looking forward to setting up business relationship with you and hope to provide you with the best service and solution. Let us make a better world for our industry!



## Contact us

Tel: +86-755-8981 8866 Fax: +86-755-8427 6832

Email & Skype: info@chipsmall.com Web: www.chipsmall.com

Address: A1208, Overseas Decoration Building, #122 Zhenhua RD., Futian, Shenzhen, China



# MAX44005

## RGB Color, Temperature, and Infrared Proximity Sensor

### General Description

The MAX44005 integrates 7 sensors in one product: red, green, blue (RGB) sensors; an ambient light (clear) sensor; a temperature sensor; an ambient infrared sensor, and an infrared proximity sensor with an I<sup>2</sup>C interface. This highly integrated optical sensor includes a temperature sensor to improve reliability and performance.

The IC computes all the light information with parallel data converters to make simultaneous light measurement in a very short time. The chip consumes only 15μA in RGBC + IR mode and operates at 1.8V supply voltage.

The IC's RGB sensing capability improves the performance of end products by providing robust and precise information for ambient color sensing and color temperature measurement.

The integrated proximity sensor uses a single-pulse LED scheme to achieve very low power consumption. This method also improves sunlight rejection and 50Hz/60Hz noise to deliver reliable proximity measurements. With this technology, the IC is a perfect solution for touch-screen portable devices and presence detection applications.

The on-chip ambient sensor has the ability to make wide dynamic range 0.002~8388.61μW/cm<sup>2</sup> measurements. The IC's digital computation power provides programmability and flexibility for end-product design. A programmable interrupt pin minimizes the need to poll the device for data, freeing up microcontroller resources, and reducing system software overhead, and ultimately, power consumption. All these features are included in a tiny, 2mm x 2mm x 0.6mm optical package.

### Applications

Smartphones	Presence Detection
Tablet PCs	Industrial Sensors
TVs/Displays	Color Correction
Digital Light Management	

**Ordering Information** appears at end of data sheet.

### Features

- ◆ **Optical Sensor Fusion for True Color Sensing**
  - ◇ 7 Parallel ADCs
  - ◇ R, G, B, IR, ALS, Proximity Sensing
  - ◇ Temperature Sensing
- ◆ **Superior Sensitivity**
  - ◇ 0.001 Lux
- ◆ **Optimized for System Power Efficiency**
  - ◇ 10μA in Ambient Mode
  - ◇ 15μA in RGBC + IR Mode
  - ◇ 0.01μA in Shutdown Mode
- ◆ **Integrated 1-Pulse IR LED Driver for Proximity Sensing**
  - ◇ Improved Sensitivity and Power Saving
  - ◇ Sunlight Rejection
- ◆ **Digital Functionalities**
  - ◇ Programmable Channel Gains
  - ◇ Adjustable Interrupt Thresholds
- ◆ **High-Level Integration**
  - ◇ 7 Sensors in a 2mm x 2mm x 0.6mm Package

### Functional Diagram

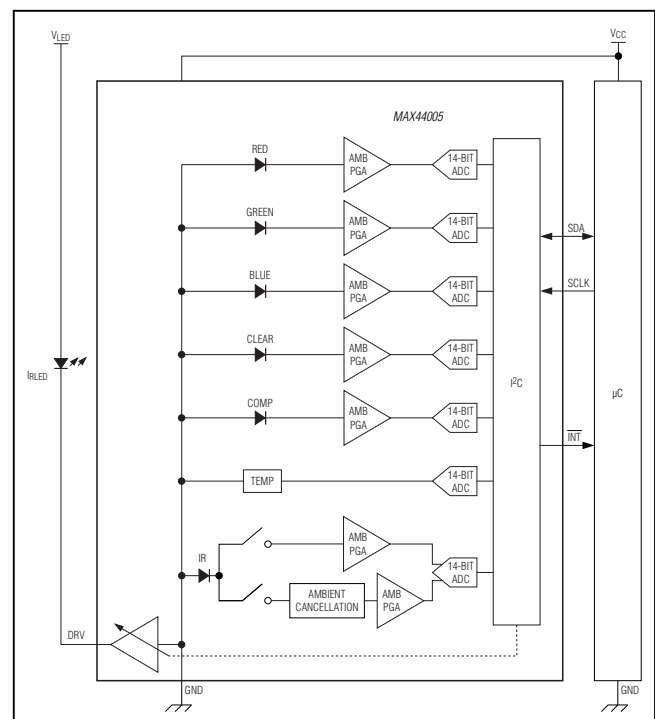

For related parts and recommended products to use with this part, refer to: [www.maximintegrated.com/MAX44005.related](http://www.maximintegrated.com/MAX44005.related)

**For pricing, delivery, and ordering information, please contact Maxim Direct at 1-888-629-4642, or visit Maxim Integrated's website at [www.maximintegrated.com](http://www.maximintegrated.com).**

# MAX44005

## RGB Color, Temperature, and Infrared Proximity Sensor

### ABSOLUTE MAXIMUM RATINGS

V <sub>CC</sub> to GND.....	-0.3V to +2.2V	Continuous Input Current into Any Terminal.....	±20mA
DRV, INT, SCL, SDA to GND .....	-0.3V to +6V	Output Short-Circuit Current Duration.....	Continuous
Continuous Power Dissipation (derate 11.9mW/°C above +70°C).....	953mW	Operating Temperature Range.....	-40°C to +85°C
		Soldering Temperature (reflow) .....	+260°C

### PACKAGE THERMAL CHARACTERISTICS (Note 1)

OTDFN

Junction-to-Ambient Thermal Resistance ( $\theta_{JA}$ ) .....	83.9°C/W
Junction-to-Case Thermal Resistance ( $\theta_{JC}$ ).....	37°C/W

**Note 1:** Package thermal resistances were obtained using the method described in JEDEC specification JESD51-7, using a four-layer board. For detailed information on package thermal considerations, refer to [www.maximintegrated.com/thermal-tutorial](http://www.maximintegrated.com/thermal-tutorial).

Stresses beyond those listed under "Absolute Maximum Ratings" may cause permanent damage to the device. These are stress ratings only, and functional operation of the device at these or any other conditions beyond those indicated in the operational sections of the specifications is not implied. Exposure to absolute maximum rating conditions for extended periods may affect device reliability.

### ELECTRICAL CHARACTERISTICS

(V<sub>CC</sub> = 1.8V, T<sub>A</sub> = +25°C, T<sub>MIN</sub>-T<sub>MAX</sub> are from -40°C to +85°C, unless otherwise noted.) (Note 2)

PARAMETER	SYMBOL	CONDITIONS	MIN	TYP	MAX	UNITS
<b>COLOR SENSOR CHARACTERISTICS</b>						
Maximum Sensitivity (Note 3)		Clear = 538nm		0.002		μW/cm <sup>2</sup>
		Red = 630nm		0.002		
		Green = 538nm		0.002		
		Blue = 470nm		0.004		
		Infrared = 850nm		0.002		
Maximum Sense Capability		Clear = 538nm		8388		μW/cm <sup>2</sup>
		Red = 630nm		8388		
		Green = 538nm		8388		
		Blue = 470nm		16,777		
		Infrared = 850nm		8388		
Total Error	TE	Power = 10μW/cm <sup>2</sup> Red = 630nm, Green = 538nm, Blue = 470nm, Clear = 538nm, IR = 850nm T <sub>A</sub> = +25°C		2	15	%
Gain Matching		Red to green to blue, T <sub>A</sub> = +25°C		0.5	10	%
Power-Up Time	t <sub>ON</sub>			10		ms
Dark Level Counts		6.25ms conversion time, 0 lux, T <sub>A</sub> = +25°C			2	Counts
ADC Conversion Time		14-bit resolution (Note 4)		400		ms

# MAX44005

## RGB Color, Temperature, and Infrared Proximity Sensor

### ELECTRICAL CHARACTERISTICS (continued)

( $V_{CC} = 1.8V$ ,  $T_A = +25^\circ C$ ,  $T_{MIN}-T_{MAX}$  are from  $-40^\circ C$  to  $+85^\circ C$ , unless otherwise noted.) (Note 2)

PARAMETER	SYMBOL	CONDITIONS	MIN	TYP	MAX	UNITS
ADC Conversion Time		14-bit resolution, $T_A = +25^\circ C$		100		ms
		12-bit resolution		25		
		10-bit resolution		6.25		
		8-bit resolution		1.5625		
ADC Conversion Accuracy		$T_A = +25^\circ C$		1	10	%
		$T_A = -40^\circ C$ to $+85^\circ C$		2	15	
<b>INFRARED PROXIMITY RECEIVER</b>						
Infrared Receiver Sensitivity		850nm IR LED		2		$\mu W/cm^2$
Maximum Infrared Receiver		850nm IR LED		16,777		$\mu W/cm^2$
ADC Conversion Time		10-bit resolution		6.25		ms
		8-bit resolution		1.5625		
Sunlight Rejection				100,000		lux
<b>INFRARED LED TRANSMITTER</b>						
Minimum IR LED Drive Current	$I_{DRV}$			10		mA
Maximum IR LED Drive Current	$I_{DRV}$			110		mA
Drive Current Accuracy		$I_{OUT} = 110mA$ , $V_{DRV} = 1.5V$			15	%
		$I_{OUT} = 50mA$ , $V_{DRV} = 1.5V$			15	
		$I_{OUT} = 10mA$ , $V_{DRV} = 1.5V$			15	
Main Voltage of DRV Pin		$I_{OUT} = 110mA$ , $\Delta I_{OUT} = 2\%$	0.5		3.6	V
Main Voltage of DRV Pin		$I_{OUT} = 100mA$ , $\Delta I_{OUT} = 5\%$	0.3		3.6	V
Burst-On/Burst-Off Ratio		AMBTIM[2:0] = 100, PRXTIM = 0, MODE[2:0] = 011		0.03		%
<b>TEMPERATURE SENSOR</b>						
Accuracy (Note 5)		$T_A = +25^\circ C \sim +55^\circ C$		$\pm 1$	$\pm 3$	$^\circ C$
		$T_A = +0^\circ C \sim +70^\circ C$		$\pm 2$	$\pm 5$	
Resolution				0.25		$^\circ C/LSB$
<b>POWER SUPPLY</b>						
Power-Supply Voltage	$V_{CC}$	Guaranteed by total error	1.7		2	V
Quiescent Current	$I_{CC}$	Clear mode		10	18	$\mu A$
		RGBC + IR mode		15	30	
		LED on		420	550	
Software Shutdown Current	$I_{SHDN}$	$T_A = +25^\circ C$			1	$\mu A$

# MAX44005

## RGB Color, Temperature, and Infrared Proximity Sensor

### ELECTRICAL CHARACTERISTICS (continued)

( $V_{CC} = 1.8V$ ,  $T_A = +25^\circ C$ ,  $T_{MIN}-T_{MAX}$  are from  $-40^\circ C$  to  $+85^\circ C$ , unless otherwise noted.) (Note 2)

PARAMETER	SYMBOL	CONDITIONS	MIN	TYP	MAX	UNITS
<b>DIGITAL CHARACTERISTICS (SDA, INT)</b>						
Output Low Voltage	$V_{OL}$	$I_{SINK} = 6mA$			0.4	V
I <sup>2</sup> C Input Voltage High	$V_{IH}$	SDA, SCL	1.4			V
I <sup>2</sup> C Input Voltage Low	$V_{IL}$	SDA, SCL			0.4	V
Input Hysteresis	$V_{HYS}$			200		mV
Input Capacitance	$C_{IN}$			10		pF
Input Leakage Current	$I_{IN}$	$V_{IN} = 0V$ , $T_A = +25^\circ C$			0.1	$\mu A$
		$V_{IN} = 5.5V$ , $T_A = +25^\circ C$			0.1	
<b>I<sup>2</sup>C TIMING CHARACTERISTICS (Note 5)</b>						
Serial-Clock Frequency	$f_{SCL}$		0		400	kHz
Bus Free Time Between STOP and START	$t_{BUF}$		1.3			$\mu s$
Hold Time (REPEATED) START Condition	$t_{HD,STA}$		0.6			$\mu s$
Low Period of the SCL Clock	$t_{LOW}$		1.3			$\mu s$
High Period of the SCL Clock	$t_{HIGH}$		0.6			$\mu s$
Setup Time for a REPEATED START	$t_{SU,STA}$		0.6			$\mu s$
Setup Time for STOP Condition	$t_{SU,STO}$		0.6			$\mu s$
Data Hold Time	$t_{HD,DAT}$		0		0.9	$\mu s$
Data Setup Time	$t_{SU,DAT}$		100			ns
Bus Capacitance	$C_B$				400	pF
SDA and SCL Receiving Rise Time	$t_R$		20 + $0.1C_B$		300	ns
SDA and SCL Receiving Fall Time	$t_F$		20 + $0.1C_B$		300	ns
SDA Transmitting Fall Time	$t_f$		20 + $0.1C_B$		250	ns
Pulse Width of Suppressed Spike	$t_{SP}$		0		50	ns

**Note 2:** 100% production tested at  $T_A = +25^\circ C$ . Specifications over temperature limits are guaranteed by bench or ATE characterization.

**Note 3:** In AMBTIM[2:0] mode (100ms integration time).

**Note 4:** At 14-bit resolution mode. Sensitivity is 4x higher with 400ms integration time than 100ms integration time.

**Note 5:** Design guidance only, not production tested.

# MAX44005

## RGB Color, Temperature, and Infrared Proximity Sensor

### Typical Operating Characteristics

( $V_{CC} = 1.8V$ ,  $T_A = +25^\circ C$ ,  $T_{MIN} - T_{MAX}$  are from  $-40^\circ C$  to  $+85^\circ C$ , unless otherwise noted.)

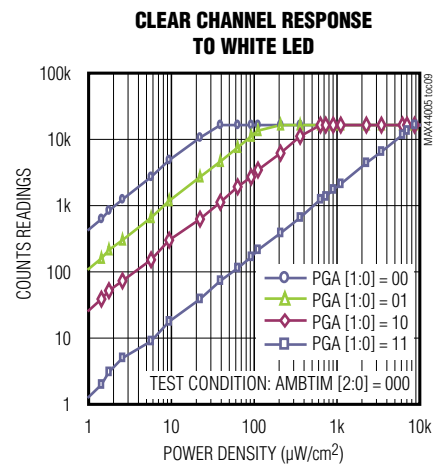
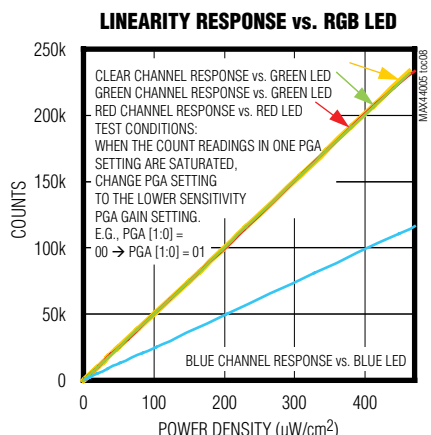
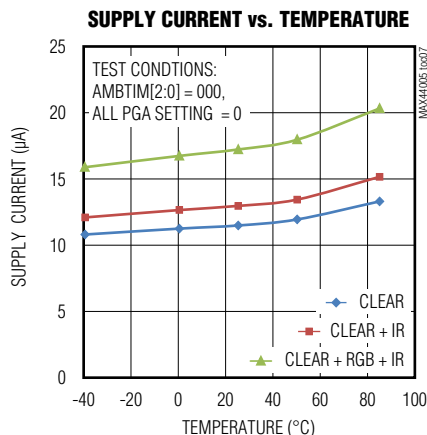
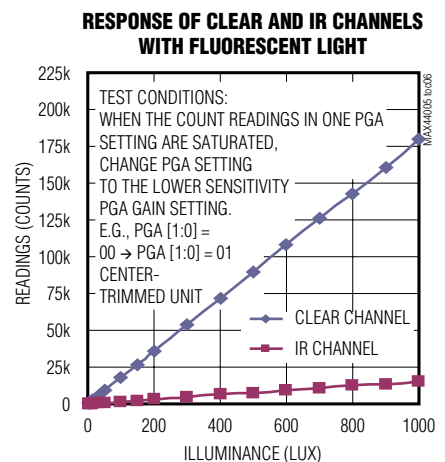
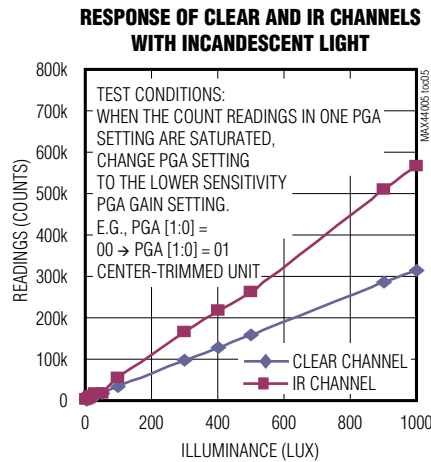
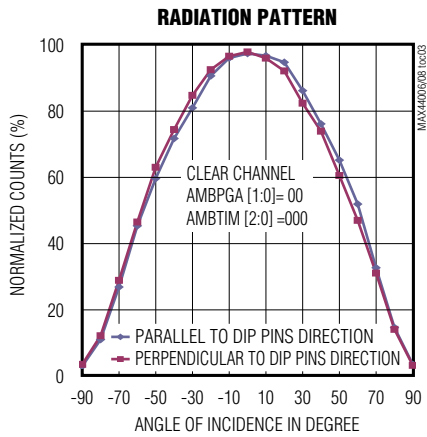
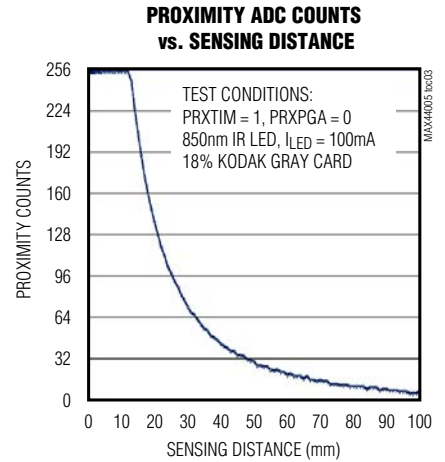
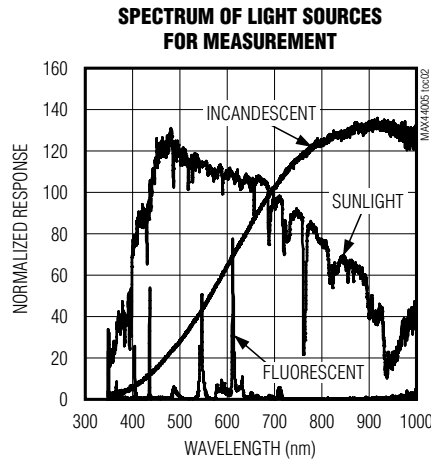
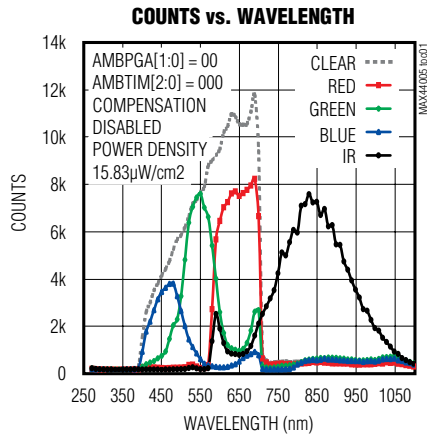

# MAX44005

## RGB Color, Temperature, and Infrared Proximity Sensor

### Typical Operating Characteristics (continued)

( $V_{CC} = 1.8V$ ,  $T_A = +25^\circ C$ ,  $T_{MIN}$ - $T_{MAX}$  are from  $-40^\circ C$  to  $+85^\circ C$ , unless otherwise noted.)

**TEMPERATURE SENSOR READINGS vs. TEMPERATURE**

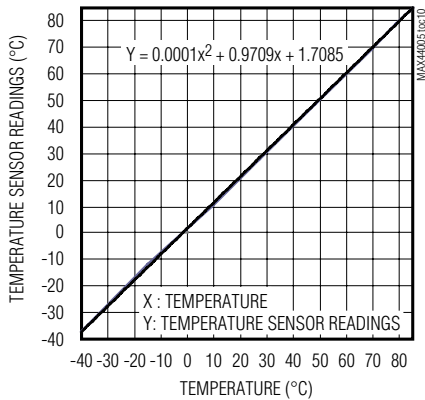

**SUPPLY CURRENT vs. LUX**

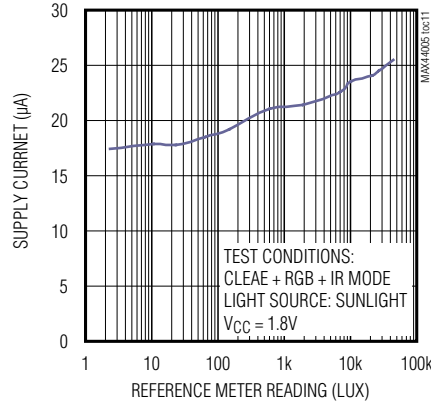

**SINK CURRENT vs.  $V_{INT}$  LOW**

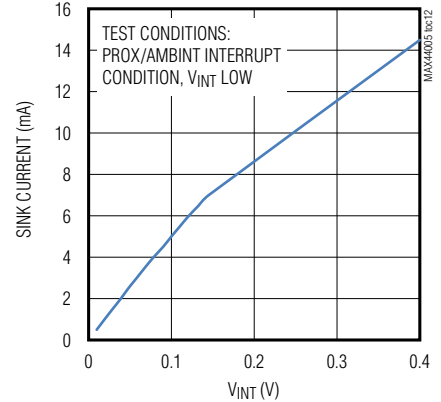

**IR LED CURRENT vs. OUTPUT DRIVE VOLTAGE,  $I_{DRV}$  vs.  $V_{DRV}$**

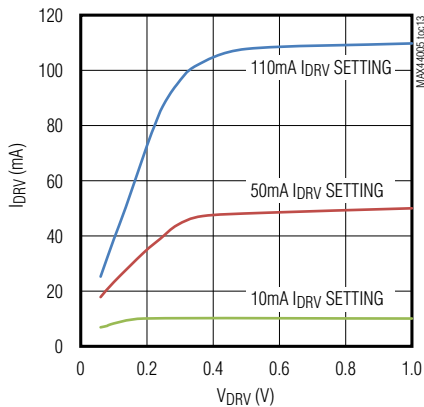

**TOTAL CURRENT CONSUMPTION vs. IR LED CURRENT LEVEL**

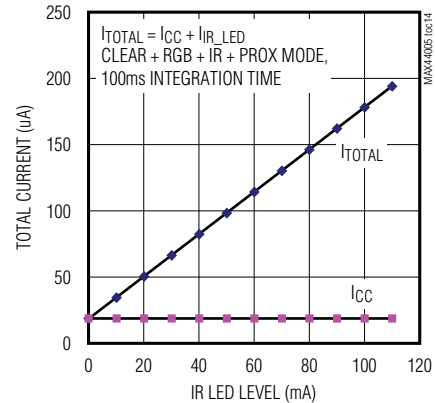

**SUPPLY CURRENT vs. TIME (ZOOM IN)**

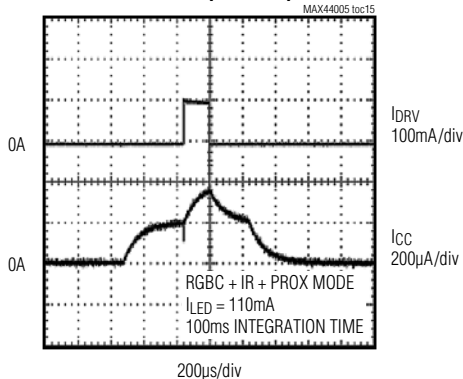

**SUPPLY CURRENT vs. TIME (ZOOM OUT)**

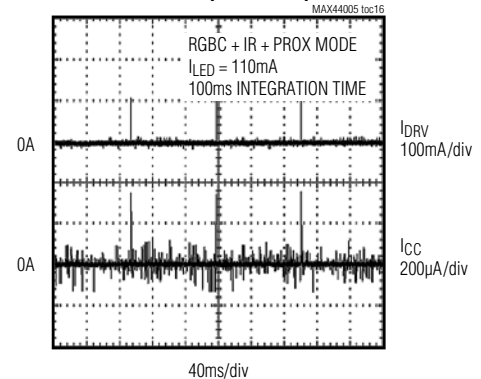

# MAX44005

## RGB Color, Temperature, and Infrared Proximity Sensor

### Typical Operating Characteristics (continued)

( $V_{CC} = 1.8V$ ,  $T_A = +25^\circ C$ ,  $T_{MIN}-T_{MAX}$  are from  $-40^\circ C$  to  $+85^\circ C$ , unless otherwise noted.)

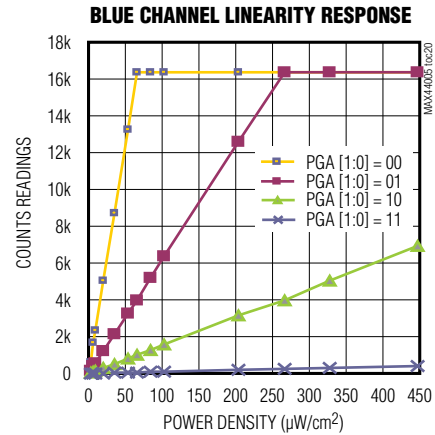
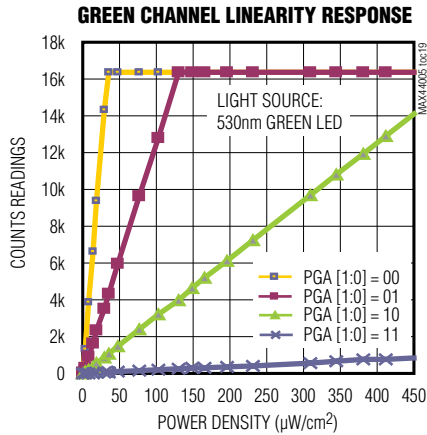
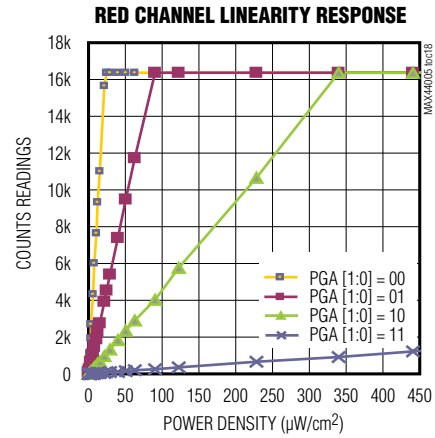
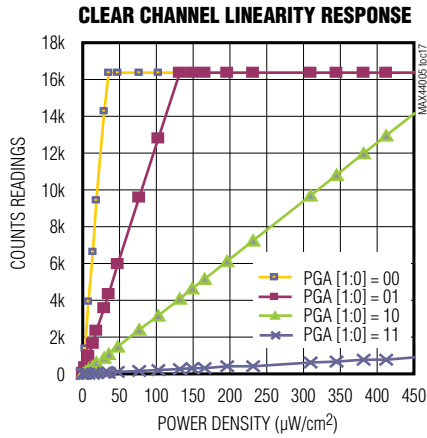



# MAX44005

## RGB Color, Temperature, and Infrared Proximity Sensor

### Pin Configuration

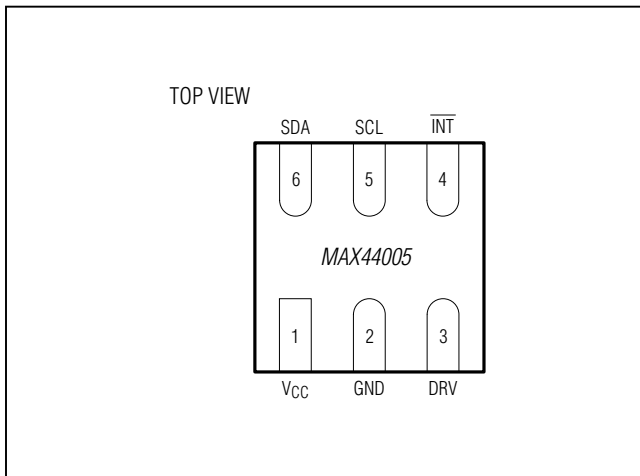

### Pin Description

PIN	NAME	FUNCTION
1	VCC	Power Supply
2	GND	Ground
3	DRV	IR LED Current Driver
4	INT	Interrupt
5	SCL	I <sup>2</sup> C Clock
6	SDA	I <sup>2</sup> C Data

### Detailed Description

The MAX44005 combines a wide-dynamic range color sensor capable of measuring red, green, and blue (RGB) and infrared content of ambient light with an integrated TEMP sensor, infrared proximity (PROX) sensor and transmitter. The IC also has a digital I<sup>2</sup>C interface and advanced interrupt pin functionality, making it very easy with which to interface. The die is placed inside an optically transparent (UTDFN-Opto) package.

A photodiode array inside the IC converts the light to a current which is then processed by low-power circuitry into a digital bit stream. The data is then stored in an output register that can be read by an I<sup>2</sup>C master.

The IC contains five types of photodiodes sensitive to red, green, blue, clear, and infrared content of ambient light.

The infrared photodiodes can be configured as either DC ambient infrared sensor or AC proximity sensor.

In the AMB mode, photodiode signals can be directly read by a sigma-delta ADC. The user can choose whether to read just the CLEAR channel, or CLEAR + IR channel or CLEAR + RGB + IR channels. Due to parallel conversion by on-chip ADCs, there is no additional delay in making ambient light information, however, there is a supply current change depending on whether only 1 channel is active (10 $\mu$ A) to whether all channels are active (15 $\mu$ A).

In the proximity detect mode, the infrared proximity photodiodes are connected to sigma-delta ADC after a sophisticated DC ambient IR rejection front-end circuit. This allows the proximity sensor to operate even in bright sunlight.

Key features of the IC include high-level integration, low-power design, small packaging, single-pulse proximity receive operation, and interrupt pin operation.

The IC operates from a V<sub>CC</sub> of 1.7V to 2V and consumes just 10 $\mu$ A current in AMB mode and 15 $\mu$ A in RGBC + IR mode. The on-chip IR proximity detector DC ambient rejection circuitry is synchronized with pulsing of an integrated IR LED transmitter to improve noise immunity from external IR sources. This scheme also reduces IR LED power consumption compared to alternate methods and eliminates red-glow problems with the use of 850nm IR LEDs. An on-chip programmable interrupt function eliminates the need to continually poll the device for data, resulting in a significant power saving.

### Ambient Light Sensing

Ambient light sensors are designed to detect brightness in the same way as human eyes do. To achieve this, the light sensor needs to have a spectral sensitivity that is identical to the photopic curve of the human eye (Figure 1).

The IC's color sensors are designed to accurately derive the color chromaticity and intensity of ambient light. With parallel ADC conversion circuits, conversion data from multiple channels can be read at the same time. An interrupt signal can also be dynamically configured with higher and lower thresholds and a persist timer. The interrupt is latched until the master reads the Interrupt Status register. This allows the master to stay in power-efficient sleep mode until a change in lighting condition alerts it.

# MAX44005

## RGB Color, Temperature, and Infrared Proximity Sensor

Variation between light sources can extend beyond the visible spectral range (e.g., fluorescent, incandescent, and sunlight) have substantially different IR radiation content. The IC incorporates on-chip measurement of RGBC and IR of compensation of ambient light, allowing accurate lux detection in a variety of lighting conditions, as well as identification of type of light source.

On-chip user-programmable Clear, RGB, Infrared Channel Gain registers allow the light sensor response to also be tailored for specific applications such as when the light sensor is placed under a colored or black glass.

### Proximity Light Sensing

The proximity sensor uses an external, infrared LED source to emit controlled amounts of radiation. When an external object reflects back some of this infrared radiation back to the IC, it is detected by the integrated sensor photodiode. The strength of reflected light is used to determine the object's proximity to the sensor.

It is important to take account for the fact that different objects at the same distance from the sensor can reflect different amounts of infrared radiation depending on their texture and color.

The IC includes on-chip ambient cancellation circuitry in the receive path of the infrared proximity sensor. This

scheme allows the part to operate in the presence of large amounts of DC-ambient IR radiation (e.g., sunlight).

In addition, the use of a single-pulse technique in pulsing the external infrared LED makes the chip immune to fixed-frequency external infrared radiation such as from remote controls, electronic ballasts, etc., and enables reliable proximity sensor operation.

### LED Driver

The IC features a LED driver that delivers a pulsed current at the output. The pulse amplitude is programmable through the I<sup>2</sup>C interface in steps of 10mA and from 0mA to 110mA. A low-voltage compliance of the DRV pin allows IR LEDs to be powered from lower voltage rails, possibly even from a 3.6V rail. High current drive accuracy improves performance by eliminating part-to-part variation. Since the duty ratio of the external IR LED is as low as 0.01%, a 100mA pulse translates to only 10µA of additional current.

### Temperature Sensor

The IC also integrates a temperature sensor that can be used for ambient temperature measurement and compensation. A nonlinear response is designed to replicate the effect of temperature on the photodiodes used on the chip.

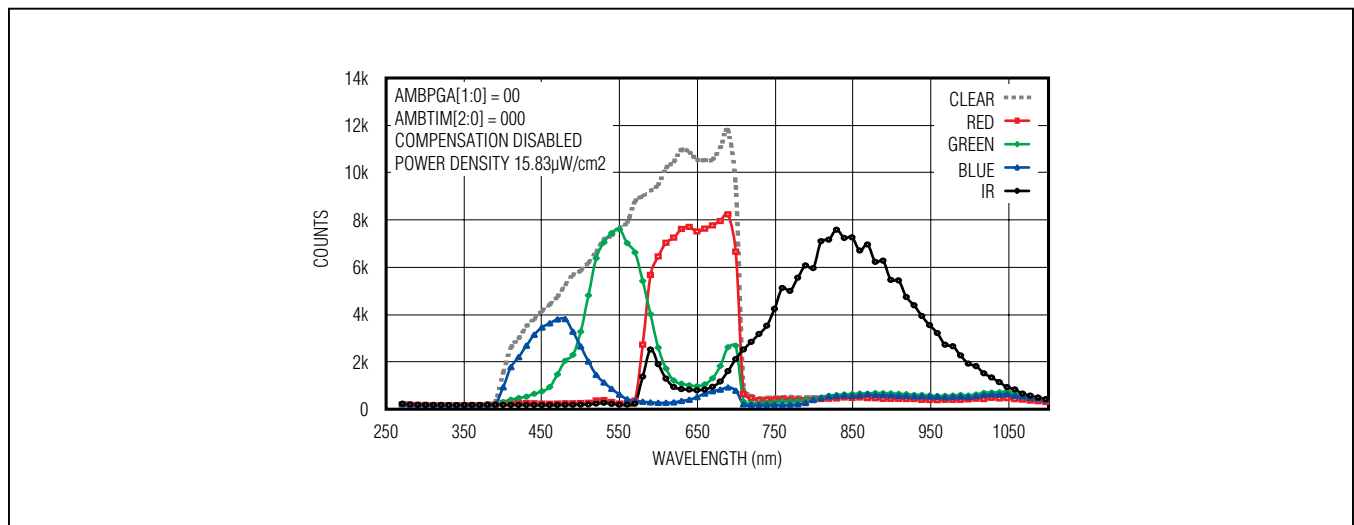

Figure 1. Wavelength vs. Counts

# MAX44005

## RGB Color, Temperature, and Infrared Proximity Sensor

### Register Description

REGISTER	B7	B6	B5	B4	B3	B2	B1	B0	REGISTER ADDRESS	POWER-ON RESET STATE	R/W
<b>STATUS</b>											
Interrupt Status				RESET	SHDN	PWRON	PRXINTS	AMBINTS	0x00	0X04	R/W
<b>CONFIGURATION</b>											
Main Configuration		MODE[2:0]			AMBSEL[1:0]		PRXINTE	AMBINTE	0x01	0x00	R/W
Ambient Configuration	TRIM	COMPEN	TEMPEN	AMBTIM[2:0]			AMBPGA[1:0]		0x02	0x20	R/W
Proximity Configuration	DRV[3:0]					PRXTIM	PRXPGA	0x03	0x02	R/W	
<b>AMBIENT + PROXIMITY READING</b>											
Ambient CLEAR High Byte			AMB_CLEAR[13:8]						0x04	0x00	R
Ambient CLEAR Low Byte	AMB_CLEAR[7:0]								0x05	0x00	R
Ambient RED High Byte			AMB_RED[13:8]						0x06	0x00	R
Ambient RED Low Byte	AMB_RED[7:0]								0x07	0x00	R
Ambient GREEN High Byte			AMB_GREEN[13:8]						0x08	0x00	R
Ambient GREEN Low Byte	AMB_GREEN[7:0]								0x09	0x00	R
Ambient BLUE High Byte			AMB_BLUE[13:8]						0x0A	0x00	R
Ambient BLUE Low Byte	AMB_BLUE[7:0]								0x0B	0x00	R
Ambient INFRARED High Byte			AMB_IR[13:8]						0x0C	0x00	R
Ambient INFRARED Low Byte	AMB_IR[7:0]								0x0D	0x00	R
Ambient IR COMP High Byte			AMB_IRCOMP[13:8]						0x0E	0x00	R
Ambient IR COMP Low Byte	AMB_IRCOMP[7:0]								0x0F	0x00	R
PROXIMITY IR High Byte							PROX[9:8]	0x10	0x00	R	
PROXIMITY IR Low Byte	PROX[7:0]								0x11	0x00	R
<b>TEMPERATURE SENSOR</b>											
TEMP High Byte			TEMP[13:8]						0x12	0x00	R
TEMP Low Byte	TEMP[7:0]								0x13	0x00	R
<b>INTERRUPT THRESHOLDS</b>											
AMB Upper Threshold—High Byte			UPTHR[13:8]						0x14	0x00	R/W
AMB Upper Threshold—Low Byte	UPTHR[7:0]								0x15	0x00	R/W
AMB Lower Threshold—High Byte			LOTHR[13:8]						0x16	0x00	R/W
AMB Lower Threshold—Low Byte	LOTHR[7:0]								0x17	0x00	R/W
Threshold Persist Timer					PRXPST[1:0]		AMBPST[1:0]		0x18	0x00	R/W
PROX Upper Threshold—High Byte							PRXUPTHR[9:8]	0x19	0xFF	R/W	
PROX Upper Threshold—Low Byte	PRXUPTHR[7:0]								0x1A	0xFF	R/W
PROX Lower Threshold—High Byte							PRXLOTHR[9:8]	0x1B	0x00	R/W	
PROX Lower Threshold—Low Byte	PRXLOTHR[7:0]								0x1C	0x00	R/W
<b>AMBIENT ADC GAINS</b>											
Digital Gain Trim of Clear Channel		TRIM_GAIN_CLEAR[6:0]						0x1D	0xFF	R/W	
Digital Gain Trim of Red Channel		TRIM_GAIN_RED[6:0]						0x1E	0xFF	R/W	
Digital Gain Trim of Green Channel		TRIM_GAIN_GREEN[6:0]						0x1F	0xFF	R/W	
Digital Gain Trim of Blue Channel		TRIM_GAIN_BLUE[6:0]						0x20	0xFF	R/W	
Digital Gain Trim of Infrared Channel		TRIM_GAIN_IR[6:0]						0x21	0xFF	R/W	

# MAX44005

## RGB Color, Temperature, and Infrared Proximity Sensor

The individual register bits are explained below.

### Interrupt Status (0x00)

REGISTER	BIT7	BIT6	BIT5	BIT4	BIT3	BIT2	BIT1	BIT0	REGISTER ADDRESS	POWER-ON RESET STATE	R/W
Interrupt Status				RESET	SHDN	PWRON	PRXINTS	AMBINTS	0x00	0x04	R/W

The AMBINTS bit in the Status register 0x00 is read only and indicates that an ambient light interrupt condition has occurred. If any of these bits (PWRON, PRXINTS, AMBINTS) is set to 1, the  $\overline{\text{INT}}$  pin is pulled low. The PRXINTS bit in the Status register 0x00 is read only and indicates that a proximity receive interrupt condition has occurred. PWRON bit in the Status register 0x00 is read only, and if set, indicates that a power-on-reset condition has occurred, and any user-programmed thresholds may not be valid anymore. The SHDN bit in the Status register 0x00 is read/write and can be used to put the part into and bring out of shutdown for power saving. All register data is retained during this operation. The RESET bit in the Status register 0x00 is also read/write and can be used to reset all of the registers back to power-on default condition.

Reading the Interrupt Status register clears the PWRON, PRXINTS and AMBINTS bits, and if set, deasserts the  $\overline{\text{INT}}$  pin ( $\overline{\text{INT}}$  pin is pulled high by the off-chip pullup resistor). The PRXINTS and AMBINTS bits are disabled and set to 0 if the respective interrupt enable bits in Register 0x01 are set to 0.

**Table 1. Ambient Interrupt Status Flag (AMBINTS)**

BIT0	OPERATION
0	No interrupt trigger event has occurred.
1	The ambient light has exceeded the designated window limits defined by threshold registers for longer than persist timer count AMBPST[1:0]. It also causes the $\overline{\text{INT}}$ pin to be pulled low. Once set, the only way to clear this bit is to read this register. This bit is always set to 0 if AMBINTEN bit is set to 0.

**Table 2. Proximity Receive Interrupt Status Flag (PRXINTS)**

BIT1	OPERATION
0	No interrupt trigger event has occurred.
1	The IR proximity receive intensity has exceeded the proximity threshold limit for longer than persist timer count PRXPST[1:0]. It also causes the $\overline{\text{INT}}$ pin to be pulled low. Once set, the only way to clear this bit is to read this register. This bit is always set to 0 if PRXINTEN bit is set to 0.

**Table 3. Power-On Interrupt Status Flag (PWRON)**

BIT2	OPERATION
0	Normal operating mode.
1	The part went through a power-up event, either because the part was turned on or because there was a power-supply voltage glitch. All interrupt threshold settings in the registers have been reset to power-on-default states and should be examined if necessary. The $\overline{\text{INT}}$ pin is also pulled low. Once this bit is set, the only way to clear this bit is to read this register.

# MAX44005

## RGB Color, Temperature, and Infrared Proximity Sensor

**Table 4. Shutdown Control (SHDN)**

BIT3	OPERATION
0	The part is in normal operation. When the part returns from shutdown, note that the value in the data registers is not current until first conversion cycle is completed.
1	The part can be put into a power-save mode by writing a 1 to this bit. Supply current is reduced to about 0.05μA with no I <sup>2</sup> C clock activity. While all registers remain accessible and retain data, ADC conversion data contained in them may not be current. Writeable registers also remain accessible in shutdown. All interrupts are cleared.

**Table 5. Reset Control (RESET)**

BIT4	OPERATION
0	The part is in normal operation.
1	The part undergoes a forced power-on-reset sequence. All Configuration, Threshold, and Data registers are reset to power-on state by writing a 1 to this bit, and an internal hardware reset pulse is generated. This bit then automatically becomes 0 after the RESET sequence is completed. After resetting, the PWRON interrupt is triggered.

### Main Configuration (0x01)

REGISTER	BIT7	BIT6	BIT5	BIT4	BIT3	BIT2	BIT1	BIT0	REGISTER ADDRESS	POWER-ON RESET STATE	R/W	
Main Configuration			MODE[2:0]			AMBSEL[1:0]		PRXINTE	AMBINTE	0x01	0x20	R/W

Writing to the Main Configuration register does not abort any ambient or proximity data conversion (Registers 0x04 to 0x11) if already in progress. It applies the new settings during the next conversion period.

**Table 6. Ambient Interrupt Enable (AMBINTE)**

BIT0	OPERATION
0	The AMBINTS bit and $\overline{INT}$ pin remain unasserted even if an ambient interrupt event has occurred. The AMBINTS bit is set to 0 if previously set to 1. See Table 1 for more details.
1	Detection of ambient interrupt events is enabled. See Table 1 for more details. An ambient interrupt can trigger a hardware interrupt ( $\overline{INT}$ pin pulled low) and set the AMBINTS bit (Register 0x00, BIT0).

**Table 7. Proximity Interrupt Enable (PRXINTE)**

BIT1	OPERATION
0	PRXINTS bit and $\overline{INT}$ pin remains unasserted even if a proximity interrupt event has occurred. The PRXINTS bit is set to 0 if previously set to 1. See Table 2 for more details.
1	Detection of proximity interrupt events is enabled. See Table 2 for more details. A proximity interrupt can trigger a hardware interrupt ( $\overline{INT}$ pin pulled low) and set the PRXINTS bit (Register 0x00, BIT1).

**Note:** Detection of ambient interrupt event sets the AMBINTS bit (Register 0x00, BIT0) only if AMBINTE bit is set to 1. Detection of a proximity interrupt event sets the PRXINTS bit (Register 0x00, BIT1) only if PRXINTE bit is set to 1. If either AMBINTS or PRXINTS bits are set to 1, it pulls the interrupt  $\overline{INT}$  pin low (assert it). A read of the Interrupt Status register clears both the AMBINTS and PRXINTS bits if set to 1, and deassert the  $\overline{INT}$  pin if pulled low.

# MAX44005

## RGB Color, Temperature, and Infrared Proximity Sensor

### Ambient Interrupt Select (AMBSEL[1:0])

The two AMBSEL[1:0] bits define four operating modes for the IC.

**Table 8. Ambient Interrupt Select (AMBSEL[1:0])**

AMBSEL[1:0]	OPERATION
00	CLEAR channel data is used to compare with ambient interrupt thresholds and ambient timer settings.
01	GREEN channel data is used to compare with ambient interrupt thresholds and ambient timer settings.
10	IR channel data is used to compare with ambient interrupt thresholds and ambient timer settings.
11	TEMP channel data is used to compare with ambient interrupt thresholds and ambient timer settings.

### MODE[2:0]

The three MODE[2:0] bits define eight operating modes for the IC.

**Table 9. MODE[2:0]**

MODE[2:0]	OPERATING MODE	COMMENTS
000	CLEAR	CLEAR + TEMP* channel active only
001	CLEAR + IR	CLEAR + TEMP* + IR channels active
010	CLEAR + RGB + IR	CLEAR + TEMP* + RGB + IR channels active
011	CLEAR + IR + PROX	CLEAR + TEMP* + IR + PROX channels active (CLEAR + TEMP* + IR + PROX interleaved)
100	CLEAR + RGB + IR + PROX	CLEAR + TEMP* + RGB + IR + PROX channels active (CLEAR + TEMP* + RGB + IR and PROX interleaved)
101	PROX only	PROX only continuous
110	Reserved	Reserved
111	Reserved	Reserved

\*When TEMPEN is set to 1.

### Ambient Configuration Register (0x02)

REGISTER	BIT7	BIT6	BIT5	BIT4	BIT3	BIT2	BIT1	BIT0	REGISTER ADDRESS	POWER-ON RESET STATE	R/W
Ambient Configuration	TRIM	COMPEN	TEMPEN	AMBTIM[2:0]		AMBPGA[1:0]			0x02	0x00	R/W

Writing to the Ambient Configuration register aborts any ambient data conversion (Registers 0x04 to 0x0F) if already in progress, applies the new settings immediately, and initiates a new conversion.

# MAX44005

## RGB Color, Temperature, and Infrared Proximity Sensor

**AMBPGA[1:0]**

The two AMBPGA[1:0] bits set the gain of the clear/red/green/blue/IR channel measurements according to Table 10.

**Table 10. AMBPGA[1:0]**

In AMBTIM[2:0] = 000 mode (100ms integration time).

AMBPGA[1:0]	CLEAR		RED		GREEN	
	nW/cm <sup>2</sup> per LSB*	FULL SCALE (μW/cm <sup>2</sup> )	nW/cm <sup>2</sup> per LSB*	FULL SCALE (μW/cm <sup>2</sup> )	nW/cm <sup>2</sup> per LSB*	FULL SCALE (μW/cm <sup>2</sup> )
00	2	32.768	2	32.768	2	32.768
01	8	131.072	8	131.072	8	131.072
10	32	524.288	32	524.288	32	524.288
11	512	8388.61	512	8388.61	512	8388.61
AMBPGA[1:0]	BLUE		IR			
	nW/cm <sup>2</sup> per LSB*	FULL SCALE (μW/cm <sup>2</sup> )	nW/cm <sup>2</sup> per LSB*	FULL SCALE (μW/cm <sup>2</sup> )		
00	4	65.536	2	32.768		
01	16	262.144	8	131.072		
10	64	1048.573	32	524.288		
11	1024	16777.2	512	8388.61		

In AMBTIM[2:0] = 100 mode (400ms integration time).

AMBPGA[1:0]	CLEAR		RED		GREEN	
	nW/cm <sup>2</sup> per LSB*	FULL SCALE (μW/cm <sup>2</sup> )	nW/cm <sup>2</sup> per LSB*	FULL SCALE (μW/cm <sup>2</sup> )	nW/cm <sup>2</sup> per LSB*	FULL SCALE (μW/cm <sup>2</sup> )
00	0.5	8.192	0.5	8.192	0.5	8.192
01	2	32.768	2	32.768	2	32.768
10	8	131.072	8	131.072	8	131.072
11	128	2097.153	128	2097.153	128	2097.153
AMBPGA[1:0]	BLUE		IR			
	nW/cm <sup>2</sup> per LSB*	FULL SCALE (μW/cm <sup>2</sup> )	nW/cm <sup>2</sup> per LSB*	FULL SCALE (μW/cm <sup>2</sup> )		
00	1	16.384	0.5	8.192		
01	4	65.536	2	32.768		
10	16	262.1433	8	131.072		
11	256	4194.3	128	2097.153		

\*At 14-bit resolution, 100ms ADC conversion time. Sensitivity is four times higher with 400ms integration time.

# MAX44005

## RGB Color, Temperature, and Infrared Proximity Sensor

### AMBTIM[2:0]

The three AMBTIM[2:0] bits set the integration time for the red/green/blue/IR/temp channel ADC conversion.

**Table 11. AMBTIM[2:0]**

AMBTIM[2:0]	INTEGRATION TIME (ms)	FULL-SCALE ADC (Counts)	BIT RESOLUTION	RELATIVE LSB SIZE FOR FIXED AMBPGA[1:0]
000	100	16,384	14	1x
001	25	4,096	12	4x
010	6.25	1,024	10	16x
011	1.5625	256	8	64x
100	400	16,384	14	1/4x
101	Reserved	Not applicable	Not applicable	Not applicable
110	Reserved	Not applicable	Not applicable	Not applicable
111	Reserved	Not applicable	Not applicable	Not applicable

### TEMPEN

**Table 12. TEMPEN**

BIT 6	OPERATION
0	Disables temperature sensor.
1	Enables temperature sensor.

The integration time of temperature sensor is controlled by the ambient mode settings. The temperature sensor is enabled only if the clear channel is on.

### COMPEN

**Table 13. COMPEN**

BIT 5	OPERATION
0	Disables IR compensation.
1	Enables IR compensation. Only for MODE[2:0] = 000 mode.

The integration time of compensation channel is controlled by the ambient mode settings. The compensation is enabled only when the clear channel is on. When COMPEN = 1, the CLEAR data is automatically compensated for stray IR leakage and temperature variations. When COMPEN = 0, the IR compensation is disabled, but the output of the IR compensation data exists.

**Table 14. Trim Adjust Enable (TRIM)**

BIT 7	OPERATION
0	Use factory-programmed gains for all the channels. Ignore any bytes written to the TRIM_GAIN_GREEN[6:0], TRIM_GAIN_RED[6:0], TRIM_GAIN_BLUE[6:0], TRIM_GAIN_CLEAR[6:0], and TRIM_GAIN_IR[6:0] registers.
1	Use bytes written to the TRIM_GAIN_GREEN[6:0], TRIM_GAIN_RED[6:0], TRIM_GAIN_BLUE[6:0], TRIM_GAIN_CLEAR[6:0], and TRIM_GAIN_IR[6:0] registers to set the gain for each channel.



# MAX44005

## RGB Color, Temperature, and Infrared Proximity Sensor

### Proximity Configuration Register (0x03)

REGISTER	BIT7	BIT6	BIT5	BIT4	BIT3	BIT2	BIT1	BIT0	REGISTER ADDRESS	POWER-ON RESET STATE	R/W
Proximity Configuration	DRV[3:0]						PRXTIM	PRXPGA	0x03	0x00	R/W

Writing to the Proximity Configuration register aborts any proximity data conversion (Registers 0x10 and 0x11) if already in progress, and applies the new settings immediately.

#### PRXPGA

The PRXPGA sets the gain of the IR channel in proximity mode measurement according to Table 15.

**Table 15. PRXPGA**

BIT0	$\mu\text{W}/\text{cm}^2$ per LSB*	FULL SCALE ( $\mu\text{W}/\text{cm}^2$ )
0	2	2095
1	16	16,777

\*At 14-bit resolution, 100ms ADC conversion time.

#### PRXTIM

The PRXTIM sets the integration time for IR channel ADC in proximity mode as shown in Table 16.

**Table 16. PRXTIM**

BIT1	ADC CONVERSION TIME (ms)	FULL-SCALE ADC (Counts)	BIT RESOLUTION
0	6.25	1024	10
1	1.5625	256	8

#### DRV[3:0]

The four bits of DRV set the LED drive current.

**Table 17. DRV[3:0]**

DRV[3:0]	LED CURRENT (mA)	DRV[3:0]	LED CURRENT (mA)
0000	LED driver disabled	0110	60
0001	10	0111	70
0010	20	1000	80
0011	30	1001	90
0100	40	1010	100
0101	50	1011-1111	110

# MAX44005

## RGB Color, Temperature, and Infrared Proximity Sensor

### AMBIENT Data Register (0x04–0x0F)

REGISTER	BIT7	BIT6	BIT5	BIT4	BIT3	BIT2	BIT1	BIT0	REGISTER ADDRESS	POWER-ON RESET STATE	R/W
<b>AMBIENT READING</b>											
Ambient CLEAR High Byte	—	—	AMB_CLEAR[13:8]						0x04	0x00	R
Ambient CLEAR Low Byte	AMB_CLEAR[7:0]						0x05	0x00	R		
Ambient RED High Byte	—	—	AMB_RED[13:8]						0x06	0x00	R
Ambient RED Low Byte	AMB_RED[7:0]						0x07	0x00	R		
Ambient GREEN High Byte	—	—	AMB_GREEN[13:8]						0x08	0x00	R
Ambient GREEN Low Byte	AMB_GREEN[7:0]						0x09	0x00	R		
Ambient BLUE High Byte	—	—	AMB_BLUE[13:8]						0x0A	0x00	R
Ambient BLUE Low Byte	AMB_BLUE[7:0]						0x0B	0x00	R		
Ambient INFRARED High Byte	—	—	AMB_IR[13:8]						0x0C	0x00	R
Ambient INFRARED Low Byte	AMB_IR[7:0]						0x0D	0x00	R		
Ambient IR COMP High Byte	—	—	AMB_IRCOMP[13:8]						0x0E	0x00	R
Ambient IR COMP Low Byte	AMB_IRCOMP[7:0]						0x0F	0x00	R		

The 12 registers here hold the results of ADC. AMB\_CLEAR[13:0], AMB\_RED[13:0], AMB\_GREEN[13:0], AMB\_BLUE[13:0], AMB\_IR[13:0], and AMB\_IRCOMP[13:0] hold the 14-bit ADC data of the clear/red/green/blue/IR/COMP channels. AMB\_IRCOMP[13:0] can be used to enhance overtemperature performance of the device. The resolution and bit length of the result is controlled by the value of AMBTIM[2:0] and AMBPGA[1:0] bits. The result is always right justified in registers, and the unused high bits are set to zero.

### Proximity Data Register (0x10, 0x11)

REGISTER	BIT7	BIT6	BIT5	BIT4	BIT3	BIT2	BIT1	BIT0	REGISTER ADDRESS	POWER-ON RESET STATE	R/W
PROXIMITY IR High Byte	—	—	—	—	—	—	PROX[9:8]		0x10	0x00	R
PROXIMITY IR Low Byte	PROX[7:0]						0x11	0x00	R		

The two bytes here (PROX[9:0]) hold the results of the proximity receive signal conversion. The resolution and bit length of the result is controlled by the value of the PRXTIM bits. The result is always right justified in the two registers, and the unused high bits are set to zero.

### Temperature Data Register (0x12–0x13)

REGISTER	BIT7	BIT6	BIT5	BIT4	BIT3	BIT2	BIT1	BIT0	REGISTER ADDRESS	POWER-ON RESET STATE	R/W
TEMP High Byte	—	—	TEMP[13:8]						0x12	0x00	R
TEMP Low Byte	TEMP[7:0]						0x13	0x00	R		

These two bytes hold the data of the temperature sensor.

# MAX44005

## RGB Color, Temperature, and Infrared Proximity Sensor

### Ambient Interrupt Threshold Registers (0x14–0x17)

REGISTER	BIT7	BIT6	BIT5	BIT4	BIT3	BIT2	BIT1	BIT0	REGISTER ADDRESS	POWER-ON RESET STATE	R/W
AMB Upper Threshold—High Byte	—	—	UPTHR[13:8]						0x14	0x00	R/W
AMB Upper Threshold—Low Byte	UPTHR[7:0]						0x15	0x00	R/W		
AMB Lower Threshold—High Byte	—	—	LOTHR[13:8]						0x16	0x00	R/W
AMB Lower Threshold—Low Byte	LOTHR[7:0]						0x17	0x00	R/W		

The Ambient Upper Threshold and Lower Threshold register bits (UPTHR[13:0] and LOTHR[13:0], respectively) set the window limits that are used to trigger an ambient interrupt, AMBINTS. It is important to set these values according to the selected bit resolution/integration time chosen for the ambient measurement based on the AMBTIM[2:0] and AMBPGA[1:0] settings. The upper two bits are always ignored. If the AMBINTEN bit is set, and the selected ambient channel data is outside the upper or lower thresholds for a period greater than that defined by the AMBPST persist time, the AMBINTS bit in the Status register are set and  $\overline{\text{INT}}$  pin is pulled low.

### AMB/PROX Threshold Persist Timer Register (0x18)

REGISTER	BIT7	BIT6	BIT5	BIT4	BIT3	BIT2	BIT1	BIT0	REGISTER ADDRESS	POWER-ON RESET STATE	R/W
Threshold Persist Timer	—	—	—	—	PRXPST[1:0]		AMPBST[1:0]		0x18	0x00	R/W

PRXPST[1:0] and AMPBST[1:0] set one of four persist values in Table 18 that control a time-delay before the interrupt logic reacts to a detected event. This feature is added to reduce false or nuisance interrupts.

**Table 18. PRXPST[1:0]/AMPBST[1:0]**

PRXPST[1:0] or AMPBST[1:0]	NO. OF CONSECUTIVE MEASUREMENTS REQUIRED TO TRIGGER AN INTERRUPT
00	1
01	4
10	8
11	16

When AMPBST[1:0] is set to 00 and the AMBINTEN bit is set to 1, the first time an AMB interrupt event is detected, the AMBINTS interrupt bit is set and the  $\overline{\text{INT}}$  pin goes low. If AMPBST[1:0] is set to 01, then four consecutive interrupt events must be detected on four consecutive measurement cycles. Similarly, if AMPBST[1:0] is set to 10 or 11, then 8 or 16 consecutive interrupt events must be detected. If there is an intervening measurement cycle where no interrupt event is detected, then the count is reset to zero. The proximity interrupt function is managed in the same way with PRXPST[1:0].

# MAX44005

## RGB Color, Temperature, and Infrared Proximity Sensor

### Proximity Threshold Registers (0x19–0x1C)

REGISTER	BIT7	BIT6	BIT5	BIT4	BIT3	BIT2	BIT1	BIT0	REGISTER ADDRESS	POWER-ON RESET STATE	R/W
PROX Upper Threshold—High Byte	—	—	—	—	—	—	PRXUPTH[9:8]		0x19	0xFF	R/W
PROX Upper Threshold—Low Byte	PRXUPTH[7:0]								0x1A	0xFF	R/W
PROX Lower Threshold—High Byte	—	—	—	—	—	—	PRXLOTHR[9:8]		0x1B	0x00	R/W
PROX Lower Threshold—Low Byte	PRXLOTHR[7:0]								0x1C	0x00	R/W

The proximity upper and lower thresholds (PRXUPTH[9:0] and PRXLOTHR[9:0], respectively) set the window limits that are used to trigger a proximity interrupt, and PRXINTS is set. It is important to set these values according to the selected bit resolution/integration time chose for the PRXTIM measurement based on the PRXTIM and PRXPGA settings. If the PRXINTE bit is set, and the proximity channel data is outside the upper or lower thresholds for a period greater than that defined by the PRXPST persist time, the PRXINTS bit in the Status register is set and the  $\overline{INT}$  pin is pulled low.

### Gain Trim Registers (0x1D–0x21)

TRIM\_GAIN\_CLEAR is used to trim the gain of the clear channel.

REGISTER	BIT7	BIT6	BIT5	BIT4	BIT3	BIT2	BIT1	BIT0	REGISTER ADDRESS	POWER-ON RESET STATE	R/W
Digital Gain Trim of CLEAR Channel		TRIM_GAIN_CLEAR[6:0]							0x1D	0xFF	R/W
Digital Gain Trim of RED Channel		TRIM_GAIN_RED[6:0]							0x1E	0xFF	R/W
Digital Gain Trim of GREEN Channel		TRIM_GAIN_GREEN[6:0]							0x1F	0xFF	R/W
Digital Gain Trim of BLUE Channel		TRIM_GAIN_BLUE[6:0]							0x20	0xFF	R/W
Digital Gain Trim of INFRARED Channel		TRIM_GAIN_IR[6:0]							0x21	0xFF	R/W

TRIM\_GAIN\_RED is used to trim the gain of the red channel. TRIM\_GAIN\_GREEN is used to trim the gain of the green channel. TRIM\_GAIN\_BLUE is used to trim the gain of the blue channel. TRIM\_GAIN\_IR is used to trim the gain of the IR channel. These registers are loaded with the factory trimmed gains on power-up. When the TRIM bit in Register 0x02 is set to 1, these registers can be overwritten with user-chosen gains. When the TRIM bit is set back to 0, these registers are automatically reloaded with factory-trimmed values.

# MAX44005

## RGB Color, Temperature, and Infrared Proximity Sensor

### Applications Information

#### Ambient Sensing Applications

Typical applications involve placing the IC behind glass with a small semi-transparent window placed above it. Use the photodiode sensitive area as shown in Figure 2 to properly position the window above the part.

The part comes equipped with Internal Gain Trim registers for the CLEAR, RGB, and IR AMB photodiodes. By suitably choosing the gains for these channels, one can generate accurate ambient light readings in all lighting conditions irrespective of type of glass the part is used under. This is especially useful for color-glass applications where for cosmetic reasons the part is placed behind a color film to hide its presence and to blend with the product cosmetic look. This film has the peculiar

property of attenuating most ambient light, but passing through infrared radiation.

It is possible to map the RGB color values to an XY coordinate system for ambient color temperature and color gamut display.

#### Proximity Sensing Applications

The IC integrates a novel proximity sensor interface circuit with a robust built-in ambient IR cancellation scheme. The internal DC IR rejection circuit eliminates problems of ADC saturation in the presence of strong ambient infrared radiation, such as bright sunlight. Further, the proximity sensor uses a single-pulse scheme for the IR transmitter that eliminates red-glow problems seen in competing solutions to drive 850nm IR LEDs, while also reducing average IR LED power consumption to less than 0.01% of the IR LED peak current.

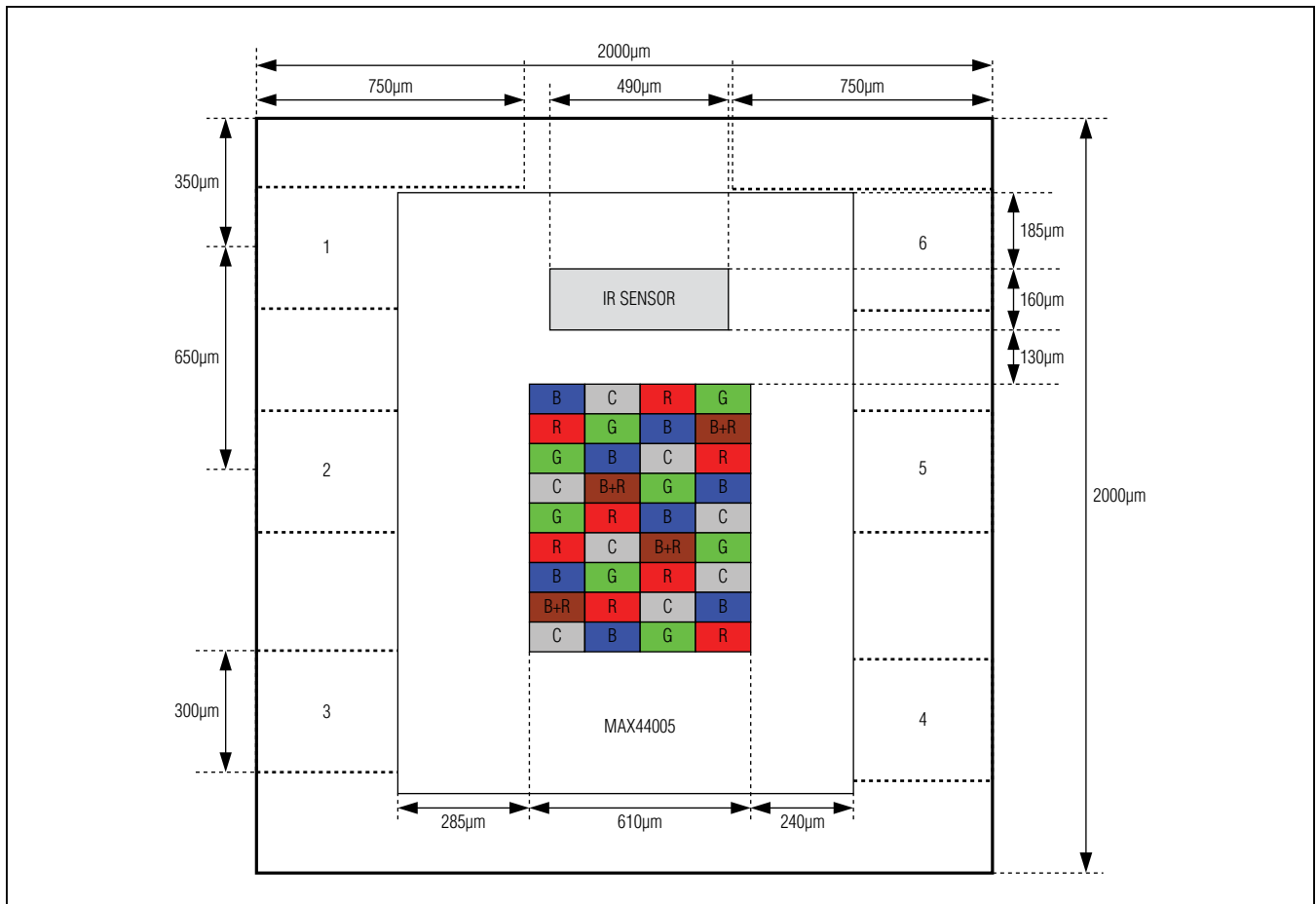

Figure 2. Photodiode Location

# MAX44005

## RGB Color, Temperature, and Infrared Proximity Sensor

### Interrupt Operation

Ambient interrupt is enabled by setting bit 0 of Register 0x01 to 1 and proximity interrupt is enabled by setting bit 1 of Register 0x01 to 1 (see Tables 6 and 7). The interrupt pin,  $\overline{INT}$ , is an open-drain output and pulls low when an interrupt condition occurs (e.g., when ambient lux readings exceed threshold limits for a period greater than that set by the persist timer register). The interrupt status bit is cleared automatically if Register 0x00 is read or if the interrupts are disabled.

A PWRON interrupt bit is set to alert the master of a chip reset operation in case of a power-supply glitch, which can happen on smartphones that place the light sensor on a flex with a small connector.

It is recommended to utilize the interrupt pin on the IC to alert the master to come and read measurements from the IC. This eliminates the need for the microcontroller (I<sup>2</sup>C master) to continually poll the device for information. Due to the use of pullup resistors on the I<sup>2</sup>C bus, minimizing I<sup>2</sup>C bus activity can reduce power consumption substantially. In addition, this frees up the microcontroller resources to service other background processes to improve device performance. The wide variety of smarts available on the chip, such as ability to set the threshold levels and to count persist timer limits, allow the part to operate in an autonomous mode most of the time.

### Typical Operating Sequence

Here is the typical operating sequence for the master to communicate to the IC:

A. Setup:

- 1) Read the Interrupt Status register (0x00) to confirm only the PWRON bit is set (usually at power-up only). This also clears a hardware interrupt.
- 2) Set the Threshold and Persist Timer registers for ambient and proximity sensor measurements.
- 3) Write 0x01 to Proximity Configuration register (Register 0x03) to set the proximity sensor in the lowest gain setting, AMB sensor in the highest gain

setting, and the PROX and AMB ADCs are in 10-bit and 14-bit modes separately.

- 4) Set IR LED current to suitable level by writing to the Transmit Configuration register (0x03).
- 5) Write 0x43 to Main Configuration register (Register 0x01) to set the part in RGBC + IR + PROX mode, and to enable AMB and proximity interrupts. Ensure RGBC + IR + PROX mode is enabled.
- 6) Set new CLEAR, RGB, and infrared channel gains if necessary to customize AMB operation for application conditions. Ensure TRIM bit is set to 1 when not using default factory-trim settings. Otherwise, keep this bit set to 0 (power-on default state).

B. Wait for interrupt.

C. On interrupt:

- 1) Read the Interrupt Status register (0x00) to confirm the IC to be source of interrupt and to check for type of interrupt. This should clear the hardware interrupt on the part, if set.
- 2) If an AMB interrupt has occurred, read AMB registers (Register 0x04-0x0D) to confirm if data is valid, and take appropriate action (e.g., sets new backlight strength). Set new AMB thresholds if necessary.
- 3) If a PROX interrupt has occurred, read the PROX IR registers (Registers 0x10-0x11) and take appropriate action (typically turn off or turn on touch screen and backlight). Set new proximity thresholds if necessary.
- 4) Return to step B.

### I<sup>2</sup>C Serial Interface

The IC features an I<sup>2</sup>C/SMBus-compatible, 2-wire serial interface consisting of a serial-data line (SDA) and a serial-clock line (SCL). SDA and SCL facilitate communication between the IC and the master at clock rates up to 400kHz. Figure 3 shows the 2-wire interface timing diagram. The master generates SCL and initiates data

Table 19. Slave Address

SLAVE ADDRESS FOR WRITING	SLAVE ADDRESS FOR READING
1000 1000	1000 1001

# MAX44005

## RGB Color, Temperature, and Infrared Proximity Sensor

transfer on the bus. A master device writes data to the IC by transmitting the proper slave address followed by the register address and then the data word. Each transmit sequence is framed by a START (S) or REPEATED START (Sr) condition and a STOP (P) condition. Each word transmitted to the IC is 8 bits long and is followed by an acknowledge clock pulse. A master reading data from the IC transmits the proper slave address followed by a series of nine SCL pulses. The IC transmits data on SDA in sync with the master-generated SCL pulses. The master acknowledges receipt of each byte of data. Each read sequence is framed by a START or REPEATED START condition, a not acknowledge, and a STOP condition. SDA operates as both an input and an open-drain output. A pullup resistor, typically greater than  $500\Omega$ , is required on the SDA bus. SCL operates as only an input. A pullup resistor, typically greater than  $500\Omega$ , is required on SCL if there are multiple masters on the bus, or if the master in a single-master system has an open-drain SCL output. Series resistors in line with SDA and SCL are optional. Series resistors protect the digital inputs of the

IC from high-voltage spikes on the bus lines, and minimize crosstalk and undershoot of the bus signal.

### Bit Transfer

One data bit is transferred during each SCL cycle. The data on SDA must remain stable during the high period of the SCL pulse. Changes in SDA while SCL is high are control signals. See the *START and STOP Conditions* section. SDA and SCL idle high when the I<sup>2</sup>C bus is not busy.

### START and STOP Conditions

SDA and SCL idle high when the bus is not in use. A master initiates communication by issuing a START condition. A START condition is a high-to-low transition on SDA with SCL high. A STOP condition is a low-to-high transition on SDA while SCL is high (Figure 4). A START condition from the master signals the beginning of a transmission to the IC. The master terminates transmission and frees the bus by issuing a STOP condition. The bus remains active if a REPEATED START condition is generated instead of a STOP condition.

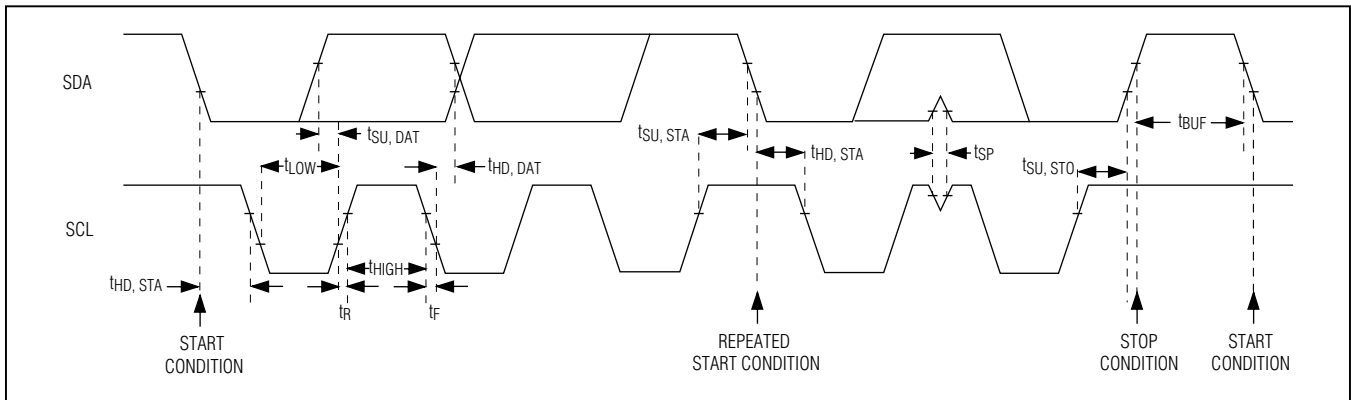

Figure 3. 2-Wire Interface Timing Diagram

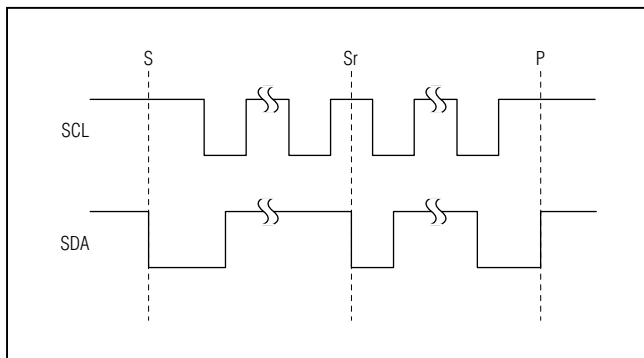

Figure 4. START, STOP, and REPEATED START Conditions

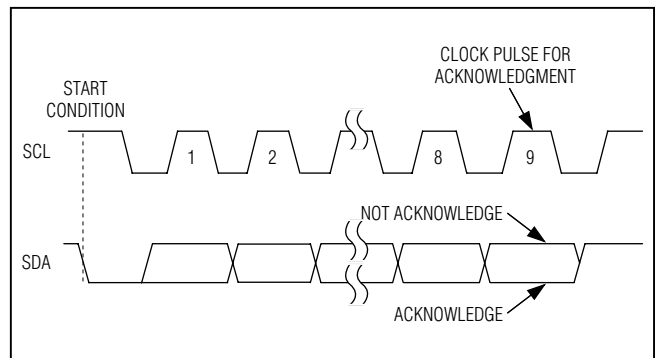

Figure 5. Acknowledge

# MAX44005

## RGB Color, Temperature, and Infrared Proximity Sensor

### Early STOP Conditions

The IC recognizes a STOP condition at any point during data transmission except if the STOP condition occurs in the same high pulse as a START condition. For proper operation, do not send a STOP condition during the same SCL high pulse as the START condition.

### Acknowledge

The acknowledge bit (ACK) is a clocked ninth bit that the IC uses to handshake receipt each byte of data when in write mode (Figure 5). The IC pulls down SDA during the entire master-generated ninth clock pulse if the previous byte is successfully received. Monitoring ACK allows for detection of unsuccessful data transfers. An unsuccessful data transfer occurs if a receiving device is busy or if a system fault has occurred. In the event of an unsuccessful data transfer, the bus master may retry communication. The master pulls down SDA during the ninth clock

cycle to acknowledge receipt of data when the IC is in read mode. An acknowledge is sent by the master after each read byte to allow data transfer to continue. A not acknowledge is sent when the master reads the final byte of data from the IC, followed by a STOP condition.

### Write Data Format

A write to the IC includes transmission of a START condition, the slave address with the R/W bit set to 0, one byte of data to configure the internal register address pointer, one or more bytes of data, and a STOP condition. Figure 6 illustrates the proper frame format for writing one byte of data to the IC. Figure 7 illustrates the frame format for writing n-bytes of data to the IC.

The slave address with the R/W bit set to 0 indicates that the master intends to write data to the IC. The IC acknowledge receipt of the address byte during the master-generated ninth SCL pulse.

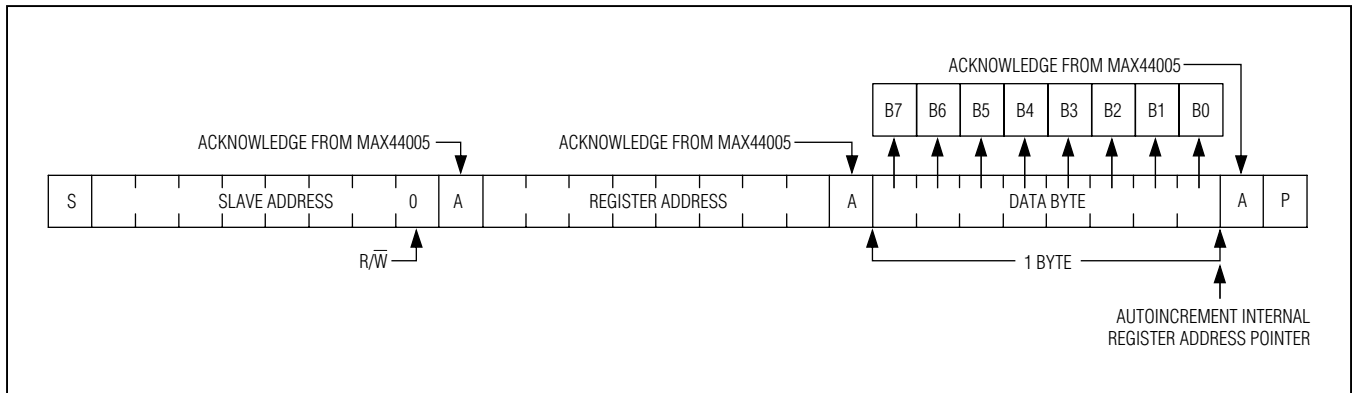

Figure 6. Writing 1 Byte of Data to the IC

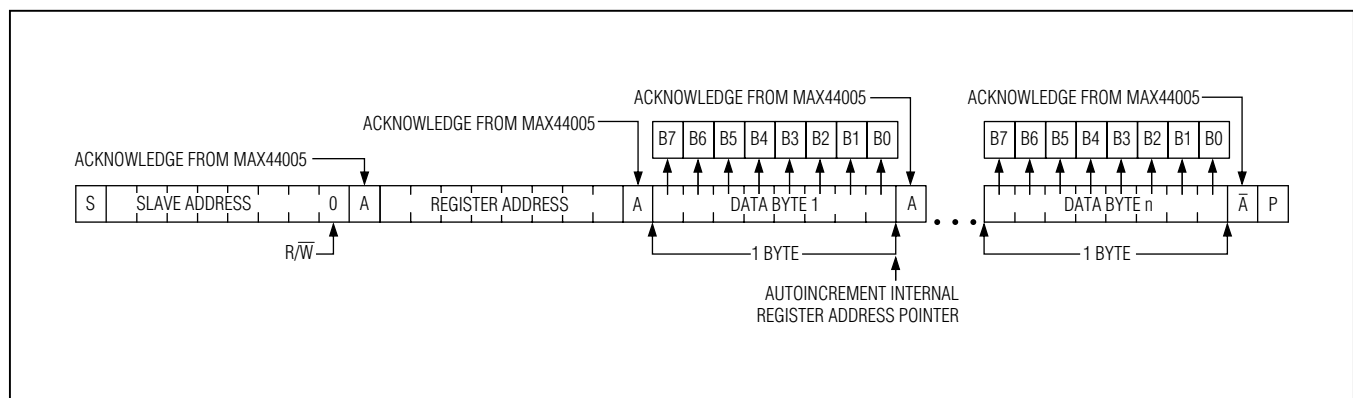

Figure 7. Writing n-Bytes of Data to the IC



# MAX44005

## RGB Color, Temperature, and Infrared Proximity Sensor

The second byte transmitted from the master configures the IC's internal register address pointer. The pointer tells the IC where to write the next byte of data. An acknowledge pulse is sent by the IC upon receipt of the address pointer data.

The third byte sent to the IC contains the data that is written to the chosen register. An acknowledge pulse from the IC signals receipt of the data byte. The address pointer autoincrements to the next register address after each received data byte. This autoincrement feature allows a master to write to sequential registers within one continuous frame. Figure 8 illustrates how to write to multiple registers with one frame. The master signals the end of transmission by issuing a STOP condition.

### Read Data Format

Send the slave address with the  $R/\bar{W}$  bit set to 1 to initiate a read operation. The IC acknowledges receipt of its slave address by pulling SDA low during the ninth SCL clock pulse. A START command followed by a read command resets the address pointer to Register 0x00. The first byte transmitted from the IC is the content of Register 0x00. Transmitted data is valid on the rising edge of the master-generated serial clock (SCL). The address pointer autoincrements after each read data byte. This autoincrement feature allows all registers to be read sequentially

within one continuous frame. A STOP condition can be issued after any number of read data bytes. If a STOP condition is issued followed by another read operation, the first data byte to be read is from Register 0x00 and subsequent reads autoincrement the address pointer until the next STOP condition. The address pointer can be preset to a specific register before a read command is issued. The master presets the address pointer by first sending the IC's slave address with the  $R/\bar{W}$  bit set to 0 followed by the register address. A REPEATED START condition is then sent followed by the slave address with the  $R/\bar{W}$  bit set to 1. The IC transmits the contents of the specified register. The address pointer autoincrements after transmitting the first byte. Attempting to read from register addresses higher than 0xFF results in repeated reads of 0xFF. Note that 0xF6 to 0xFF are reserved registers. The master acknowledges receipt of each read byte during the acknowledge clock pulse. The master must acknowledge all correctly received bytes except the last byte. The final byte must be followed by a not acknowledge from the master and then a STOP condition. Figure 8 illustrates the frame format for reading one byte from the IC. Figure 9 illustrates the frame format for reading multiple bytes from the IC.

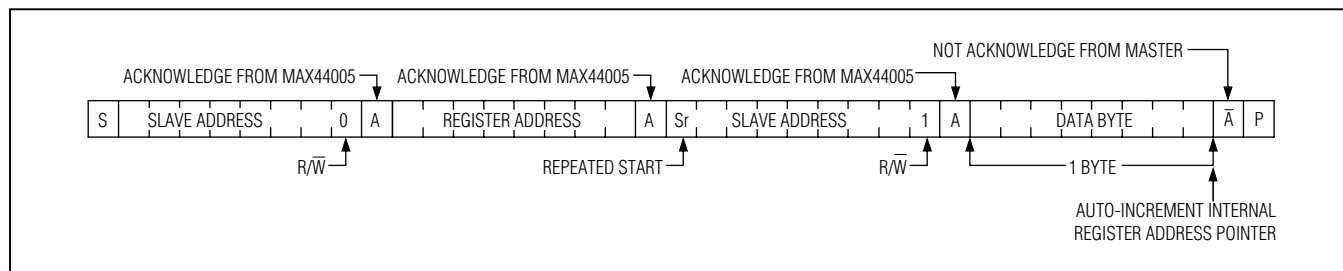

Figure 8. Reading One Indexed Byte of Data from the IC

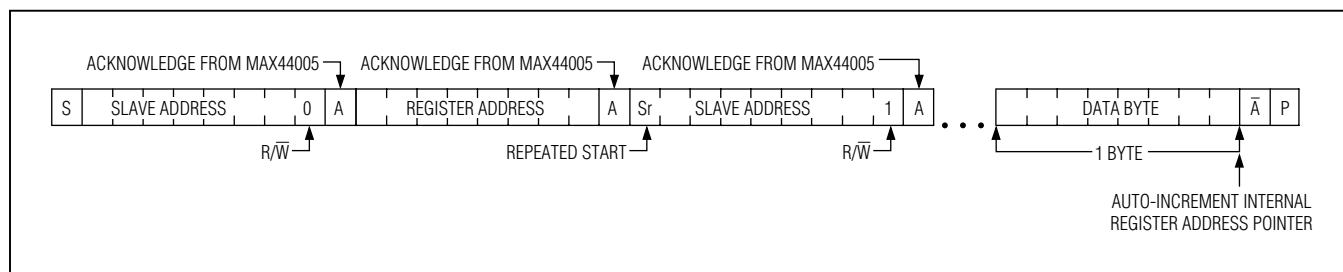
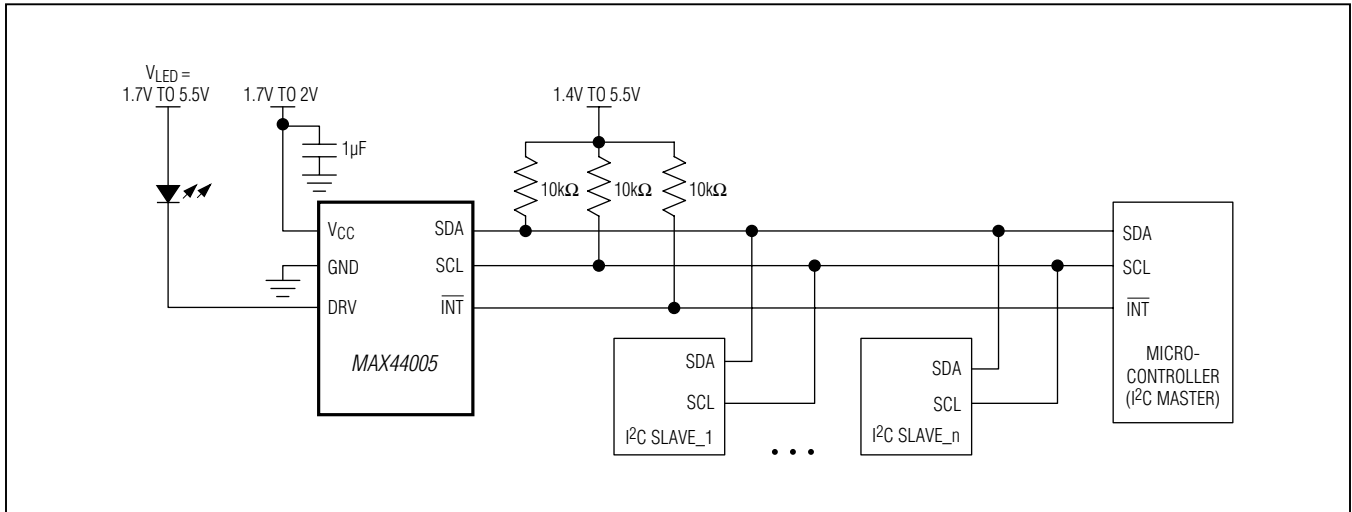

Figure 9. Reading n-Bytes of Indexed Data from the IC

# MAX44005

## RGB Color, Temperature, and Infrared Proximity Sensor

### Typical Application Circuit



### Ordering Information

PART	PIN-PACKAGE	TEMP RANGE
MAX44005EDT+	6 OTDFN	-40°C to +85°C

+Denotes a lead(Pb)-free/RoHS-compliant package.