



Chipsmall Limited consists of a professional team with an average of over 10 year of expertise in the distribution of electronic components. Based in Hongkong, we have already established firm and mutual-benefit business relationships with customers from,Europe,America and south Asia,supplying obsolete and hard-to-find components to meet their specific needs.

With the principle of “Quality Parts,Customers Priority,Honest Operation,and Considerate Service”,our business mainly focus on the distribution of electronic components. Line cards we deal with include Microchip,ALPS,ROHM,Xilinx,Pulse,ON,Everlight and Freescale. Main products comprise IC,Modules,Potentiometer,IC Socket,Relay,Connector.Our parts cover such applications as commercial,industrial, and automotives areas.

We are looking forward to setting up business relationship with you and hope to provide you with the best service and solution. Let us make a better world for our industry!



Contact us

Tel: +86-755-8981 8866 Fax: +86-755-8427 6832

Email & Skype: info@chipsmall.com Web: www.chipsmall.com

Address: A1208, Overseas Decoration Building, #122 Zhenhua RD., Futian, Shenzhen, China



MAX44286

Low-Power, Precision, 4-Bump WLP, Current-Sense Amplifier

General Description

The MAX44286 is a zero-drift, high-side current-sense amplifier family that offers precision, low supply current and is available in a tiny 4-bump ultra-thin WLP of 0.78mm x 0.78mm x 0.35mm footprint. This miniature size is of paramount for today's applications in smartphones, mobile accessories, notebooks, portable medical, and all battery-operated portable devices where current monitoring with precision and space are critical.

The MAX44286 has voltage output offered in four gain versions of 25V/V, 50V/V, 100V/V, and 200V/V. These four gain versions offer flexibility in the choice of the sense resistor and the very low input offset voltage helps in detecting small currents on the orders of low microamps. Low power capability also offers the possibility of minimizing power dissipation.

The MAX44286 operates with a supply voltage range of 1.6V to 5.5V over the -40°C to $+85^{\circ}\text{C}$ temperature range and from 1.8V to 5.5V over the -40°C to $+125^{\circ}\text{C}$ automotive temperature range. Supply voltage for the device is shared with the RS+ pin to fit the MAX44286 in a 4-bump, ultra-thin WLP package.

Applications

- Power Management Systems
- Portable/Battery-Powered Systems
- Smartphones
- Mobile Accessories
- Portable Medical
- Notebook Computers and Tablets

Ordering Information appears at end of data sheet.

For related parts and recommended products to use with this part, refer to www.maximintegrated.com/MAX44286.related.

Features and Benefits

- Ultra-Low Input Offset Voltage and Tiny Gain Error Allow Sense Resistor to Detect Tiny Currents (nA)
 - 30 μV (max) Offset Voltage
 - 0.23% (max) Gain Accuracy
- Low Current Consumption Saves Power
 - 12.5 μA I_{CC} for 200kHz Gain Bandwidth
- Space-Saving 4-Bump WLP Package
 - 0.78mm x 0.78mm x 0.35mm
- Industry-Leading Low-Power Supply Range
 - 1.6V to 5.5V Input Common Mode
- Four Gain Options Offer Flexibility in Sense Resistor Selection
 - G = 25V/V (MAX44286T)
 - G = 50V/V (MAX44286F)
 - G = 100V/V (MAX44286H)
 - G = 200V/V (MAX44286W)

Typical Application Circuit

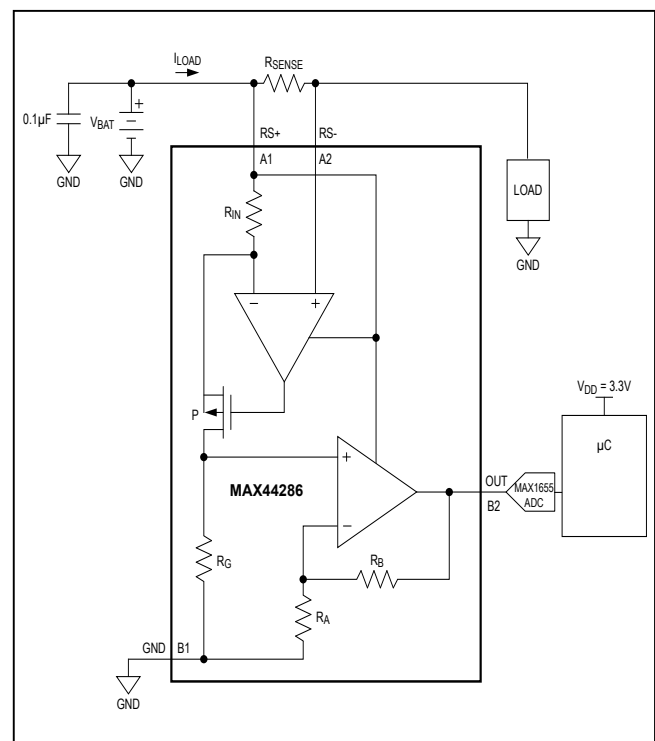

Absolute Maximum Ratings

RS+, RS- to GND	-0.3V to +6V	Operating Temperature Range	-40°C to +125°C
OUT to GND	-0.3V to (V _{RS+} + 0.3)V	Junction Temperature	+150°C
RS+ to RS-	-0.3V to +6V	Storage Temperature Range	-65°C to +150°C
Short-Circuit Duration (OUT to Any Other Pins)	Continuous	Soldering Temperature (reflow)	+260°C
Continuous Input Current (Any Pin)	±20mA		
Continuous Power Dissipation (T _A = +70°C)			
WLP (derate 9.7mW/°C above +70°C)	776mW		

Stresses beyond those listed under "Absolute Maximum Ratings" may cause permanent damage to the device. These are stress ratings only, and functional operation of the device at these or any other conditions beyond those indicated in the operational sections of the specifications is not implied. Exposure to absolute maximum rating conditions for extended periods may affect device reliability.

Package Thermal Characteristics (Note 1)

WLP
Junction-to-Ambient Thermal Resistance (θ_{JA}) 103°C/W

Note 1: Package thermal resistances were obtained using the method described in JEDEC specification JESD51-7, using a four-layer board. For detailed information on package thermal considerations, refer to www.maximintegrated.com/thermal-tutorial.

Electrical Characteristics

(V_{RS+} = V_{RS-} = 3.6V, V_{SENSE} = 0V, T_A = -40°C to +125°C, unless otherwise noted. Typical values are at T_A = +25°C.) (Note 2)

PARAMETER	SYMBOL	CONDITIONS	MIN	TYP	MAX	UNITS
Supply Current	I _S	T _A = +25°C		12.5	17	µA
		-40°C < T _A < +125°C			20	
Common-Mode Input Range	V _{CM}	Guaranteed by CMRR, -40°C < T _A < +125°C	1.8		5.5	V
		Guaranteed by CMRR, -40°C < T _A < +85°C	1.6		5.5	
Common-Mode Rejection Ratio/ Power-Supply Rejection Ratio	CMRR, PSRR	1.8V < V _{RS+} < 5.5V, V _{SENSE} = 10mV		120	100	dB
		1.6V < V _{RS+} < 5.5V, -40°C < T _A < +85°C, V _{SENSE} = 10mV		120	100	
Input Offset Voltage (Note 3)	V _{OS}	T _A = +25°C		7	30	µV
		-40°C < T _A < +125°C			50	
Input Offset Voltage Drift (Note 3)	TCV _{OS}			40	300	nV/°C
Gain	G	MAX44286T		25		V/V
		MAX44286F		50		
		MAX44286H		100		
		MAX44286W		200		
Gain Error (Note 4)	GE	T _A = +25°C		0.1	0.23	%
		-40°C < T _A < +125°C			0.25	
Input Bias Current RS-	I _{RS-}			0.02	1	nA
Capacitive Loading	C _L	No sustained oscillations		400		pF
OUT Low Voltage	V _{OL}	Sink current = 300µA		30	65	mV
		Sink current = 0µA		3	15	

Electrical Characteristics (continued)

($V_{RS+} = V_{RS-} = 3.6V$, $V_{SENSE} = 0V$, $T_A = -40^{\circ}C$ to $+125^{\circ}C$, unless otherwise noted. Typical values are at $T_A = +25^{\circ}C$.) (Note 2)

PARAMETER	SYMBOL	CONDITIONS	MIN	TYP	MAX	UNITS
OUT High Voltage	$V_{RS+} - V_{OH}$	Source current = $300\mu A$		28	50	mV
		Source current = $0\mu A$		1	2	
Gain-Bandwidth Product	GBW	$V_{SENSE} = 20mV$		200		kHz
Slew Rate	SR	$\Delta V_{OUT} = 2V_{P-P}$, $C_L = 100pF$		0.08		V/ μs
Voltage Noise Density	V_n	$f = 1kHz$		66		nV/ \sqrt{Hz}
Output Settling Time	t_S	0.1% final value, $\Delta V_{OUT} = 2V_{P-P}$		75		μs
Power-Up Time	t_{ON}			350		μs

Note 2: All devices are 100% production tested at $T_A = +25^{\circ}C$. All temperature limits are guaranteed by design.

Note 3: Guaranteed by design.

Note 4: Gain Error is calculated by applying two values of V_{SENSE} for each gain:

- G = 25: $V_{SENSE} = 4mV$ and $120mV$
- G = 50: $V_{SENSE} = 2mV$ and $60mV$
- G = 100: $V_{SENSE} = 1mV$ and $30mV$
- G = 200: $V_{SENSE} = 0.5mV$ and $15mV$

Typical Operating Characteristics

($V_{RS+} = V_{RS-} = 3.6V$, $V_{SENSE} = 0V$, $T_A = +25^{\circ}C$, unless otherwise noted.)

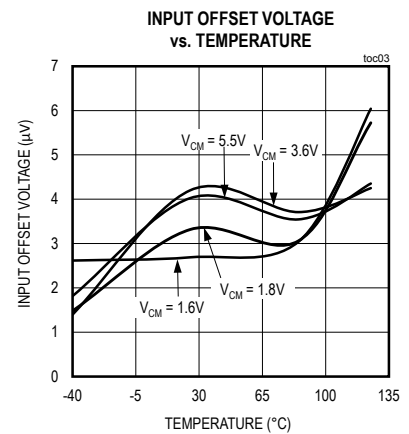
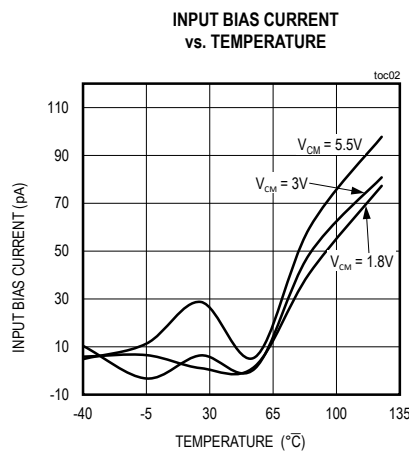
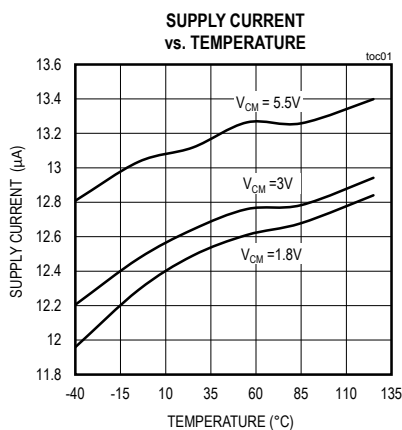

Typical Operating Characteristics (continued)

($V_{RS+} = V_{RS-} = 3.6V$, $V_{SENSE} = 0V$, $T_A = +25^{\circ}C$, unless otherwise noted.)

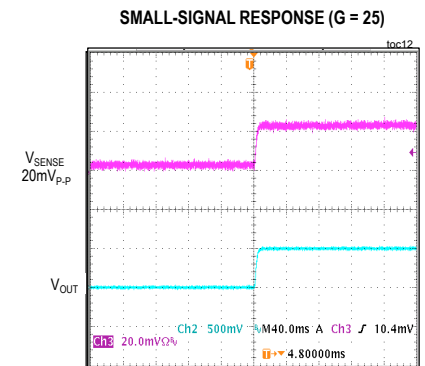
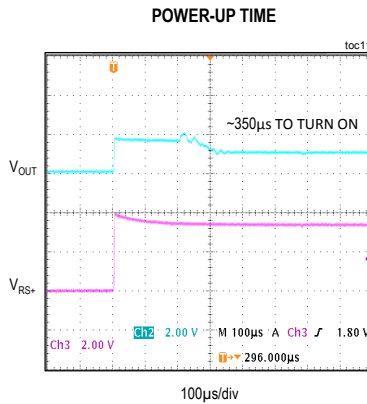
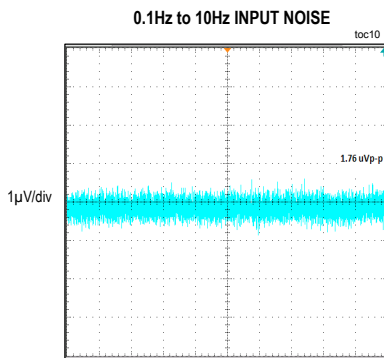
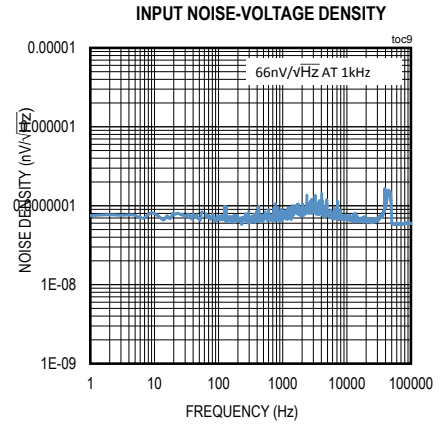
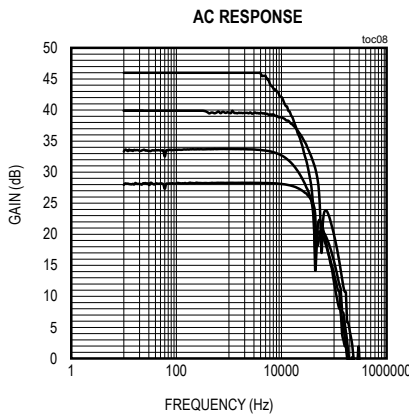
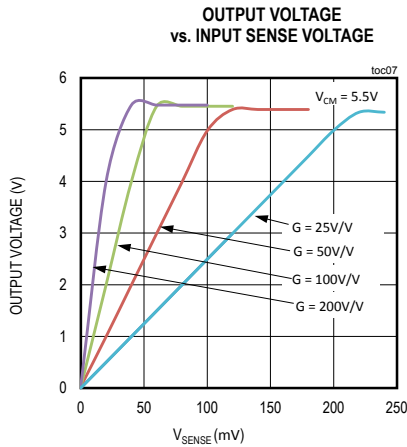
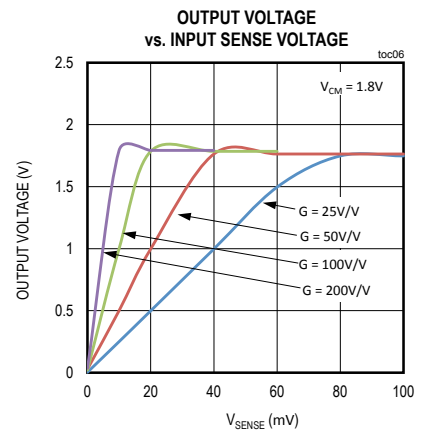
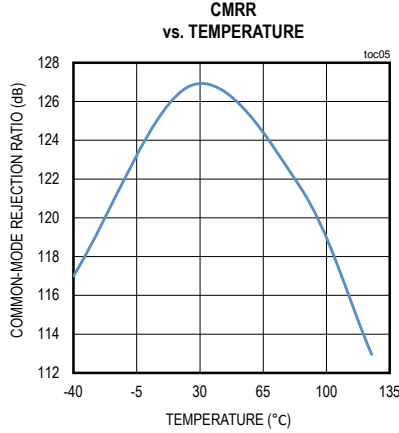
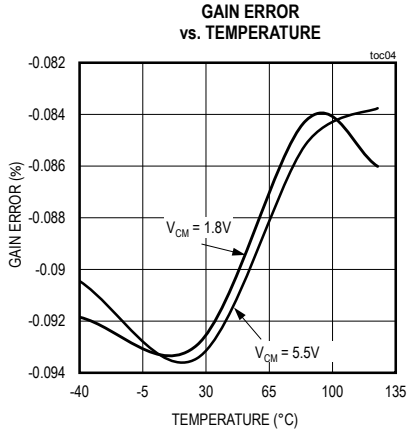

Typical Operating Characteristics (continued)

($V_{RS+} = V_{RS-} = 3.6V$, $V_{SENSE} = 0V$, $T_A = +25^{\circ}C$, unless otherwise noted.)

LARGE-SIGNAL RESPONSE (G = 25)

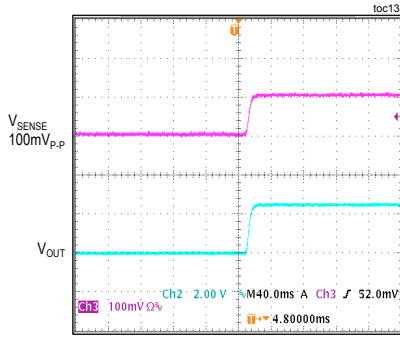

SMALL-SIGNAL RESPONSE (G = 50)

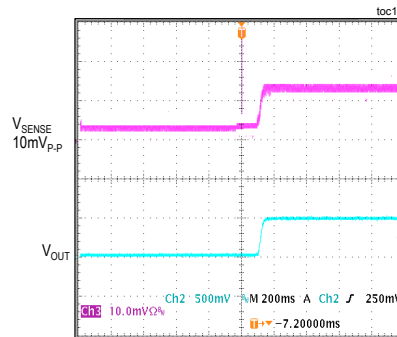

LARGE-SIGNAL RESPONSE (G = 50)

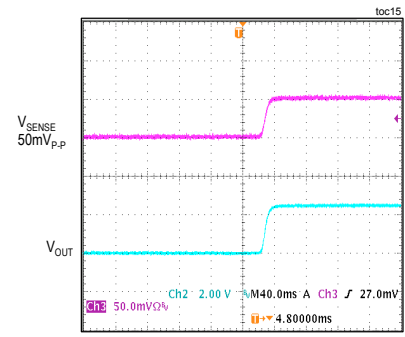

SMALL-SIGNAL RESPONSE (G = 100)

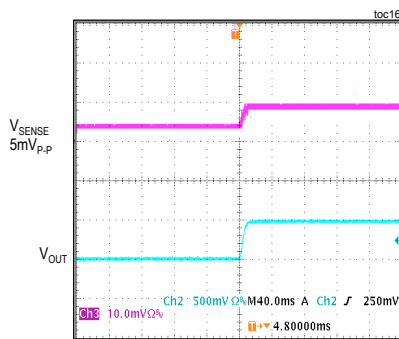

LARGE-SIGNAL RESPONSE (G = 100)

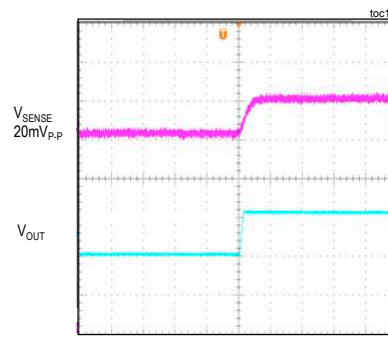

SMALL-SIGNAL RESPONSE (G = 200)

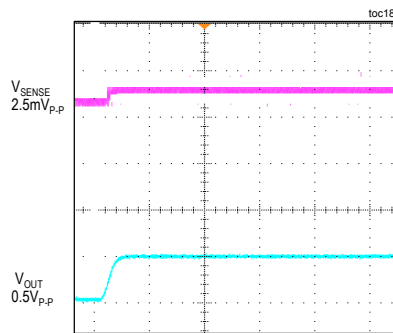

LARGE-SIGNAL RESPONSE (G = 200)

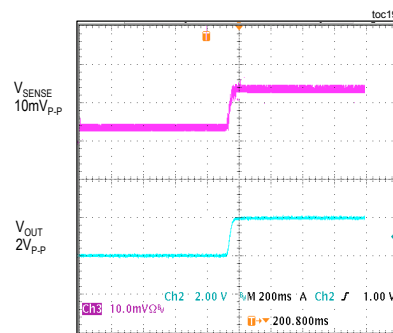

Pin Configuration

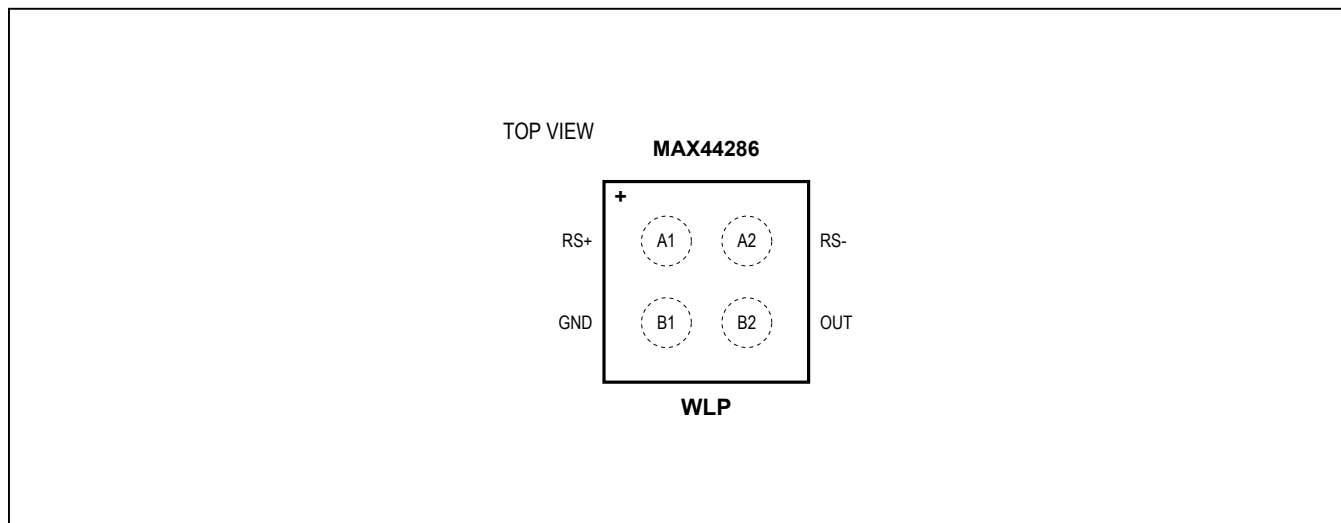

Pin Description

BUMP	NAME	FUNCTION
A1	RS+	Power-Side Connection to External Sense Resistor
A2	RS-	Load-Side Connection to External Sense Resistor
B1	GND	Ground
B2	OUT	Output

Functional Diagram

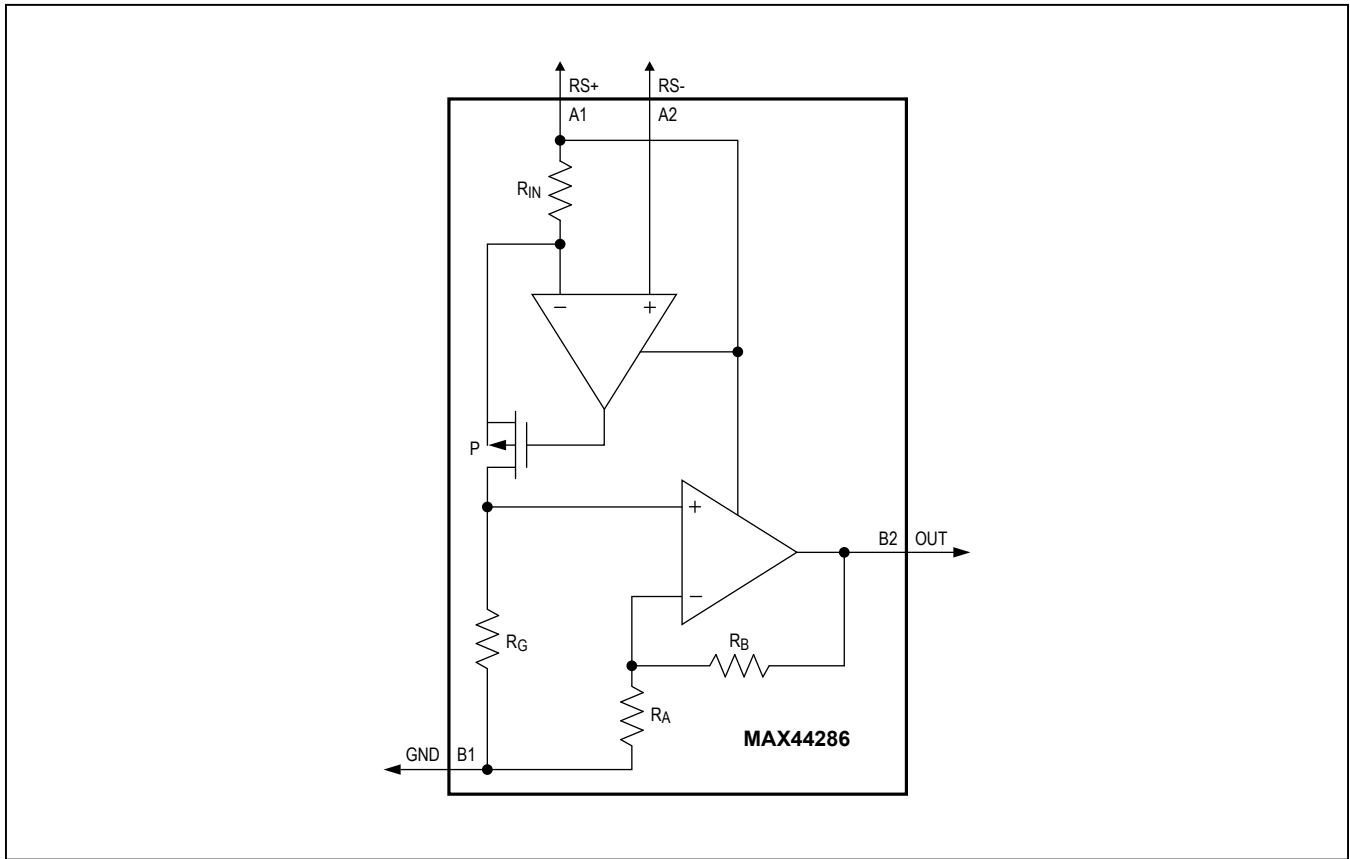

Table 1. Internal Gain-Setting Resistors (Typical Values)

PART	GAIN(V/V)	R _{IN} (kΩ)	R _G (kΩ)	R _A (kΩ)	R _B (kΩ)
MAX44286T	25	10	50	100	400
MAX44286F	50	10	50	50	450
MAX44286H	100	10	50	25	475
MAX44286W	200	10	50	12.5	487.5

Detailed Description

The MAX44286 unidirectional high-side, current-sense amplifier family implements a unique autozeroing technique to minimize the input offset voltage with close to zero offset drift over time and temperature. This technique achieves 7 μ V (max) input offset voltage.

The MAX44286 operates with the same supply and input common-mode voltage range from 1.6V to 5.5V without a need for an extra supply voltage terminal. This feature allows direct current monitoring of a battery voltage as low as +1.6V, and the part consumes only 12 μ A (typ) through the RS+ input when there is no differential input voltage applied.

The MAX44286 has an internal architecture that forces current through internal gain resistor R_{IN} depending on the magnitude of sense voltage drop across sense resistor. Due to the effect of negative feedback, the voltage drop across R_{IN} is the same as the voltage drop across the sense resistor R_{SENSE}. The current through R_{IN} is the same as the current through R_G. The voltage across R_G is then amplified through the gain-setting resistor R_A and feedback resistor R_B. The output voltage can be calculated based on the following equation:

$$V_{OUT} = V_{SENSE} \times \left(\frac{R_G}{R_{IN}} \right) \times \left(1 + \frac{R_B}{R_A} \right)$$

Applications Information

Power Supply, Bypassing, and Layout

Good layout technique optimizes performance by decreasing the amount of stray capacitance at the high-side, current-sense-amplifier, common-mode inputs and output. Capacitive decoupling across the battery voltage to GND of 0.1 μ F is recommended as shown in the [Typical Application Circuit](#). Since the MAX44286 features ultra-low input offset voltage, board leakage, and thermocouple effects can easily introduce errors in the input offset voltage readings when used with high-impedance signal sources. For noisy digital environments, the use of a multilayer PCB with separate ground and power-supply planes is recommended. Keep digital signals far away from the sensitive analog common mode inputs.

Choosing the Sense Resistor

Choose R_{SENSE} based on the following criteria:

Voltage Loss

A high R_{SENSE} value causes the power-source voltage to drop due to IR loss. For minimal voltage loss, use the lowest R_{SENSE} value.

OUT Swing vs. V_{RS+} and V_{SENSE}

The MAX44286 is unique because the supply voltage is the input common-mode voltage (the average voltage at RS+ and RS-). There is no separate V_{CC} supply voltage input. Therefore, the OUT voltage swing is limited by the minimum voltage at RS+.

$$V_{OUT(MAX)} = V_{RS+(MIN)} - V_{SENSE(FS)} - V_{OH}$$

and:

$$R_{SENSE} = V_{OUT(MAX)} / (\text{Gain} \times I_{LOAD(MAX)})$$

Accuracy

In the linear region ($V_{OUT} < V_{OUT(MAX)}$), there are two components to accuracy: input offset voltage (V_{OS}) and gain error (GE). For the MAX44286, V_{OS} = 7 μ V (max) and gain error is 0.15% (max). To calculate the total error, use the linear equation:

$$V_{OUT} = (\text{Gain} \pm \text{GE}) \times V_{SENSE} \pm (\text{gain} \times V_{OS})$$

A high R_{SENSE} value allows lower currents to be measured more accurately because offsets are less significant when the sense voltage is larger. For extremely low input offset voltage and gain error that this part offers, this output voltage error is insignificant.

Full-Scale Sense Voltage Range V_{SENSE(FS)}

The gain error of the MAX44286 is production tested and guaranteed with V_{DD} = 3.6V over a V_{SENSE} range as shown in Note 4 of the [Electrical Characteristics](#) table. It is important to note that a higher V_{SENSE} range can be obtained if a higher V_{DD} supply is available.

The following equation applies:

$$V_{SENSE(FS)} = (V_{DD} - 0.6) / \text{Gain}$$

For example, using the MAX44286F (for which G=50) at a V_{DD} = 5.5V:

$$V_{SENSE(FS)} = (5.5 - 0.6) / 50 = 98\text{mV}$$

(i.e. full-scale linear range as measured on the sense resistor)

Efficiency and Power Dissipation

At high current levels, the I²R losses in R_{SENSE} can be significant. Consider this when choosing the resistor value and its power dissipation (wattage) rating. Also, the sense resistor value might drift if it is allowed to heat up excessively. The precision V_{OS} of MAX44286 allows to sense very low current using small sense resistors that reduce power dissipation and reduce hot spots. Dynamic range of the current that can be sensed is improved with low V_{OS} and low sense resistors.

Kelvin Connections

Because of the high currents that flow through R_{SENSE} , take care to eliminate parasitic trace resistance from causing errors in the sense voltage. Either use a four terminal current-sense resistor or use Kelvin (force and sense) PCB layout techniques. This is very important layout practice for any ultra-precision current-sense amplifiers. As shown in the [Typical Application Circuit](#), parasitic trace resistance is eliminated by measuring the drop across sense resistor right across its terminals.

Optional Output Filter Capacitor

When designing a system that uses a sample-and-hold stage in the ADC, the sampling capacitor momentarily loads OUT and causes a drop in the output voltage. If sampling time is very short (less than a microsecond), consider using a ceramic capacitor across OUT and GND to hold V_{OUT} constant during sampling. This also decreases the small-signal bandwidth of the current-sense amplifier and reduces noise at OUT.

Bidirectional Application

Battery-powered systems may require a precise bidirectional current-sense amplifier to accurately monitor the battery's charge and discharge currents. Measurements of the two MAX44286 separate outputs with respect to GND yield an accurate measure of the charge and discharge currents ([Figure 1](#)).

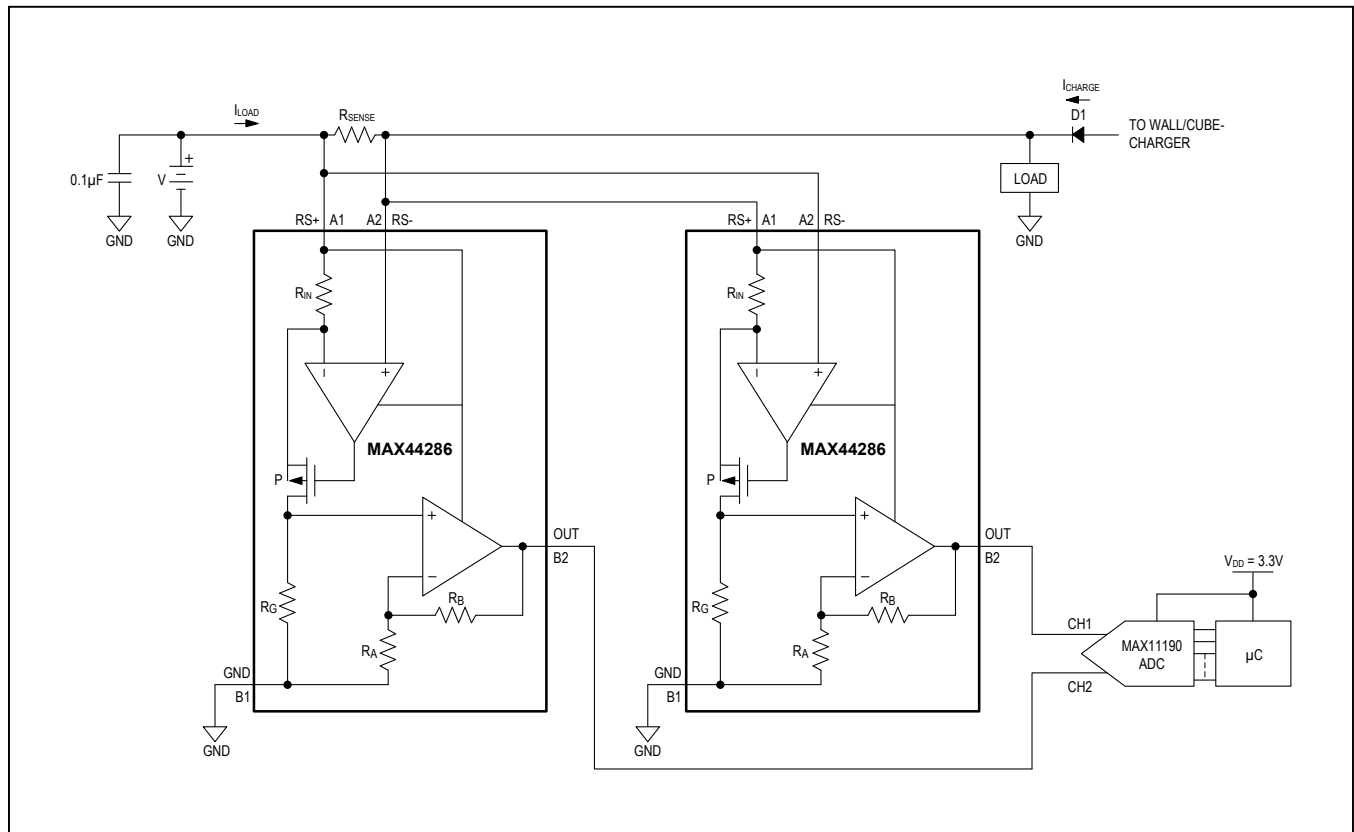

Figure 1. Bidirectional Application

MAX44286

Low-Power, Precision, 4-Bump WLP, Current-Sense Amplifier

Ordering Information

PART	TEMP RANGE	PIN-PACKAGE	GAIN (V/V)
MAX44286TAZS+	-40°C to +125°C	4 WLP	25
MAX44286FAZS+	-40°C to +125°C	4 WLP	50
MAX44286HAZS+	-40°C to +125°C	4 WLP	100
MAX44286WAZS+	-40°C to +125°C	4 WLP	200

+Denotes a lead(Pb)-free/RoHS-compliant package.

Chip Information

PROCESS: CMOS

Package Information

For the latest package outline information and land patterns (footprints), go to www.maximintegrated.com/packages. Note that a "+", "#", or "-" in the package code indicates RoHS status only. Package drawings may show a different suffix character, but the drawing pertains to the package regardless of RoHS status.

PACKAGE TYPE	PACKAGE CODE	OUTLINE NO.	LAND PATTERN NO.
4 WLP	Z40A0+1	21-0683	Refer to Application Note 1891

Revision History

REVISION NUMBER	REVISION DATE	DESCRIPTION	PAGES CHANGED
0	11/14	Initial release	—

For pricing, delivery, and ordering information, please contact Maxim Direct at 1-888-629-4642, or visit Maxim Integrated's website at www.maximintegrated.com.

Maxim Integrated cannot assume responsibility for use of any circuitry other than circuitry entirely embodied in a Maxim Integrated product. No circuit patent licenses are implied. Maxim Integrated reserves the right to change the circuitry and specifications without notice at any time. The parametric values (min and max limits) shown in the Electrical Characteristics table are guaranteed. Other parametric values quoted in this data sheet are provided for guidance.