



Chipsmall Limited consists of a professional team with an average of over 10 year of expertise in the distribution of electronic components. Based in Hongkong, we have already established firm and mutual-benefit business relationships with customers from,Europe,America and south Asia,supplying obsolete and hard-to-find components to meet their specific needs.

With the principle of “Quality Parts,Customers Priority,Honest Operation,and Considerate Service”,our business mainly focus on the distribution of electronic components. Line cards we deal with include Microchip,ALPS,ROHM,Xilinx,Pulse,ON,Everlight and Freescale. Main products comprise IC,Modules,Potentiometer,IC Socket,Relay,Connector.Our parts cover such applications as commercial,industrial, and automotives areas.

We are looking forward to setting up business relationship with you and hope to provide you with the best service and solution. Let us make a better world for our industry!



Contact us

Tel: +86-755-8981 8866 Fax: +86-755-8427 6832

Email & Skype: info@chipsmall.com Web: www.chipsmall.com

Address: A1208, Overseas Decoration Building, #122 Zhenhua RD., Futian, Shenzhen, China





Ultra-Small, Low-Cost, 210MHz, Single-Supply Op Amps with Rail-to-Rail Outputs

General Description

The MAX4450 single and MAX4451 dual op amps are unity-gain-stable devices that combine high-speed performance with rail-to-rail outputs. Both devices operate from a +4.5V to +11V single supply or from $\pm 2.25V$ to $\pm 5.5V$ dual supplies. The common-mode input voltage range extends beyond the negative power-supply rail (ground in single-supply applications).

The MAX4450/MAX4451 require only 6.5mA of quiescent supply current per op amp while achieving a 210MHz -3dB bandwidth and a 485V/ μ s slew rate. Both devices are an excellent solution in low-power/low-voltage systems that require wide bandwidth, such as video, communications, and instrumentation.

The MAX4450 is available in the ultra-small 5-pin SC70 package, while the MAX4451 is available in space-saving 8-pin SOT23 and SO packages.

Applications

Set-Top Boxes
Surveillance Video Systems
Battery-Powered Instruments
Video Line Driver
Analog-to-Digital Converter Interface
CCD Imaging Systems
Video Routing and Switching Systems
Digital Cameras

Typical Operating Circuit

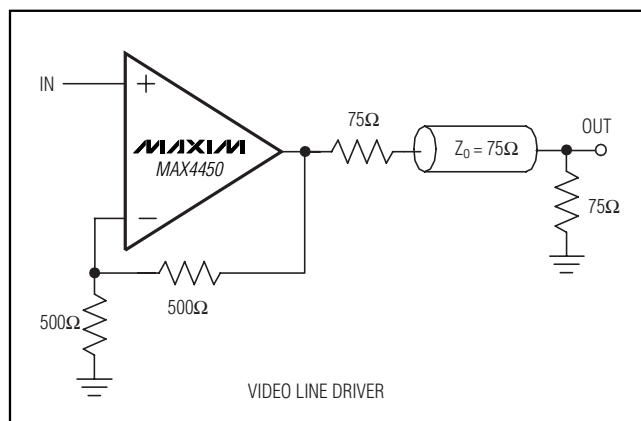

Features

- ◆ Ultra-Small SC705 and SOT23 Packages
- ◆ Low Cost
- ◆ High Speed
 - 210MHz -3dB Bandwidth
 - 55MHz 0.1dB Gain Flatness
 - 485V/ μ s Slew Rate
- ◆ Single +4.5V to +11V Operation
- ◆ Rail-to-Rail Outputs
- ◆ Input Common-Mode Range Extends Beyond VEE
- ◆ Low Differential Gain/Phase: 0.02%/0.08°
- ◆ Low Distortion at 5MHz
 - 65dBc SFDR
 - 63dB Total Harmonic Distortion

Ordering Information

| PART | TEMP RANGE | PIN-PACKAGE | TOP MARK |
|--------------|----------------|-------------|----------|
| MAX4450EXK-T | -40°C to +85°C | 5 SC70 | AAA |
| MAX4450EUK-T | -40°C to +85°C | 5 SOT23 | ADKP |
| MAX4451EKA-T | -40°C to +85°C | 8 SOT23 | AAAA |
| MAX4451ESA | -40°C to +85°C | 8 SO | — |

Pin Configurations

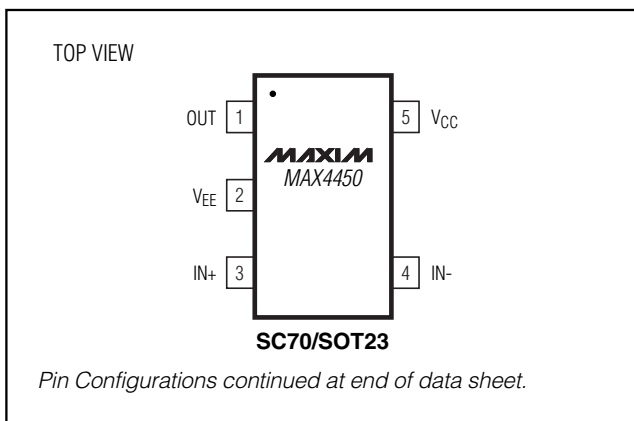

Ultra-Small, Low-Cost, 210MHz, Single-Supply Op Amps with Rail-to-Rail Outputs

ABSOLUTE MAXIMUM RATINGS

| | | | |
|--|--|---|-----------------|
| Supply Voltage (V_{CC} to V_{EE})..... | +12V | 8-Pin SOT23-8 (derate 5.26mW/°C above +70°C)..... | 421mW |
| IN_- , IN_+ , OUT_+ | ($V_{EE} - 0.3V$) to ($V_{CC} + 0.3V$) | 8-Pin SO (derate 5.9mW/°C above +70°C)..... | 471mW |
| Output Short-Circuit Current to V_{CC} or V_{EE} | 150mA | Operating Temperature Range | -40°C to +85°C |
| Continuous Power Dissipation ($T_A = +70^\circ C$) | | Storage Temperature Range | -65°C to +150°C |
| 5-Pin SC70-5 (derate 2.5mW/°C above +70°C)..... | 200mW | Lead Temperature (soldering, 10s) | +300°C |
| 5-Pin SOT23-5 (derate 7.1mW/°C above +70°C)..... | 571mW | | |

Stresses beyond those listed under "Absolute Maximum Ratings" may cause permanent damage to the device. These are stress ratings only, and functional operation of the device at these or at any other conditions beyond those indicated in the operational sections of the specifications is not implied. Exposure to absolute maximum rating conditions for extended periods may affect device reliability.

DC ELECTRICAL CHARACTERISTICS

($V_{CC} = +5V$, $V_{EE} = 0V$, $R_L = \infty$ to $V_{CC}/2$, $V_{OUT} = V_{CC}/2$, $T_A = T_{MIN}$ to T_{MAX} , unless otherwise noted. Typical values are at $T_A = +25^\circ C$.) (Note 1)

| PARAMETER | SYMBOL | CONDITIONS | MIN | TYP | MAX | UNITS |
|--|------------|---|--------------------------------|-----------|-----------------|------------------|
| Input Common-Mode Voltage Range | V_{CM} | Guaranteed by CMRR test | $V_{EE} - 0.20$ | | $V_{CC} - 2.25$ | V |
| Input Offset Voltage (Note 2) | V_{OS} | | | 4 | 26 | mV |
| Input Offset Voltage Matching | | | | 1.0 | | mV |
| Input Offset Voltage Temperature Coefficient | TC_{VOS} | | | 8 | | $\mu V/^\circ C$ |
| Input Bias Current | I_B | (Note 2) | | 6.5 | 20 | μA |
| Input Offset Current | I_{OS} | (Note 2) | | 0.5 | 4 | μA |
| Input Resistance | R_{IN} | Differential mode ($-1V \leq V_{IN} \leq +1V$) | | 70 | | k Ω |
| | | Common mode ($-0.2V \leq V_{CM} \leq +2.75V$) | | 3 | | M Ω |
| Common-Mode Rejection Ratio | CMRR | ($V_{EE} - 0.2V$) $\leq V_{CM} \leq (V_{CC} - 2.25V)$ | 70 | 95 | | dB |
| Open-Loop Gain (Note 2) | A_{VOL} | $0.25V \leq V_{OUT} \leq 4.75V$, $R_L = 2k\Omega$ | 50 | 60 | | dB |
| | | $0.5V \leq V_{OUT} \leq 4.5V$, $R_L = 150\Omega$ | 48 | 58 | | |
| | | $1V \leq V_{OUT} \leq 4V$, $R_L = 50\Omega$ | | 57 | | |
| Output Voltage Swing (Note 2) | V_{OUT} | $R_L = 2k\Omega$ | $V_{CC} - V_{OH}$ | 0.05 | 0.20 | V |
| | | | $V_{OL} - V_{EE}$ | 0.05 | 0.15 | |
| | | $R_L = 150\Omega$ | $V_{CC} - V_{OH}$ | 0.30 | 0.50 | |
| | | | $V_{OL} - V_{EE}$ | 0.25 | 0.80 | |
| | | $R_L = 75\Omega$ | $V_{CC} - V_{OH}$ | 0.5 | 0.80 | |
| | | | $V_{OL} - V_{EE}$ | 0.5 | 1.75 | |
| Output Current | I_{OUT} | $R_L = 50\Omega$ | Sourcing | 45 | 70 | mA |
| | | | Sinking | 25 | 50 | |
| Output Short-Circuit Current | I_{SC} | Sinking or sourcing | | ± 120 | | mA |
| Open-Loop Output Resistance | R_{OUT} | | | 8 | | Ω |
| Power-Supply Rejection Ratio (Note 3) | PSRR | $V_{CC} = 5V$ | $V_{EE} = 0V$, $V_{CM} = 2V$ | 46 | 62 | dB |
| | | | $V_{EE} = -5V$, $V_{CM} = 0V$ | 54 | 69 | |
| Operating Supply-Voltage Range | V_S | V_{CC} to V_{EE} | 4.5 | | 11.0 | V |
| Quiescent Supply Current (per amplifier) | I_S | | | 6.5 | 9.0 | mA |

Ultra-Small, Low-Cost, 210MHz, Single-Supply Op Amps with Rail-to-Rail Outputs

MAX4450/MAX4451

AC ELECTRICAL CHARACTERISTICS

($V_{CC} = +5V$, $V_{EE} = 0V$, $V_{CM} = +2.5V$, $R_F = 24\Omega$, $R_L = 100\Omega$ to $V_{CC}/2$, $V_{OUT} = V_{CC}/2$, $A_{VCL} = +1V/V$, $T_A = +25^\circ C$, unless otherwise noted.)

| PARAMETER | SYMBOL | CONDITIONS | MIN | TYP | MAX | UNITS |
|--|---------------------------------|--|---------------------------|------|-----|-----------------|
| Small-Signal -3dB Bandwidth | BW _{SS} | $V_{OUT} = 100mV_{P-P}$ | | 210 | | MHz |
| Large-Signal -3dB Bandwidth | BW _{LS} | $V_{OUT} = 2V_{P-P}$ | | 175 | | MHz |
| Bandwidth for 0.1dB Gain Flatness | BW _{0.1dB} | $V_{OUT} = 100mV_{P-P}$ | | 55 | | MHz |
| Slew Rate | SR | $V_{OUT} = 2V$ step | | 485 | | V/ μ s |
| Settling Time to 0.1% | t _S | $V_{OUT} = 2V$ step | | 16 | | ns |
| Rise/Fall Time | t _R , t _F | $V_{OUT} = 100mV_{P-P}$ | | 4 | | ns |
| Spurious-Free Dynamic Range | SFDR | $f_C = 5MHz$, $V_{OUT} = 2V_{P-P}$ | | -65 | | dBc |
| Harmonic Distortion | HD | $f_C = 5MHz$, $V_{OUT} = 2V_{P-P}$ | 2nd harmonic | -65 | | dBc |
| | | | 3rd harmonic | -58 | | |
| | | | Total harmonic distortion | -63 | | |
| Two-Tone, Third-Order Intermodulation Distortion | IP3 | $f_1 = 4.7MHz$, $f_2 = 4.8MHz$, $V_{OUT} = 1V_{P-P}$ | | 66 | | dBc |
| Channel-to-Channel Isolation | CH _{ISO} | Specified at DC | | 102 | | dB |
| Input 1dB Compression Point | | $f_C = 10MHz$, $A_{VCL} = +2V/V$ | | 14 | | dBm |
| Differential Phase Error | DP | NTSC, $R_L = 150\Omega$ | | 0.08 | | degrees |
| Differential Gain Error | DG | NTSC, $R_L = 150\Omega$ | | 0.02 | | % |
| Input Noise-Voltage Density | e _n | $f = 10kHz$ | | 10 | | nV/ \sqrt{Hz} |
| Input Noise-Current Density | i _n | $f = 10kHz$ | | 1.8 | | pA/ \sqrt{Hz} |
| Input Capacitance | C _{IN} | | | 1 | | pF |
| Output Impedance | Z _{OUT} | $f = 10MHz$ | | 1.5 | | Ω |

Note 1: All devices are 100% production tested at $T_A = +25^\circ C$. Specifications over temperature limits are guaranteed by design.

Note 2: Tested with $V_{CM} = +2.5V$.

Note 3: PSR for single +5V supply tested with $V_{EE} = 0V$, $V_{CC} = +4.5V$ to $+5.5V$; PSR for dual $\pm 5V$ supply tested with $V_{EE} = -4.5V$ to $-5.5V$, $V_{CC} = +4.5V$ to $+5.5V$.

Ultra-Small, Low-Cost, 210MHz, Single-Supply Op Amps with Rail-to-Rail Outputs

Typical Operating Characteristics

($V_{CC} = +5V$, $V_{EE} = 0V$, $V_{CM} = +2.5V$, $A_{VCL} = +1V/V$, $R_F = 24\Omega$, $R_L = 100\Omega$ to $V_{CC}/2$, $T_A = +25^\circ C$, unless otherwise noted.)

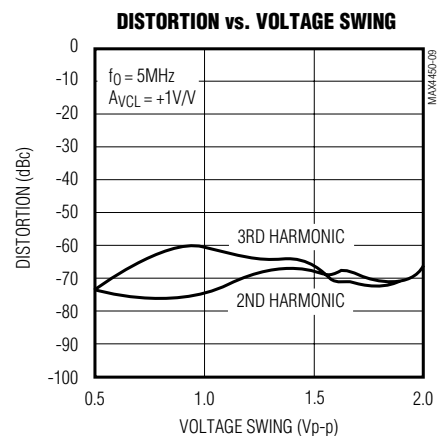
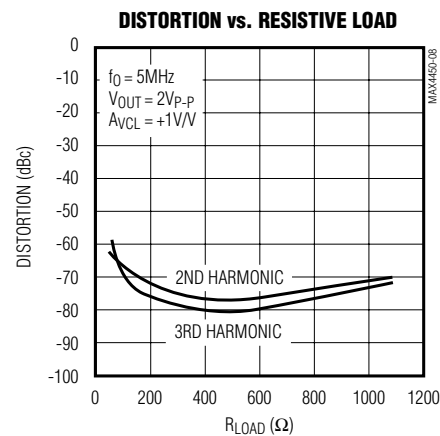
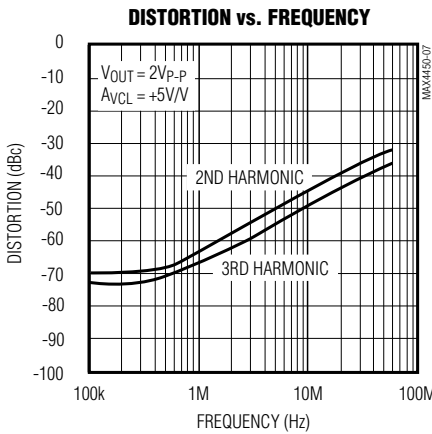
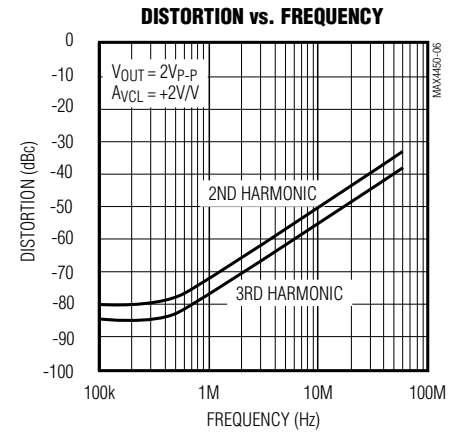
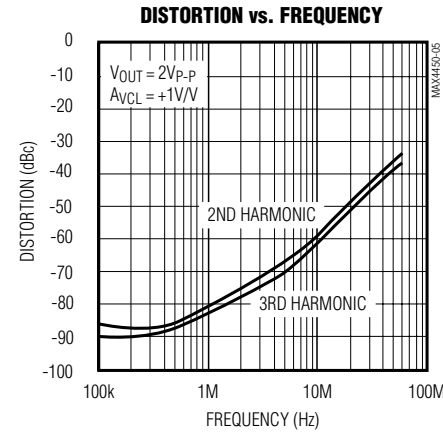
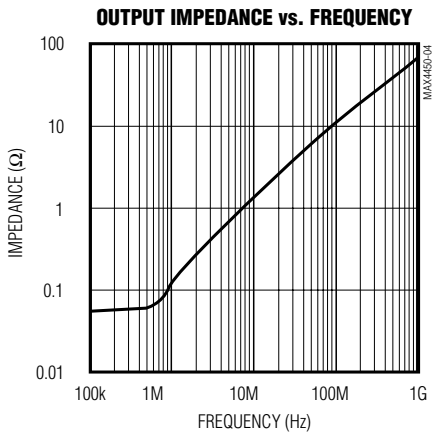
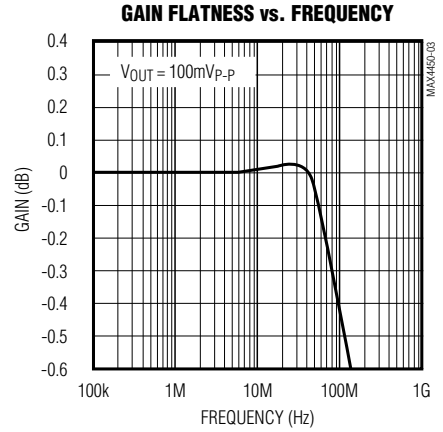
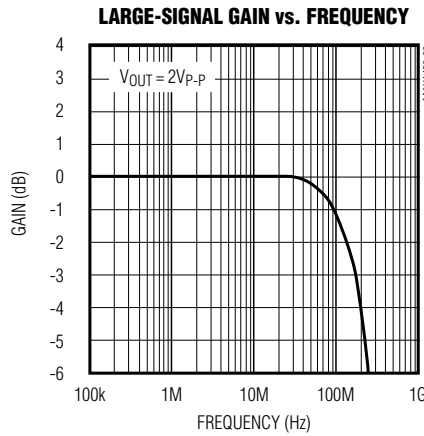
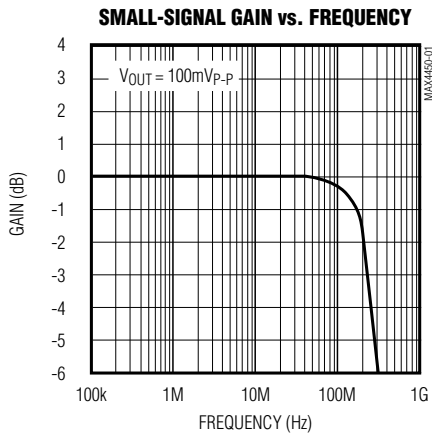

Ultra-Small, Low-Cost, 210MHz, Single-Supply Op Amps with Rail-to-Rail Outputs

Typical Operating Characteristics (continued)

($V_{CC} = +5V$, $V_{EE} = 0$, $V_{CM} = +2.5V$, $A_{VCL} = +1V/V$, $R_F = 24\Omega$, $R_L = 100\Omega$ to $V_{CC}/2$, $T_A = +25^\circ C$, unless otherwise noted.)

MAX4450/MAX4451

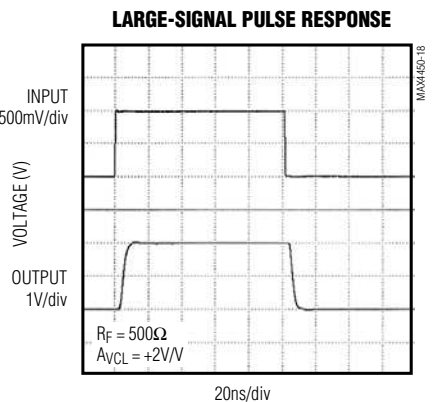
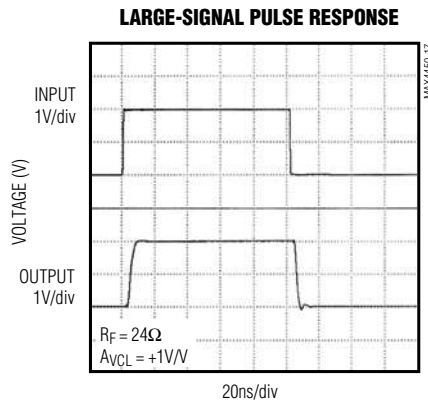
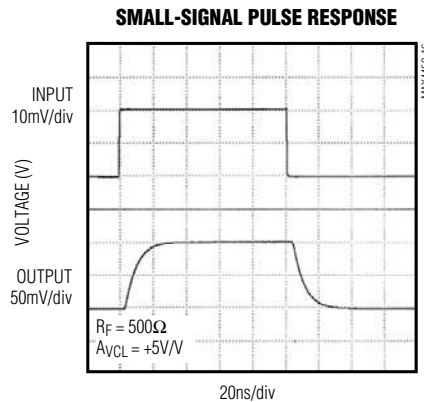
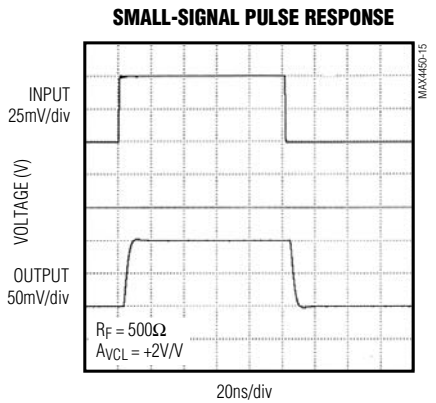
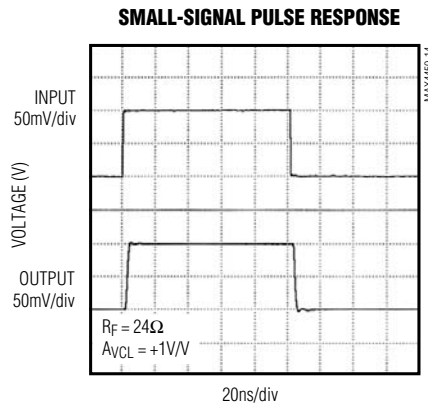
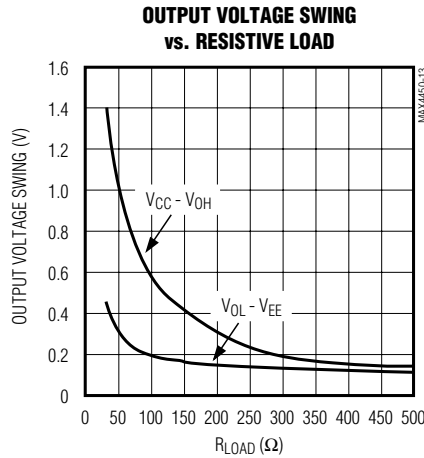
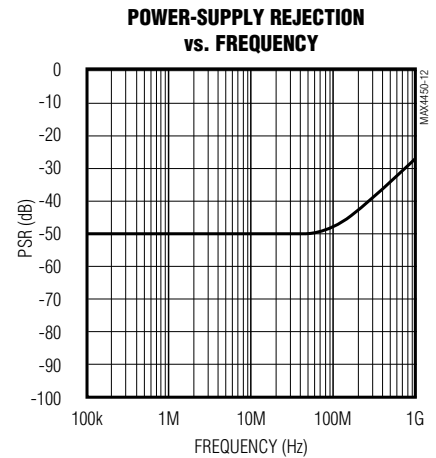
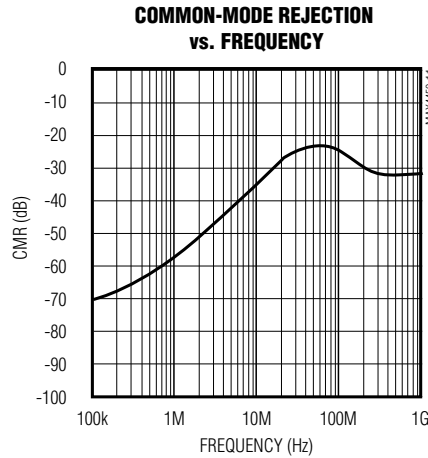
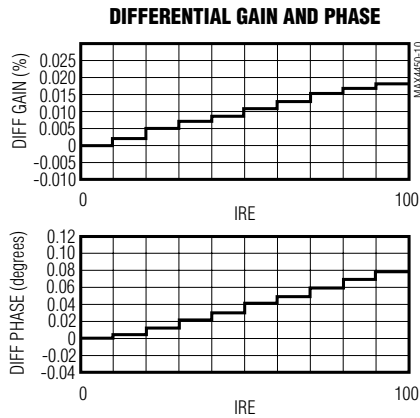

Ultra-Small, Low-Cost, 210MHz, Single-Supply Op Amps with Rail-to-Rail Outputs

Typical Operating Characteristics (continued)

($V_{CC} = +5V$, $V_{EE} = 0$, $V_{CM} = +2.5V$, $A_{VCL} = +1V/V$, $R_F = 24\Omega$, $R_L = 100\Omega$ to $V_{CC}/2$, $T_A = +25^\circ C$, unless otherwise noted.)

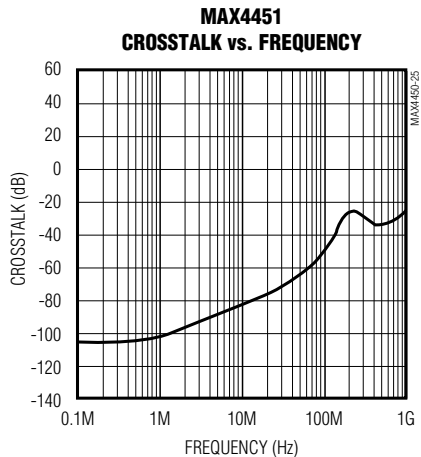
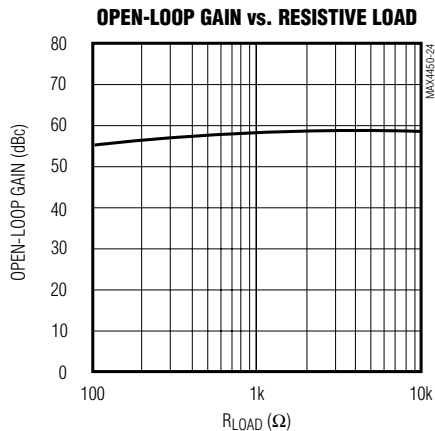
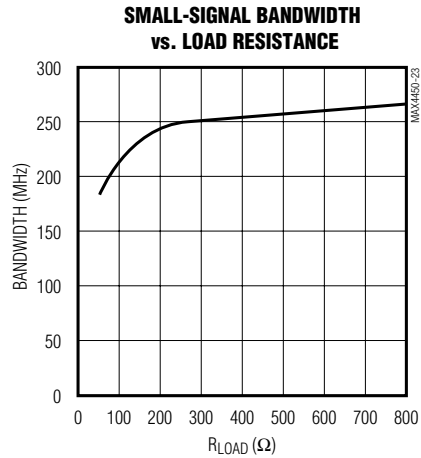
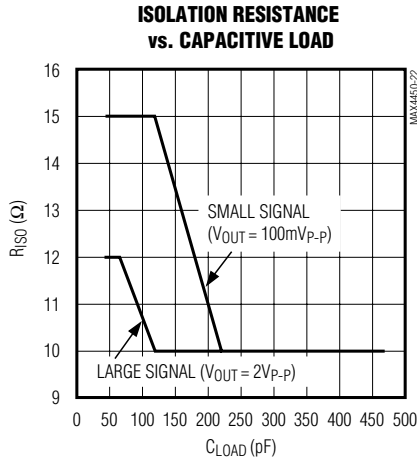
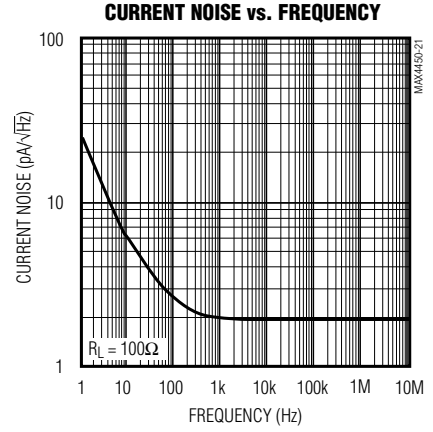
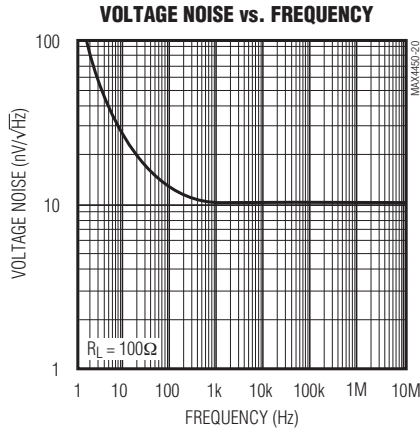
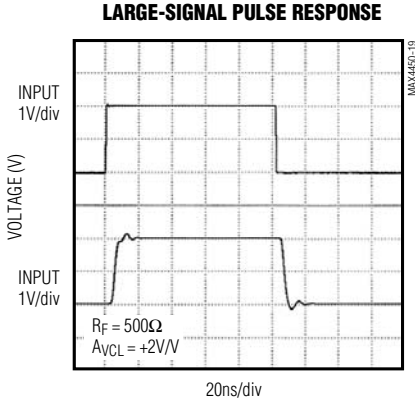

Ultra-Small, Low-Cost, 210MHz, Single-Supply Op Amps with Rail-to-Rail Outputs

MAX4450/MAX4451

Pin Description

| PIN | | NAME | FUNCTION |
|---------|---------|------|--|
| MAX4450 | MAX4451 | | |
| 1 | — | OUT | Amplifier Output |
| 2 | 4 | VEE | Negative Power Supply or Ground (in single-supply operation) |
| 3 | — | IN+ | Noninverting Input |
| 4 | — | IN- | Inverting Input |
| 5 | 8 | VCC | Positive Power Supply |
| — | 1 | OUTA | Amplifier A Output |
| — | 2 | INA- | Amplifier A Inverting Input |
| — | 3 | INA+ | Amplifier A Noninverting Input |
| — | 7 | OUTB | Amplifier B Output |
| — | 6 | INB- | Amplifier B Inverting Input |
| — | 5 | INB+ | Amplifier B Noninverting Input |

Detailed Description

The MAX4450/MAX4451 are single-supply, rail-to-rail, voltage-feedback amplifiers that employ current-feedback techniques to achieve 485V/μs slew rates and 210MHz bandwidths. Excellent harmonic distortion and differential gain/phase performance make these amplifiers an ideal choice for a wide variety of video and RF signal-processing applications.

The output voltage swings to within 55mV of each supply rail. Local feedback around the output stage ensures low open-loop output impedance to reduce gain sensitivity to load variations. The input stage permits common-mode voltages beyond the negative supply and to within 2.25V of the positive supply rail.

Applications Information

Choosing Resistor Values

Unity-Gain Configuration

The MAX4450/MAX4451 are internally compensated for unity gain. When configured for unity gain, the devices require a 24Ω resistor (R_F) in series with the feedback path. This resistor improves AC response by reducing the Q of the parallel LC circuit formed by the parasitic feedback capacitance and inductance.

Inverting and Noninverting Configurations

Select the gain-setting feedback (R_F) and input (R_G) resistor values to fit your application. Large resistor values increase voltage noise and interact with the amplifier's input and PC board capacitance. This can generate undesirable poles and zeros and decrease bandwidth or cause oscillations. For example, a noninverting gain-of-two configuration (R_F = R_G) using 1kΩ resistors, combined with 1pF of amplifier input capacitance and 1pF of PC board capacitance, causes a pole at 159MHz. Since this pole is within the amplifier bandwidth, it jeopardizes stability. Reducing the 1kΩ resistors to 100Ω extends the pole frequency to 1.59GHz, but could limit output swing by adding 200Ω in parallel with the amplifier's load resistor. Table 1 lists suggested feedback and gain resistors, and bandwidths for several gain values in the configurations shown in Figures 1a and 1b.

Layout and Power-Supply Bypassing

These amplifiers operate from a single +4.5V to +11V power supply or from dual ±2.25V to ±5.5V supplies. For single-supply operation, bypass VCC to ground with a

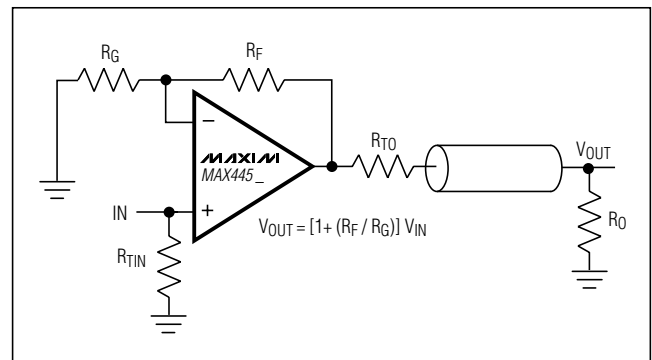

Figure 1a. Noninverting Gain Configuration

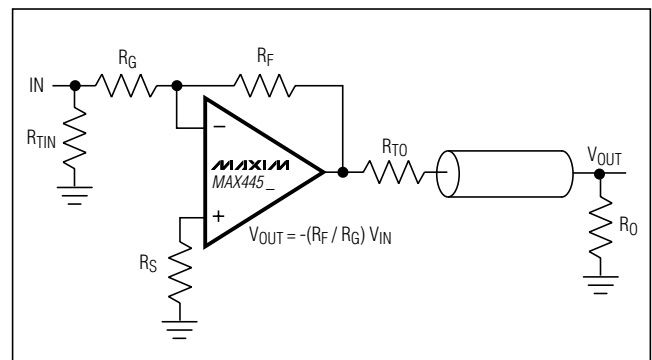

Figure 1b. Inverting Gain Configuration

Ultra-Small, Low-Cost, 210MHz, Single-Supply Op Amps with Rail-to-Rail Outputs

Table 1. Recommended Component Values

| COMPONENT | GAIN (V/V) | | | | | | | | | |
|-----------------------------------|------------|------|------|------|------|------|------|------|------|------|
| | +1 | -1 | +2 | -2 | +5 | -5 | +10 | -10 | +25 | -25 |
| R _F (Ω) | 24 | 500 | 500 | 500 | 500 | 500 | 500 | 500 | 500 | 1200 |
| R _G (Ω) | ∞ | 500 | 500 | 250 | 124 | 100 | 56 | 50 | 20 | 50 |
| R _S (Ω) | — | 0 | — | 0 | — | 0 | — | 0 | — | 0 |
| R _{TIN} (Ω) | 49.9 | 56 | 49.9 | 62 | 49.9 | 100 | 49.9 | ∞ | 49.9 | ∞ |
| R _{TO} (Ω) | 49.9 | 49.9 | 49.9 | 49.9 | 49.9 | 49.9 | 49.9 | 49.9 | 49.9 | 49.9 |
| Small-Signal -3dB Bandwidth (MHz) | 210 | 100 | 95 | 50 | 25 | 25 | 11 | 15 | 5 | 10 |

Note: $R_L = R_O + R_{TO}$; R_{TIN} and R_{TO} are calculated for 50Ω applications. For 75Ω systems, $R_{TO} = 75Ω$; calculate R_{TIN} from the following equation:

$$R_{TIN} = \frac{75}{1 - \frac{75}{R_G}} \Omega$$

0.1μF capacitor as close to the pin as possible. If operating with dual supplies, bypass each supply with a 0.1μF capacitor.

Maxim recommends using microstrip and stripline techniques to obtain full bandwidth. To ensure that the PC board does not degrade the amplifier's performance, design it for a frequency greater than 1GHz. Pay careful attention to inputs and outputs to avoid large parasitic capacitance. Whether or not you use a constant-impedance board, observe the following design guidelines:

- Don't use wire-wrap boards; they are too inductive.
- Don't use IC sockets; they increase parasitic capacitance and inductance.
- Use surface-mount instead of through-hole components for better high-frequency performance.
- Use a PC board with at least two layers; it should be as free from voids as possible.
- Keep signal lines as short and as straight as possible. Do not make 90° turns; round all corners.

Rail-to-Rail Outputs, Ground-Sensing Input

The input common-mode range extends from (V_{EE} - 200mV) to (V_{CC} - 2.25V) with excellent common-mode rejection. Beyond this range, the amplifier output is a nonlinear function of the input, but does not undergo phase reversal or latching.

The output swings to within 55mV of either power-supply rail with a 2kΩ load. The input ground sensing

and the rail-to-rail output substantially increase the dynamic range. With a symmetric input in a single +5V application, the input can swing 2.95V_{P-P} and the output can swing 4.9V_{P-P} with minimal distortion.

Output Capacitive Loading and Stability

The MAX4450/MAX4451 are optimized for AC performance. They are not designed to drive highly reactive loads, which decrease phase margin and may produce excessive ringing and oscillation. Figure 2 shows a circuit that eliminates this problem. Figure 3 is a graph of the optimal isolation resistor (R_S) vs. capacitive load. Figure 4 shows how a capacitive load causes excessive peaking of the amplifier's frequency response if the capacitor is not isolated from the amplifier by a resistor. A small isolation resistor (usually 20Ω to 30Ω) placed before the reactive load prevents ringing and oscillation. At higher capacitive loads, AC performance is controlled by the interaction of the load capacitance and the isolation resistor. Figure 5 shows the effect of a 27Ω isolation resistor on closed-loop response.

Coaxial cable and other transmission lines are easily driven when properly terminated at both ends with their characteristic impedance. Driving back-terminated transmission lines essentially eliminates the line's capacitance.

Ultra-Small, Low-Cost, 210MHz, Single-Supply Op Amps with Rail-to-Rail Outputs

MAX4450/MAX4451

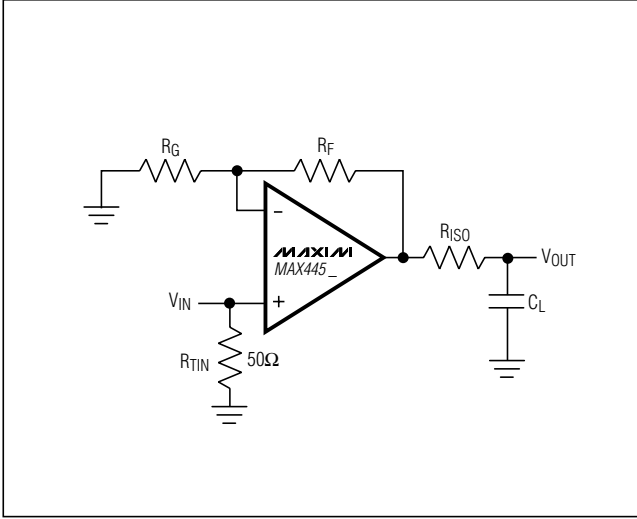

Figure 2. Driving a Capacitive Load Through an Isolation Resistor

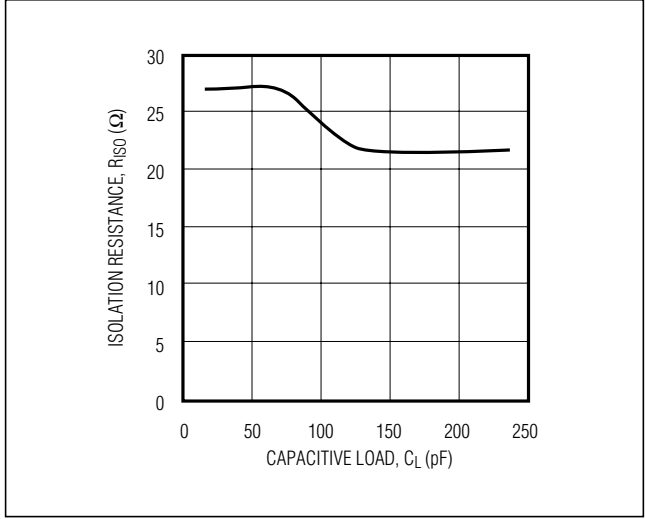

Figure 3. Capacitive Load vs. Isolation Resistance

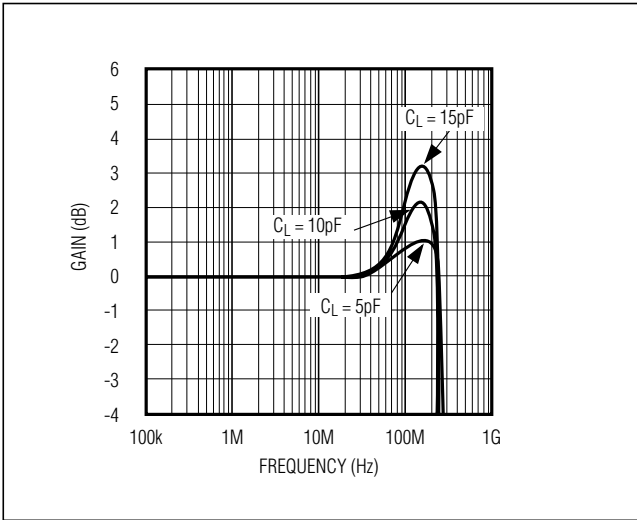

Figure 4. Small-Signal Gain vs. Frequency with Load Capacitance and No Isolation Resistor

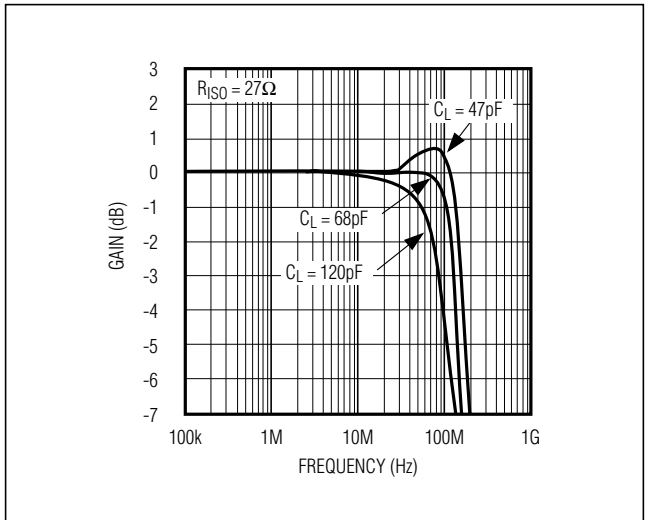
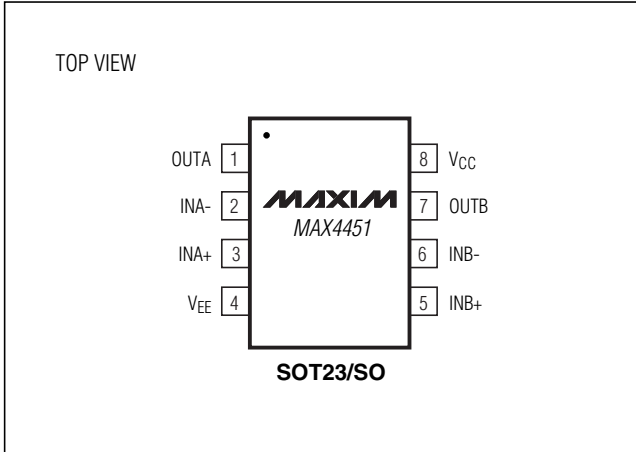

Figure 5. Small-Signal Gain vs. Frequency with Load Capacitance and 27Ω Isolation Resistor

Ultra-Small, Low-Cost, 210MHz, Single-Supply Op Amps with Rail-to-Rail Outputs

Pin Configurations (continued)

Chip Information



MAX4450 TRANSISTOR COUNT: 86

MAX4451 TRANSISTOR COUNT: 170

Ultra-Small, Low-Cost, 210MHz, Single-Supply Op Amps with Rail-to-Rail Outputs

Package Information

For the latest package outline information and land patterns, go to www.maxim-ic.com/packages. Note that a "+", "#", or "-" in the package code indicates RoHS status only. Package drawings may show a different suffix character, but the drawing pertains to the package regardless of RoHS status.

| PACKAGE TYPE | PACKAGE CODE | DOCUMENT NO. |
|--------------|--------------|-------------------------|
| 5 SC70 | X5-1 | 21-0076 |
| 5 SOT23 | U5-2 | 21-0057 |
| 8 SOT23 | K8-2 | 21-0078 |
| 8 SO | S8-5 | 21-0041 |

MAX4450/MAX4451

| COMMON DIMENSIONS | | | |
|-------------------|------------|------|------|
| SYMBOL | MIN | NOM | MAX |
| A | 0.80 | 0.95 | 1.10 |
| A1 | 0.00 | 0.07 | 0.10 |
| A2 | 0.80 | 0.90 | 1.00 |
| b | 0.15 | 0.22 | 0.30 |
| c | 0.10 | 0.14 | 0.18 |
| D | 1.80 | 2.00 | 2.20 |
| e | 0.65 BSC. | | |
| E | 1.15 | 1.25 | 1.35 |
| HE | 1.80 | 2.20 | 2.40 |
| L | 0.26 | 0.34 | 0.46 |
| L1 | 0.425 TYP. | | |
| Q1 | 0.10 | 0.25 | 0.40 |
| PKG. CODE | X5-1 | | |

NOTES:
 1. ALL DIMENSIONS ARE IN MILLIMETERS.
 2. DIMENSIONS ARE INCLUSIVE OF PLATING.
 3. DIMENSIONS ARE EXCLUSIVE OF MOLD FLASH & METAL BURR.
 4. COMPLY TO JEITA SC-88A EXCEPT FOR DIMENSION "L". ALL DIMENSIONS COMPLY TO JEDEC MO-203.
 5. COPLANARITY 4 MILS. MAX.
 6. FOOT LENGTH MEASURED AT INTERCEPT POINT BETWEEN DATUM "A" AND LEAD SURFACE.
 7. MARKING IS FOR PACKAGE ORIENTATION REFERENCE ONLY.
 8. LEAD CENTERLINES TO BE AT TRUE POSITION AS DEFINED BY BASIC DIMENSION "e", ±0.05.

DALLAS SEMICONDUCTOR **MAXIM**

TITLE: PACKAGE OUTLINE, 5L SC70

| | | | |
|----------|---------------------------------|-----------|-----|
| APPROVAL | DOCUMENT CONTROL NO. 21-0076 | REV. E | 1/1 |
|----------|---------------------------------|-----------|-----|

-DRAWING NOT TO SCALE-

Ultra-Small, Low-Cost, 210MHz, Single-Supply Op Amps with Rail-to-Rail Outputs

Package Information (continued)

For the latest package outline information and land patterns, go to www.maxim-ic.com/packages. Note that a "+", "#", or "-" in the package code indicates RoHS status only. Package drawings may show a different suffix character, but the drawing pertains to the package regardless of RoHS status.

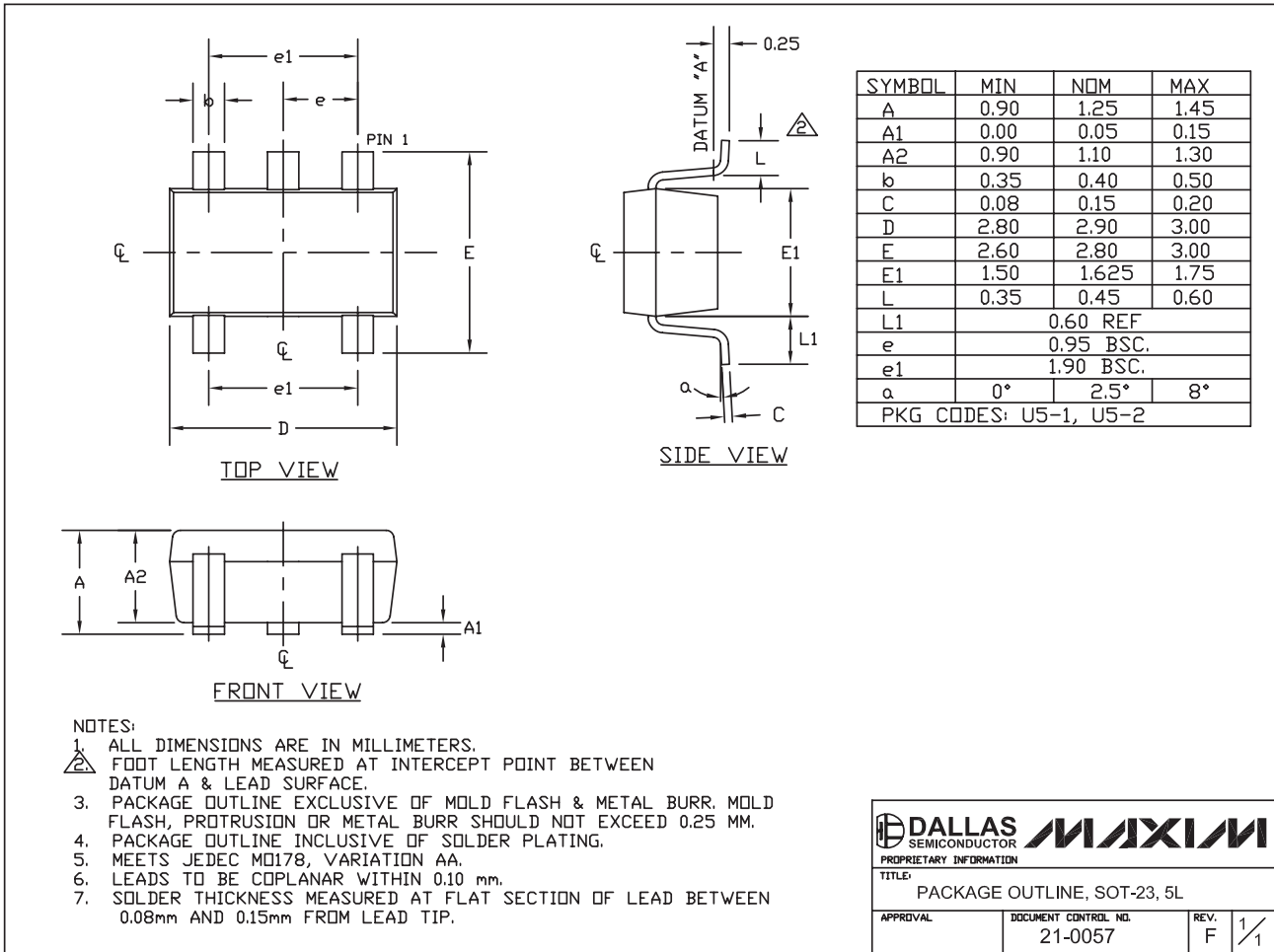

SOT-23 5L .EPS

Ultra-Small, Low-Cost, 210MHz, Single-Supply Op Amps with Rail-to-Rail Outputs

Package Information (continued)

For the latest package outline information and land patterns, go to www.maxim-ic.com/packages. Note that a "+", "#", or "-" in the package code indicates RoHS status only. Package drawings may show a different suffix character, but the drawing pertains to the package regardless of RoHS status.

MAX4450/MAX4451

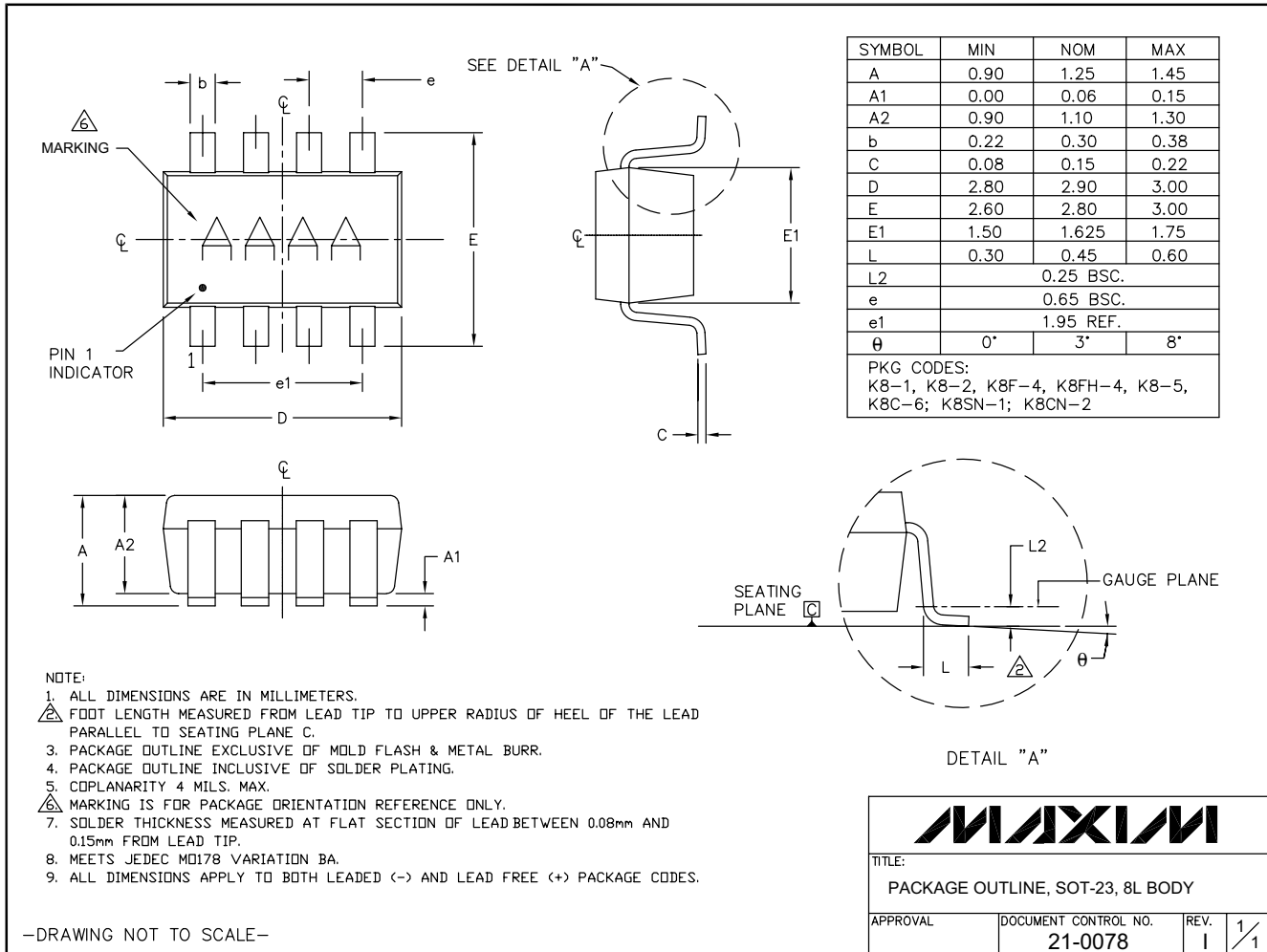

Ultra-Small, Low-Cost, 210MHz, Single-Supply Op Amps with Rail-to-Rail Outputs

Package Information (continued)

For the latest package outline information and land patterns, go to www.maxim-ic.com/packages. Note that a "+", "#", or "-" in the package code indicates RoHS status only. Package drawings may show a different suffix character, but the drawing pertains to the package regardless of RoHS status.

SOICN .EPS

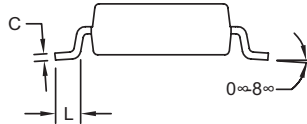
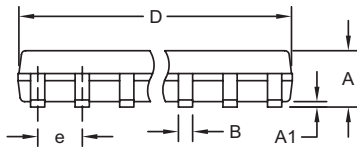
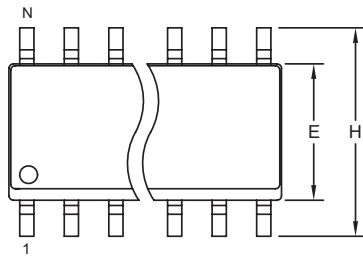

| DIM | INCHES | | MILLIMETERS | |
|-----|-----------|-------|-------------|------|
| | MIN | MAX | MIN | MAX |
| A | 0.053 | 0.069 | 1.35 | 1.75 |
| A1 | 0.004 | 0.010 | 0.10 | 0.25 |
| B | 0.014 | 0.019 | 0.35 | 0.49 |
| C | 0.007 | 0.010 | 0.19 | 0.25 |
| e | 0.050 BSC | | 1.27 BSC | |
| E | 0.150 | 0.157 | 3.80 | 4.00 |
| H | 0.228 | 0.244 | 5.80 | 6.20 |
| L | 0.016 | 0.050 | 0.40 | 1.27 |

VARIATIONS:

| DIM | INCHES | | MILLIMETERS | | N | MS012 |
|-----|--------|-------|-------------|-------|----|-------|
| | MIN | MAX | MIN | MAX | | |
| D | 0.189 | 0.197 | 4.80 | 5.00 | 8 | AA |
| D | 0.337 | 0.344 | 8.55 | 8.75 | 14 | AB |
| D | 0.386 | 0.394 | 9.80 | 10.00 | 16 | AC |

NOTES:

1. D&E DO NOT INCLUDE MOLD FLASH.
2. MOLD FLASH OR PROTRUSIONS NOT TO EXCEED 0.15mm (.006").
3. LEADS TO BE COPLANAR WITHIN 0.10mm (.004").
4. CONTROLLING DIMENSION: MILLIMETERS.
5. MEETS JEDEC MS012.
6. N = NUMBER OF PINS.

| | |
|--|---------------------------------|
| | |
| <small>PROPRIETARY INFORMATION</small> | |
| TITLE: PACKAGE OUTLINE, .150" SOIC | |
| APPROVAL | DOCUMENT CONTROL NO. 21-0041 |
| REV. | B 1/1 |

Ultra-Small, Low-Cost, 210MHz, Single-Supply Op Amps with Rail-to-Rail Outputs

Revision History

| REVISION NUMBER | REVISION DATE | DESCRIPTION | PAGES CHANGED |
|-----------------|---------------|------------------|---------------|
| 4 | 11/09 | Corrected TOC 20 | 6 |

Maxim cannot assume responsibility for use of any circuitry other than circuitry entirely embodied in a Maxim product. No circuit patent licenses are implied. Maxim reserves the right to change the circuitry and specifications without notice at any time.

15 _____ **Maxim Integrated Products, 120 San Gabriel Drive, Sunnyvale, CA 94086 408-737-7600**