



Chipsmall Limited consists of a professional team with an average of over 10 year of expertise in the distribution of electronic components. Based in Hongkong, we have already established firm and mutual-benefit business relationships with customers from,Europe,America and south Asia,supplying obsolete and hard-to-find components to meet their specific needs.

With the principle of “Quality Parts,Customers Priority,Honest Operation,and Considerate Service”,our business mainly focus on the distribution of electronic components. Line cards we deal with include Microchip,ALPS,ROHM,Xilinx,Pulse,ON,Everlight and Freescale. Main products comprise IC,Modules,Potentiometer,IC Socket,Relay,Connector.Our parts cover such applications as commercial,industrial, and automotives areas.

We are looking forward to setting up business relationship with you and hope to provide you with the best service and solution. Let us make a better world for our industry!



## Contact us

Tel: +86-755-8981 8866 Fax: +86-755-8427 6832

Email & Skype: info@chipsmall.com Web: www.chipsmall.com

Address: A1208, Overseas Decoration Building, #122 Zhenhua RD., Futian, Shenzhen, China



EVALUATION KIT  
AVAILABLE**MAXIM**

# Serially Controlled, Dual 4x2, Clickless Audio/Video Analog Crosspoint Switches

## General Description

The MAX4550/MAX4570 serial-interface, programmable, dual 4x2 audio/video crosspoint switches are ideal for multimedia applications. Each device contains two identical crosspoint switch arrays, each with four inputs and two outputs. To improve off-isolation, use the additional crosspoint inputs SA and SB as shunts. Each output is selectively programmable for clickless or regular mode operation. A set of internal resistive voltage-dividers supplies DC bias for each output when using AC-coupled inputs. Additionally, four auxiliary outputs control additional circuitry via the MAX4550/MAX4570's 2-wire or 3-wire interface.

The MAX4550/MAX4570 feature 80Ω on-resistance, 10Ω on-resistance matching between channels, 5Ω on-resistance flatness, and 0.014% total harmonic distortion. Additionally, they feature off-isolation of at least -110dB in the audio frequency range and -78dB at 4MHz, with -95dB crosstalk in the audio frequency range and -54dB at 4MHz. The MAX4550 uses a 2-wire I<sup>2</sup>C-compatible serial interface, while the MAX4570 uses a 3-wire SPI™/QSPI™ or MICROWIRE™-compatible serial interface. These parts are available in 28-pin SSOP and wide SO packages and are tested over either the commercial (0°C to +70°C) or extended (-40°C to +85°C) operating temperature range.

## Applications

Set-Top Boxes  
PC Multimedia Boards  
High-End Audio Systems  
Video Conferencing Systems

## Ordering Information

PART	TEMP. RANGE	PIN-PACKAGE
MAX4550CAI	0°C to +70°C	28 SSOP
MAX4550CWI	0°C to +70°C	28 Wide SO
MAX4550EAI	-40°C to +85°C	28 SSOP
MAX4550EWI	-40°C to +85°C	28 Wide SO
MAX4570CAI	0°C to +70°C	28 SSOP
MAX4570CWI	0°C to +70°C	28 Wide SO
MAX4570EAI	-40°C to +85°C	28 SSOP
MAX4570EWI	-40°C to +85°C	28 Wide SO

I<sup>2</sup>C is a trademark of Philips Corp.

SPI/QSPI are trademarks of Motorola, Inc.

MICROWIRE is a trademark of National Semiconductor Corp.

## Features

- ◆ Selectable Soft Switching Mode for Clickless Audio Operation
- ◆ 43Ω Typical On-Resistance (±5V Supplies)
- ◆ 5Ω Typical On-Resistance Matching Between Channels
- ◆ 4Ω Typical On-Resistance Flatness
- ◆ 0.014% Total Harmonic Distortion with 1kΩ Load
- ◆ -110dB Off-Isolation at 20kHz  
-78dB Off-Isolation at 4MHz
- ◆ -95dB Crosstalk at 20kHz  
-54dB Crosstalk at 4MHz
- ◆ Serial Interface  
2-Wire, Fast-Mode, I<sup>2</sup>C-Compatible (MAX4550)  
3-Wire, SPI/QSPI/MICROWIRE-Compatible (MAX4570)
- ◆ Four Auxiliary Outputs that Extend μP Ports
- ◆ Single-Supply Operation: +2.7V to +5.5V  
Dual-Supply Operation: ±2.7V to ±5.5V

## Pin Configuration

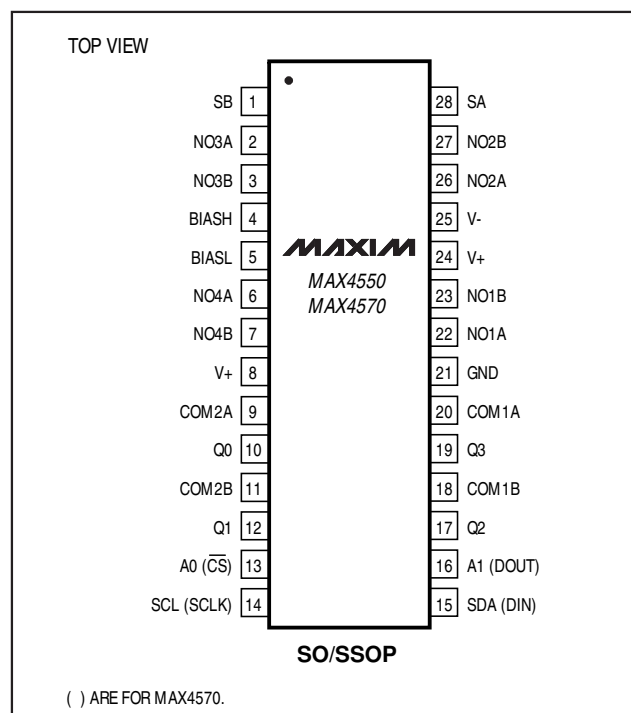

Functional Diagram appears at end of data sheet.

MAX4550/MAX4570

**MAXIM**

Maxim Integrated Products 1

For free samples & the latest literature: <http://www.maxim-ic.com>, or phone 1-800-998-8800.  
For small orders, phone 1-800-835-8769.



# Serially Controlled, Dual 4x2, Clickless Audio/Video Analog Crosspoint Switches

## ABSOLUTE MAXIMUM RATINGS

V+ to GND	-0.3V to +6V
V+ to V-	-0.3V to +13.2V
V- to GND	+0.3V to -6V
NO__, S_, BIAS_, COM__, Q_, A1, DOUT to GND (Note 1)	(V- - 0.3V) to (V+ + 0.3V)
CS, SCLK, DIN, SCL, SDA, A0 to GND	-0.3V to +6V
Continuous Current into Any Terminal	±10mA
Peak Current, NO__, S_, COM__ (pulsed at 1ms, 10% duty cycle max)	±40mA

Continuous Power Dissipation (TA = +70°C)	
28-Pin SSOP (derate 9.52mW/°C above +70°C)	762mW
28-Pin Wide SO (derate 12.5mW/°C above +70°C)	1000mW
Operating Temperature Ranges	
MAX4550C_I/MAX4570C_I	-0°C to +70°C
MAX4550E_I/MAX4570E_I	-40°C to +85°C
Storage Temperature Range	-65°C to +160°C
Lead Temperature (soldering, 10sec)	+300°C

**Note 1:** Signals on NO\_\_, S\_ or COM\_\_ exceeding V+ or V- are clamped by internal diodes. Limit forward-diode current to maximum current rating.

Stresses beyond those listed under "Absolute Maximum Ratings" may cause permanent damage to the device. These are stress ratings only, and functional operation of the device at these or any other conditions beyond those indicated in the operational sections of the specifications is not implied. Exposure to absolute maximum rating conditions for extended periods may affect device reliability.

## ANALOG ELECTRICAL CHARACTERISTICS—Dual Supplies

(V+ = +5V ±5%, V- = -5V ±5%, TA = TMIN to TMAX, unless otherwise noted. Typical values are at TA = +25°C.) (Note 2)

PARAMETER	SYMBOL	CONDITIONS	MIN	TYP	MAX	UNITS	
<b>ANALOG SWITCHES</b>							
Analog Signal Range (Note 3)	VNO__, VCOM__, VS_		V-		V+	V	
On-Resistance	RON	ICOM__ = 4mA, VNO__ or VS_ = ±3.0V, V+ = 4.75V, V- = -4.75V	TA = +25°C	43	80	Ω	
			TA = TMIN to TMAX		100		
COM__ to NO__ or S_ On-Resistance Match Between Channels (Note 4)	ΔRON	ICOM__ = 4mA, VNO__ or VS_ = ±3.0V, V+ = 4.75V, V- = -4.75V	TA = +25°C	5	10	Ω	
			TA = TMIN to TMAX		10		
COM__ to NO__ or S_ On-Resistance Flatness (Note 5)	ΔRFLAT(ON)	ICOM__ = 4mA; VNO__ or VS_ = ±3.0V, 0; V+ = 4.75V; V- = -4.75V	TA = +25°C	4	5	Ω	
			TA = TMIN to TMAX		8		
NO__ or S_ Off-Leakage Current (Note 6)	NO_(OFF)	VNO__ or VS_ = ±4.5V, VCOM__ = ∓4.5V, V+ = 5.25V, V- = -5.25V	TA = +25°C	-1	0.01	1	nA
			TA = TMIN to TMAX	-10		10	
COM__ Off-Leakage Current (Note 6)	ICOM_(OFF)	VNO__ or VS_ = ±4.5V, VCOM__ = ∓4.5V, V+ = 5.25V, V- = -5.25V	TA = +25°C	-5	0.01	5	nA
			TA = TMIN to TMAX	-10		10	
COM__ On-Leakage Current (Note 6)	ICOM_(ON)	VNO__ or VS_ = floating, VCOM__ = ±4.5V, V+ = 5.25V, V- = -5.25V	TA = +25°C	-5	0.01	5	nA
			TA = TMIN to TMAX	-20		20	
<b>AUDIO PERFORMANCE</b>							
Total Harmonic Distortion plus Noise	THD+N	fIN = 1kHz, RL = 1kΩ, VNO_ or VS_ = 1VRMS, VNO_ or VS_ = 0		0.014		%	
Off-Isolation (Note 7)	VISO(A)	VNO = 1VRMS, fIN = 20kHz, RL = 10kΩ, S = GND	Shunt switch on	-110		dB	
			Shunt switch off	-80			
Channel-to-Channel Crosstalk	VCTA(A)	VNO__ or VS_ = 1VRMS, fIN = 20kHz, RL = 10kΩ, three channels driven at 20kHz		-95		dB	

# Serially Controlled, Dual 4x2, Clickless Audio/Video Analog Crosspoint Switches

MAX4550/MAX4570

## ANALOG ELECTRICAL CHARACTERISTICS—Dual Supplies (continued)

(V+ = +5V ±5%, V- = -5V ±5%, TA = TMIN to TMAX, unless otherwise noted. Typical values are at TA = +25°C.) (Note 2)

PARAMETER	SYMBOL	CONDITIONS	MIN	TYP	MAX	UNITS			
<b>VIDEO PERFORMANCE</b>									
Off-Isolation	VISO(V)	VNO__ or VS_ = 1VRMS, fIN = 4MHz, RL = 1kΩ, S_ = GND	Shunt switch on		-78	dB			
			Shunt switch off		-63				
Channel-to-Channel Crosstalk	VCT(V)	VNO__ or VS_ = 1VRMS, fIN = 4MHz, RL = 10Ω, three channels driven at 4MHz			-54	dB			
0.1dB Bandwidth	BW	RS = 75Ω, RL = 1kΩ			14	MHz			
Off-Capacitance	COFF(NO)	fIN = 1MHz,			11	pF			
<b>DYNAMIC TIMING WITH CLICKLESS MODE DISABLED (Note 8)</b>									
Turn-On Time (Note 9)	tONSD	VNO__ or VS_ = 1.5V, RL = 5kΩ			400	900	ns		
Turn-Off Time (Note 9)	tOFFSD	VNO__ or VS_ = 1.5V, RL = 300Ω			200	500	ns		
Break-Before-Make Time	tBBM	VNO__ or VS_ = 1.5V	10	100			ns		
<b>DYNAMIC TIMING WITH CLICKLESS MODE ENABLED (Note 8, Figure 5)</b>									
Turn-On Time	TONSE	VNO__ or VS_ = 1.5V, RL = 5kΩ			36			ms	
Turn-Off Time	TOFFSE	VNO__ or VS_ = 1.5V, RL = 300Ω			11			ms	
<b>BIAS NETWORKS</b>									
Bias Network Resistance	RBIAS	BIASH to BIASL	13	20	27			kΩ	
<b>POWER SUPPLIES</b>									
Supply Voltage Range	V+			2.7	5.25	V			
	V-			-5.25	0				
V+ Supply Current (Note 10)	I+	Reset condition, V+ = 2.7V to 5.25V		7	20			μA	
V- Supply Current	I-	Reset condition, V- = -5.25V to 0				-20			μA

## ANALOG ELECTRICAL CHARACTERISTICS—Single +5V Supply

(V+ = +5V ±5%, V- = 0, TA = TMIN to TMAX, unless otherwise noted. Typical values are at TA = +25°C.) (Note 2)

PARAMETER	SYMBOL	CONDITIONS	MIN	TYP	MAX	UNITS	
<b>ANALOG SWITCHES</b>							
Analog Signal Range (Note 3)	VNO__, VCOM__, VS_			0	V+	V	
On-Resistance	RON	ICOM__ = 4mA, VNO__ or VS_ = 3.0V, V+ = 4.75V	TA = +25°C	60	100	Ω	
			TA = TMIN to TMAX	130			
On-Resistance Match Between Channels (Note 4)	ΔRON	ICOM__ = 4mA, VNO__ or VS_ = 3.0V, V+ = 4.75V	TA = +25°C	5	10	Ω	
			TA = TMIN to TMAX	10			
On-Resistance Flatness (Note 5)	RFLAT	ICOM__ = 4mA; VNO__ or VS_ = 1V, 2V, 3V; V+ = 4.75V	TA = +25°C	4	10	Ω	
			TA = TMIN to TMAX	15			
NO__ or S_ Off-Leakage Current (Notes 6, 11)	INO__(OFF)	VNO or VS_ = 4.5V, 1V; VCOM__ = 1V, 4.5V; V+ = 5.25V	TA = +25°C	-1	0.01	1	nA
			TA = TMIN to TMAX	-10	10		

# Serially Controlled, Dual 4x2, Clickless Audio/Video Analog Crosspoint Switches

## ANALOG ELECTRICAL CHARACTERISTICS—Single +5V Supply (continued)

(V<sub>+</sub> = +5V ±5%, V<sub>-</sub> = 0, T<sub>A</sub> = T<sub>MIN</sub> to T<sub>MAX</sub>, unless otherwise noted. Typical values are at T<sub>A</sub> = +25°C.) (Note 2)

PARAMETER	SYMBOL	CONDITIONS	MIN	TYP	MAX	UNITS	
COM__ Off-Leakage Current (Notes 6, 11)	I <sub>COM__(OFF)</sub>	V <sub>NO__</sub> or V <sub>S_</sub> = 4.5V, 1V; V <sub>COM__</sub> = 1V, 4.5V; V <sub>+</sub> = 5.25V	T <sub>A</sub> = +25°C	-5	0.01	5	nA
			T <sub>A</sub> = T <sub>MIN</sub> to T <sub>MAX</sub>	-10		10	
COM__ On-Leakage Current (Notes 6, 11)	I <sub>COM__(ON)</sub>	V <sub>NO__</sub> or V <sub>S_</sub> = floating; V <sub>COM__</sub> = 1V, 4.5V; V <sub>+</sub> = 5.25V	T <sub>A</sub> = +25°C	-5	0.01	5	nA
			T <sub>A</sub> = T <sub>MIN</sub> to T <sub>MAX</sub>	-20		20	
<b>AUDIO PERFORMANCE</b>							
Total Harmonic Distortion plus Noise	THD+N	f <sub>IN</sub> = 1kHz, R <sub>L</sub> = 10kΩ, V <sub>NO__</sub> or V <sub>S_</sub> = 1V <sub>RMS</sub> , V <sub>NO__</sub> or V <sub>S_</sub> = 2.5V		0.014		%	
Off-Isolation (Note 7)	V <sub>ISO(A)</sub>	V <sub>NO__</sub> or V <sub>S_</sub> = 1V <sub>RMS</sub> , f <sub>IN</sub> = 20kHz, R <sub>L</sub> = 10kΩ, S = GND	Shunt switch on	-105		dB	
			Shunt switch off	-80			
Channel-to-Channel Crosstalk	V <sub>TC(A)</sub>	V <sub>NO__</sub> or V <sub>S_</sub> = 1V <sub>RMS</sub> , f <sub>IN</sub> = 20kHz, R <sub>L</sub> = 10kΩ, three channels driven at 20kHz		-97		dB	
<b>VIDEO PERFORMANCE</b>							
Off-Isolation (Note 7)	V <sub>ISO(V)</sub>	V <sub>NO__</sub> or V <sub>S_</sub> = 1V <sub>RMS</sub> , f <sub>IN</sub> = 4MHz, R <sub>L</sub> = 1kΩ, S = GND	Shunt switch on	-74		dB	
			Shunt switch off	-61			
Channel-to-Channel Crosstalk	V <sub>TC(V)</sub>	V <sub>NO__</sub> or V <sub>S_</sub> = 1V <sub>RMS</sub> , f <sub>IN</sub> = 4MHz, R <sub>L</sub> = 10kΩ, three channels driven at 4MHz		-52		dB	
0.1dB Bandwidth	BW	R <sub>SOURCE</sub> = 75Ω, R <sub>L</sub> = 1kΩ		13		MHz	
Off-Capacitance	C <sub>OFF(NO)</sub>	f <sub>IN</sub> = 1MHz		11		pF	
<b>DYNAMIC TIMING WITH CLICKLESS MODE DISABLED (Note 8)</b>							
Turn-On Time (Note 9)	t <sub>ONSD</sub>	V <sub>NO__</sub> or V <sub>S_</sub> = 1.5V, R <sub>L</sub> = 5kΩ		400	900	ns	
Turn-Off Time (Note 9)	t <sub>OFFSD</sub>	V <sub>NO__</sub> or V <sub>S_</sub> = 1.5V, R <sub>L</sub> = 300Ω		160	500	ns	
Break-Before-Make Time	t <sub>BBM</sub>	V <sub>NO__</sub> or V <sub>S_</sub> = 1.5V	10	100		ns	
<b>DYNAMIC TIMING WITH CLICKLESS MODE ENABLED (Note 8, Figure 5)</b>							
Turn-On Time	t <sub>ONSE</sub>	V <sub>NO__</sub> or V <sub>S_</sub> = 1.5V, R <sub>L</sub> = 5kΩ		43		ms	
Turn-Off Time	t <sub>OFFSE</sub>	V <sub>NO__</sub> or V <sub>S_</sub> = 1.5V, R <sub>L</sub> = 300Ω		14		ms	
<b>BIAS NETWORKS</b>							
Bias Network Resistance	R <sub>BIAS</sub>	BIASH to BIASL	13	20	27	kΩ	

## ANALOG ELECTRICAL CHARACTERISTICS—Single +3V Supply

(V<sub>+</sub> = +3V ±10%, V<sub>-</sub> = 0, T<sub>A</sub> = T<sub>MIN</sub> to T<sub>MAX</sub>, unless otherwise noted. Typical values are at T<sub>A</sub> = +25°C.) (Note 2)

PARAMETER	SYMBOL	CONDITIONS	MIN	TYP	MAX	UNITS
<b>ANALOG SWITCHES</b>						
Analog Signal Range (Note 3)	V <sub>NO__</sub> , V <sub>COM__</sub> , V <sub>S_</sub>		0		V <sub>+</sub>	V
On-Resistance	R <sub>ON</sub>	I <sub>COM__</sub> = 4mA, V <sub>NO__</sub> or V <sub>S_</sub> = 1V, V <sub>+</sub> = 2.7V	T <sub>A</sub> = +25°C	106	180	Ω
			T <sub>A</sub> = T <sub>MIN</sub> to T <sub>MAX</sub>		220	

# Serially Controlled, Dual 4x2, Clickless Audio/Video Analog Crosspoint Switches

MAX4550/MAX4570

## INTERFACE I/O CHARACTERISTICS

(V+ = +2.7V to +5.5V, V- = 0 to -5.5V, TA = TMIN to TMAX, unless otherwise noted. Typical values are at TA = +25°C.) (Note 2)

PARAMETER	SYMBOL	CONDITIONS	MIN	TYP	MAX	UNITS
<b>AUXILIARY OUTPUTS</b>						
Output High Voltage	VOH	ISOURCE = 1mA to GND, V+ = 4.75V	4.45	4.65		V
		ISOURCE = 0.5mA to GND, V+ = 2.7V	2.3	2.5		
Output Low Voltage	VOL	ISINK = 6mA, V+ = 2.7V		0.5	1.0	V
		ISINK = 12mA, V+ = 4.75V		0.5	1.0	
<b>DIGITAL INPUTS (SCK, DIN, CS, SCL, SDA)</b>						
Input High Voltage	VIH	V+ > 3.6V	3.0			V
		V+ < 3.6V	2.0			
Input Low Voltage	VIL	V+ > 3.6V			0.8	V
		V+ < 3.6V			0.6	
Input Hysteresis	VHYST			0.2		V
Input Leakage Current (Note 7)	I <sub>LEAK</sub>	VNO__ = 0 or 5V	-1	0.01	1	μA
Input Capacitance	CNO			5		pF
<b>DIGITAL OUTPUTS (DOUT, SDA)</b>						
Output Low Voltage	VOL	ISINK = 6mA	V+ = 4.75V		0.4	V
			V+ = 2.7V		0.8	
DOUT Output High Voltage	VOH	ISOURCE = 0.5mA	V+ - 0.5	V+ - 0.1		V
<b>I<sup>2</sup>C TIMING (V+ = +4.75V to +5.25V, Figures 1, 2)</b>						
SCL Clock Frequency	fSCL		DC		400	kHz
Bus Free Time between Stop and Start Condition	tBUF		1.3			μs
STOP Condition Setup Time	tSU:STO		0.6			μs
Data Hold Time	tHD:DAT		0		0.9	μs
Data Setup Time	tSU:DAT		100			ns
Clock Low Period	tLOW		1.3			μs
Clock High Period	tHIGH		0.6			μs
SCL/SDA Rise Time (Note 12)	tR		20 + 0.1Cb		300	ns
SCL/SDA Fall Time (Note 12)	tF		20 + 0.1Cb		300	ns
<b>SPI TIMING (V+ = +4.75V to +5.25V, Figures 3, 4)</b>						
Operating Frequency	fOP		DC		2.1	MHz
DIN to SCLK Setup	fDS		100			ns
DIN to SCLK Hold	fDH				0	ns
SCLK Fall to Output Data Valid	fDO	CLOAD = 50pF	20		200	ns
CS to SCLK Rise Setup	fCSS		100			ns
CS to SCLK Rise Hold	fCSH		0			ns

# Serially Controlled, Dual 4x2, Clickless Audio/Video Analog Crosspoint Switches

## INTERFACE I/O CHARACTERISTICS (continued)

( $V_+ = +2.7V$  to  $+5.5V$ ,  $V_- = 0$  to  $-5.5V$ ,  $T_A = T_{MIN}$  to  $T_{MAX}$ , unless otherwise noted. Typical values are at  $T_A = +25^\circ C$ .) (Note 2)

PARAMETER	SYMBOL	CONDITIONS	MIN	TYP	MAX	UNITS
SCLK Pulse Width Low	$t_{CH}$		200			ns
SCLK Pulse Width High	$t_{CL}$		200			ns
Rise Time (SCLK, DIN, $\overline{CS}$ )	$t_R$				2.0	$\mu s$
Fall Time (SCLK, DIN, $\overline{CS}$ )	$t_F$				2.0	$\mu s$

**Note 2:** The algebraic convention is used in this data sheet; the most negative value is shown in the minimum column.

**Note 3:** Guaranteed by design. Not subject to production testing.

**Note 4:**  $\Delta R_{ON} = R_{ON(MAX)} - R_{ON(MIN)}$ .

**Note 5:** On-resistance flatness is defined as the difference between the maximum and minimum on-resistance values, as measured over the specified analog signal range.

**Note 6:** Leakage parameters are 100% tested at maximum rated temperature, and guaranteed by correlation at  $T_A = +25^\circ C$ .

**Note 7:** Off-isolation =  $20 \cdot \log(V_{COM\_} / V_{NO\_})$ ,  $V_{COM\_}$  = output,  $V_{NO\_}$  = input to off switch.

**Note 8:** All timing is measured from the clock's falling edge preceding the ACK signal for 2-wire, and from  $\overline{CS}$ 's rising edge for 3-wire. Turn-Off Time is defined as the output of the switch for 0.5V change, tested with a  $300\Omega$  load to ground. Turn-On Time is measured with a  $5k\Omega$  load resistor to GND. All timing is shown with respect to 20% of  $V_+$  and 70% of  $V_+$ , unless otherwise noted.

**Note 9:** Typical values are for MAX4570 only.

**Note 10:** Supply current can be as high as 2mA per switch during switch transitions in the clickless mode, corresponding to 40mA total supply transient current requirement.

**Note 11:** Leakage testing for single-supply operation is guaranteed by testing with dual supplies.

**Note 12:**  $C_b$  = capacitance of one bus line in pF. Tested with  $C_b = 400pF$ .

## Typical Operating Characteristics

( $T_A = +25^\circ C$ , unless otherwise noted.)

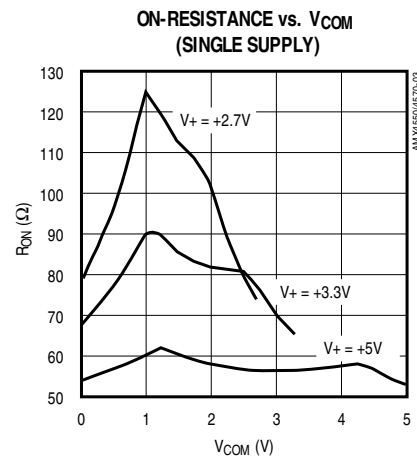
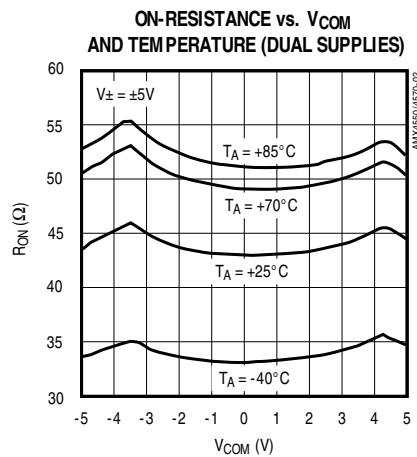
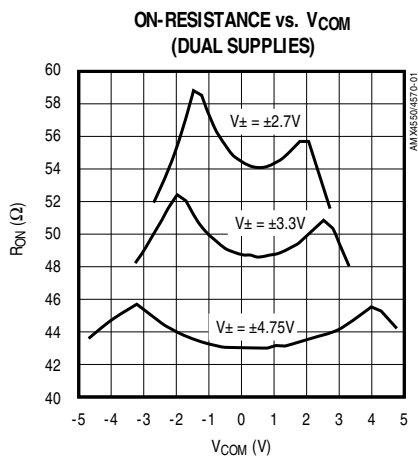

# Serially Controlled, Dual 4x2, Clickless Audio/Video Analog Crosspoint Switches

## Typical Operating Characteristics (continued)

( $T_A = +25^\circ\text{C}$ , unless otherwise noted.)

MAX4550/MAX4570

ON-RESISTANCE vs.  $V_{COM}$  AND TEMPERATURE (SINGLE SUPPLY)

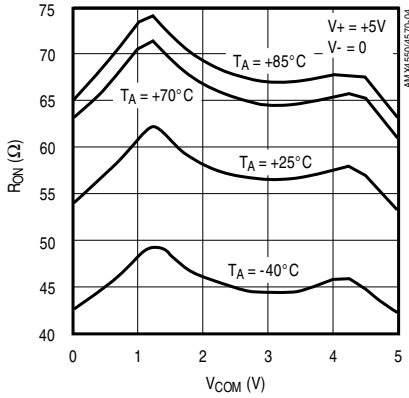

ON-RESISTANCE vs. TEMPERATURE

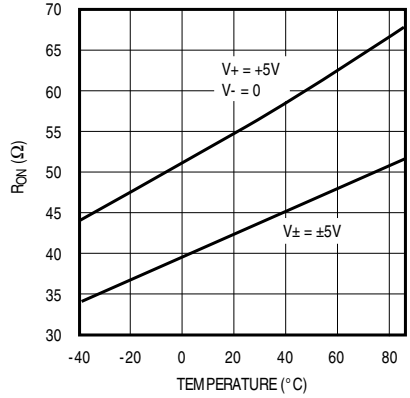

LEAKAGE CURRENT vs. TEMPERATURE

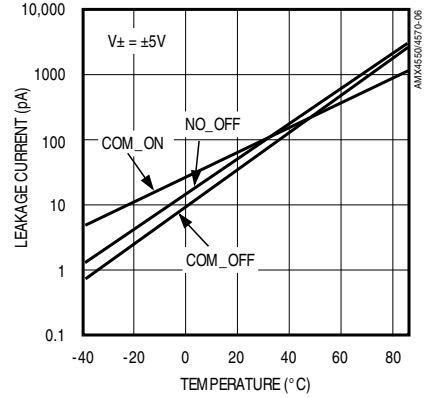

SUPPLY CURRENT vs. TEMPERATURE (DUAL SUPPLIES)

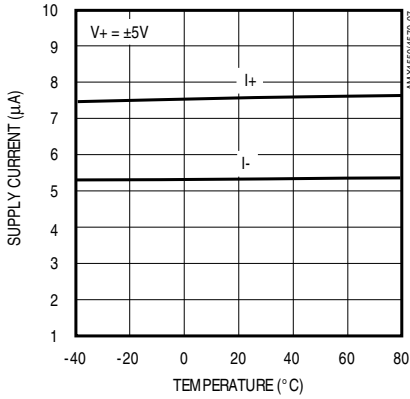

SUPPLY CURRENT vs. TEMPERATURE (SINGLE SUPPLY)

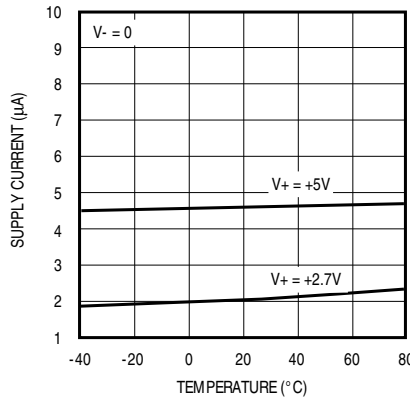

CHARGE INJECTION vs.  $V_{COM}$

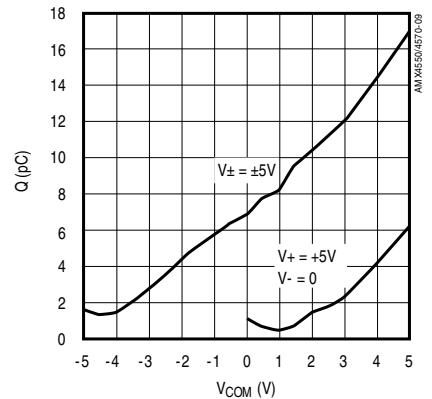

TURN-ON/TURN-OFF TIMES vs. SUPPLY VOLTAGE (DUAL SUPPLIES)

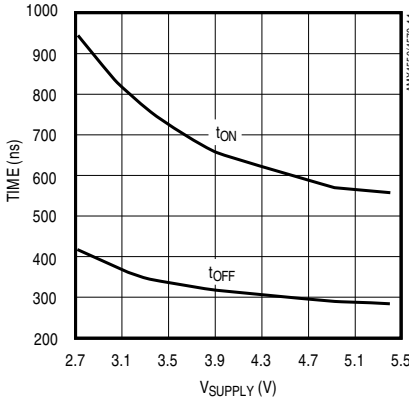

TURN-ON/TURN-OFF TIMES vs. SUPPLY VOLTAGE (SINGLE SUPPLY)

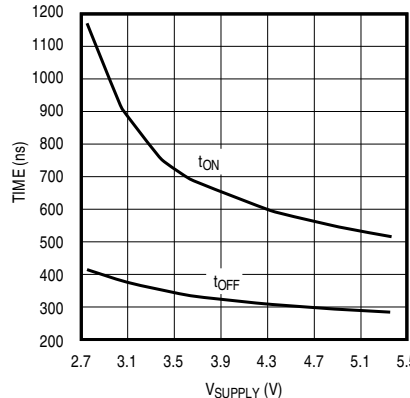

OFF-ISOLATION AND CROSSTALK vs. FREQUENCY

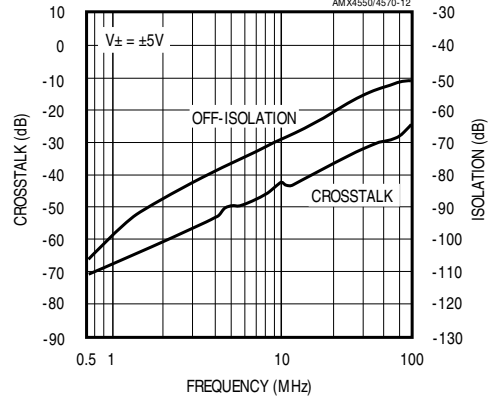



# Serially Controlled, Dual 4x2, Clickless Audio/Video Analog Crosspoint Switches

## Typical Operating Characteristics (continued)

( $T_A = +25^\circ\text{C}$ , unless otherwise noted.)

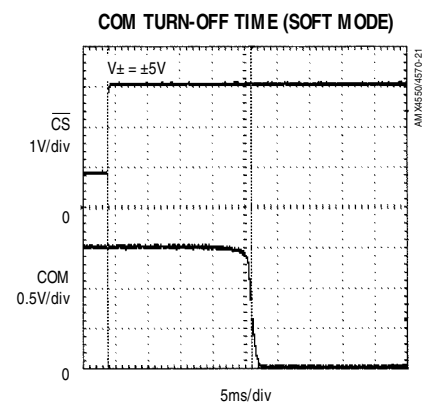
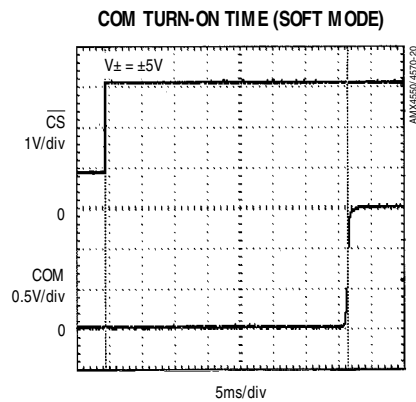
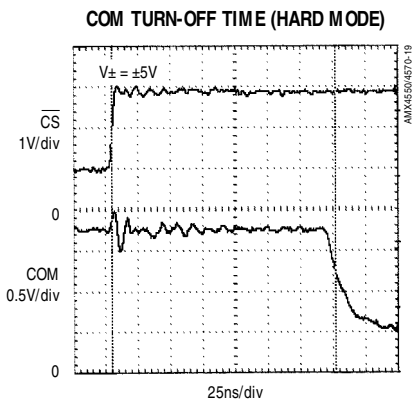
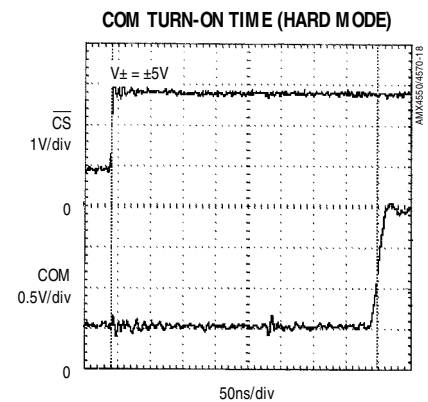
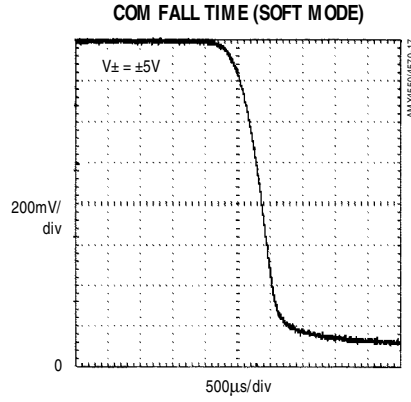
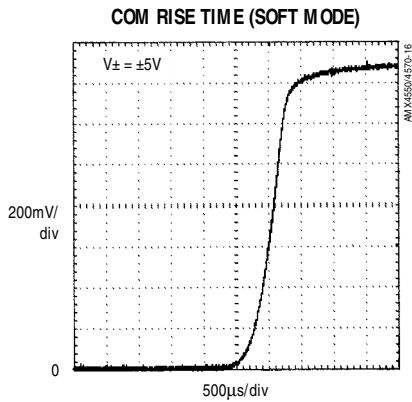
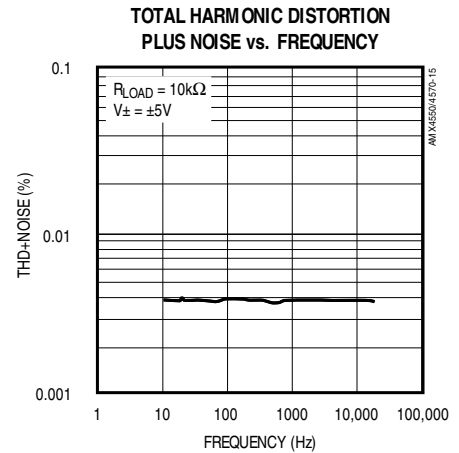
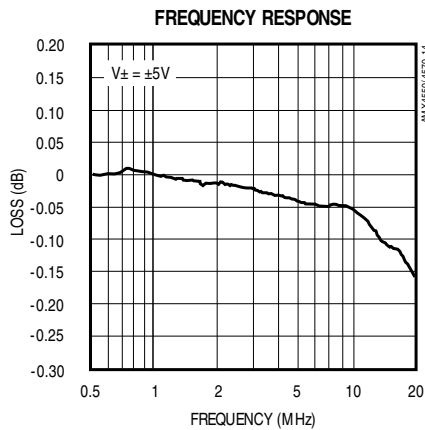
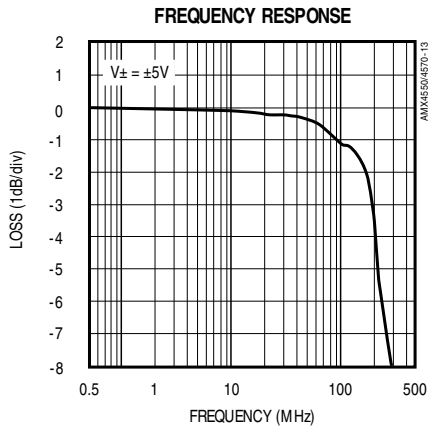

# Serially Controlled, Dual 4x2, Clickless Audio/Video Analog Crosspoint Switches

## Pin Description

MAX4550/MAX4570

PIN		NAME	FUNCTION
MAX4550	MAX4570		
1	1	SB	Shunt Input to Crosspoint B. Use for shunt capacitor or AC ground connection to improve off-isolation, or as an additional input to switch matrix B.
2	2	NO3A	Input 3 to Crosspoint A
3	3	NO3B	Input 3 to Crosspoint B
4	4	BIASH	High Side of Bias Network. Use to give the outputs a DC bias when inputs are AC-coupled (refer to the <i>Using the Internal Bias Resistors</i> section).
5	5	BIASL	Low Side of Bias Network. Use to give the outputs a DC bias when inputs are AC-coupled (refer to the <i>Using the Internal Bias Resistors</i> section).
6	6	NO4A	Input 4 to Crosspoint A
7	7	NO4B	Input 4 to Crosspoint B
8, 24	8, 24	V+	Positive Supply Voltage. Supply range is +2.7V to +5.25V. Connect pin 8 to pin 24 externally.
9	9	COM2A	Output 2 of Crosspoint A
10	10	Q0	Auxiliary Output 0
11	11	COM2B	Output 2 of Crosspoint B
12	12	Q1	Auxiliary Output 1
13	—	A0	LSB+1 of 2-Wire Serial-Interface Address Field
—	13	$\overline{CS}$	Chip Select of 3-Wire Interface. Logic low on $\overline{CS}$ enables serial data to be clocked in to device. Programming commands are executed on $\overline{CS}$ 's rising edge.
14	—	SCL	2-Wire Serial-Interface Clock Input
—	14	SCLK	3-Wire Serial-Interface Clock Input
15	—	SDA	2-Wire Serial-Interface Data Input. Data is clocked in on SCL's rising edge.
—	15	DIN	3-Wire Serial-Interface Data Input. Data is clocked in on SCLK's rising edge.
16	—	A1	LSB+2 of 2-Wire Serial-Interface Address Field
—	16	DOUT	Data Output of 3-Wire Interface. Input data is clocked out and SCLK's falling edge delayed by 16 clock cycles. DOUT remains active when $\overline{CS}$ is high.
17	17	Q2	Auxiliary Output 2
18	18	COM1B	Output 1 of Crosspoint A
19	19	Q3	Auxiliary Output 3
20	20	COM1A	Output 1 of Crosspoint A
21	21	GND	Ground
22	22	NO1A	Input 1 to Crosspoint A
23	23	NO1B	Input 1 to Crosspoint B
25	25	V-	Negative Supply Voltage. Supply range is from -5.25V to 0.
26	26	NO2A	Input 2 to Crosspoint A
27	27	NO2B	Input 2 to Crosspoint B
28	28	SA	Shunt Input to Crosspoint A. Use for shunt capacitor or AC ground connection to improve off-isolation, or as an additional input to switch matrix A.

# Serially Controlled, Dual 4x2, Clickless Audio/Video Analog Crosspoint Switches

## Detailed Description

The MAX4550/MAX4570 are serial-interface, programmable, dual 4x2 audio/video crosspoint switches. Each device contains two independent 4x2 crosspoint switches, controlled through the on-chip serial interface. The MAX4550 uses a 2-wire I<sup>2</sup>C-compatible serial communications protocol, while the MAX4570 uses a 3-wire SPI/QSPI/MICROWIRE-compatible serial communications protocol.

These ICs include four controllable auxiliary outputs, each capable of sourcing 1mA or sinking 12mA. Also included are four selectable bias-resistor networks (one for each output) for use with AC-coupled input signals. Both devices operate with either  $\pm 5V$  dual supplies or a single +5V supply, and are optimized for use in the audio frequency range to 20kHz and at video frequencies up to 4MHz. They feature 80 $\Omega$  on-resistance, 10 $\Omega$  on-resistance matching between channels, 5 $\Omega$  on-resistance flatness, and as low as 0.004% total harmonic distortion.

The MAX4550/MAX4570 offer better than -110dB of audio off-isolation, -95dB of audio crosstalk, -78dB of video off-isolation, and -54dB of video crosstalk (4MHz). The SA and SB (shunt) inputs further improve off-isolation, allowing for the addition of external shunt capacitors or the connection of outputs to AC grounds. These devices feature a clickless operation mode for noiseless audio switching. Clickless or standard switching mode is selectable for each individual output using the serial interface.

## Applications Information

The MAX4550/MAX4570 are divided into five functional blocks: the control-logic block, two switch-matrix blocks, the bias-resistor block, and the auxiliary-output block (see *Functional Diagram*). The control-logic block accepts commands via the serial interface and uses those commands to control the four remaining blocks.

### Command-Byte and Data-Byte Programming

The devices are programmed through their serial interface with a command byte followed by a data byte. Each bit of the command byte selects one of the functional blocks to be controlled by the subsequent data byte. The data byte sets the state of the selected block(s). For the two switch-matrix blocks, the data byte sets the switch state. For the bias-resistor block, the data byte controls which bias network is active. For the auxiliary-output block, the data byte programs the state of the four auxiliary outputs (see *Functional Diagram*).

A logic “1” in any bit position of the data byte makes that function active, while a logic “0” makes it inactive. Tables 1–4 describe the command byte and the corresponding data byte. For example, if bit C4 of the command byte is set, the subsequent data byte programs the state of the auxiliary outputs. If bits D0 and D2 of the subsequent data byte are set, Q0 and Q2 outputs are set high. If more than one bit of the command byte is set, the data byte programs **all** of the corresponding blocks. This operation is useful, for instance, to simultaneously set both switch matrices to the same configuration. Any block that is not selected in the command byte remains unchanged.

**Table 1. Command-Byte Format**

BIT	REGISTER
C7	Don't care
C6	Don't care
C5	BIAS/MODE
C4	AUX
C3	COM2B
C2	COM1B
C1	COM2A
C0	COM1A

**Table 2. COM Data-Byte Format (C0, C1, C2, C3 = “1”)**

BIT	DESCRIPTION
D7	Don't care
D6	Don't care
D5	Don't care
D4	Controls the switch connected to S <sub>+</sub> ; 1 = close switch, 0 = open switch.
D3	Controls the switch connected to NO4 <sub>+</sub> ; 1 = close switch, 0 = open switch.
D2	Controls the switch connected to NO3 <sub>+</sub> ; 1 = close switch, 0 = open switch.
D1	Controls the switch connected to NO2 <sub>+</sub> ; 1 = close switch, 0 = open switch.
D0	Controls the switch connected to NO1 <sub>+</sub> ; 1 = close switch, 0 = open switch.

# Serially Controlled, Dual 4x2, Clickless Audio/Video Analog Crosspoint Switches

**Table 3. AUX\_ Data-Byte Format (C4 = “1”)**

BIT	DESCRIPTION
D7	Don't care
D6	Don't care
D5	Don't care
D4	Don't care
D3	Controls output Q3; 1 = set output high, 0 = set output low.
D2	Controls output Q2; 1 = set output high, 0 = set output low.
D1	Controls output Q1; 1 = set output high, 0 = set output low.
D0	Controls output Q0; 1 = set output high, 0 = set output low.

**Table 4. Clickless Mode/BIAS\_ Data-Byte Format (C5 = “1”)**

BIT	DESCRIPTION
D7	Controls COM2B clickless mode; 1 = enables clickless mode, 0 = disables clickless mode.
D6	Controls COM1B clickless mode; 1 = enables clickless mode, 0 = disables clickless mode.
D5	Controls COM2A clickless mode; 1 = enables clickless mode, 0 = disables clickless mode.
D4	Controls COM1A clickless mode; 1 = enables clickless mode, 0 = disables clickless mode.
D3	Controls COM2B bias resistors; 1 = connect bias resistors, 0 = disconnect bias resistors.
D2	Controls COM1B bias resistors; 1 = connect bias resistors, 0 = disconnect bias resistors.
D1	Controls COM2A bias resistors; 1 = connect bias resistors, 0 = disconnect bias resistors.
D0	Controls COM1A bias resistors; 1 = connect bias resistors, 0 = disconnect bias resistors.

### 2-Wire Serial Interface

The MAX4550 uses a 2-wire, fast-mode, I<sup>2</sup>C-compatible serial interface. This protocol consists of an address byte followed by the command and data bytes. To address a given chip, the A0 and A1 bits in the address byte must duplicate the values present at the A0 and A1 pins of that chip. The rest of the address bits control MAX4550 operation. The command and data-byte details are described in the *Command-Byte and Data-Byte Programming* section.

The 2-wire serial interface requires only two I/O lines of a standard microprocessor port. Figures 1 and 2 detail the timing diagram for signals on the 2-wire bus, and Table 5 details the format of the signals. The MAX4550 is a receive-only device and must be controlled by a bus master device. A bus master device communicates by transmitting the address byte of the slave device over the bus and then transmitting the desired information. Each transmission consists of a start condition, the MAX4550's programmable slave-address byte, a command-byte, a data-byte, and finally a stop condition. The slave device acknowledges the recognition of its address by pulling the SDA line low for one clock period after the address byte is transmitted. The slave device also issues a similar acknowledgment after the command byte and again after the data byte.

### Start and Stop Conditions

The bus-master signals the beginning of a transmission with a start condition by transitioning SDA from high to low while SCL is high. When the master has finished communicating with the slave, it issues a stop condition by transitioning SDA from low to high while SCL is high. The bus is then free for another transmission.

### Slave Address (Address Byte)

The MAX4550 uses an 8-bit-long slave address. To select a slave address, connect A0 and A1 to V+ or GND. The MAX4550 has four possible slave addresses, thus a maximum of four of these devices may share the same 2-bit address bus. The slave device (MAX4550) monitors the serial bus continuously, waiting for a start condition followed by an address byte. When a slave device recognizes its address (10011A<sub>1</sub>A<sub>0</sub>), it acknowledges that it is ready for further communication by pulling the SDA line low while SCL is high.

### 3-Wire Serial Interface

The MAX4570 3-wire serial interface is SPI/QSPI/MICROWIRE-compatible. An active-low chip-select ( $\overline{CS}$ ) input enables the device to receive data from the serial input (DIN). Data is clocked in on the rising edge of the serial-clock (SCLK) signal. A total of 16 bits are needed in each write cycle. Segmented write cycles are allowed (two 8-bit-wide transfers) if  $\overline{CS}$  remains low. The first bit clocked into the MAX4550 is the command byte's MSB, and the last bit clocked in is the data byte's LSB. While shifting data, the device remains in its original configuration. After all 16 bits are clocked into the input shift register, a rising edge on  $\overline{CS}$  latches the data into the MAX4570 internal registers, initiating the device's change of state.

# Serially Controlled, Dual 4x2, Clickless Audio/Video Analog Crosspoint Switches

**Table 5. 2-Wire Serial-Interface Data Format**

	ADDRESS BYTE									COMMAND BYTE									DATA BYTE									
	A 7	A 6	A 5	A 4	A 3	A 2	A 1	A 0		C 7	C 6	C 5	C 4	C 3	C 2	C 1	C 0		D 7	D 6	D 5	D 4	D 3	D 2	D 1	D 0		
SRT	1	0	0	1	1	A 1	A 0	0	ACK	X	X	B I A S	A U X	C O M M 2 B	C O M M 1 B	C O M M 2 A	C O M M 1 A	ACK	D 7	D 6	D 5	D 4	D 3	D 2	D 1	D 0	ACK	STOP

X = Don't care  
 SRT = Start condition  
 ACK = Acknowledge condition  
 STOP = Stop condition

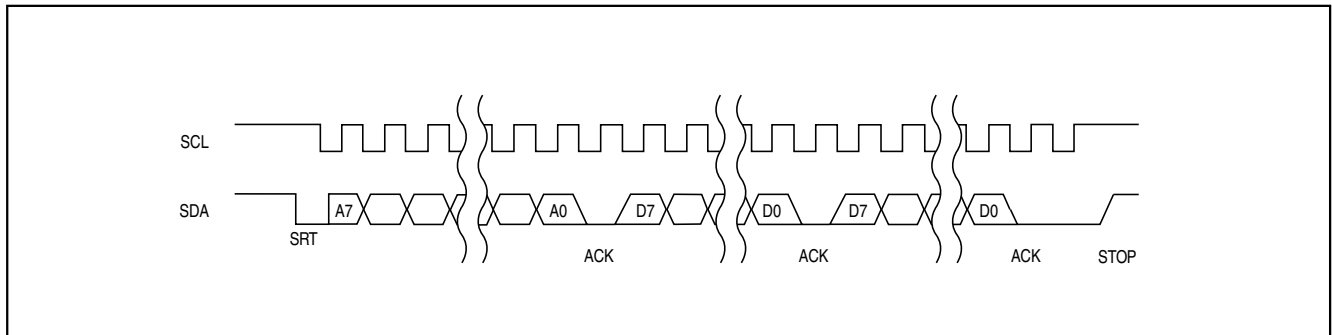

Figure 1. 2-Wire Serial-Interface Timing Diagram

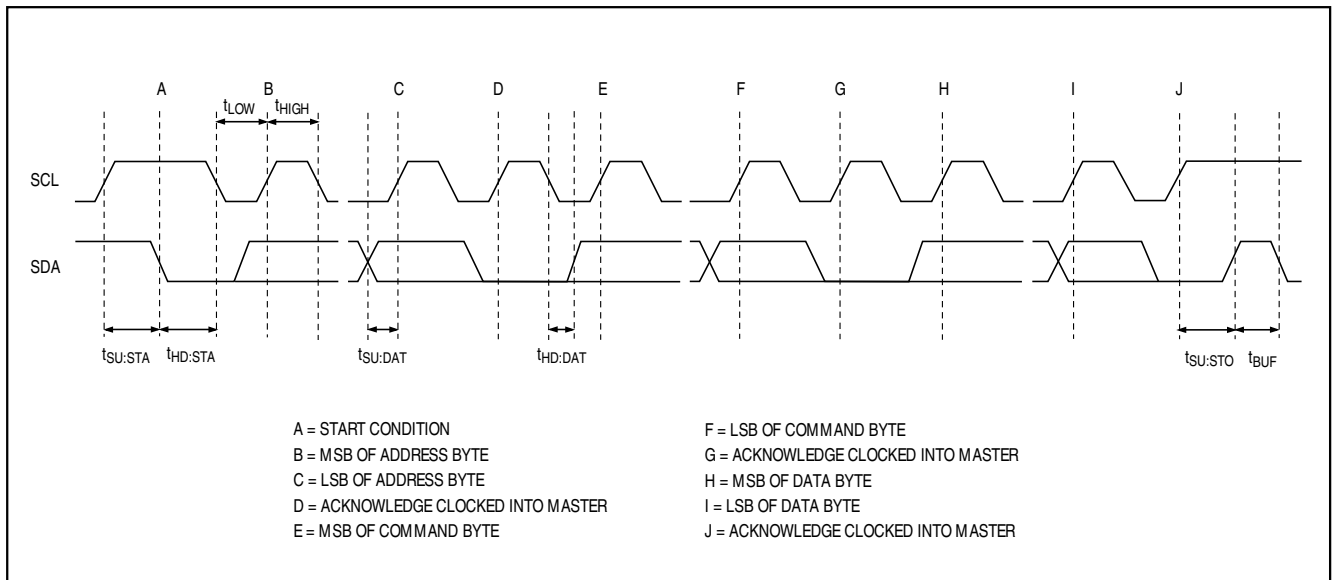

Figure 2. 2-Wire Serial-Interface Timing Details



# Serially Controlled, Dual 4x2, Clickless Audio/Video Analog Crosspoint Switches

Figures 3, 4, and Table 6 show the details of the 3-wire protocol, as it applies to the MAX4570. DOUT is the shift register's output. Data at DOUT is simply the input data delayed by 16 clock cycles, with data appearing synchronous with SCLK's falling edge. Transitions at DIN and SCLK have no effect when  $\overline{CS}$  is high, and DOUT holds the last bit in the shift register.

## Daisy Chaining

To program several MAX4570s, "daisy chain" the devices by connecting DOUT of the first device to DIN of the second, and so on. The  $\overline{CS}$  pins of all devices are connected together, and data is shifted through the MAX4570s in series. 16 bits of data per device are required for proper programming of all devices. When  $\overline{CS}$  is brought high, all devices are updated simultaneously.

MAX4550/MAX4570

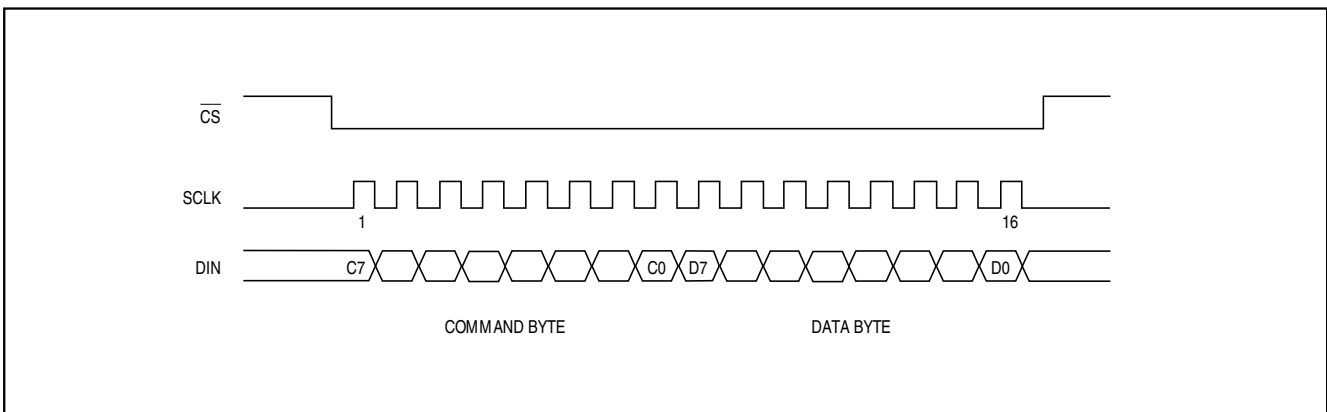

Figure 3. 3-Wire Serial-Interface Communication

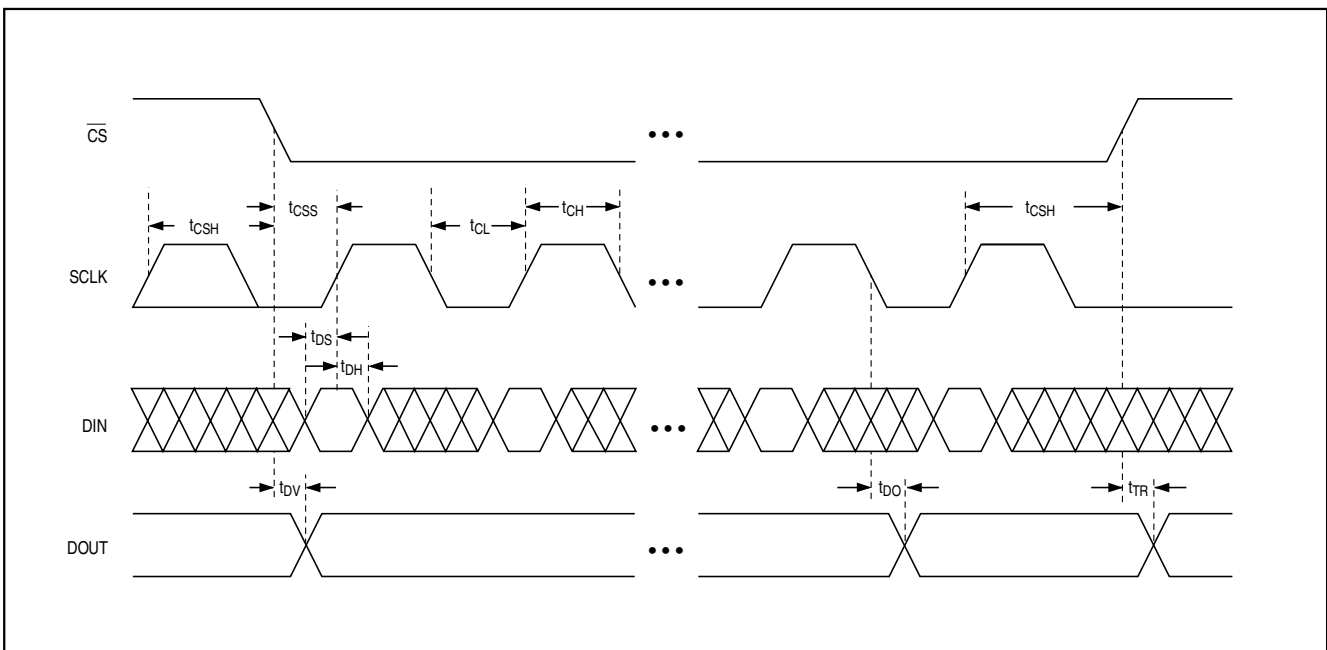

Figure 4. 3-Wire Serial-Interface Timing Details

# Serially Controlled, Dual 4x2, Clickless Audio/Video Analog Crosspoint Switches

**Table 6. 3-Wire Serial-Interface Data Format**

COMMAND BYTE								DATA BYTE							
MSB															LSB
C7	C6	C5	C4	C3	C2	C1	C0	D7	D6	D5	D4	D3	D2	D1	D0
X	X	BIAS	AUX	COM2B	COM1B	COM2A	COM1A	D7	D6	D5	D4	D3	D2	D1	D0

X = Don't care

### Addressable Serial Interface

To program several MAX4570s individually using a single processor, connect DIN of each MAX4570 together and control  $\overline{CS}$  on each MAX4570 separately. To select a particular device, drive the corresponding  $\overline{CS}$  low, clock in the 16-bit command, then drive  $\overline{CS}$  high and execute the command. Typically, only one MAX4570 is addressed at a time.

### Improving Off-Isolation

To improve off-isolation, connect the SA or SB input to ground either directly (DC ground) or through capacitors (AC ground). Closing SA or SB effectively grounds the unused outputs.

### Using the Internal Bias Resistors

Use the internal bias-resistor networks to give the switch outputs a DC bias when the switch terminals are AC coupled. Programming of the switches that connect the bias resistors to the outputs is accomplished via bit C5 of the command byte. Connect the BIASH and BIASL inputs to DC levels (for example, V+ and GND), and activate the switch connecting the appropriate output. This applies a voltage midway between VBIASH and VBIASL to the output (refer to Tables 1, 4, and the *Functional Diagram*).

### Using the Auxiliary Outputs

The four auxiliary outputs provide a way to control external circuitry, such as LEDs or other DC loads, through the serial interface. Program these outputs via bit C4 of the command byte. Each output is capable of sourcing 1mA or sinking 12mA. They are programmed through the command byte and data byte (refer to Tables 1, 3, and the *Functional Diagram*).

### Clickless Switching

Audible switching transients ("clicks") are eliminated in this mode of operation. When an output is configured as "clickless," the gate signal of the switches connected to that output are controlled with slow-moving voltages. As a result, the output slew rates are significantly reduced. Program clickless operation via bit C5 of the command byte (refer to Tables 1, 4, and the *Functional Diagram*). Each operating switch may draw as much as 2mA during transition.

### Power-Up State

The MAX4550/MAX4570 feature a preset power-up state. Upon power-up, COM1A and COM2A are connected to SA, COM1B and COM2B are connected to SB, all outputs are set to clickless mode, all bias-resistor networks are disconnected from the outputs, and all auxiliary outputs are low. All other switches are open.

# Serially Controlled, Dual 4x2, Clickless Audio/Video Analog Crosspoint Switches

Functional Diagram

MAX4550/MAX4570

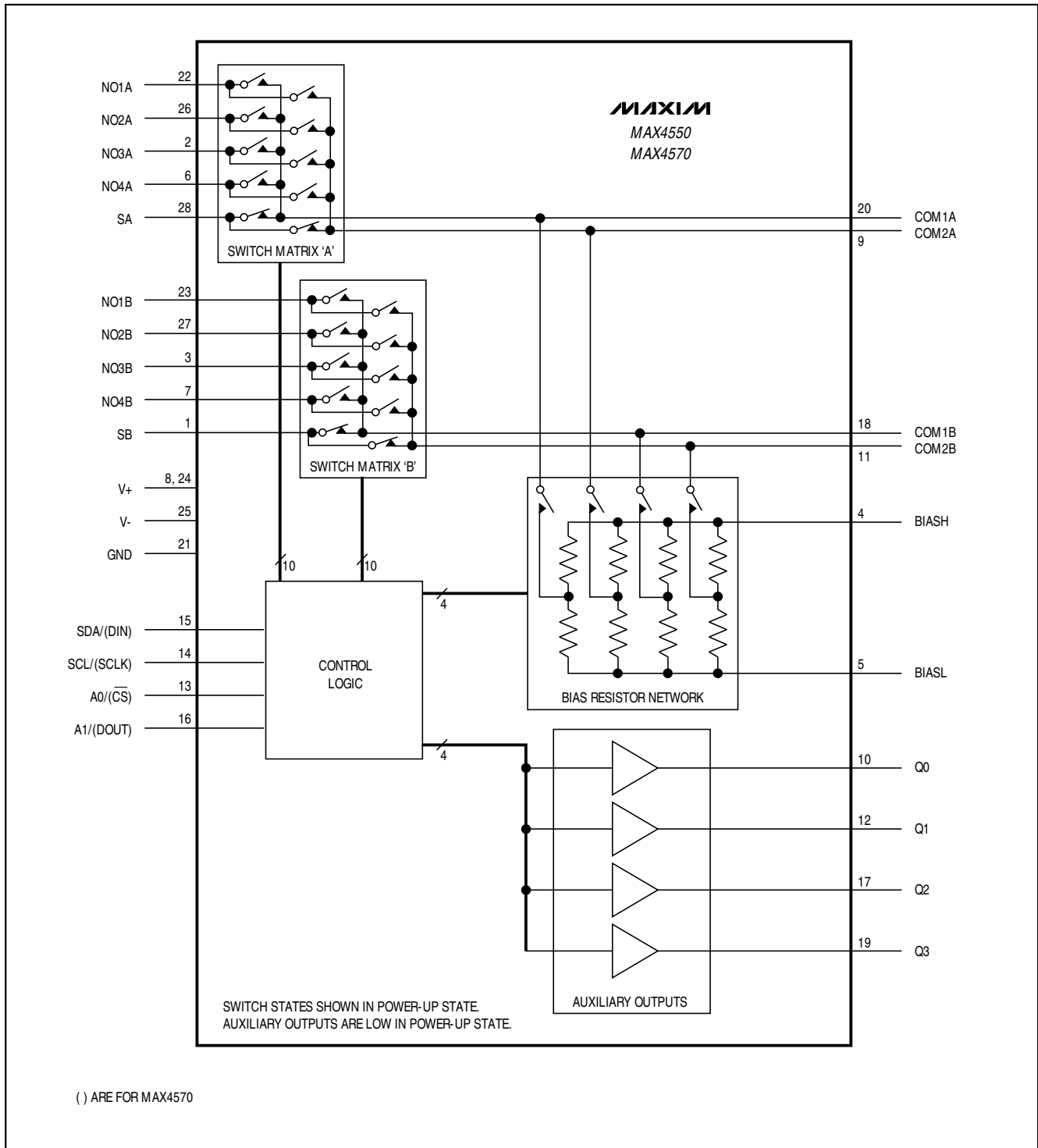

# Serially Controlled, Dual 4x2, Clickless Audio/Video Analog Crosspoint Switches

## Package Information

DIM	INCHES		MILLIMETERS	
	MIN	MAX	MIN	MAX
A	0.068	0.078	1.73	1.99
A1	0.002	0.008	0.05	0.21
B	0.010	0.015	0.25	0.38
C	0.004	0.008	0.09	0.20
D	SEE VARIATIONS			
E	0.205	0.209	5.20	5.38
e	0.0256	BSC	0.65	BSC
H	0.301	0.311	7.65	7.90
L	0.025	0.037	0.63	0.95
$\alpha$	0°	8°	0°	8°

D	INCHES		MILLIMETERS		
	MIN	MAX	MIN	MAX	
D	0.239	0.249	6.07	6.33	14L
D	0.239	0.249	6.07	6.33	16L
D	0.278	0.289	7.07	7.33	20L
D	0.317	0.328	8.07	8.33	24L
D	0.397	0.407	10.07	10.33	28L

NOTES:  
 1. D&E DO NOT INCLUDE MOLD FLASH.  
 2. MOLD FLASH OR PROTRUSIONS NOT TO EXCEED .15mm (.006")  
 3. CONTROLLING DIMENSION: MILLIMETER

**MAXIM**  
 PROPRIETARY INFORMATION  
 TITLE: PACKAGE OUTLINE, SSOP, 5.3X.65mm  
 APPROVAL: \_\_\_\_\_ DOCUMENT CONTROL NO. 21-0056 REV A 1/1

SSOP:EPS

Maxim cannot assume responsibility for use of any circuitry other than circuitry entirely embodied in a Maxim product. No circuit patent licenses are implied. Maxim reserves the right to change the circuitry and specifications without notice at any time.

16 Maxim Integrated Products, 120 San Gabriel Drive, Sunnyvale, CA 94086 408-737-7600