



Chipsmall Limited consists of a professional team with an average of over 10 year of expertise in the distribution of electronic components. Based in Hongkong, we have already established firm and mutual-benefit business relationships with customers from,Europe,America and south Asia,supplying obsolete and hard-to-find components to meet their specific needs.

With the principle of “Quality Parts,Customers Priority,Honest Operation,and Considerate Service”,our business mainly focus on the distribution of electronic components. Line cards we deal with include Microchip,ALPS,ROHM,Xilinx,Pulse,ON,Everlight and Freescale. Main products comprise IC,Modules,Potentiometer,IC Socket,Relay,Connector.Our parts cover such applications as commercial,industrial, and automotives areas.

We are looking forward to setting up business relationship with you and hope to provide you with the best service and solution. Let us make a better world for our industry!



Contact us

Tel: +86-755-8981 8866 Fax: +86-755-8427 6832

Email & Skype: info@chipsmall.com Web: www.chipsmall.com

Address: A1208, Overseas Decoration Building, #122 Zhenhua RD., Futian, Shenzhen, China





MAX5066 Evaluation Kit

Evaluates: MAX5066

General Description

The MAX5066 evaluation kit (EV kit) is a two-phase, dual-output buck converter with a 5V to 16V input voltage range. The MAX5066 EV kit provides dual 0.8V and 1.3V output voltages. It delivers up to 10A output current for each output with 90% efficiency. The MAX5066 EV kit uses average current-mode control and operates at 500kHz switching frequency per phase where each phase is 180° out-of-phase with respect to the other.

This EV kit is a fully assembled and tested circuit board. Both outputs are adjustable between 0.61V and 5.5V by changing feedback resistors R4, R5, R6, and R7. Additional features include thermal-shutdown and "hiccup-mode" short-circuit protection.

Component Suppliers

SUPPLIER	PHONE	WEBSITE
Central Semiconductor	631-435-1110	www.centrasemi.com
Dale-Vishay	402-564-3131	www.vishay.com
Fairchild	888-522-5372	www.fairchildsemi.com
International Rectifier	310-322-3331	www.irf.com
IRC	361-992-7900	www.irctt.com
Kemet	864-963-6300	www.kemet.com
Murata	770-436-1300	www.murata.com
Nihon	847-843-7500	www.niec.co.jp
Sanyo	619-661-6835	www.sanyodevice.com
Sumida	847-545-6700	www.sumida.com
Taiyo Yuden	800-348-2496	www.t-yuden.com
TDK	847-803-6100	www.component.tdk.com
Toshiba	408-526-2459	www.toshiba.com

Note: Indicate that you are using the MAX5066 when contacting these component suppliers.

Features

- ◆ 5V to 16V Input Voltage Range (Design Optimized for 12V Input)
- ◆ Output Voltages
 - 0.8V at 10A (Adjustable from 0.61V to 5.5V)
 - 1.3V at 10A (Adjustable from 0.61V to 5.5V)
- ◆ 500kHz Switching Frequency
- ◆ Both Outputs Can be Paralleled for Higher Current Capability (Using Mode Function)
- ◆ Average Current-Mode Control Provides Accurate Current Limit
- ◆ Current-Sharing Accuracy within ±5% Between Parallel Channels
- ◆ 180° Interleaved Operation Reduces Size of Input Filter Capacitors
- ◆ Overtemperature Shutdown
- ◆ Excellent Line- and Load-Transient Response
- ◆ Hiccup-Mode Overcurrent Protection
- ◆ Can be Synchronized to an External Clock
- ◆ Low-Profile Components
- ◆ Fully Assembled and Tested

Ordering Information

PART	TEMP RANGE	IC PACKAGE
MAX5066EVKIT	0°C to +70°C	28 TSSOP

Component List

DESIGNATION	QTY	DESCRIPTION
C1, C2	2	10µF ±20%, 25V X5R (1812) ceramic capacitors Taiyo Yuden TMK432BJ106KM TDK C4532X5R1E106M
C3	1	4.7µF ±20%, 6.3V X5R (0805) ceramic capacitor Murata GRM21BR60J475M Taiyo Yuden JMK212BJ475MG TDK C2012X5R0J475M
C4–C7, C24	5	0.1µF ±10%, 25V X7R (0603) ceramic capacitors Kemet C0603C104K3RAC Murata GRM188R71E104K TDK C1608X7R1E104K

DESIGNATION	QTY	DESCRIPTION
C8, C13, C14	3	1µF ±10%, 16V X5R (0805) ceramic capacitors Kemet C0805C105K4PAC Taiyo Yuden EMK212BJ105KG TDK C2012X5R1C105K
C9–C12, C20–C23	8	100µF ±20%, 6.3V X5R (1210) ceramic capacitors TDK C3225X5R0J107M
C15	1	0.22µF, 10V X7R (0603) ceramic capacitor Taiyo Yuden LMK107BJ224MA or TDK C1608X7R1C224M



MAX5066 Evaluation Kit

Component List (continued)

DESIGNATION	QTY	DESCRIPTION	
C16	1	68pF $\pm 5\%$, 50V C0G (0603) ceramic capacitor Kemet C0603C680J5GAC Murata GRM1885C1H680J Taiyo Yuden UMK107CG680JZ TDK C1608C0G1H680J	
C17	1	6800pF $\pm 10\%$, 50V X7R (0603) ceramic capacitor Kemet C0603C682K5RAC Taiyo Yuden UMK107B682KZ TDK C1608X7R1H682K	
C18	1	150pF $\pm 5\%$, 50V C0G (0603) ceramic capacitor Kemet C0603C151J5GAC Murata GRM1885C1H151J Taiyo Yuden UMK107CG151JZ TDK C1608C0G1H151J	
C19	1	0.033 μ F $\pm 10\%$, 50V X7R (0603) ceramic capacitor Murata GRM188R71H333K TDK C1608X7R1H333K	
D1, D2	2	100mA, 30V Schottky diodes (SOT23) Central Semiconductor CMPSH-3	Top mark: D95
D3, D4	2	3A, 30V Schottky diodes Nihon EC31QS03L Central Semiconductor CMSH3-40M	
JU1, JU2, JU3	3	3-pin headers, 0.1in centers Digi-Key S1012-03-ND or equivalent	

Recommended Equipment

- 5V to 16V power supply
- Two loads capable of sinking 10A each
- Digital multimeters (DMMs)
- 100MHz dual-trace oscilloscope

Quick Start

- 1) Ensure that the circuit is connected correctly to the supplies and loads prior to applying any power.
- 2) Verify that the shunts are across:
 - JU1 pins 1 and 2 (OUT1 enabled)
 - JU2 pins 1 and 2 (OUT2 enabled)
 - JU3 pins 2 and 3 (two-output, out-of-phase operation)

DESIGNATION	QTY	DESCRIPTION
L1, L2	2	0.8 μ H, 2m Ω , 16A power inductors Sumida CDEP105(L)-0R8
N1, N2	2	MOSFETs, n-channel, 30V, 13.6A, 9.1m Ω , SO-8 International Rectifier IRF7821
N3, N4	2	MOSFETs, n-channel, 30V, 20A, 4m Ω , SO-8 International Rectifier IRF7832
R1, R2	2	0.002 Ω $\pm 1\%$, 1W resistors (2512) Panasonic ERJM1WSF2M0U Dale WSL-2512-R002F or IRC LR2512-01-R002-F
R3	1	1 Ω $\pm 5\%$ resistor (1206)
R4	1	1.74k Ω $\pm 1\%$ (0603) resistor
R5	1	4.64k Ω $\pm 1\%$ (0603) resistor
R6	1	5.11k Ω $\pm 1\%$ (0603) resistor
R7	1	4.75k Ω $\pm 1\%$ (0603) resistor
R8	1	20k Ω $\pm 1\%$ (0603) resistor
R9	1	60.4k Ω $\pm 1\%$ (0603) resistor
R10, R11	2	22 Ω $\pm 5\%$ (0603) resistors
R12	1	24.9k Ω $\pm 1\%$ (0603) resistor
R13, R14	2	0 Ω (0603) resistors
R15	1	2.55k Ω $\pm 1\%$ (0603) resistor
R16	1	1k Ω $\pm 5\%$ (0603) resistor
U1	1	MAX5066EUI, 28-pin TSSOP
—	3	Shunts, 0.1in centers Sullins STC02SYAN or equivalent
—	1	MAX5066 EV kit PC board

- 3) Turn on the power supply and adjust the input voltage to 12V.
- 4) Verify that the output voltages are $V_{OUT1} = 0.8V$ and $V_{OUT2} = 1.3V$.

Detailed Description

Jumper Settings

Table 1. Jumper JU1 Functions (Output 1 Enable Control)

JU1	EN1 PIN	OUT1
1 and 2 (default)	Connected to VREG	OUT1 is enabled, $V_{OUT1} = 0.8V$
2 and 3	Connected to GND	OUT1 is disabled, $V_{OUT1} = 0V$

MAX5066 Evaluation Kit

Evaluates: MAX5066

Table 2. Jumper JU2 Functions (Output 2 Enable Control)

JU2	EN2 PIN	OUT2
1 and 2 (default)	Connected to VREG	OUT2 is enabled, $V_{OUT2} = 1.3V$
2 and 3	Connected to GND	OUT2 is disabled, $V_{OUT2} = 0V$

Dual-Output/Dual-Phase Select (Mode Function)

The MAX5066 can operate as a dual-output, independently regulated buck converter, or as a dual-phase, single-output buck converter. The MODE input selects between the two operating modes. When MODE is grounded (logic-low), the MAX5066 operates as a two-output DC-DC converter. When MODE is connected to REG (logic-high), the MAX5066 works as a dual-phase, single-output buck regulator with each phase 180° out-of-phase with respect to each other.

Operating the MAX5066 as a single-output, dual-phase DC-DC controller requires changes to the EV kit. Each DC-DC controller should have identical external components and the output of both DC-DC controllers should be connected to form a single output. Refer to the MAX5066 data sheet for selecting the appropriate components.

Table 3. Jumper JU3 Functions (Mode Function)

JU3	Mode PIN	OPERATING MODE
1 and 2 (default)	Connected to VREG	MAX5066 operates as a single-output, dual-phase buck regulator
2 and 3	Connected to GND	MAX5066 operates as a two-output, out-of-phase buck regulator

Evaluating Other Output Voltages

The MAX5066 provides a programmed dual 0.8V output (OUT1) and 1.3V output (OUT2). Both outputs can also be adjusted from 0.61V to 5.5V by using resistive voltage-dividers formed by R4, R5 and R6, R7.

The adjusted output voltages are:

$$V_{OUT1} = 0.61V(1 + R4 / R5)$$

$$V_{OUT2} = 0.61V(1 + R6 / R7)$$

Note: Refer to the MAX5066 data sheet for selection of output capacitors, inductor, and network compensation values for different output voltages.

Evaluates: MAX5066

MAX5066 Evaluation Kit

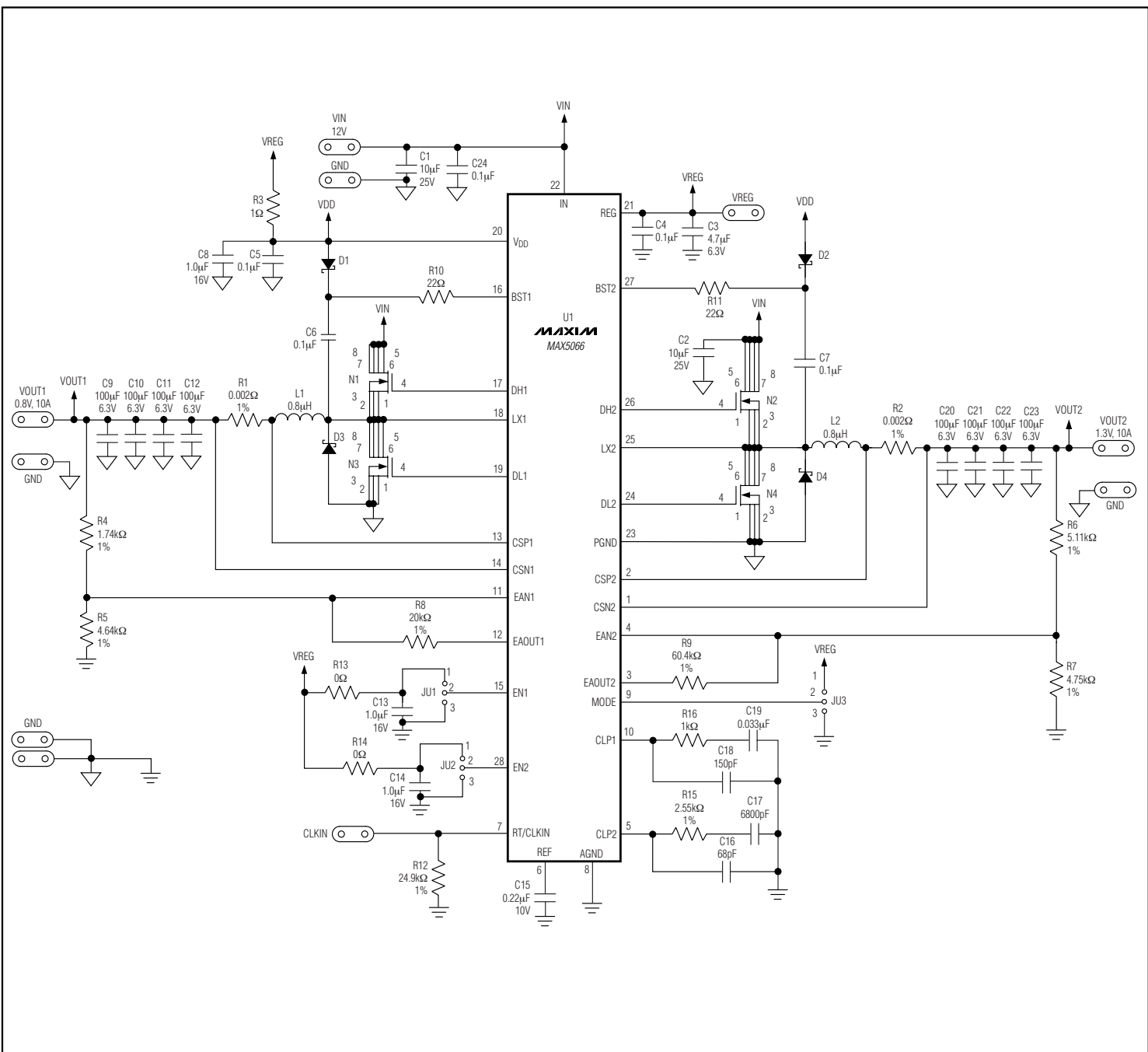

Figure 1. MAX5066 EV Kit Schematic

MAX5066 Evaluation Kit

Evaluates: MAX5066

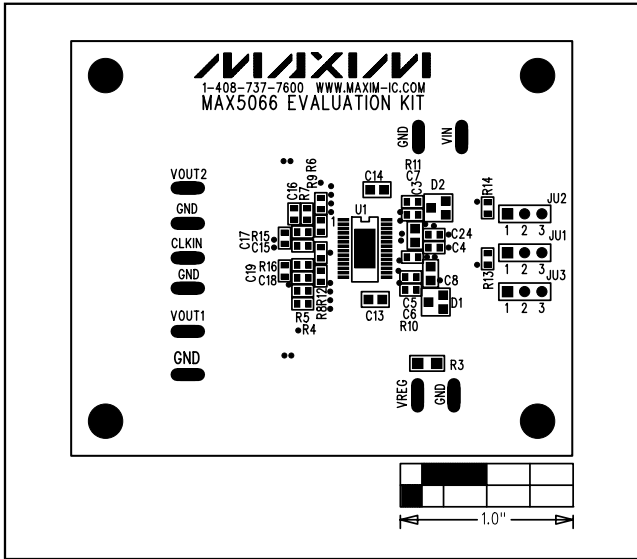

Figure 2. MAX5066 EV Kit Component Placement Guide—Component Side

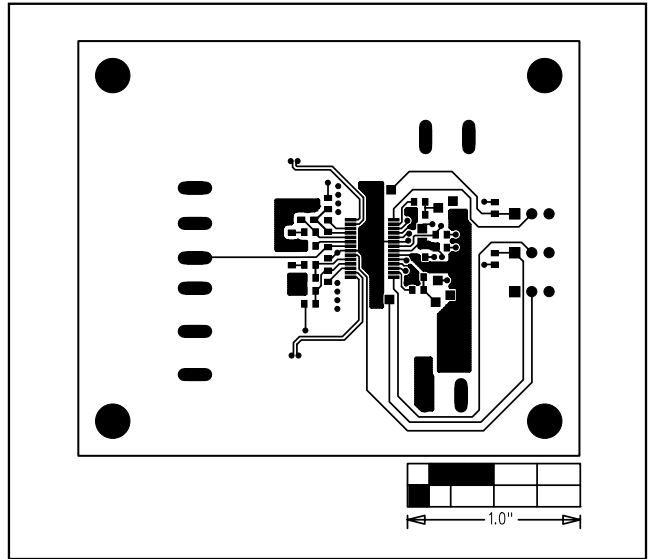

Figure 3. MAX5066 EV Kit PC Board Layout—Component Side

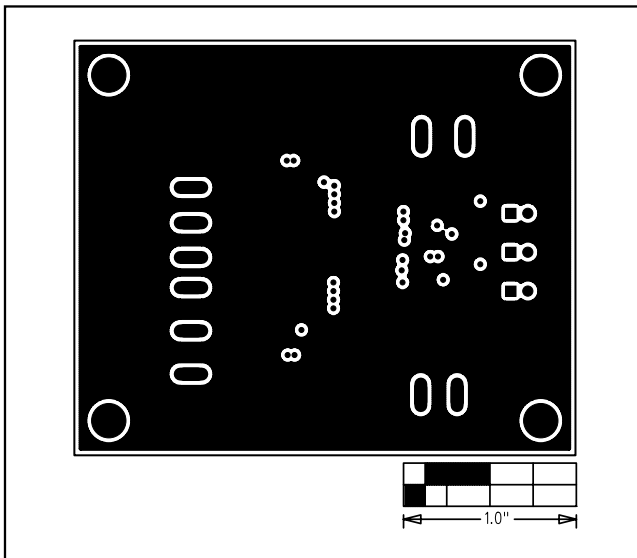

Figure 4. MAX5066 EV Kit PC Board Layout—Internal Layer 2—AGND Plane

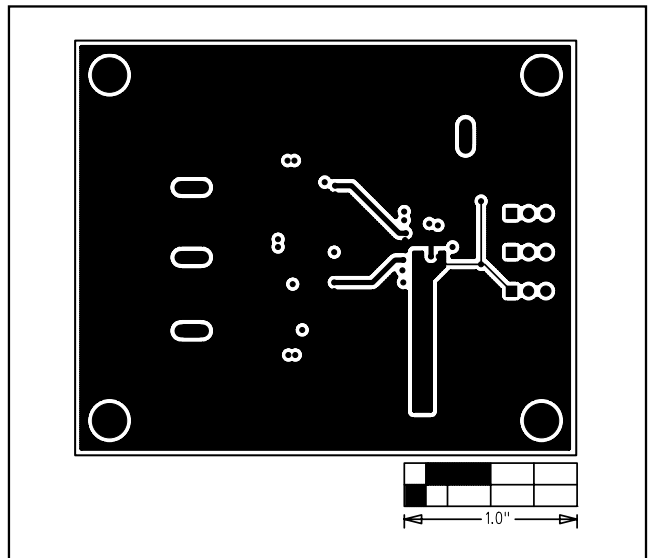

Figure 5. MAX5066 EV Kit PC Board Layout—Internal Layer 3—PGND Plane

MAX5066 Evaluation Kit

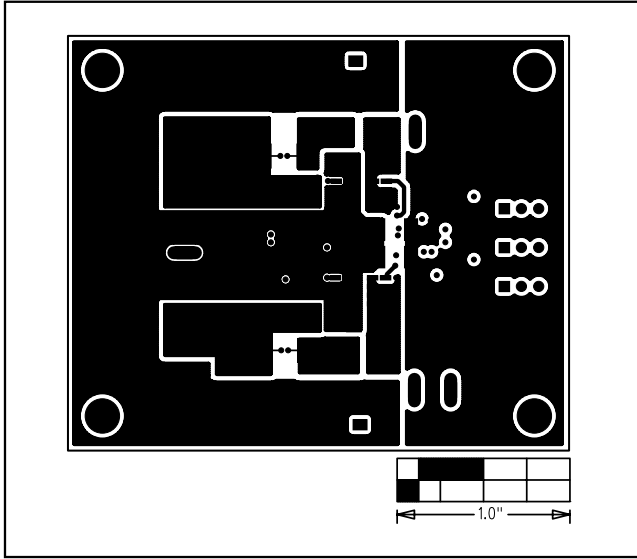

Figure 6. MAX5066 EV Kit PC Board Layout—Solder Side

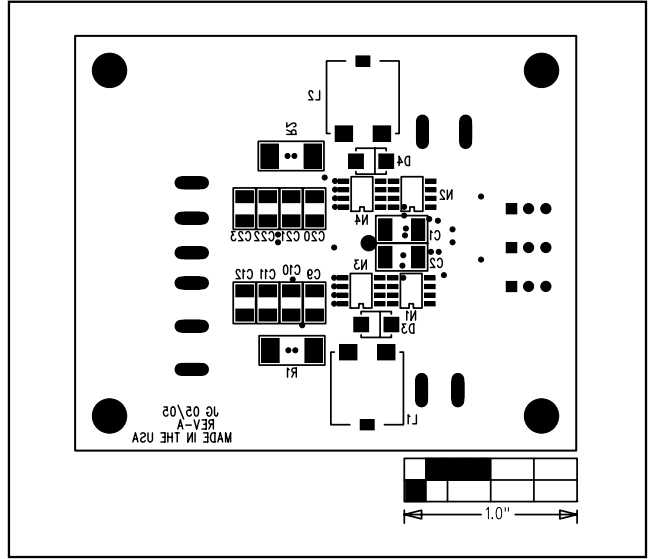

Figure 7. MAX5066 EV Kit Component Placement Guide—Solder Side

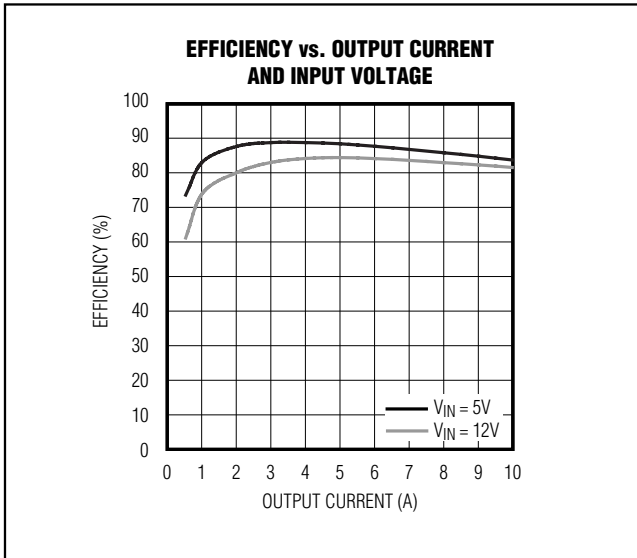

Figure 8. Efficiency vs. Output Current, Switching Frequency = 400kHz

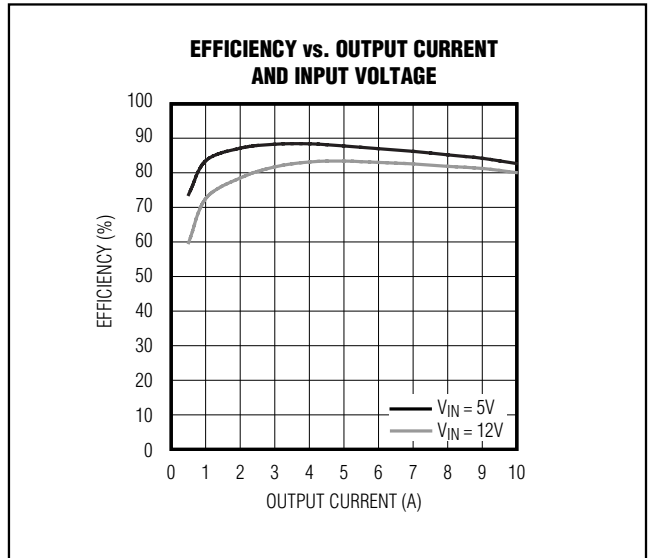

Figure 9. Efficiency vs. Output Current, Switching Frequency = 500kHz

Revision History

Pages changed at Rev 1: 1, 2, 4, 6

Maxim cannot assume responsibility for use of any circuitry other than circuitry entirely embodied in a Maxim product. No circuit patent licenses are implied. Maxim reserves the right to change the circuitry and specifications without notice at any time.

6 Maxim Integrated Products, 120 San Gabriel Drive, Sunnyvale, CA 94086 408-737-7600