



Chipsmall Limited consists of a professional team with an average of over 10 year of expertise in the distribution of electronic components. Based in Hongkong, we have already established firm and mutual-benefit business relationships with customers from,Europe,America and south Asia,supplying obsolete and hard-to-find components to meet their specific needs.

With the principle of “Quality Parts,Customers Priority,Honest Operation,and Considerate Service”,our business mainly focus on the distribution of electronic components. Line cards we deal with include Microchip,ALPS,ROHM,Xilinx,Pulse,ON,Everlight and Freescale. Main products comprise IC,Modules,Potentiometer,IC Socket,Relay,Connector.Our parts cover such applications as commercial,industrial, and automotives areas.

We are looking forward to setting up business relationship with you and hope to provide you with the best service and solution. Let us make a better world for our industry!



Contact us

Tel: +86-755-8981 8866 Fax: +86-755-8427 6832

Email & Skype: info@chipsmall.com Web: www.chipsmall.com

Address: A1208, Overseas Decoration Building, #122 Zhenhua RD., Futian, Shenzhen, China



MAX5216PMB1 Peripheral Module

General Description

The MAX5216PMB1 peripheral module provides the necessary hardware to interface the MAX5216 16-bit DAC to any system that utilizes Pmod™-compatible expansion ports configurable for SPI communication. The IC is a single-channel, low-power, buffered voltage-output DAC. The reference voltage for the DAC is provided by a 2.5V output version of the MAX6029 voltage reference (0.15% initial accuracy, 30ppm/°C). Digital noise is minimized by having SPI input buffers powered down after completion of each serial input frame.

Refer to the MAX5216 IC data sheet for detailed information regarding operation of the IC.

Ordering Information appears at end of data sheet.

Features

- ◆ High-Accuracy 16-Bit DAC with On-Board Precision Voltage Reference
- ◆ Low Gain and Offset Errors
- ◆ Buffered Voltage Output Directly Drives 10kΩ Loads
- ◆ Optional External Voltage Reference (Jumper Selectable)
- ◆ 6-Pin Pmod-Compatible Connector (SPI)
- ◆ Example Software Written in C for Portability
- ◆ RoHS Compliant
- ◆ Proven PCB Layout
- ◆ Fully Assembled and Tested

MAX5216PMB1 Peripheral Module

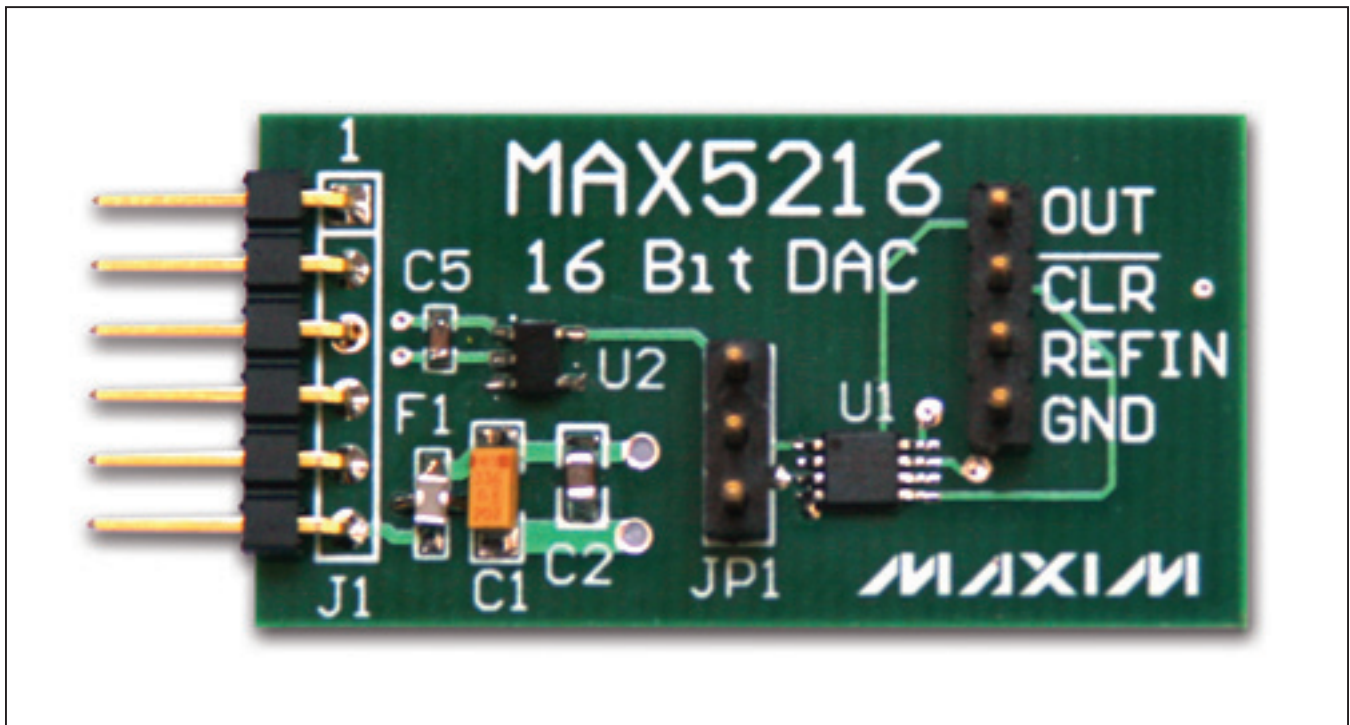

Pmod is a trademark of Digilent Inc.

MAX5216PMB1 Peripheral Module

Component List

DESIGNATION	QTY	DESCRIPTION
C1	1	10 μ F \pm 10%, 10V X5R ceramic capacitor (0603) TDK C2012X5R1A106K/1.25
C2	1	1 μ F \pm 10%, 10V X7R ceramic capacitor (0603) TDK C1608X7R1A105K
C3, C4, C5	3	0.1 μ F \pm 10%, 16V X7R ceramic capacitors (0603) Murata GRM188R71C104KA01D
F1	1	4.7 μ F EMI filter (3-terminal capacitor) Murata NFM21PC475B1A3D
J1	1	6-pin right-angle male header

DESIGNATION	QTY	DESCRIPTION
J2	1	4-pin straight male header
JP1	1	3-pin straight male header
R1, R2, R3	3	150 Ω \pm 5% resistors (0603)
R4	1	4.7k Ω \pm 5% resistor (0603)
U1	1	16-bit buffered single DAC (8 μ MAX [®]) Maxim MAX5216GUA+
U2	1	Ultra-precision series voltage reference (5 SOT23) Maxim MAX6029EUK25+
—	1	Shorting jumper
—	1	PCB: EPCB5216PM1

Component Suppliers

SUPPLIER	PHONE	WEBSITE
Murata Electronics North America, Inc.	770-436-1300	www.murata-northamerica.com
TDK Corp.	847-803-6100	www.component.tdk.com

Note: Indicate that you are using the MAX5216PMB1 when contacting these component suppliers.

Detailed Description

SPI Interface

The MAX5216PMB1 peripheral module can plug directly into a Pmod-compatible port (configured for SPI) through connector J1. For information on the SPI protocol, refer to the MAX5214/MAX5216 IC data sheet.

J1 provides connection of the module to the Pmod host. See Table 1.

Connector J2 provides connection to the IC pins.

Jumper JP1 allows the user to select between reference voltages for the DAC IC (see Table 3).

Reference Voltage

The MAX5216PMB1 peripheral module contains a MAX6029 precision voltage reference for the REF input of the IC. The MAX6029 outputs a 2.5V reference.

Software and FPGA code

Example software and drivers are available that execute directly without modification on several FPGA development boards that support an integrated or synthesized microprocessor. These boards include the Digilent

Table 1. Connector J1 (2-Wire Communication)

PIN	SIGNAL	DESCRIPTION
1	\overline{SS}	Chip enable. Assert low to enable the SPI interface.
2	MOSI	MAX5216 serial-data input
3	N.C.	Not connected
4	SCK	MAX5216 serial-clock input
5	GND	Ground
6	VCC	Power supply

Table 2. Connector J2

PIN	SIGNAL	DESCRIPTION
1	DACOUT	Buffered DAC output
2	\overline{CLR}	Active-low asynchronous digital-clear input. Drive low to clear contents of the DAC registers and set the DAC output to zero.
3	VREFIN	DAC reference voltage input
4	GND	Ground

μ MAX is a registered trademark of Maxim Integrated Products, Inc.

MAX5216PMB1 Peripheral Module

Nexys 3, Avnet LX9, and Avnet ZEDBoard, although other platforms can be added over time. Maxim provides complete Xilinx ISE projects containing HDL, Platform Studio, and SDK projects. In addition, a synthesized bit stream, ready for FPGA download, is provided for the demonstration application.

The software project (for the SDK) contains several source files intended to accelerate customer evaluation and design. These include a base application (maximModules.c) that demonstrates module functionality and uses an API interface (maximDeviceSpecificUtilities.c) to set and access Maxim device functions within a specific module.

Table 3. Jumper JP1 (Reference Voltage Selection)

PINS	SELECTION
2-1	REF provided by on-board MAX6029EUK25 voltage reference
2-3	REF provided by user through pin 3 of connector J2

The source code is written in standard ANSI C format, and all API documentation including theory/operation, register description, and function prototypes are documented in the API interface file (maximDeviceSpecificUtilities.h & .c).

The complete software kit is available for download www.maxim-ic.com. Quick start instructions are also available as a separate document.

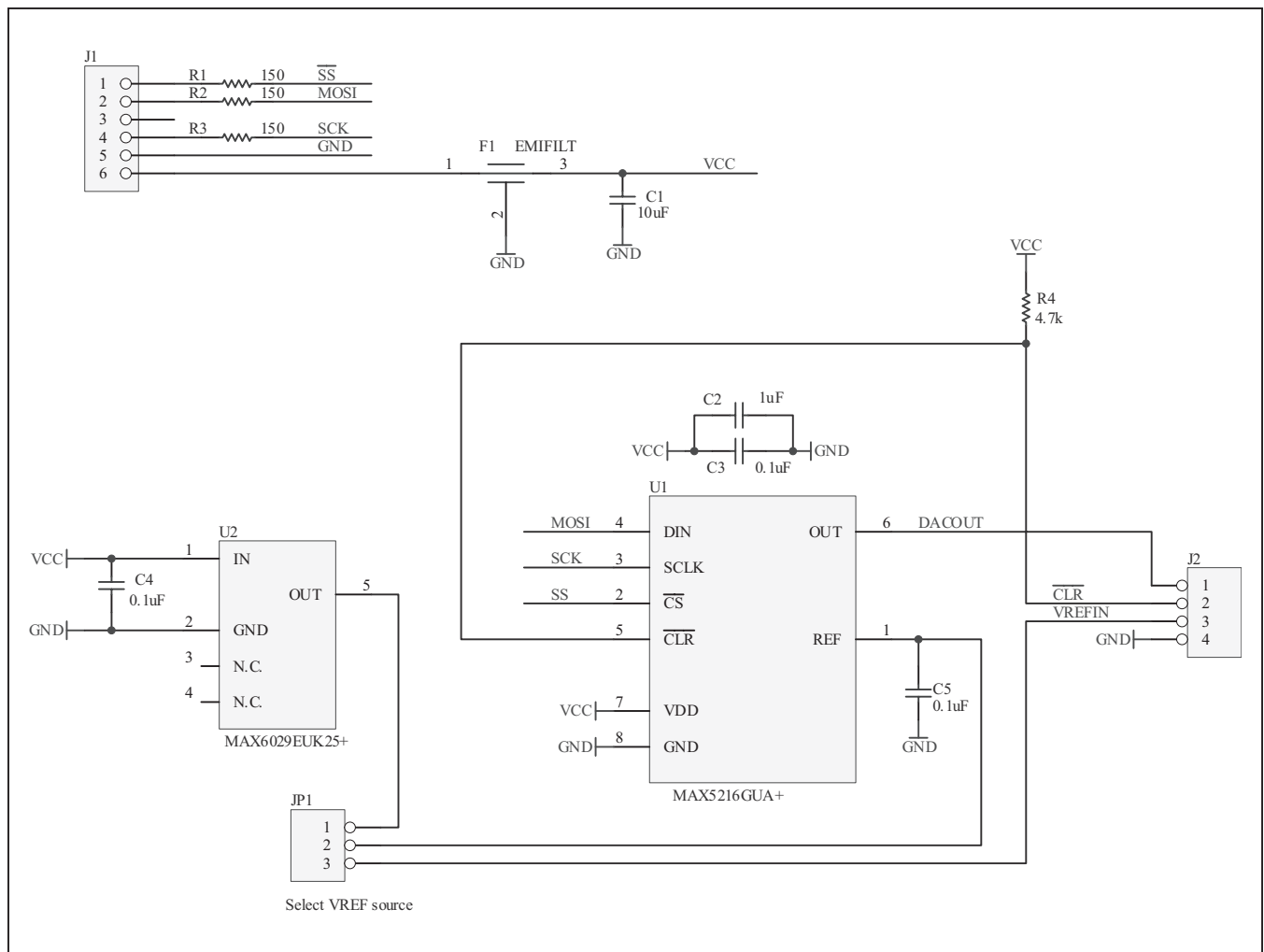

Figure 1. MAX5216PMB1 Peripheral Module Schematic

MAX5216PMB1 Peripheral Module

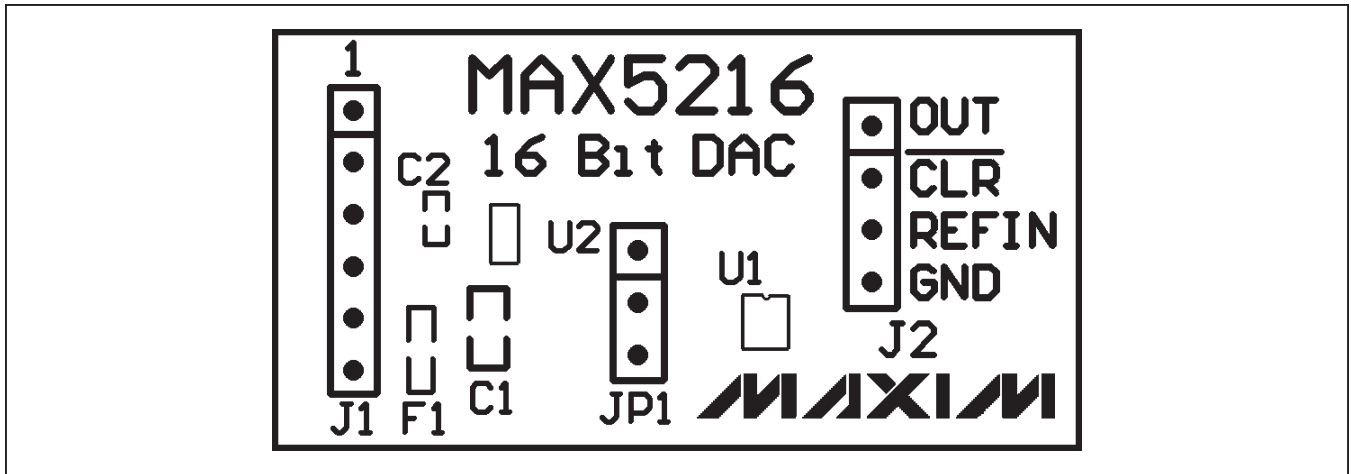

Figure 2. MAX5216PMB1 Peripheral Module Component Placement Guide—Component Side

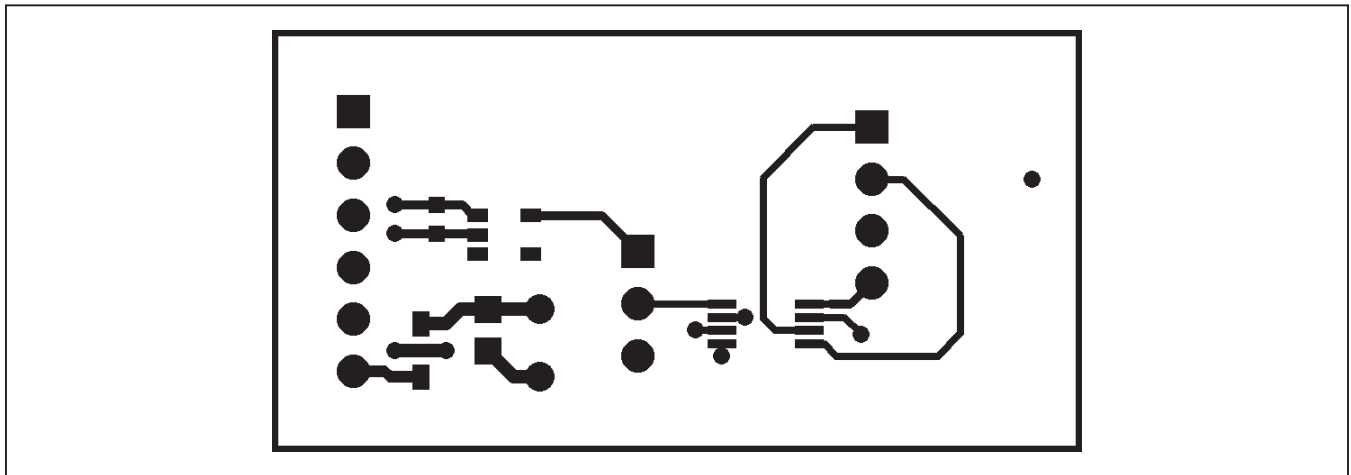

Figure 3. MAX5216PMB1 Peripheral Module PCB Layout—Component Side

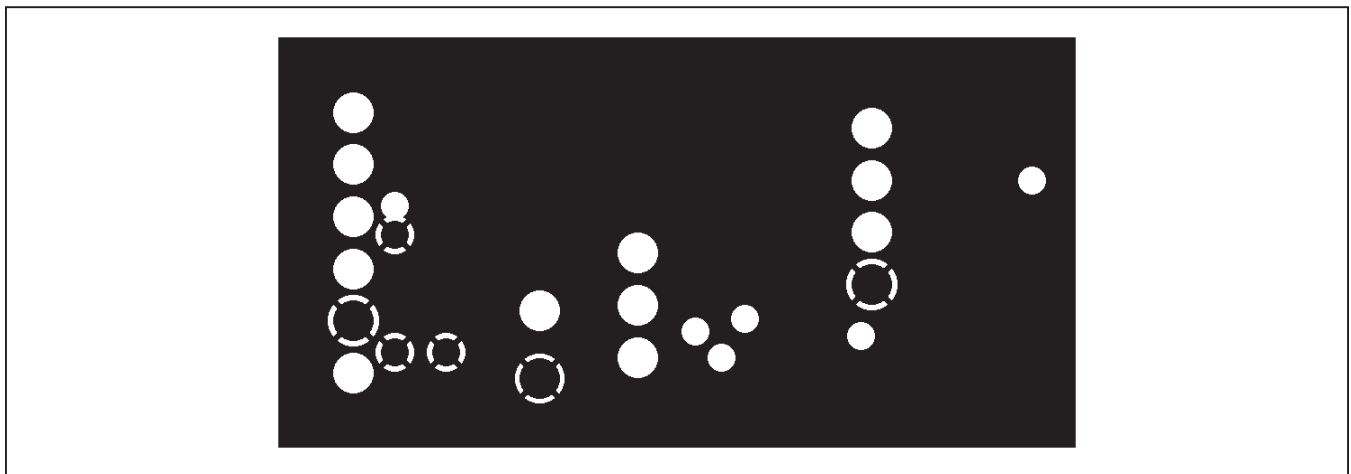

Figure 4. MAX5216PMB1 Peripheral Module PCB Layout—Inner Layer 1 (Ground)

MAX5216PMB1 Peripheral Module

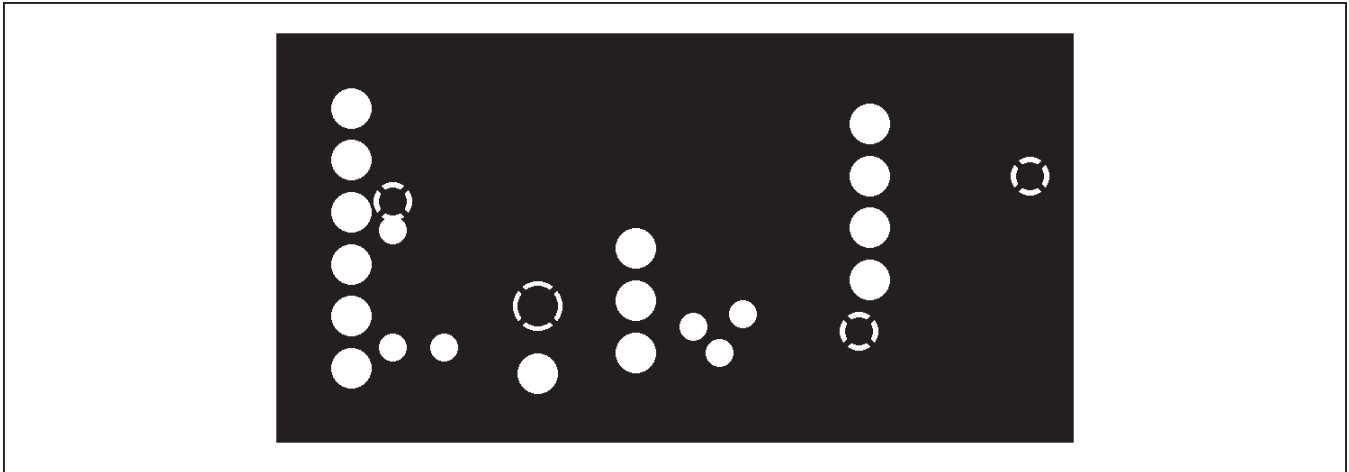

Figure 5. MAX5216PMB1 Peripheral Module PCB Layout—Inner Layer 2 (Power)

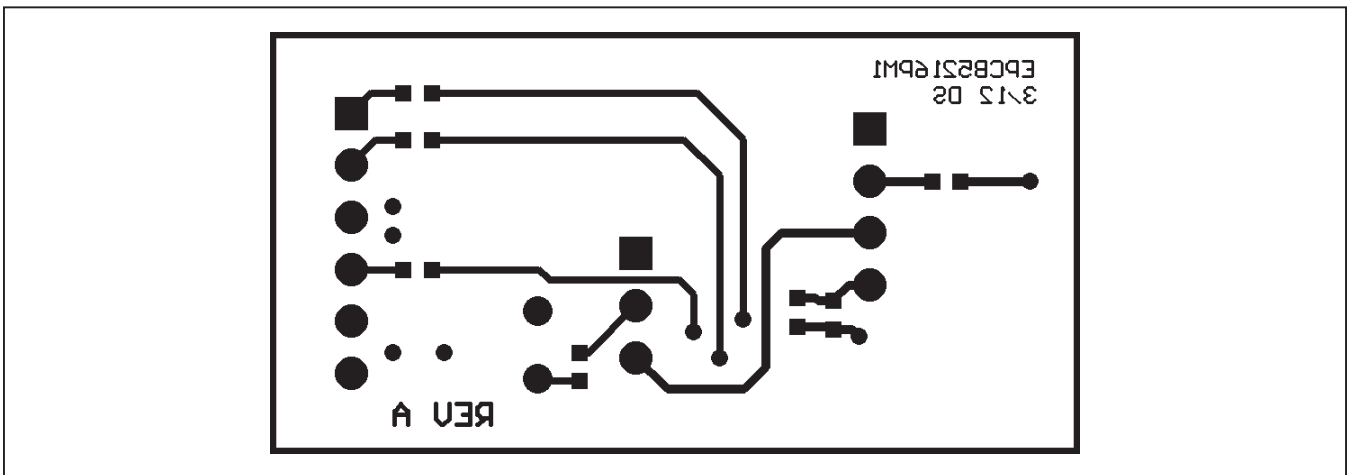

Figure 6. MAX5216PMB1 Peripheral Module PCB Layout—Solder Side

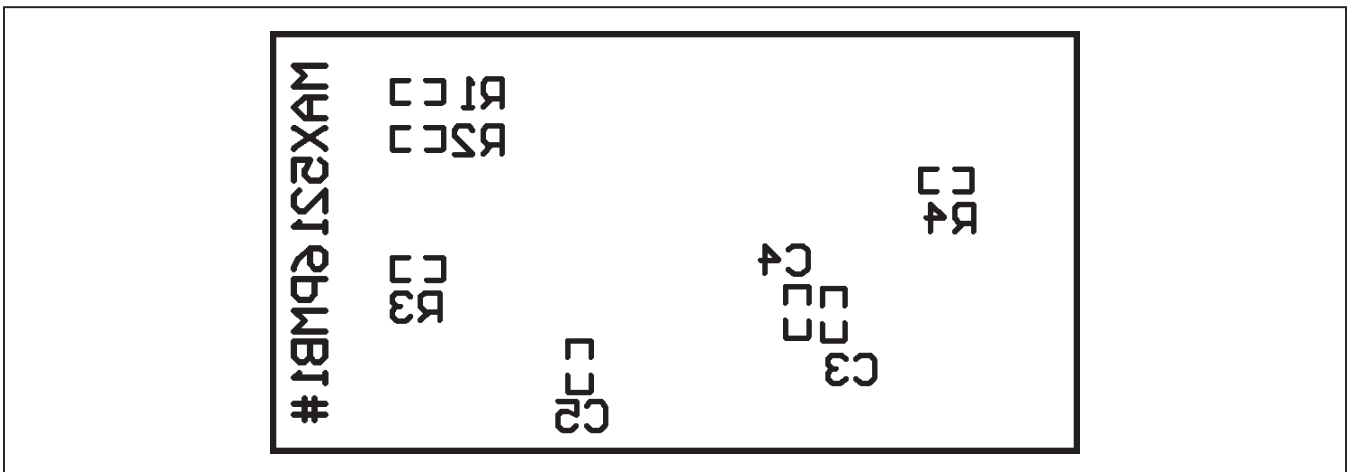

Figure 7. MAX5216PMB1 Peripheral Module Component Placement Guide—Solder Side

MAX5216PMB1 Peripheral Module

Ordering Information

PART	TYPE
MAX5216PMB1#	Peripheral Module

#Denotes RoHS compliant.

MAX5216PMB1 Peripheral Module

Revision History

REVISION NUMBER	REVISION DATE	DESCRIPTION	PAGES CHANGED
0	5/12	Initial release	—

Maxim cannot assume responsibility for use of any circuitry other than circuitry entirely embodied in a Maxim product. No circuit patent licenses are implied. Maxim reserves the right to change the circuitry and specifications without notice at any time.

Maxim Integrated Products, 120 San Gabriel Drive, Sunnyvale, CA 94086 408-737-7600 _____ 7