



Chipsmall Limited consists of a professional team with an average of over 10 year of expertise in the distribution of electronic components. Based in Hongkong, we have already established firm and mutual-benefit business relationships with customers from,Europe,America and south Asia,supplying obsolete and hard-to-find components to meet their specific needs.

With the principle of “Quality Parts,Customers Priority,Honest Operation,and Considerate Service”,our business mainly focus on the distribution of electronic components. Line cards we deal with include Microchip,ALPS,ROHM,Xilinx,Pulse,ON,Everlight and Freescale. Main products comprise IC,Modules,Potentiometer,IC Socket,Relay,Connector.Our parts cover such applications as commercial,industrial, and automotives areas.

We are looking forward to setting up business relationship with you and hope to provide you with the best service and solution. Let us make a better world for our industry!



## Contact us

Tel: +86-755-8981 8866 Fax: +86-755-8427 6832

Email & Skype: info@chipsmall.com Web: www.chipsmall.com

Address: A1208, Overseas Decoration Building, #122 Zhenhua RD., Futian, Shenzhen, China





# +5V, Serial-Input, Voltage-Output, 14-Bit DACs

MAX544/MAX545

## General Description

The MAX544/MAX545 are serial-input, voltage-output, 14-bit digital-to-analog converters (DACs) that operate from a single +5V supply. They provide 14-bit performance ( $\pm 0.5\text{LSB INL}$  and  $\pm 0.9\text{LSB DNL}$ ) over temperature without any adjustments. The DAC output is unbuffered, resulting in a low supply current of 0.3mA and a low offset error of 0.6mV.

The DAC output range is 0V to  $V_{REF}$ . For bipolar operation, matched scaling resistors are provided in the MAX545 for use with an external precision op amp (such as the MAX400), generating a  $\pm V_{REF}$  output swing. The MAX545 also includes Kelvin-sense connections for the reference and analog ground pins to reduce layout sensitivity.

A 16-bit serial word is used to load data into the DAC latch. The 10MHz, 3-wire serial interface is compatible with SPI™/QSPI™/MICROWIRE™, and it also interfaces directly with optocouplers for applications requiring isolation. A power-on reset circuit clears the DAC output to 0V (unipolar mode) when power is initially applied.

The MAX544 is available in 8-pin plastic DIP and SO packages. The MAX545 is available in 14-pin plastic DIP and SO packages.

## Applications

- Digital Offset and Gain Adjustment
- Instrumentation
- Industrial Process Control
- Automated Test Equipment
- Data-Acquisition Systems

## Pin Configurations

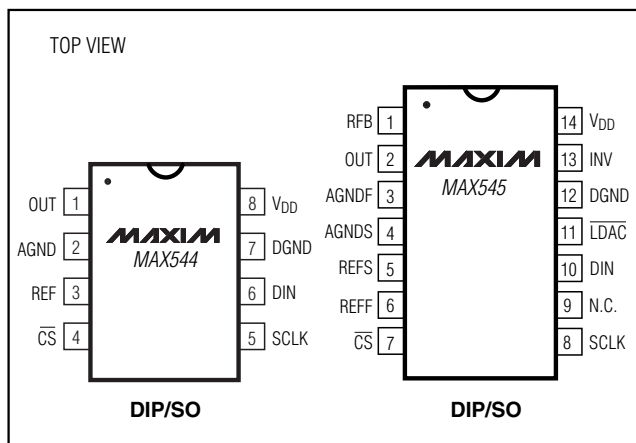

SPI and QSPI are trademarks of Motorola, Inc.  
MICROWIRE is a trademark of National Semiconductor Corp.

## Features

- ◆ Full 14-Bit Performance Without Adjustments
- ◆ +5V Single-Supply Operation
- ◆ Low Power: 1.5mW
- ◆ 1µs Settling Time
- ◆ Unbuffered Voltage Output Directly Drives 60kΩ Loads
- ◆ SPI/QSPI/MICROWIRE-Compatible Serial Interface
- ◆ Power-On Reset Circuit Clears DAC Output to 0V (unipolar mode)
- ◆ Schmitt-Trigger Inputs for Direct Optocoupler Interface
- ◆ Pin-Compatible 16-Bit Upgrades (MAX541/MAX542)

## Ordering Information

| PART       | TEMP. RANGE  | PIN-PACKAGE   | INL (LSB) |
|------------|--------------|---------------|-----------|
| MAX544ACPA | 0°C to +70°C | 8 Plastic DIP | $\pm 1/2$ |
| MAX544BCPA | 0°C to +70°C | 8 Plastic DIP | $\pm 1$   |
| MAX544ACSA | 0°C to +70°C | 8 SO          | $\pm 1/2$ |
| MAX544BCSA | 0°C to +70°C | 8 SO          | $\pm 1$   |

Ordering Information continued at end of data sheet.

## Functional Diagrams

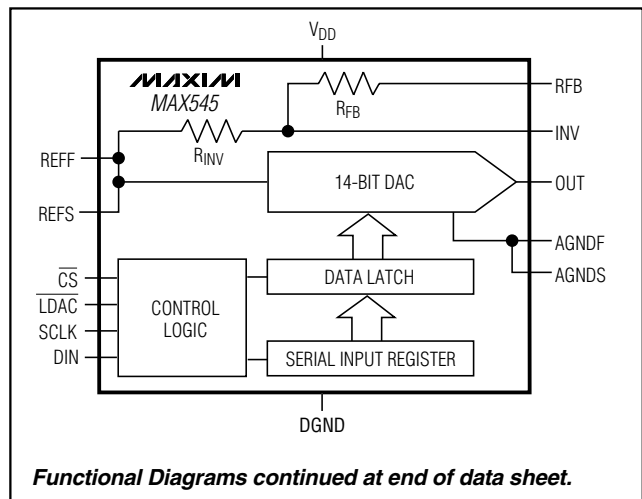

Functional Diagrams continued at end of data sheet.



For free samples & the latest literature: <http://www.maxim-ic.com>, or phone 1-800-998-8800.  
For small orders, phone 1-800-835-8769.

# +5V, Serial-Input, Voltage-Output, 14-Bit DACs

## ABSOLUTE MAXIMUM RATINGS

|  |                                   |   |                 |
|--|-----------------------------------|---|-----------------|
| V <sub>DD</sub> to DGND .....                          | -0.3V to +6V                      | 14-Pin Plastic DIP (derate 10.00mW/°C above +70°C)... | 800mW           |
| CS, SCLK, DIN, LDAC to DGND .....                      | -0.3V to +6V                      | 14-Pin SO (derate 8.33mW/°C above +70°C) .....        | 667mW           |
| REF, REFF, REFS to AGND .....                          | -0.3V to (V <sub>DD</sub> + 0.3V) | 14-Pin Ceramic SB (derate 10.00mW/°C above +70°C)...  | 800mW           |
| AGND, AGNDF, AGNDS to DGND .....                       | -0.3V to +0.3V                    | Operating Temperature Ranges                          |                 |
| OUT, INV to AGND DGND .....                            | -0.3V to V <sub>DD</sub>          | MAX544 _C_ A/MAX545 _C_ D .....                       | 0°C to +70°C    |
| RFB to AGND DGND .....                                 | -6V to +6V                        | MAX544 _E_ A/MAX545 _E_ D .....                       | -40°C to +85°C  |
| Maximum Current into Any Pin.....                      | 50mA                              | MAX545BMJD .....                                      | -55°C to +125°C |
| Continuous Power Dissipation (T <sub>A</sub> = +70°C)  |                                   | Storage Temperature Range .....                       | -65°C to +150°C |
| 8-Pin Plastic DIP (derate 9.09mW/°C above +70°C) ..... | 727mW                             | Lead Temperature (soldering, 10s) .....               | +300°C          |
| 8-Pin SO (derate 5.88mW/°C above +70°C) .....          | 471mW                             |   |                 |

Stresses beyond those listed under "Absolute Maximum Ratings" may cause permanent damage to the device. These are stress ratings only, and functional operation of the device at these or any other conditions beyond those indicated in the operational sections of the specifications is not implied. Exposure to absolute maximum rating conditions for extended periods may affect device reliability.

## ELECTRICAL CHARACTERISTICS

(V<sub>DD</sub> = +5V ± 5%, V<sub>REF</sub> = +2.5V, AGND = DGND = 0, T<sub>A</sub> = T<sub>MIN</sub> to T<sub>MAX</sub>, unless otherwise noted.)

| PARAMETER  | SYMBOL           | CONDITIONS  |                      | MIN   | TYP   | MAX  | UNITS  |
|--|------------------|---|----------------------|-------|-------|------|--------|
| <b>STATIC PERFORMANCE—ANALOG SECTION (R<sub>L</sub> = ∞)</b>                 |                  |   |                      |       |       |      |        |
| Resolution   | N                |   |                      | 14    |       |      | Bits   |
| Integral Nonlinearity  | INL              | V <sub>DD</sub> = 5V  | MAX54_A              | ±0.15 | ±0.5  |      | LSB    |
|  |                  |   | MAX54_B              | ±0.15 | ±1    |      |        |
| Differential Nonlinearity  | DNL              | Guaranteed monotonic  |                      |       | ±0.15 | ±0.9 | LSB    |
| Zero-Code Offset Error   | ZSE              |   |                      |       |       | ±0.6 | mV     |
| Zero-Code Tempco   | ZSTC             |   |                      |       | ±0.05 |      | ppm/°C |
| Gain Error (Note 1)  |                  |   |                      |       |       | ±5   | LSB    |
| Gain-Error Tempco  |                  |   |                      |       | ±0.1  |      | ppm/°C |
| DAC Output Resistance  | R <sub>OUT</sub> | (Note 2)  |                      |       | 6.25  |      | kΩ     |
| Bipolar Resistor Matching  |                  | MAX545  | RFB/R <sub>INV</sub> | 1.0   |       |      |        |
|  |                  |   | Ratio error          |       | ±0.03 |      | %      |
| Bipolar Zero Offset Error  |                  | MAX545  |                      |       |       | ±10  | LSB    |
| Bipolar Zero Tempco  | BZSTC            | MAX545  |                      |       | ±0.5  |      | ppm/°C |
| Power-Supply Rejection   | PSR              | 4.75V ≤ V <sub>DD</sub> ≤ 5.25V   |                      |       |       | ±1.0 | LSB    |
| <b>REFERENCE INPUT</b>   |                  |   |                      |       |       |      |        |
| Reference Input Range  | V <sub>REF</sub> | (Note 3)  |                      | 2.0   |       | 3.0  | V      |
| Reference Input Resistance (Note 4)  | R <sub>REF</sub> | Unipolar mode   |                      | 11.5  |       |      | kΩ     |
|  |                  | MAX545, bipolar mode  |                      | 9.0   |       |      |        |
| <b>DYNAMIC PERFORMANCE—ANALOG SECTION (R<sub>L</sub> = ∞, unipolar mode)</b> |                  |   |                      |       |       |      |        |
| Voltage-Output Slew Rate   | SR               | C <sub>L</sub> = 10pF (Note 5)  |                      |       | 25    |      | V/μs   |
| Output Settling Time   |                  | To ± 1/2LSB of FS, C <sub>L</sub> = 10pF  |                      |       | 1     |      | μs     |
| DAC Glitch Impulse   |                  | Major-carry transition  |                      |       | 10    |      | nVs    |
| Digital Feedthrough  |                  | Code = 0000 hex; $\overline{CS}$ = V <sub>DD</sub> ; $\overline{LDAC}$ = 0V; SCLK, DIN = 0V to V <sub>DD</sub> levels |                      |       | 10    |      | nVs    |

# +5V, Serial-Input, Voltage-Output, 14-Bit DACs

MAX544/MAX545

## ELECTRICAL CHARACTERISTICS (continued)

(V<sub>DD</sub> = +5V ± 5%, V<sub>REF</sub> = +2.5V, AGND = DGND = 0, T<sub>A</sub> = T<sub>MIN</sub> to T<sub>MAX</sub>, unless otherwise noted.)

| PARAMETER                                    | SYMBOL          | CONDITIONS  | MIN  | TYP  | MAX  | UNITS |
|--|-----------------|---|------|------|------|-------|
| <b>DYNAMIC PERFORMANCE—REFERENCE SECTION</b> |                 |   |      |      |      |       |
| Reference -3dB Bandwidth                     | BW              | Code = FFFC hex                                     |      | 1    |      | MHz   |
| Reference Feedthrough                        |                 | Code = 0000 hex, V <sub>REF</sub> = 1Vp-p at 100kHz |      | 1    |      | mVp-p |
| Signal-to-Noise Ratio                        | SNR             |   |      | 83   |      | dB    |
| Reference Input Capacitance                  | C <sub>IN</sub> | Code = 0000 hex                                     |      | 75   |      | pF    |
|  |                 | Code = FFFC hex                                     |      | 120  |      |       |
| <b>STATIC PERFORMANCE—DIGITAL INPUTS</b>     |                 |   |      |      |      |       |
| Input High Voltage                           | V <sub>IH</sub> |   | 2.4  |      |      | V     |
| Input Low Voltage                            | V <sub>IL</sub> |   |      |      | 0.8  | V     |
| Input Current                                | I <sub>IN</sub> | V <sub>IN</sub> = 0                                 |      |      | ±1   | μA    |
| Input Capacitance                            | C <sub>IN</sub> | (Note 6)  |      |      | 10   | pF    |
| Hysteresis Voltage                           | V <sub>H</sub>  |   |      | 0.40 |      | V     |
| <b>POWER SUPPLY</b>                          |                 |   |      |      |      |       |
| Positive Supply Range                        | V <sub>DD</sub> |   | 4.75 |      | 5.25 | V     |
| Positive Supply Current                      | I <sub>DD</sub> |   |      | 0.3  | 1.1  | mA    |
| Power Dissipation                            | PD              |   |      | 1.5  |      | mW    |

## TIMING CHARACTERISTICS

(V<sub>DD</sub> = +5V ± 5%, V<sub>REF</sub> = +2.5V, AGND = DGND = 0, CMOS inputs, T<sub>A</sub> = T<sub>MIN</sub> to T<sub>MAX</sub>, unless otherwise noted.)

| PARAMETER   | SYMBOL             | CONDITIONS      | MIN | TYP | MAX | UNITS |
|---|--------------------|-----------------|-----|-----|-----|-------|
| SCLK Frequency  | f <sub>SCLK</sub>  |                 |     |     | 10  | MHz   |
| SCLK Pulse Width High   | t <sub>CH</sub>    |                 | 45  |     |     | ns    |
| SCLK Pulse Width Low  | t <sub>CL</sub>    |                 | 45  |     |     | ns    |
| $\overline{\text{CS}}$ Low to SCLK High Setup                       | t <sub>CSS0</sub>  |                 | 45  |     |     | ns    |
| $\overline{\text{CS}}$ High to SCLK High Setup                      | t <sub>CSS1</sub>  |                 | 45  |     |     | ns    |
| SCLK High to $\overline{\text{CS}}$ Low Hold                        | t <sub>CSH0</sub>  | (Note 6)        | 30  |     |     | ns    |
| SCLK High to $\overline{\text{CS}}$ High Hold                       | t <sub>CSH1</sub>  |                 | 45  |     |     | ns    |
| DIN to SCLK High Setup  | t <sub>DS</sub>    |                 | 40  |     |     | ns    |
| DIN to SCLK High Hold   | t <sub>DH</sub>    |                 | 0   |     |     | ns    |
| $\overline{\text{LDAC}}$ Pulse Width                                | t <sub>LDAC</sub>  | MAX545          | 50  |     |     | ns    |
| $\overline{\text{CS}}$ High to $\overline{\text{LDAC}}$ Low Setup   | t <sub>LDACS</sub> | MAX545 (Note 6) | 50  |     |     | ns    |
| V <sub>DD</sub> High to $\overline{\text{CS}}$ Low (power-up delay) |                    |                 |     | 20  |     | μs    |

**Note 1:** Gain Error tested at V<sub>REF</sub> = 2.0V, 2.5V, and 3.0V.

**Note 2:** R<sub>OUT</sub> tolerance is typically ±20%.

**Note 3:** Min/max range guaranteed by gain-error test. Operation outside min/max limits will result in degraded performance.

**Note 4:** Reference input resistance is code dependent, minimum at 8554 hex.

**Note 5:** Slew-rate value is measured from 0% to 63%.

**Note 6:** Guaranteed by design. Not production tested.

# +5V, Serial-Input, Voltage-Output, 14-Bit DACs

## Typical Operating Characteristics

( $V_{DD} = 5V$ ,  $V_{REF} = +2.5V$ ,  $T_A = +25^\circ C$ , unless otherwise noted.)

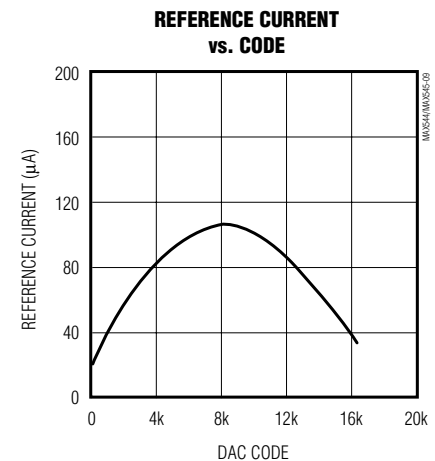
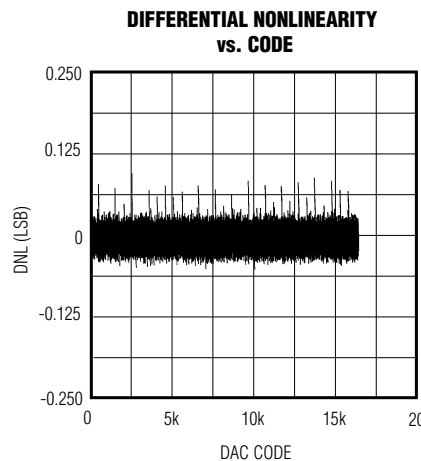
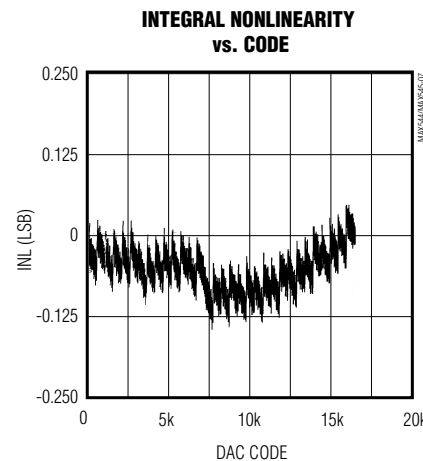
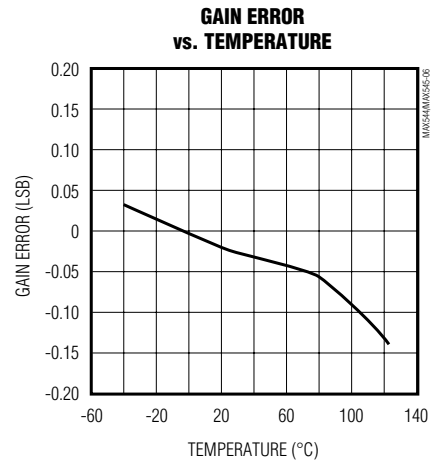
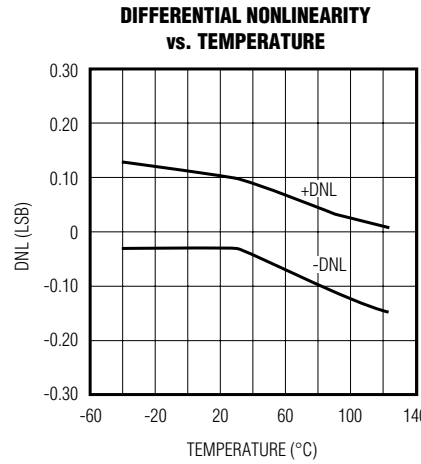
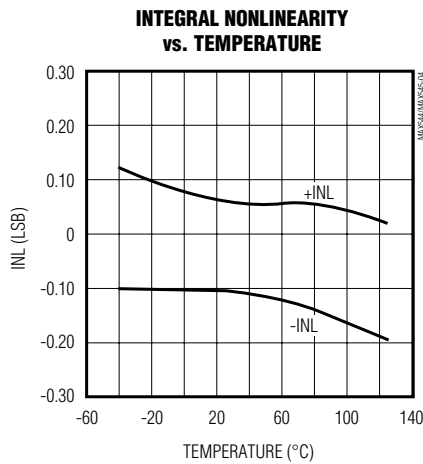
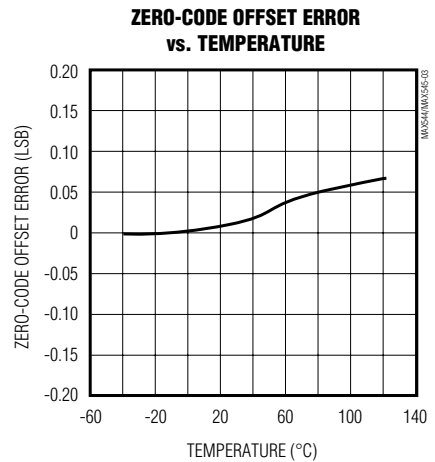
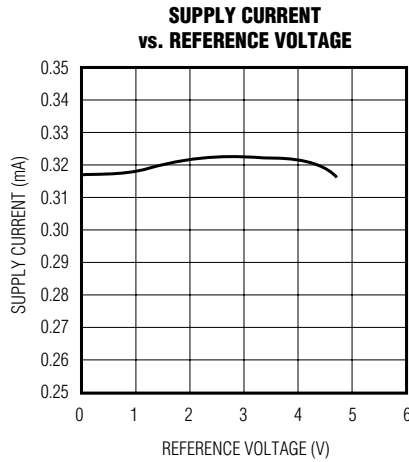
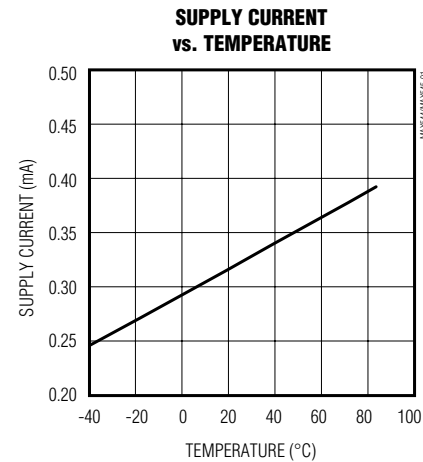

# +5V, Serial-Input, Voltage-Output, 14-Bit DACs

MAX544/MAX545

## Typical Operating Characteristics (continued)

(V<sub>DD</sub> = +5V, V<sub>REF</sub> = +2.5V, T<sub>A</sub> = +25°C, unless otherwise noted.)

**FULL-SCALE STEP RESPONSE**  
(f<sub>SCLK</sub> = 10MHz)

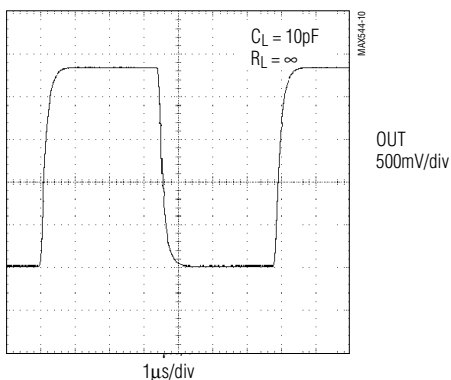

**FULL-SCALE STEP RESPONSE**  
(f<sub>SCLK</sub> = 20MHz)

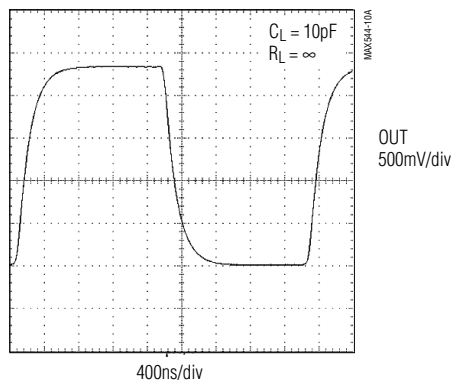

**MAJOR-CARRY OUTPUT GLITCH**

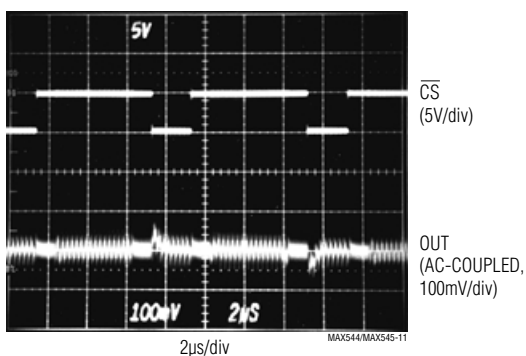

**DIGITAL FEEDTHROUGH**

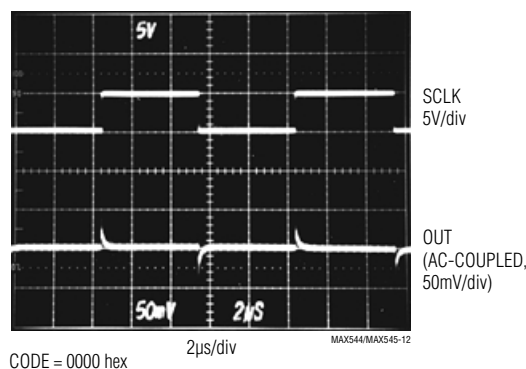

## Pin Descriptions

### MAX544

| PIN | NAME                   | FUNCTION  |
|-----|------------------------|---|
| 1   | OUT                    | DAC Output Voltage  |
| 2   | AGND                   | Analog Ground   |
| 3   | REF                    | Voltage Reference Input. Connect to external +2.5V reference. |
| 4   | $\overline{\text{CS}}$ | Chip-Select Input   |
| 5   | SCLK                   | Serial-Clock Input. Duty cycle must be between 40% and 60%.   |
| 6   | DIN                    | Serial-Data Input   |
| 7   | DGND                   | Digital Ground  |
| 8   | V <sub>DD</sub>        | +5V Supply Voltage  |

# +5V, Serial-Input, Voltage-Output, 14-Bit DACs

## Pin Descriptions (continued)

### MAX545

| PIN | NAME                     | FUNCTION  |
|-----|--------------------------|---|
| 1   | RFB                      | Feedback Resistor. Connect to external op amp's output in bipolar mode.                               |
| 2   | OUT                      | DAC Output Voltage  |
| 3   | AGNDF                    | Analog Ground (force)   |
| 4   | AGNDS                    | Analog Ground (sense)   |
| 5   | REFS                     | Voltage Reference Input (sense). Connect REFS to external +2.5V reference.                            |
| 6   | REFF                     | Voltage Reference Input (force). Connect REFF to external +2.5V reference.                            |
| 7   | $\overline{\text{CS}}$   | Chip-Select Input   |
| 8   | SCLK                     | Serial-Clock Input. Duty cycle must be between 40% and 60%.   |
| 9   | N.C.                     | No Connection. Not internally connected.  |
| 10  | DIN                      | Serial-Data Input   |
| 11  | $\overline{\text{LDAC}}$ | $\overline{\text{LDAC}}$ Input. A falling edge updates the internal DAC latch.                        |
| 12  | DGND                     | Digital Ground  |
| 13  | INV                      | Junction of internal scaling resistors. Connect to external op amp's inverting input in bipolar mode. |
| 14  | VDD                      | +5V Supply Voltage  |

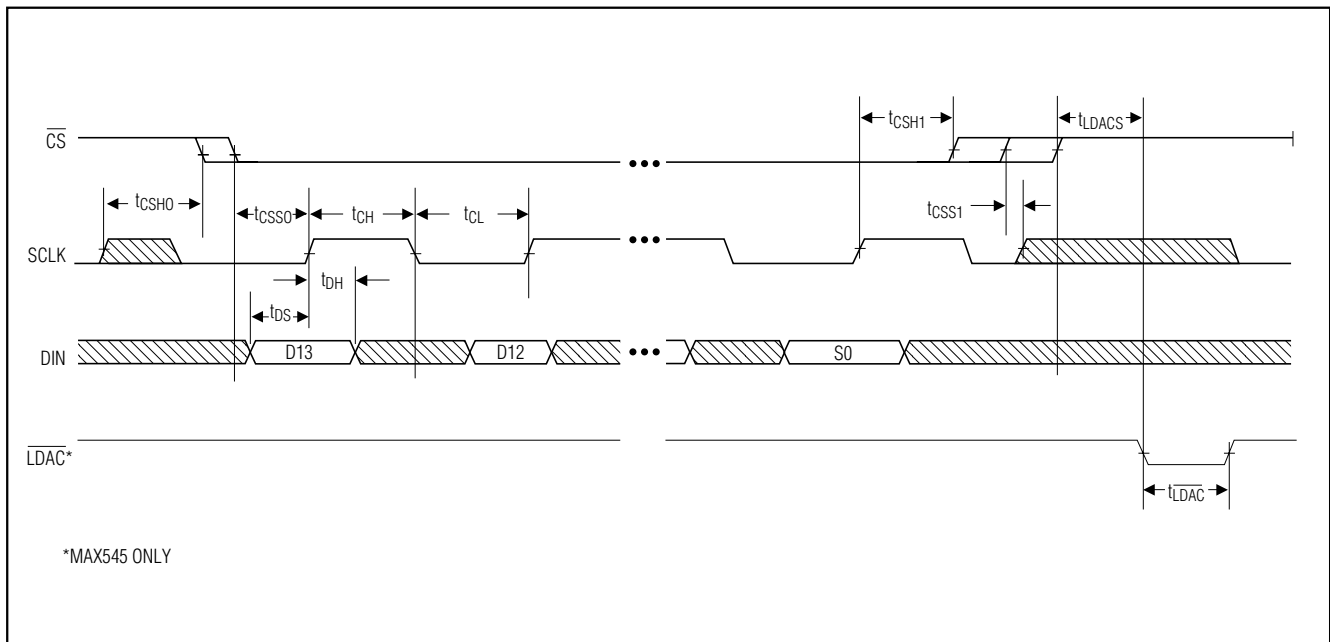

Figure 1. Timing Diagram

# +5V, Serial-Input, Voltage-Output, 14-Bit DACs

**MAX544/MAX545**

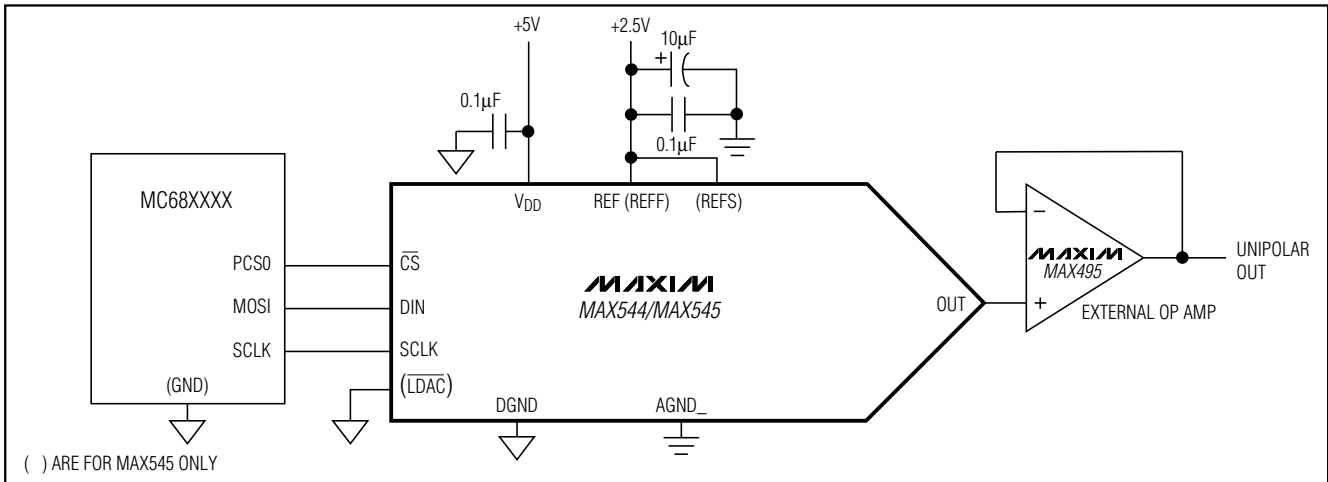

Figure 2a. Typical Operating Circuit—Unipolar Output

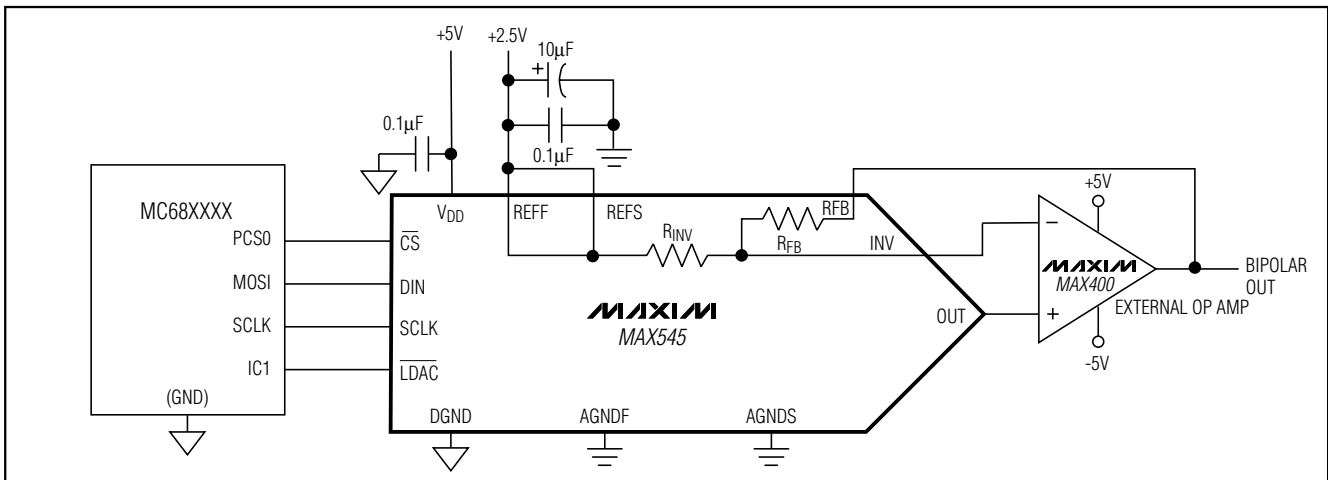

Figure 2b. Typical Operating Circuit—Bipolar Output

## Detailed Description

The MAX544/MAX545 voltage-output, 14-bit digital-to-analog converters (DACs) offer full 14-bit performance with less than 0.5LSB integral linearity error and less than 0.9LSB differential linearity error, thus ensuring monotonic performance. Serial-data transfer minimizes the number of package pins required.

The MAX544/MAX545 are composed of two matched DAC sections, with an inverted R-2R DAC forming the LSBs and the four MSBs derived from 15 identically matched resistors. This architecture allows the lowest glitch energy to be transferred to the DAC output on

major-carry transitions. It also lowers the DAC output impedance by a factor of eight compared to a standard R-2R ladder, allowing unbuffered operation in medium-load applications.

The MAX545 provides matched bipolar offset resistors, which connect to an external op amp for bipolar output swings (Figure 2b). For optimum performance, the MAX545 also provides a set of Kelvin connections to the voltage-reference and analog-ground inputs.



# +5V, Serial-Input, Voltage-Output, 14-Bit DACs

## Digital Interface

The MAX544/MAX545's digital interface is a standard 3-wire connection compatible with SPI/QSPI/MICROWIRE interfaces. The chip-select input ( $\overline{CS}$ ) frames the serial data loading at the data-input pin (DIN). Immediately following  $\overline{CS}$ 's high-to-low transition, the data is shifted synchronously and latched into the input register on the rising edge of the serial clock input (SCLK). After 16 bits (14 data bits, plus 2 sub-bits set to zero) have been loaded into the serial input register, it transfers its contents to the DAC latch on  $\overline{CS}$ 's low-to-high transition (Figure 3a). Note that if  $\overline{CS}$  is not kept low during the entire 16 SCLK cycles, data will be corrupted. In this case, reload the DAC latch with a new 16-bit word.

Alternatively, for the MAX545,  $\overline{LDAC}$  allows the DAC latch to update asynchronously by pulling  $\overline{LDAC}$  low after  $\overline{CS}$  goes high (Figure 3b). Hold  $\overline{LDAC}$  high during the data-loading sequence.

## External Reference

The MAX544/MAX545 operate with external voltage references from 2V to 3V. The reference voltage determines the DAC's full-scale output voltage. Kelvin connections are provided with the MAX545 for optimum performance. The 2.5V MAX873A, with  $\pm 15\text{mV}$  initial accuracy and a  $7\text{ppm}/^\circ\text{C}$  (max) temperature coefficient, is a good choice.

## Power-On Reset

The MAX544/MAX545 have a power-on reset circuit to set the DAC's output to 0V in unipolar mode when  $V_{DD}$  is first applied. This ensures that unwanted DAC output voltages will not occur immediately following a system power-up, such as after a loss of power. In bipolar mode, the DAC output is set to  $-V_{REF}$ .

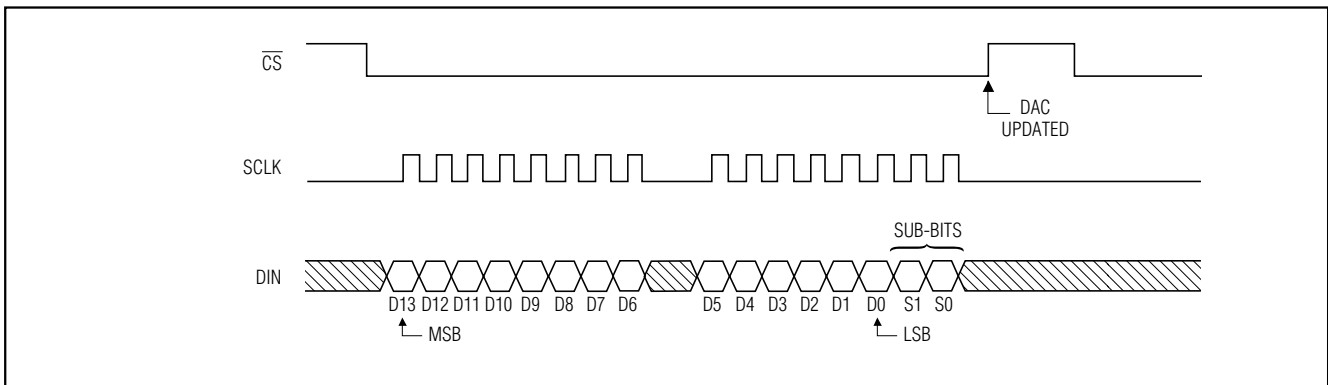

Figure 3a. MAX544/MAX545 3-Wire Interface Timing Diagram ( $\overline{LDAC} = \text{DGND}$  for MAX545)

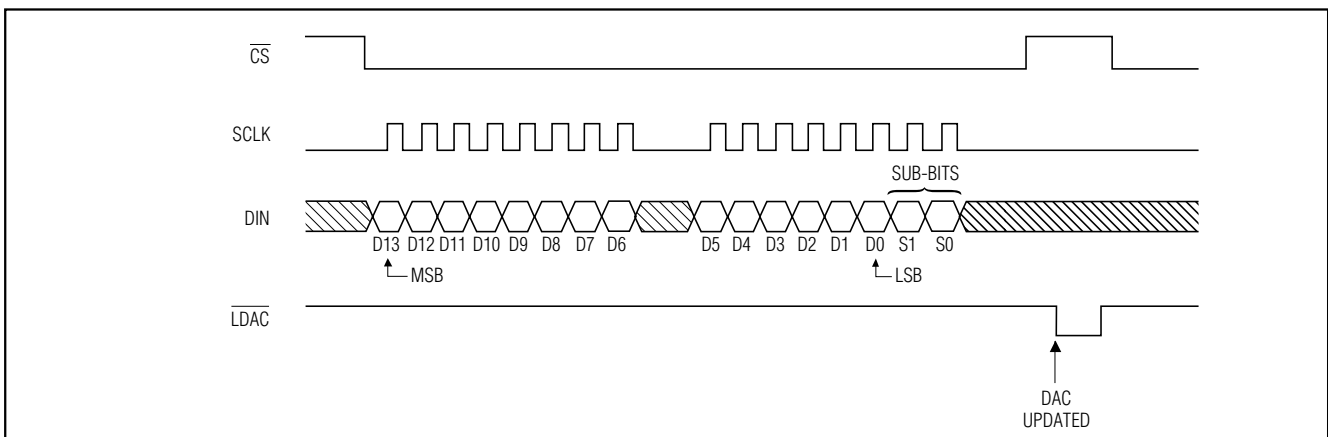

Figure 3b. MAX545 4-Wire Interface Timing Diagram

# +5V, Serial-Input, Voltage-Output, 14-Bit DACs

## Applications Information

### Reference and Analog Ground Inputs

The MAX544/MAX545 operate with external voltage references from 2V to 3V, and maintain 14-bit performance if certain guidelines are followed when selecting and applying the reference. Ideally, the reference's temperature coefficient should be less than 1.5ppm/°C to maintain 14-bit accuracy to within 1LSB over the 0°C to +70°C commercial temperature range. Since this converter is designed as an inverted R-2R voltage-mode DAC, the input resistance seen by the voltage reference is code dependent. The worst-case input-resistance variation is from 11.5k $\Omega$  (at code 8554 hex) to 200k $\Omega$  (at code 0000 hex). The maximum change in load current for a +2.5V reference is  $+2.5V / 11.5k\Omega = 217\mu A$ ; therefore, the required load regulation is 28ppm/mA for a maximum error of 0.1LSB. This implies a reference output impedance of less than 71m $\Omega$ . In addition, the signal-path impedance from the voltage reference to the reference input must be kept low because it contributes directly to the load-regulation error.

The requirement for a low-impedance voltage reference is met with capacitor bypassing at the reference inputs and ground. A 0.1 $\mu F$  ceramic capacitor with short leads between REFF and AGNDF (MAX545), or REF and AGND (MAX544), provides high-frequency bypassing. A surface-mount ceramic chip capacitor is preferred because it has the lowest inductance. An additional 10 $\mu F$  between REFF and AGNDF (MAX545), or REF and AGND (MAX544), provides low-frequency bypassing. A low-ESR tantalum, film, or organic semiconductor capacitor works well. Leaded capacitors are acceptable because impedance is not as critical at lower frequencies. The circuit can benefit from even larger bypassing capacitors, depending on the stability of the external reference with capacitive loading. If separate force and sense lines are not used, tie the appropriate force and sense pins together close to the package.

AGND must also be low impedance, as load-regulation errors will be introduced by excessive AGND resistance. As in all high-resolution, high-accuracy applications, separate analog and digital ground planes yield the best results. Tie DGND to AGND at the AGND pin to form the "star" ground for the DAC system. Always refer remote DAC loads to this system ground for the best possible performance.

### Unbuffered Operation

Unbuffered operation reduces power consumption as well as offset error contributed by the external output buffer. The R-2R DAC output is available directly at OUT, allowing 14-bit performance from +VREF to AGND without degradation at zero scale. The DAC's output impedance is also low enough to drive medium loads ( $R_L > 60k\Omega$ ) without degradation of INL or DNL; only the gain error is increased by externally loading the DAC output.

### External Output Buffer Amplifier

The requirements on the external output buffer amplifier change whether the DAC is used in unipolar or bipolar operational mode. In unipolar mode, the output amplifier is used in a voltage-follower connection. In bipolar mode (MAX545 only), the amplifier operates with the internal scaling resistors (Figure 2b). In each mode, the DAC's output resistance is constant and is independent of input code; however, the output amplifier's input impedance should still be as high as possible to minimize gain errors. The DAC's output capacitance is also independent of input code, thus simplifying stability requirements on the external amplifier.

In bipolar mode, a precision amplifier operating with dual power supplies (such as the MAX400) provides the  $\pm V_{REF}$  output range. In single-supply applications, precision amplifiers with input common-mode ranges including AGND are available; however, their output swings do not normally include the negative rail (AGND) without significant degradation of performance. A single-supply op amp, such as the MAX495, is suitable if the application does not use codes near zero.

Since the LSBs for a 14-bit DAC are extremely small (152.6 $\mu V$  for  $V_{REF} = 2.5V$ ), pay close attention to the external amplifier's input specification. The input offset voltage can degrade the zero-scale error and might require an output offset trim to maintain full accuracy if the offset voltage is greater than 1/2LSB. Similarly, the input bias current multiplied by the DAC output resistance (typically 6.25k $\Omega$ ) contributes to zero-scale error. Temperature effects also must be taken into consideration. Over the 0°C to +70°C commercial temperature range, the offset voltage temperature coefficient (referenced to +25°C) must be less than 1.7 $\mu V/^\circ C$  to add less than 1/2LSB of zero-scale error. The external

## +5V, Serial-Input, Voltage-Output, 14-Bit DACs

amplifier's input resistance forms a resistive divider with the DAC output resistance, which results in a gain error. To contribute less than 1/2LSB of gain error, the input resistance typically must be greater than:

$$6.25\text{k}\Omega \div \frac{1}{2} \left[ \frac{1}{2^{14}} \right] = 205\text{M}\Omega$$

The settling time is affected by the buffer input capacitance, the DAC's output capacitance, and PC board capacitance. The typical DAC output voltage settling time is 1 $\mu$ s for a full-scale step. Settling time can be significantly less for smaller step changes. Assuming a single time-constant exponential settling response, a full-scale step takes 10.4 time constants to settle to within 1/2LSB of the final output voltage. The time constant is equal to the DAC output resistance multiplied by the total output capacitance. The DAC output capacitance is typically 10pF. Any additional output capacitance increases the settling time.

The external buffer amplifier's gain-bandwidth product is important because it increases the settling time by adding another time constant to the output response. The effective time constant of two cascaded systems, each with a single time-constant response, is approximately the root square sum of the two time constants. The DAC output's time constant is 1 $\mu$ s / 10.4 = 96ns, ignoring the effect of additional capacitance. If the time constant of an external amplifier with 1MHz bandwidth is 1 / 2 $\pi$  (1MHz) = 159ns, then the effective time constant of the combined system is:

$$\sqrt{(96\text{ns})^2 + (159\text{ns})^2} = 186\text{ns}$$

This suggests that the settling time to within 1/2LSB of the final output voltage, including the external buffer amplifier, will be approximately 10.4 • 186ns = 1.93 $\mu$ s.

### Digital Inputs and Interface Logic

The digital interface for the 14-bit DAC is based on a 3-wire standard that is compatible with SPI, QSPI, and MICROWIRE interfaces. The three digital inputs ( $\overline{\text{CS}}$ , DIN, and SCLK) load the digital input data serially into the DAC. LDAC (MAX545) updates the DAC output asynchronously.

All of the digital inputs include Schmitt-trigger buffers to accept slow-transition interfaces. This means that optocouplers can interface directly to the MAX544/MAX545 without additional external logic. The digital inputs are compatible with TTL/CMOS-logic levels.

### Unipolar Configuration

Figure 2a shows the MAX544/MAX545 configured for unipolar operation with an external op amp. The op amp is set for unity gain, and Table 1 lists the codes for this circuit.

### Bipolar Configuration

Figure 2b shows the MAX545 configured for bipolar operation with an external op amp. The op amp is set for unity gain with an offset of -1/2V<sub>REF</sub>. Table 2 shows the offset binary codes for this circuit.

### Power-Supply Bypassing and Ground Management

For optimum system performance, use PC boards with separate analog and digital ground planes. Wire-wrap boards are not recommended. Connect the two ground planes together at the low-impedance power-supply source. Connect DGND and AGND together at the IC. The best ground connection can be achieved by connecting the DAC's DGND and AGND pins together and connecting that point to the system analog ground plane. If the DAC's DGND is connected to the system digital ground, digital noise may get through to the DAC's analog portion.

Bypass V<sub>DD</sub> with a 0.1 $\mu$ F ceramic capacitor connected between V<sub>DD</sub> and AGND. Mount it with short leads close to the device. Ferrite beads can also be used to further isolate the analog and digital power supplies.

**Table 1. Unipolar Code Table**

| DAC LATCH CONTENTS    |     | ANALOG OUTPUT, V <sub>OUT</sub>                          |
|-----------------------|-----|--|
| MSB                   | LSB |  |
| 1111 1111 1111 11(00) |     | V <sub>REF</sub> • (16,383 / 16,384)                     |
| 1000 0000 0000 00(00) |     | V <sub>REF</sub> • (8192 / 16,384) = 1/2V <sub>REF</sub> |
| 0000 0000 0000 01(00) |     | V <sub>REF</sub> • (1 / 16,384)                          |
| 0000 0000 0000 00(00) |     | 0V   |

**Table 2. Bipolar Code Table**

| DAC LATCH CONTENTS    |     | ANALOG OUTPUT, V <sub>OUT</sub>                       |
|-----------------------|-----|---|
| MSB                   | LSB |   |
| 1111 1111 1111 11(00) |     | +V <sub>REF</sub> • (8191 / 8192)                     |
| 1000 0000 0000 01(00) |     | +V <sub>REF</sub> • (1 / 8192)                        |
| 1000 0000 0000 00(00) |     | 0V  |
| 0111 1111 1111 11(00) |     | -V <sub>REF</sub> • (1 / 8192)                        |
| 0000 0000 0000 00(00) |     | -V <sub>REF</sub> • (8192 / 8192) = -V <sub>REF</sub> |

( ) = Sub-bits

# +5V, Serial-Input, Voltage-Output, 14-Bit DACs

**MAX544/MAX545**

## Ordering Information (continued)

| PART               | TEMP. RANGE     | PIN-PACKAGE    | INL (LSB) |
|--------------------|-----------------|----------------|-----------|
| MAX544AEPA         | -40°C to +85°C  | 8 Plastic DIP  | ±1/2      |
| MAX544BEPA         | -40°C to +85°C  | 8 Plastic DIP  | ±1        |
| MAX544AESA         | -40°C to +85°C  | 8 SO           | ±1/2      |
| MAX544BESA         | -40°C to +85°C  | 8 SO           | ±1        |
| <b>MAX545</b> ACPD | 0°C to +70°C    | 14 Plastic DIP | ±1/2      |
| MAX545BCPD         | 0°C to +70°C    | 14 Plastic DIP | ±1        |
| MAX545ACSD         | 0°C to +70°C    | 14 SO          | ±1/2      |
| MAX545BCSD         | 0°C to +70°C    | 14 SO          | ±1        |
| MAX545AEPD         | -40°C to +85°C  | 14 Plastic DIP | ±1/2      |
| MAX545BEPD         | -40°C to +85°C  | 14 Plastic DIP | ±1        |
| MAX545AESD         | -40°C to +85°C  | 14 SO          | ±1/2      |
| MAX545BESD         | -40°C to +85°C  | 14 SO          | ±1        |
| MAX545BMJD         | -55°C to +125°C | 14 Ceramic SB* | ±1        |

\*Contact factory for availability.

## Functional Diagrams (continued)

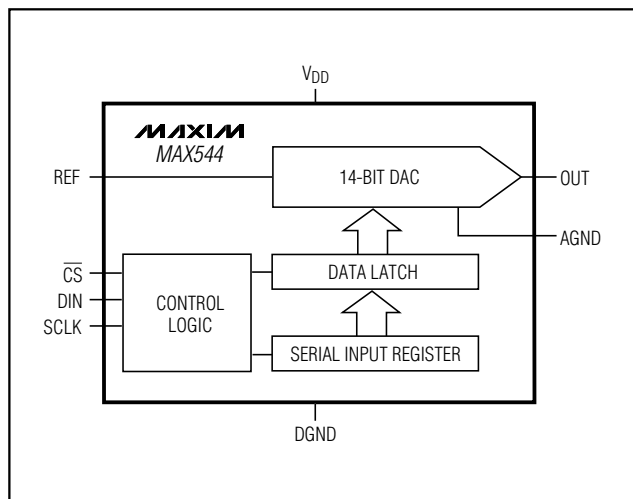

## Chip Information

TRANSISTOR COUNT: 2209

# +5V, Serial-Input, Voltage-Output, 14-Bit DACs

## Package Information

|    | INCHES |       | MILLIMETERS |      |
|----|--------|-------|-------------|------|
|    | MIN    | MAX   | MIN         | MAX  |
| A  | 0.053  | 0.069 | 1.35        | 1.75 |
| A1 | 0.004  | 0.010 | 0.10        | 0.25 |
| B  | 0.014  | 0.019 | 0.35        | 0.49 |
| C  | 0.007  | 0.010 | 0.19        | 0.25 |
| e  | 0.050  |       | 1.27        |      |
| E  | 0.150  | 0.157 | 3.80        | 4.00 |
| H  | 0.228  | 0.244 | 5.80        | 6.20 |
| h  | 0.010  | 0.020 | 0.25        | 0.50 |
| L  | 0.016  | 0.050 | 0.40        | 1.27 |

|   | INCHES |       | MILLIMETERS |       | N  | MS012 |
|---|--------|-------|-------------|-------|----|-------|
|   | MIN    | MAX   | MIN         | MAX   |    |       |
| D | 0.189  | 0.197 | 4.80        | 5.00  | 8  | A     |
| D | 0.337  | 0.344 | 8.55        | 8.75  | 14 | B     |
| D | 0.386  | 0.394 | 9.80        | 10.00 | 16 | C     |

NOTES:  
 1. DAE DO NOT INCLUDE MOLD FLASH  
 2. MOLD FLASH OR PROTRUSIONS NOT TO EXCEED .15mm (.006")  
 3. LEADS TO BE COPLANAR WITHIN .02mm (.004")  
 4. CONTROLLING DIMENSION: MILLIMETER  
 5. MEETS JEDEC MS012-XX AS SHOWN IN ABOVE TABLE  
 6. N = NUMBER OF PINS

MAXIM INTEGRATED PRODUCTS PACKAGE FAMILY OUTLINE: SOIC .150° 1/1 21-0041 A

|    | INCHES |       | MILLIMETERS |       |
|----|--------|-------|-------------|-------|
|    | MIN    | MAX   | MIN         | MAX   |
| A  | ---    | 0.180 | ---         | 4.572 |
| A1 | 0.020  | ---   | 0.508       | ---   |
| A2 | 0.125  | 0.175 | 3.18        | 4.45  |
| A3 | 0.055  | 0.080 | 1.40        | 2.03  |
| B  | 0.015  | 0.021 | 0.381       | 0.533 |
| B1 | 0.045  | 0.060 | 1.14        | 1.524 |
| C  | 0.009  | 0.014 | 0.229       | 0.355 |
| D1 | 0.005  | 0.080 | 0.13        | 2.03  |
| E  | 0.300  | 0.325 | 7.62        | 8.255 |
| E1 | 0.275  | 0.295 | 6.985       | 7.493 |
| e  | 0.100  | ---   | 2.54        | ---   |
| eA | 0.300  | ---   | 7.62        | ---   |
| eB | ---    | 0.400 | ---         | 10.16 |
| L  | 0.115  | 0.150 | 2.921       | 3.81  |

|   | INCHES |       | MILLIMETERS |       | N  | MS001 |
|---|--------|-------|-------------|-------|----|-------|
|   | MIN    | MAX   | MIN         | MAX   |    |       |
| D | 0.348  | 0.390 | 8.84        | 9.91  | 8  | AB    |
| D | 0.735  | 0.765 | 18.67       | 19.43 | 14 | AC    |
| D | 0.745  | 0.765 | 18.92       | 19.43 | 16 | AA    |
| D | 0.885  | 0.915 | 22.48       | 23.24 | 18 | AD    |
| D | 1.015  | 1.045 | 25.78       | 26.54 | 20 | AE    |
| D | 1.14   | 1.265 | 28.96       | 32.13 | 24 | AF    |
| D | 1.360  | 1.380 | 34.54       | 35.05 | 28 | *5    |

NOTES:  
 1. DAE DO NOT INCLUDE MOLD FLASH  
 2. MOLD FLASH OR PROTRUSIONS NOT TO EXCEED .15mm (.006")  
 3. CONTROLLING DIMENSION: MILLIMETER  
 4. MEETS JEDEC MS001-XX AS SHOWN IN ABOVE TABLE  
 5. SIMILAR TO JEDEC MS-095-AH  
 6. N = NUMBER OF PINS

MAXIM INTEGRATED PRODUCTS PACKAGE FAMILY OUTLINE: PDIP .300° 1/1 21-0043 B

Maxim cannot assume responsibility for use of any circuitry other than circuitry entirely embodied in a Maxim product. No circuit patent licenses are implied. Maxim reserves the right to change the circuitry and specifications without notice at any time.

12 Maxim Integrated Products, 120 San Gabriel Drive, Sunnyvale, CA 94086 408-737-7600