



Chipsmall Limited consists of a professional team with an average of over 10 year of expertise in the distribution of electronic components. Based in Hongkong, we have already established firm and mutual-benefit business relationships with customers from,Europe,America and south Asia,supplying obsolete and hard-to-find components to meet their specific needs.

With the principle of "Quality Parts,Customers Priority,Honest Operation,and Considerate Service",our business mainly focus on the distribution of electronic components. Line cards we deal with include Microchip,ALPS,ROHM,Xilinx,Pulse,ON,Everlight and Freescale. Main products comprise IC,Modules,Potentiometer,IC Socket,Relay,Connector.Our parts cover such applications as commercial,industrial, and automotives areas.

We are looking forward to setting up business relationship with you and hope to provide you with the best service and solution. Let us make a better world for our industry!



Contact us

Tel: +86-755-8981 8866 Fax: +86-755-8427 6832

Email & Skype: info@chipsmall.com Web: www.chipsmall.com

Address: A1208, Overseas Decoration Building, #122 Zhenhua RD., Futian, Shenzhen, China



Ultra-High-Precision, Ultra-Low-Noise, Series Voltage Reference

General Description

The MAX6126 is an ultra-low-noise, high-precision, low-dropout voltage reference. This family of voltage references feature curvature-correction circuitry and high-stability, laser-trimmed, thin-film resistors that result in 3ppm/°C (max) temperature coefficients and an excellent $\pm 0.02\%$ (max) initial accuracy. The proprietary low-noise reference architecture produces a low flicker noise of 1.3 $\mu\text{V}_{\text{P-P}}$ and wideband noise as low as 60nV/ $\sqrt{\text{Hz}}$ (2.048V output) without the increased supply current usually found in low-noise references. Improve wideband noise to 35nV/ $\sqrt{\text{Hz}}$ and AC power-supply rejection by adding a 0.1 μF capacitor at the noise reduction pin. The MAX6126 series mode reference operates from a wide 2.7V to 12.6V supply voltage range and load-regulation specifications are guaranteed to be less than 0.025 Ω for sink and source currents up to 10mA. These devices are available over the automotive temperature range of -40°C to +125°C.

The MAX6126 typically draws 380 μA of supply current and is available in 2.048V, 2.500V, 2.800V, 3.000V, 4.096V, and 5.000V output voltages. These devices also feature dropout voltages as low as 200mV. Unlike conventional shunt-mode (two-terminal) references that waste supply current and require an external resistor, the MAX6126 offers supply current that is virtually independent of supply voltage and does not require an external resistor. The MAX6126 is stable with 0.1 μF to 10 μF of load capacitance.

The MAX6126 is available in the tiny 8-pin $\mu\text{MAX}^{\text{®}}$, as well as 8-pin SO packages.

Applications

- High-Resolution A/D and D/A Converters
- ATE Equipment
- High-Accuracy Reference Standard
- Precision Current Sources
- Digital Voltmeters
- High-Accuracy Industrial and Process Control

μMAX is a registered trademark of Maxim Integrated Products, Inc.

Features

- ◆ Ultra-Low 1.3 $\mu\text{V}_{\text{P-P}}$ Noise (0.1Hz to 10Hz, 2.048V Output)
- ◆ Ultra-Low 3ppm/°C (max) Temperature Coefficient
- ◆ $\pm 0.02\%$ (max) Initial Accuracy
- ◆ Wide ($V_{\text{OUT}} + 200\text{mV}$) to 12.6V Supply Voltage Range
- ◆ Low 200mV (max) Dropout Voltage
- ◆ 380 μA Quiescent Supply Current
- ◆ 10mA Sink/Source-Current Capability
- ◆ Stable with $C_{\text{LOAD}} = 0.1\mu\text{F}$ to 10 μF
- ◆ Low 20ppm/1000hr Long-Term Stability
- ◆ 0.025 Ω (max) Load Regulation
- ◆ 20 $\mu\text{V}/\text{V}$ (max) Line Regulation
- ◆ Force and Sense Outputs for Remote Sensing

Pin Configuration

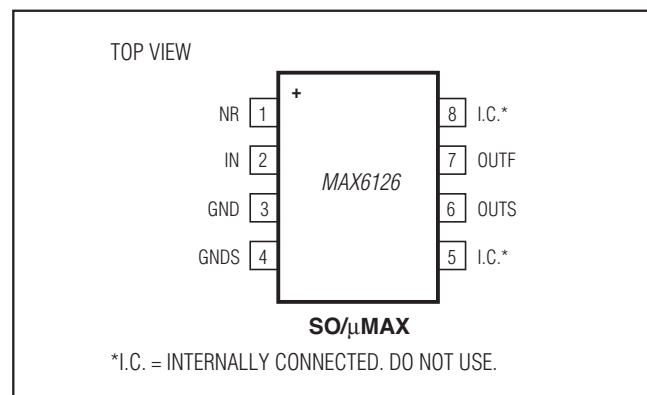

Ordering Information

| PART | TEMP RANGE | PIN-PACKAGE | OUTPUT VOLTAGE (V) | MAXIMUM INITIAL ACCURACY (%) | MAXIMUM TEMPCO (-40°C to +85°C) (ppm/°C) |
|----------------|-----------------|-------------------|--------------------|------------------------------|--|
| MAX6126AASA21+ | -40°C to +125°C | 8 SO | 2.048 | 0.02 | 3 |
| MAX6126BASA21+ | -40°C to +125°C | 8 SO | 2.048 | 0.06 | 5 |
| MAX6126A21+ | -40°C to +125°C | 8 μMAX | 2.048 | 0.06 | 3 |

Ordering Information continued at end of data sheet.

+Denotes a lead(Pb)-free/RoHS-compliant package.

For pricing, delivery, and ordering information, please contact Maxim Direct at 1-888-629-4642, or visit Maxim's website at www.maximintegrated.com.

MAX6126

Ultra-High-Precision, Ultra-Low-Noise, Series Voltage Reference

ABSOLUTE MAXIMUM RATINGS

(All voltages referenced to GND)

| | |
|---|--|
| GNDS | -0.3V to +0.3V |
| IN | -0.3V to +13V |
| OUTF, OUTS, NR..... | -0.3V to the lesser of (V _{IN} + 0.3V) or +6V |
| Output Short Circuit to GND or IN | 60s |
| Continuous Power Dissipation (T _A = +70°C) | |
| 8-Pin μ MAX (derate 4.5mW/°C above +70°C) | 362mW |
| 8-Pin SO (derate 5.88mW/°C above +70°C) | 471mW |

| | |
|---|-----------------|
| Operating Temperature Range | -40°C to +125°C |
| Junction Temperature | +150°C |
| Storage Temperature Range | -65°C to +150°C |
| Lead Temperature (soldering, 10s) | +300°C |
| Soldering Temperature (reflow) | +260°C |

Stresses beyond those listed under "Absolute Maximum Ratings" may cause permanent damage to the device. These are stress ratings only, and functional operation of the device at these or any other conditions beyond those indicated in the operational sections of the specifications is not implied. Exposure to absolute maximum rating conditions for extended periods may affect device reliability.

ELECTRICAL CHARACTERISTICS—MAX6126_21 (V_{OUT} = 2.048V)

(V_{IN} = 5V, C_{LOAD} = 0.1 μ F, I_{OUT} = 0, T_A = T_{MIN} to T_{MAX}, unless otherwise noted. Typical values are at T_A = +25°C.)

| PARAMETER | SYMBOL | CONDITIONS | MIN | TYP | MAX | UNITS |
|---|---------------------------------|--|----------------------------------|-------|-------|----------------|
| OUTPUT | | | | | | |
| Output Voltage | V _{OUT} | T _A = +25°C | | 2.048 | | V |
| Output Voltage Accuracy | | Referred to V _{OUT} , T _A = +25°C | A grade SO | -0.02 | +0.02 | % |
| | | | B grade SO | -0.06 | +0.06 | |
| | | | A grade μ MAX | -0.06 | +0.06 | |
| | | | B grade μ MAX | -0.1 | +0.1 | |
| Output Voltage Temperature Coefficient (Note 1) | TCV _{OUT} | T _A = -40°C to +85°C | A grade SO | 0.5 | 3 | ppm/°C |
| | | | B grade SO | 1 | 5 | |
| | | | A grade μ MAX | 1 | 3 | |
| | | | B grade μ MAX | 2 | 7 | |
| | | T _A = -40°C to +125°C | A grade SO | 1 | 5 | |
| | | | B grade SO | 2 | 10 | |
| | | | A grade μ MAX | 2 | 5 | |
| | | | B grade μ MAX | 3 | 12 | |
| Line Regulation | $\Delta V_{OUT}/\Delta V_{IN}$ | 2.7V \leq V _{IN} \leq 12.6V | T _A = +25°C | 2 | 20 | μ V/V |
| | | | T _A = -40°C to +125°C | | 40 | |
| Load Regulation | $\Delta V_{OUT}/\Delta I_{OUT}$ | Sourcing: 0 \leq I _{OUT} \leq 10mA | | 0.7 | 25 | μ V/mA |
| | | Sinking: -10mA \leq I _{OUT} \leq 0 | | 1.3 | 25 | |
| OUT Short-Circuit Current | I _{SC} | Short to GND | | 160 | | mA |
| | | Short to IN | | 20 | | |
| Thermal Hysteresis (Note 2) | $\Delta V_{OUT}/$ cycle | SO | | 25 | | ppm |
| | | μ MAX | | 80 | | |
| Long-Term Stability | $\Delta V_{OUT}/$ time | 1000hr at T _A = +25°C | SO | 20 | | ppm/ 1000hr |
| | | | μ MAX | 100 | | |

MAX6126

Ultra-High-Precision, Ultra-Low-Noise, Series Voltage Reference

ELECTRICAL CHARACTERISTICS—MAX6126_21 (V_{OUT} = 2.048V) (continued)

(V_{IN} = 5V, C_{LOAD} = 0.1μF, I_{OUT} = 0, T_A = T_{MIN} to T_{MAX}, unless otherwise noted. Typical values are at T_A = +25°C.)

| PARAMETER | SYMBOL | CONDITIONS | | MIN | TYP | MAX | UNITS |
|---------------------------------|-------------------|--|-------------------------|-----|-----------|------|-------------------|
| DYNAMIC CHARACTERISTICS | | | | | | | |
| Noise Voltage | e _{OUT} | f = 0.1Hz to 10Hz | | | 1.3 | | μV _{P-P} |
| | | f = 1kHz, C _{NR} = 0 | | | 60 | | nV/√Hz |
| | | f = 1kHz, C _{NR} = 0.1μF | | | 35 | | |
| Turn-On Settling Time | t _R | To V _{OUT} = 0.01% of final value | C _{NR} = 0 | | 0.8 | | ms |
| | | | C _{NR} = 0.1μF | | 20 | | |
| Capacitive-Load Stability Range | C _{LOAD} | No sustained oscillations | | | 0.1 to 10 | | μF |
| INPUT | | | | | | | |
| Supply Voltage Range | V _{IN} | Guaranteed by line-regulation test | | 2.7 | | 12.6 | V |
| Quiescent Supply Current | I _{IN} | T _A = +25°C | | | 380 | 550 | μA |
| | | T _A = -40°C to +125°C | | | | 725 | |

ELECTRICAL CHARACTERISTICS—MAX6126_25 (V_{OUT} = 2.500V)

(V_{IN} = 5V, C_{LOAD} = 0.1μF, I_{OUT} = 0, T_A = T_{MIN} to T_{MAX}, unless otherwise noted. Typical values are at T_A = +25°C.)

| PARAMETER | SYMBOL | CONDITIONS | | MIN | TYP | MAX | UNITS |
|---|--------------------------------------|--|----------------------------------|-------|-------|-------|--------|
| OUTPUT | | | | | | | |
| Output Voltage | V _{OUT} | T _A = +25°C | | | 2.500 | | V |
| Output Voltage Accuracy | | Referred to V _{OUT} , T _A = +25°C | A grade SO | -0.02 | | +0.02 | % |
| | | | B grade SO | -0.06 | | +0.06 | |
| | | | A grade μMAX | -0.06 | | +0.06 | |
| | | | B grade μMAX | -0.1 | | +0.1 | |
| Output Voltage Temperature Coefficient (Note 1) | TCV _{OUT} | T _A = -40°C to +85°C | A grade SO | | 0.5 | 3 | ppm/°C |
| | | | B grade SO | | 1 | 5 | |
| | | | A grade μMAX | | 1 | 3 | |
| | | | B grade μMAX | | 2 | 7 | |
| | | T _A = -40°C to +125°C | A grade SO | | 1 | 5 | |
| | | | B grade SO | | 2 | 10 | |
| | | | A grade μMAX | | 2 | 5 | |
| | | | B grade μMAX | | 3 | 12 | |
| Line Regulation | ΔV _{OUT} /ΔV _{IN} | 2.7V ≤ V _{IN} ≤ 12.6V | T _A = +25°C | | 3 | 20 | μV/V |
| | | | T _A = -40°C to +125°C | | | 40 | |
| Load Regulation | ΔV _{OUT} /ΔI _{OUT} | Sourcing: 0 ≤ I _{OUT} ≤ 10mA | | | 1 | 25 | μV/mA |
| | | Sinking: -10mA ≤ I _{OUT} ≤ 0 | | | 1.8 | 25 | |

MAX6126

Ultra-High-Precision, Ultra-Low-Noise, Series Voltage Reference

ELECTRICAL CHARACTERISTICS—MAX6126_25 (V_{OUT} = 2.500V) (continued)

(V_{IN} = 5V, C_{LOAD} = 0.1μF, I_{OUT} = 0, T_A = T_{MIN} to T_{MAX}, unless otherwise noted. Typical values are at T_A = +25°C.)

| PARAMETER | SYMBOL | CONDITIONS | | MIN | TYP | MAX | UNITS |
|---------------------------------|------------------------------------|--|-------------------------|-----------|------|-------------------|-------|
| Dropout Voltage (Note 3) | V _{IN} - V _{OUT} | ΔV _{OUT} = 0.1% | I _{OUT} = 5mA | 0.06 | 0.2 | V | |
| | | | I _{OUT} = 10mA | 0.12 | 0.4 | | |
| OUT Short-Circuit Current | I _{SC} | Short to GND | | 160 | | mA | |
| | | Short to IN | | 20 | | | |
| Thermal Hysteresis (Note 2) | ΔV _{OUT} /cycle | SO | | 35 | | ppm | |
| | | μMAX | | 80 | | | |
| Long-Term Stability | ΔV _{OUT} /time | 1000hr at T _A = +25°C | SO | 20 | | ppm/1000hr | |
| | | | μMAX | 100 | | | |
| DYNAMIC CHARACTERISTICS | | | | | | | |
| Noise Voltage | e _{OUT} | f = 0.1Hz to 10Hz | | 1.45 | | μV _{P-P} | |
| | | f = 1kHz, C _{NR} = 0 | | 75 | | | |
| | | f = 1kHz, C _{NR} = 0.1μF | | 45 | | | |
| Turn-On Settling Time | t _R | To V _{OUT} = 0.01% of final value | C _{NR} = 0 | 1 | | ms | |
| | | | C _{NR} = 0.1μF | 20 | | | |
| Capacitive-Load Stability Range | C _{LOAD} | No sustained oscillations | | 0.1 to 10 | | μF | |
| INPUT | | | | | | | |
| Supply Voltage Range | V _{IN} | Guaranteed by line-regulation test | | 2.7 | 12.6 | V | |
| Quiescent Supply Current | I _{IN} | T _A = +25°C | | 380 | 550 | μA | |
| | | T _A = -40°C to +125°C | | 725 | | | |

ELECTRICAL CHARACTERISTICS—MAX6126_28 (V_{OUT} = 2.800V)

(V_{IN} = 5V, C_{LOAD} = 0.1μF, I_{OUT} = 0, T_A = T_{MIN} to T_{MAX}, unless otherwise noted. Typical values are at T_A = +25°C.)

| PARAMETER | SYMBOL | CONDITIONS | | MIN | TYP | MAX | UNITS |
|---|-------------------------------------|---|----------------------------------|-------|-------|--------|-------|
| OUTPUT | | | | | | | |
| Output Voltage | V _{OUT} | T _A = +25°C | | 2.800 | | V | |
| Output Voltage Accuracy | | Referred to V _{OUT} , T _A = +25°C | A grade μMAX | -0.06 | +0.06 | % | |
| | | | B grade μMAX | -0.10 | +0.10 | | |
| Output Voltage Temperature Coefficient (Note 1) | TCV _{OUT} | T _A = -40°C to +85°C | A grade μMAX | 1 | 3 | ppm/°C | |
| | | | B grade μMAX | 2 | 7 | | |
| | | T _A = -40°C to +125°C | A grade μMAX | 2 | 5 | | |
| | | | B grade μMAX | 3 | 12 | | |
| Line Regulation | ΔV _{OUT} /ΔV _{IN} | 3.0V ≤ V _{IN} ≤ 12.6V | T _A = +25°C | 3.5 | 23 | μV/V | |
| | | | T _A = -40°C to +125°C | 45 | | | |
| Load Regulation | ΔV _{OUT} /ΔV _{IN} | Sourcing: 0 ≤ I _{OUT} ≤ 10mA | | 1.3 | 28 | μV/mA | |
| | | Sinking: -10mA ≤ I _{OUT} ≤ 0 | | 2.4 | 28 | | |
| Dropout Voltage (Note 3) | V _{IN} - V _{OUT} | ΔV _{OUT} = 0.1% | I _{OUT} = 5mA | 0.06 | 0.2 | V | |
| | | | I _{OUT} = 10mA | 0.12 | 0.4 | | |

MAX6126

Ultra-High-Precision, Ultra-Low-Noise, Series Voltage Reference

ELECTRICAL CHARACTERISTICS—MAX6126_28 (V_{OUT} = 2.800V) (continued)

(V_{IN} = 5V, C_{LOAD} = 0.1μF, I_{OUT} = 0, T_A = T_{MIN} to T_{MAX}, unless otherwise noted. Typical values are at T_A = +25°C.)

| PARAMETER | SYMBOL | CONDITIONS | | MIN | TYP | MAX | UNITS |
|---------------------------------|--------------------------|--|-------------------------|-----|-----------|------|-------------------|
| OUT Short-Circuit Current | I _{SC} | Short to GND | | | 160 | | mA |
| | | Short to IN | | | 20 | | |
| Thermal Hysteresis (Note 2) | ΔV _{OUT} /cycle | μMAX | | | 80 | | ppm |
| Long-Term Stability | ΔV _{OUT} /time | 1000hr at T _A = +25°C | μMAX | | 100 | | ppm/ 1000hr |
| DYNAMIC CHARACTERISTICS | | | | | | | |
| Noise Voltage | e _{OUT} | f = 0.1Hz to 10Hz | | | 1.45 | | μV _{P-P} |
| | | f = 1kHz, C _{NR} = 0 | | | 75 | | nV/√Hz |
| | | f = 1kHz, C _{NR} = 0.1μF | | | 45 | | |
| Turn-On Settling Time | t _R | To V _{OUT} = 0.01% of final value | C _{NR} = 0 | | 1 | | ms |
| | | | C _{NR} = 0.1μF | | 20 | | |
| Capacitive-Load Stability Range | C _{LOAD} | No sustained oscillations | | | 0.1 to 10 | | μF |
| INPUT | | | | | | | |
| Supply Voltage Range | V _{IN} | Guaranteed by line-regulation test | | 3.0 | | 12.6 | V |
| Quiescent Supply Current | I _{IN} | T _A = +25°C | | | 380 | 550 | μA |
| | | T _A = -40°C to +125°C | | | | 725 | |

ELECTRICAL CHARACTERISTICS—MAX6126_30 (V_{OUT} = 3.000V)

(V_{IN} = 5V, C_{LOAD} = 0.1μF, I_{OUT} = 0, T_A = T_{MIN} to T_{MAX}, unless otherwise noted. Typical values are at T_A = +25°C.)

| PARAMETER | SYMBOL | CONDITIONS | | MIN | TYP | MAX | UNITS |
|---|--------------------|--|--------------|-------|-------|-------|--------|
| OUTPUT | | | | | | | |
| Output Voltage | V _{OUT} | T _A = +25°C | | | 3.000 | | V |
| Output Voltage Accuracy | | Referred to V _{OUT} , T _A = +25°C | A grade SO | -0.02 | | +0.02 | % |
| | | | B grade SO | -0.06 | | +0.06 | |
| | | | A grade μMAX | -0.06 | | +0.06 | |
| | | | B grade μMAX | -0.1 | | +0.1 | |
| Output Voltage Temperature Coefficient (Note 1) | TCV _{OUT} | T _A = -40°C to +85°C | A grade SO | | 0.5 | 3 | ppm/°C |
| | | | B grade SO | | 1 | 5 | |
| | | | A grade μMAX | | 1 | 3 | |
| | | | B grade μMAX | | 2 | 7 | |
| | | T _A = -40°C to +125°C | A grade SO | | 1 | 5 | |
| | | | B grade SO | | 2 | 10 | |
| | | | A grade μMAX | | 2 | 5 | |
| | | | B grade μMAX | | 3 | 12 | |

MAX6126

Ultra-High-Precision, Ultra-Low-Noise, Series Voltage Reference

ELECTRICAL CHARACTERISTICS—MAX6126_30 (V_{OUT} = 3.000V) (continued)

(V_{IN} = 5V, C_{LOAD} = 0.1μF, I_{OUT} = 0, T_A = T_{MIN} to T_{MAX}, unless otherwise noted. Typical values are at T_A = +25°C.)

| PARAMETER | SYMBOL | CONDITIONS | | MIN | TYP | MAX | UNITS |
|---------------------------------|------------------------------------|--|----------------------------------|-----|-----------|------|-------------------|
| Line Regulation | $\Delta V_{OUT}/\Delta V_{IN}$ | 3.2V ≤ V _{IN} ≤ 12.6V | T _A = +25°C | | 4 | 25 | μV/V |
| | | | T _A = -40°C to +125°C | | | 50 | |
| Load Regulation | $\Delta V_{OUT}/\Delta I_{OUT}$ | Sourcing: 0 ≤ I _{OUT} ≤ 10mA | | | 1.5 | 30 | μV/mA |
| | | Sinking: -10mA ≤ I _{OUT} ≤ 0 | | | 2.8 | 30 | |
| Dropout Voltage (Note 3) | V _{IN} - V _{OUT} | ΔV _{OUT} = 0.1% | I _{OUT} = 5mA | | 0.06 | 0.2 | V |
| | | | I _{OUT} = 10mA | | 0.11 | 0.4 | |
| OUT Short-Circuit Current | I _{SC} | Short to GND | | | 160 | | mA |
| | | Short to IN | | | 20 | | |
| Thermal Hysteresis (Note 2) | $\Delta V_{OUT}/\text{cycle}$ | SO | | | 20 | | ppm |
| | | μMAX | | | 80 | | |
| Long-Term Stability | $\Delta V_{OUT}/\text{time}$ | 1000hr at T _A = +25°C | SO | | 20 | | ppm/1000hr |
| | | | μMAX | | 100 | | |
| DYNAMIC CHARACTERISTICS | | | | | | | |
| Noise Voltage | e _{OUT} | f = 0.1Hz to 10Hz | | | 1.75 | | μV _{P-P} |
| | | f = 1kHz, C _{NR} = 0 | | | 90 | | nV/√Hz |
| | | f = 1kHz, C _{NR} = 0.1μF | | | 55 | | |
| Capacitive-Load Stability Range | C _{LOAD} | No sustained oscillations | | | 0.1 to 10 | | μF |
| Turn-On Settling Time | t _R | To V _{OUT} = 0.01% of final value | C _{NR} = 0 | | 1.2 | | ms |
| | | | C _{NR} = 0.1μF | | 20 | | |
| INPUT | | | | | | | |
| Supply Voltage Range | V _{IN} | Guaranteed by line-regulation test | | 3.2 | | 12.6 | V |
| Quiescent Supply Current | I _{IN} | T _A = +25°C | | | 380 | 550 | μA |
| | | T _A = -40°C to +125°C | | | | 725 | |

ELECTRICAL CHARACTERISTICS—MAX6126_41 (V_{OUT} = 4.096V)

(V_{IN} = 5V, C_{LOAD} = 0.1μF, I_{OUT} = 0, T_A = T_{MIN} to T_{MAX}, unless otherwise noted. Typical values are at T_A = +25°C.)

| PARAMETER | SYMBOL | CONDITIONS | | MIN | TYP | MAX | UNITS |
|-------------------------|------------------|--|--------------|-----|-------|-------|-------|
| OUTPUT | | | | | | | |
| Output Voltage | V _{OUT} | T _A = +25°C | | | 4.096 | | V |
| Output Voltage Accuracy | | Referred to V _{OUT} , T _A = +25°C | A grade SO | | -0.02 | +0.02 | % |
| | | | B grade SO | | -0.06 | +0.06 | |
| | | | A grade μMAX | | -0.06 | +0.06 | |
| | | | B grade μMAX | | -0.1 | +0.1 | |

MAX6126

Ultra-High-Precision, Ultra-Low-Noise, Series Voltage Reference

ELECTRICAL CHARACTERISTICS—MAX6126_41 (V_{OUT} = 4.096V) (continued)

(V_{IN} = 5V, C_{LOAD} = 0.1μF, I_{OUT} = 0, T_A = T_{MIN} to T_{MAX}, unless otherwise noted. Typical values are at T_A = +25°C.)

| PARAMETER | SYMBOL | CONDITIONS | | MIN | TYP | MAX | UNITS |
|---|--------------------------------------|--|----------------------------------|-----|-----------|------|-------------------|
| Output Voltage Temperature Coefficient (Note 1) | TCV _{OUT} | T _A = -40°C to +85°C | A grade SO | | 0.5 | 3 | ppm/°C |
| | | | B grade SO | | 1 | 5 | |
| | | | A grade μMAX | | 1 | 3 | |
| | | | B grade μMAX | | 2 | 7 | |
| | | T _A = -40°C to +125°C | A grade SO | | 1 | 5 | |
| | | | B grade SO | | 2 | 10 | |
| | | | A grade μMAX | | 2 | 5 | |
| | | | B grade μMAX | | 3 | 12 | |
| Line Regulation | ΔV _{OUT} /ΔV _{IN} | 4.3V ≤ V _{IN} ≤ 12.6V | T _A = +25°C | | 4.5 | 30 | μV/V |
| | | | T _A = -40°C to +125°C | | | 60 | |
| Load Regulation | ΔV _{OUT} /ΔI _{OUT} | Sourcing: 0 ≤ I _{OUT} ≤ 10mA | | | 2 | 40 | μV/mA |
| | | Sinking: -10mA ≤ I _{OUT} ≤ 0 | | | 5 | 40 | |
| Dropout Voltage (Note 3) | V _{IN} - V _{OUT} | ΔV _{OUT} = 0.1% | I _{OUT} = 5mA | | 0.05 | 0.2 | V |
| | | | I _{OUT} = 10mA | | 0.1 | 0.4 | |
| OUT Short-Circuit Current | I _{SC} | Short to GND | | | 160 | | mA |
| | | Short to IN | | | 20 | | |
| Thermal Hysteresis (Note 2) | ΔV _{OUT} /cycle | SO | | | 20 | | ppm |
| | | μMAX | | | 80 | | |
| Long-Term Stability | ΔV _{OUT} /time | 1000hr at T _A = +25°C | SO | | 20 | | ppm/1000hr |
| | | | μMAX | | 100 | | |
| DYNAMIC CHARACTERISTICS | | | | | | | |
| Noise Voltage | e _{OUT} | f = 0.1Hz to 10Hz | | | 2.4 | | μV _{P-P} |
| | | f = 1kHz, C _{NR} = 0 | | | 120 | | nV/√Hz |
| | | f = 1kHz, C _{NR} = 0.1μF | | | 80 | | |
| Capacitive-Load Stability Range | C _{LOAD} | No sustained oscillations | | | 0.1 to 10 | | μF |
| Turn-On Settling Time | t _R | To V _{OUT} = 0.01% of final value | C _{NR} = 0 | | 1.6 | | ms |
| | | | C _{NR} = 0.1μF | | 20 | | |
| INPUT | | | | | | | |
| Supply Voltage Range | V _{IN} | Guaranteed by line-regulation test | | | 4.3 | 12.6 | V |
| Quiescent Supply Current | I _{IN} | T _A = +25°C | | | 380 | 550 | μA |
| | | T _A = -40°C to +125°C | | | | 725 | |

MAX6126

Ultra-High-Precision, Ultra-Low-Noise, Series Voltage Reference

ELECTRICAL CHARACTERISTICS—MAX6126_50 (V_{OUT} = 5.000V)

(V_{IN} = 5.5V, C_{LOAD} = 0.1μF, I_{OUT} = 0, T_A = T_{MIN} to T_{MAX}, unless otherwise noted. Typical values are at T_A = +25°C.)

| PARAMETER | SYMBOL | CONDITIONS | | MIN | TYP | MAX | UNITS |
|---|--------------------------------------|---------------------------------------|----------------------------------|-------|-----------|-------|-------------------|
| OUTPUT | | | | | | | |
| Output Voltage | V _{OUT} | T _A = +25°C | | 5.000 | | | V |
| Output Voltage Accuracy | | T _A = +25°C | A grade SO | -0.02 | | +0.02 | % |
| | | | B grade SO | -0.06 | | +0.06 | |
| | | | A grade μMAX | -0.06 | | +0.06 | |
| | | | B grade μMAX | -0.1 | | +0.1 | |
| Output Voltage Temperature Coefficient (Note 1) | TCV _{OUT} | T _A = -40°C to +85°C | A grade SO | | 0.5 | 3 | ppm/°C |
| | | | B grade SO | | 1 | 5 | |
| | | | A grade μMAX | | 1 | 3 | |
| | | | B grade μMAX | | 2 | 7 | |
| | | T _A = -40°C to +125°C | A grade SO | | 1 | 5 | |
| | | | B grade SO | | 2 | 10 | |
| | | | A grade μMAX | | 2 | 5 | |
| | | | B grade μMAX | | 3 | 12 | |
| Line Regulation | ΔV _{OUT} /ΔV _{IN} | 5.2V ≤ V _{IN} ≤ 12.6V | T _A = +25°C | | 3 | 40 | μV/V |
| | | | T _A = -40°C to +125°C | | | 80 | |
| Load Regulation | ΔV _{OUT} /ΔI _{OUT} | Sourcing: 0 ≤ I _{OUT} ≤ 10mA | | | 2.5 | 50 | μV/mA |
| | | Sinking: -10mA ≤ I _{OUT} ≤ 0 | | | 6.5 | 50 | |
| Dropout Voltage (Note 3) | V _{IN} - V _{OUT} | ΔV _{OUT} = 0.1% | I _{OUT} = 5mA | | 0.05 | 0.2 | V |
| | | | I _{OUT} = 10mA | | 0.1 | 0.4 | |
| OUT Short-Circuit Current | I _{SC} | Short to GND | | | 160 | | mA |
| | | Short to IN | | | 20 | | |
| Thermal Hysteresis (Note 2) | ΔV _{OUT} /cycle | SO | | | 15 | | ppm |
| | | μMAX | | | 80 | | |
| Long-Term Stability | ΔV _{OUT} /time | 1000hr at T _A = +25°C | SO | | 20 | | ppm/1000hr |
| | | | μMAX | | 100 | | |
| DYNAMIC CHARACTERISTICS | | | | | | | |
| Noise Voltage | e _{OUT} | f = 0.1Hz to 10Hz | | | 2.85 | | μV _{P-P} |
| | | f = 1kHz, C _{NR} = 0 | | | 145 | | nV/√Hz |
| | | f = 1kHz, C _{NR} = 0.1μF | | | 95 | | |
| Capacitive-Load Stability Range | C _{LOAD} | No sustained oscillations | | | 0.1 to 10 | | μF |

MAX6126

Ultra-High-Precision, Ultra-Low-Noise, Series Voltage Reference

ELECTRICAL CHARACTERISTICS—MAX6126_50 (V_{OUT} = 5.000V) (continued)

(V_{IN} = 5.5V, C_{LOAD} = 0.1μF, I_{OUT} = 0, T_A = T_{MIN} to T_{MAX}, unless otherwise noted. Typical values are at T_A = +25°C.)

| PARAMETER | SYMBOL | CONDITIONS | MIN | TYP | MAX | UNITS |
|--------------------------|-----------------|--|-------------|-----|------|-------|
| Turn-On Settling Time | t _R | To V _{OUT} = 0.01% of final value | CNR = 0 | | 2 | ms |
| | | | CNR = 0.1μF | | 20 | |
| INPUT | | | | | | |
| Supply Voltage Range | V _{IN} | Guaranteed by line-regulation test | 5.2 | | 12.6 | V |
| Quiescent Supply Current | I _{IN} | T _A = +25°C | | 380 | 550 | μA |
| | | T _A = -40°C to +125°C | | | 725 | |

- Note 1:** Temperature coefficient is measured by the “box” method, i.e., the maximum ΔV_{OUT} / V_{OUT} is divided by the maximum ΔT.
- Note 2:** Thermal hysteresis is defined as the change in +25°C output voltage before and after cycling the device from T_{MAX} to T_{MIN}.
- Note 3:** Dropout voltage is defined as the minimum differential voltage (V_{IN} - V_{OUT}) at which V_{OUT} decreases by 0.1% from its original value at V_{IN} = 5.0V (V_{IN} = 5.5V for V_{OUT} = 5.0V).

Typical Operating Characteristics

(V_{IN} = 5V for MAX6126_21/25/30/41, V_{IN} = 5.5V for MAX6126_50, C_{LOAD} = 0.1μF, I_{OUT} = 0, T_A = +25°C, unless otherwise specified.) (Note 5)

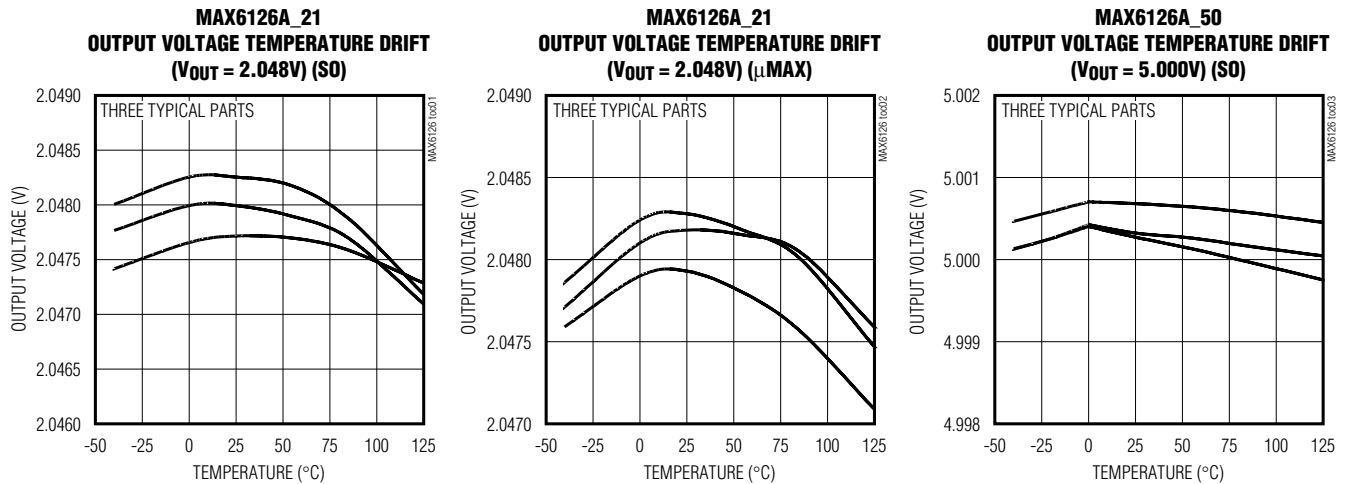

MAX6126

Ultra-High-Precision, Ultra-Low-Noise, Series Voltage Reference

Typical Operating Characteristics (continued)

($V_{IN} = 5V$ for MAX6126_21/25/30/41, $V_{IN} = 5.5V$ for MAX6126_50, $C_{LOAD} = 0.1\mu F$, $I_{OUT} = 0$, $T_A = +25^\circ C$, unless otherwise specified.)
(Note 5)

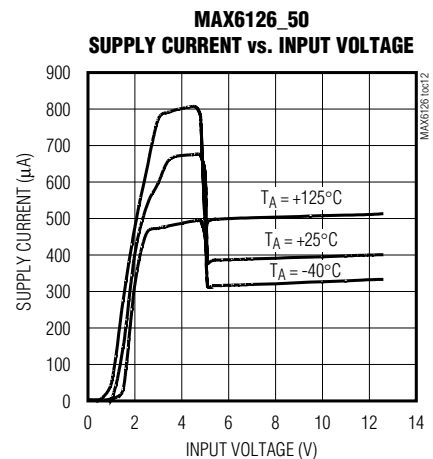
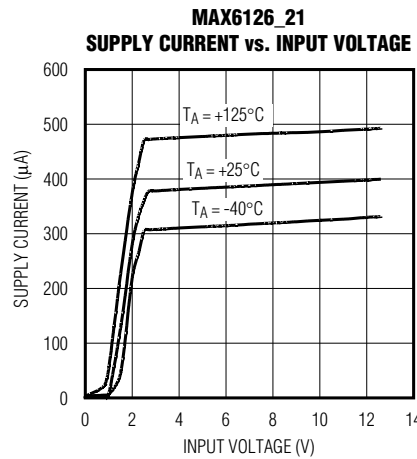
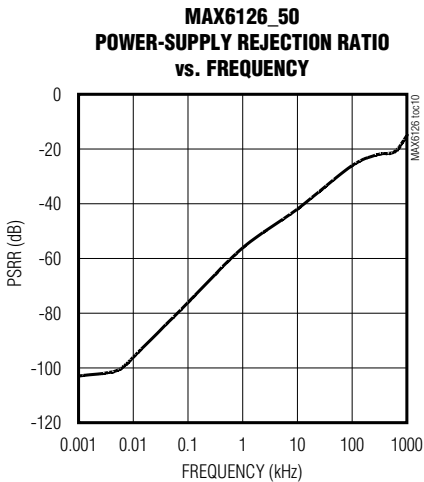
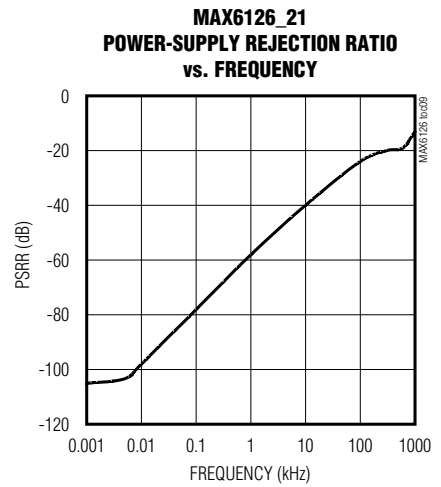
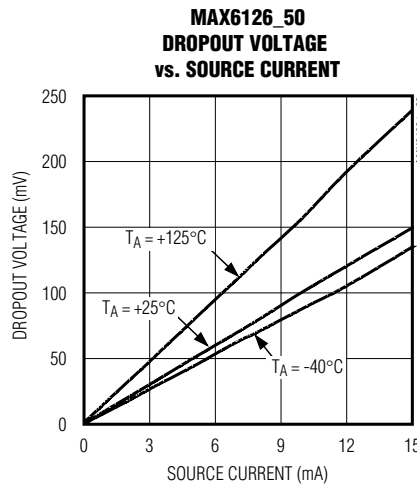
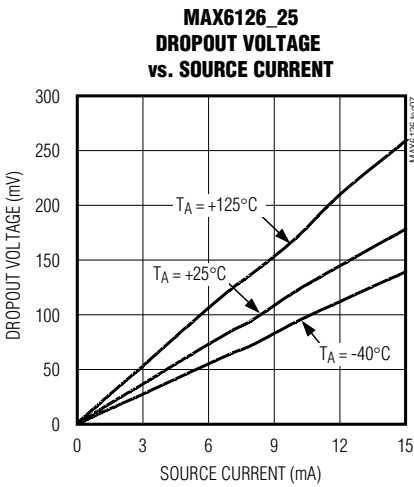
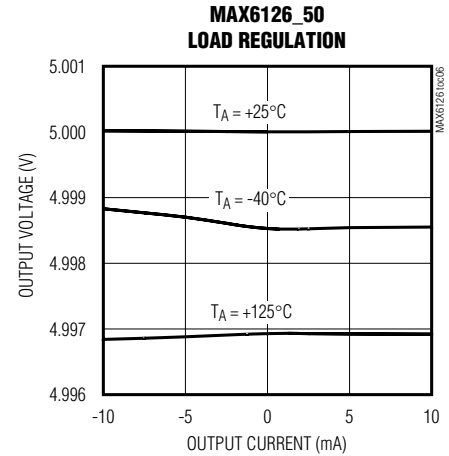
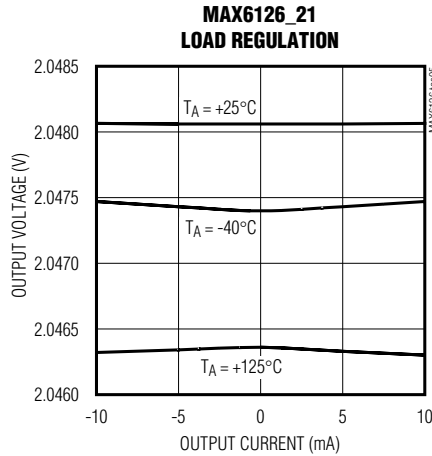
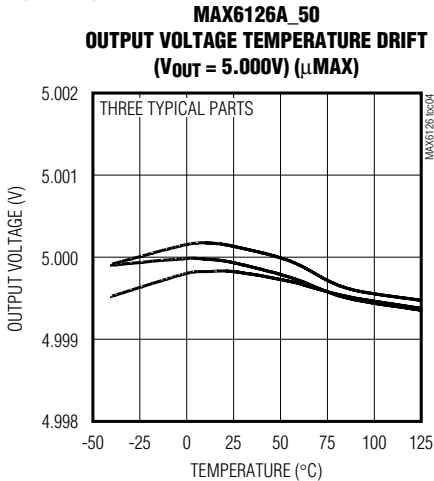

MAX6126

Ultra-High-Precision, Ultra-Low-Noise, Series Voltage Reference

Typical Operating Characteristics (continued)

($V_{IN} = 5V$ for MAX6126_21/25/30/41, $V_{IN} = 5.5V$ for MAX6126_50, $C_{LOAD} = 0.1\mu F$, $I_{OUT} = 0$, $T_A = +25^\circ C$, unless otherwise specified.)
(Note 5)

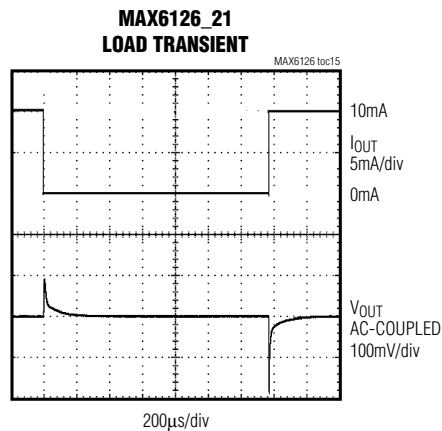
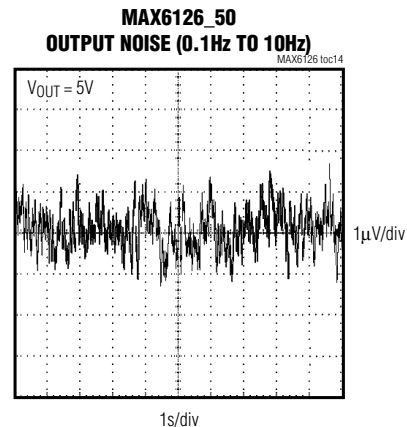
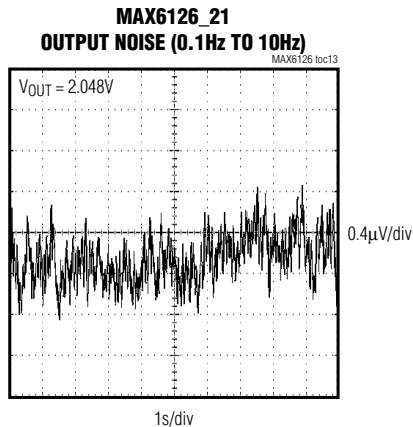

$C_{LOAD} = 0.1\mu F$ $I_{OUT} = 0$ TO 10mA
 $V_{IN} = 5V$ $V_{OUT} = 2.048V$

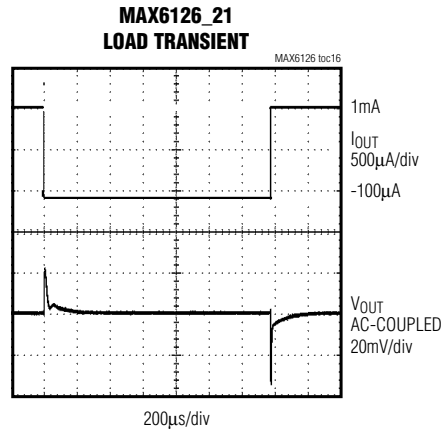

$C_{LOAD} = 0.1\mu F$ $I_{OUT} = -100\mu A$ TO 1mA
 $V_{IN} = 5V$ $V_{OUT} = 2.048V$

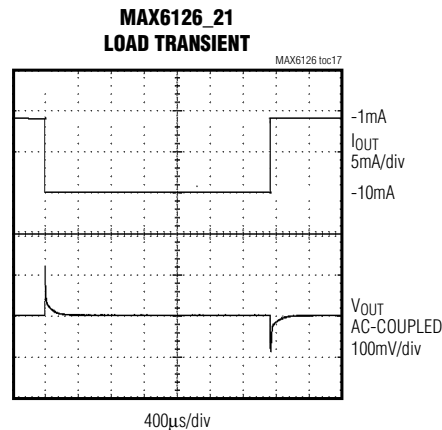

$C_{LOAD} = 0.1\mu F$ $I_{OUT} = -1mA$ TO -10mA
 $V_{IN} = 5V$ $V_{OUT} = 2.048V$

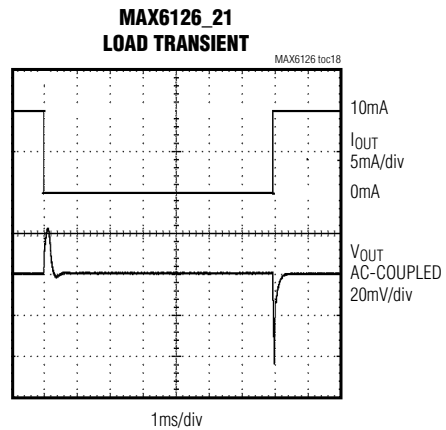

$C_{LOAD} = 10\mu F$ $I_{OUT} = 0$ TO 10mA
 $V_{IN} = 5V$ $V_{OUT} = 2.048V$

MAX6126

Ultra-High-Precision, Ultra-Low-Noise, Series Voltage Reference

Typical Operating Characteristics (continued)

($V_{IN} = 5V$ for MAX6126_21/25/30/41, $V_{IN} = 5.5V$ for MAX6126_50, $C_{LOAD} = 0.1\mu F$, $I_{OUT} = 0$, $T_A = +25^\circ C$, unless otherwise specified.)
(Note 5)

**MAX6126_21
LOAD TRANSIENT**

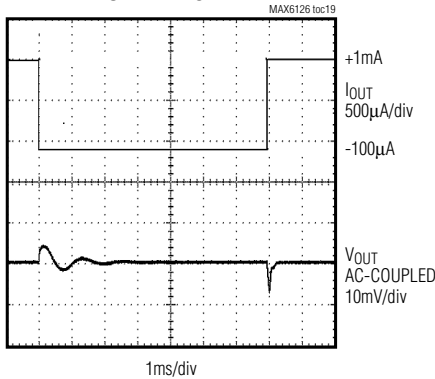

$C_{LOAD} = 10\mu F$ $I_{OUT} = -100\mu A$ TO 1mA
 $V_{IN} = 5V$ $V_{OUT} = 2.048V$

**MAX6126_21
LOAD TRANSIENT**

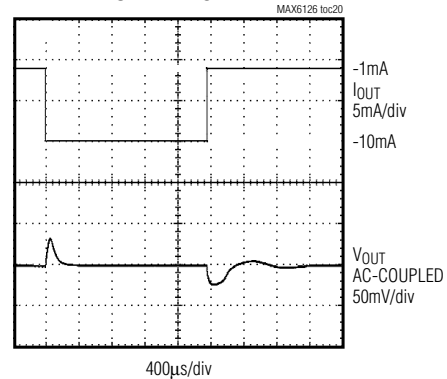

$C_{LOAD} = 10\mu F$ $I_{OUT} = -1mA$ TO -10mA
 $V_{IN} = 5V$ $V_{OUT} = 2.048V$

**MAX6126_21
LINE TRANSIENT**

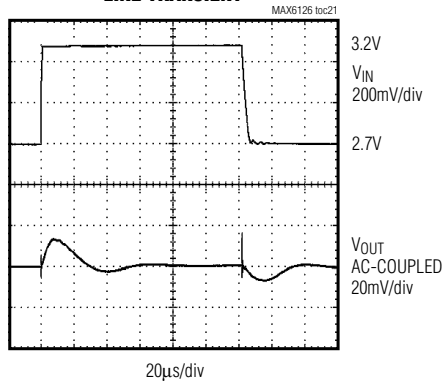

$V_{OUT} = 2.048V$ $C_{LOAD} = 0.1\mu F$

**MAX6126_50
LINE TRANSIENT**

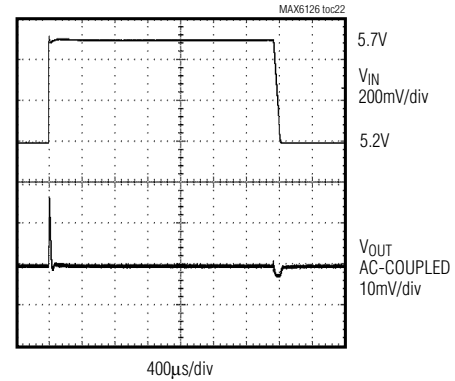

$V_{IN} = 5.2V$ TO 5.7V $C_{LOAD} = 0.1\mu F$
 $V_{OUT} = 5V$

**MAX6126_21
TURN-ON TRANSIENT**

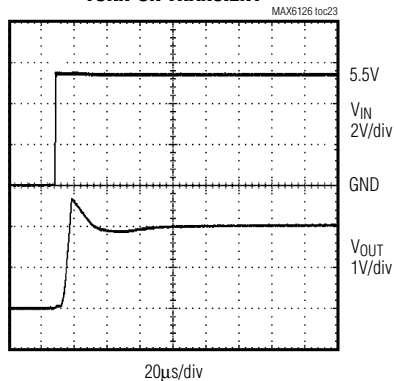

$C_{LOAD} = 0.1\mu F$
 $V_{OUT} = 2.048V$

**MAX6126_50
TURN-ON TRANSIENT**

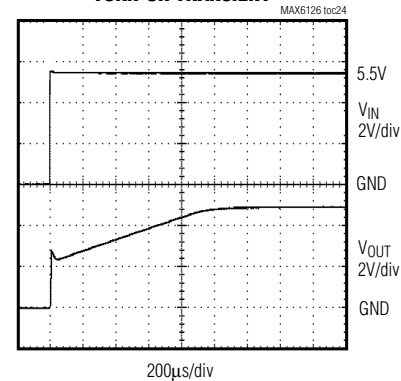

$C_{LOAD} = 0.1\mu F$
 $V_{OUT} = 5V$

MAX6126

Ultra-High-Precision, Ultra-Low-Noise, Series Voltage Reference

Typical Operating Characteristics (continued)

($V_{IN} = 5V$ for MAX6126_21/25/30/41, $V_{IN} = 5.5V$ for MAX6126_50, $C_{LOAD} = 0.1\mu F$, $I_{OUT} = 0$, $T_A = +25^\circ C$, unless otherwise specified.)
(Note 5)

**MAX6126_21
TURN-ON TRANSIENT**

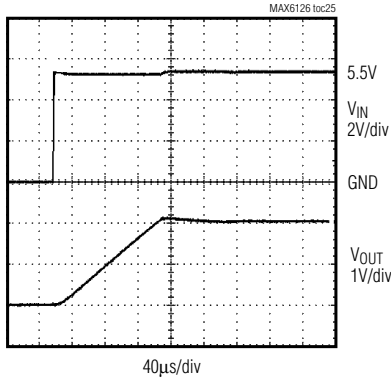

$C_{LOAD} = 10\mu F$
 $V_{OUT} = 2.048V$

**MAX6126_50
TURN-ON TRANSIENT**

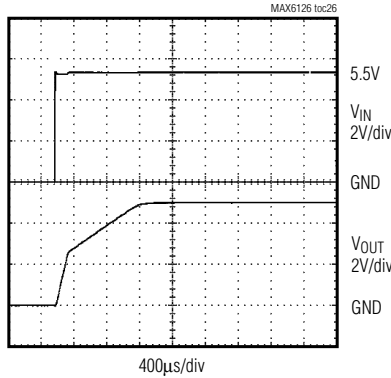

$C_{LOAD} = 10\mu F$
 $V_{OUT} = 5V$

**MAX6126B_25
LONG-TERM STABILITY vs. TIME (S0)**

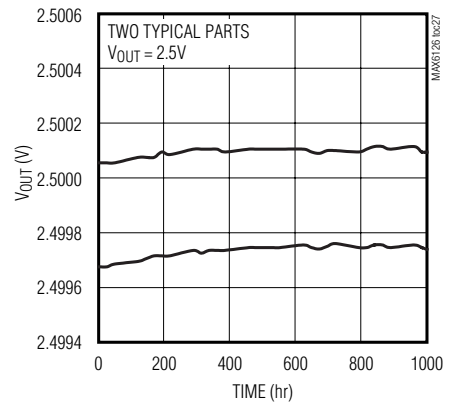

**MAX6126B_25
LONG-TERM STABILITY vs. TIME (μ MAX)**

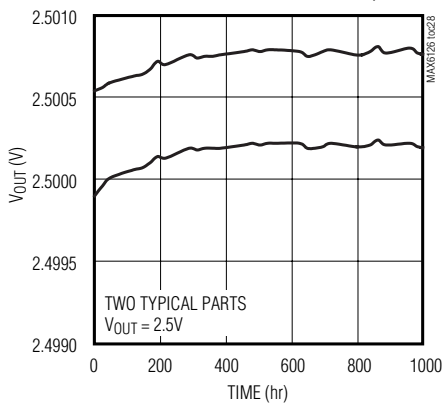

**MAX6126B_50
LONG-TERM STABILITY vs. TIME (S0)**

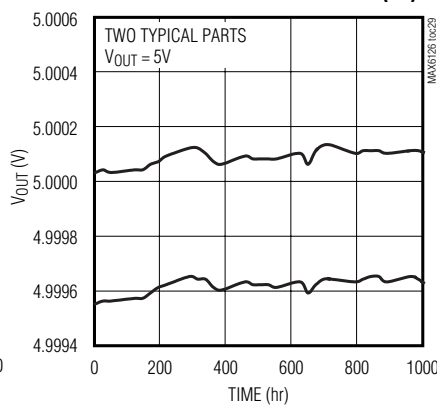

**MAX6126B_50
LONG-TERM STABILITY vs. TIME (μ MAX)**

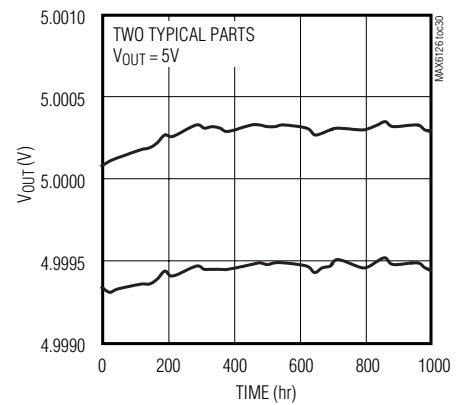

Note 5: Many of the MAX6126 *Typical Operating Characteristics* are extremely similar. The extremes of these characteristics are found in the MAX6126_21 (2.048V output) and the MAX6126_50 (5.000V output). The *Typical Operating Characteristics* of the remainder of the MAX6126 family typically lie between those two extremes and can be estimated based on their output voltages.

MAX6126

Ultra-High-Precision, Ultra-Low-Noise, Series Voltage Reference

Pin Description

| PIN | NAME | FUNCTION |
|------|------|---|
| 1 | NR | Noise Reduction. Connect a 0.1 μ F capacitor to improve wideband noise. Leave unconnected if not used (see Figure 1). |
| 2 | IN | Positive Power-Supply Input |
| 3 | GND | Ground |
| 4 | GNDS | Ground-Sense Connection. Connect to ground connection at load. |
| 5, 8 | I.C. | Internally Connected. Do not connect anything to these pins. |
| 6 | OUTS | Voltage Reference Sense Output |
| 7 | OUTF | Voltage Reference Force Output. Short OUTF to OUTS as close to the load as possible. Bypass OUTF with a capacitor (0.1 μ F to 10 μ F) to GND. |

Detailed Description

Wideband Noise Reduction

To improve wideband noise and transient power-supply noise, add a 0.1 μ F capacitor to NR (Figure 1). Larger values do not improve noise appreciably. A 0.1 μ F NR capacitor reduces the noise from 60nV/ $\sqrt{\text{Hz}}$ to 35nV/ $\sqrt{\text{Hz}}$ for the 2.048V output. Noise in the power-supply input can affect output noise, but can be reduced by adding an optional bypass capacitor between IN and GND, as shown in the *Typical Operating Circuit*.

Output Bypassing

The MAX6126 requires an output capacitor between 0.1 μ F and 10 μ F. Locate the output capacitor as close to OUTF as possible. For applications driving switching capacitive loads or rapidly changing load currents, it is advantageous to use a 10 μ F capacitor in parallel with a 0.1 μ F capacitor. Larger capacitor values reduce transients on the reference output.

Supply Current

The quiescent supply current of the series-mode MAX6126 family is typically 380 μ A and is virtually independent of the supply voltage, with only a 2 μ A/V (max) variation with supply voltage.

When the supply voltage is below the minimum specified input voltage during turn-on, the device can draw

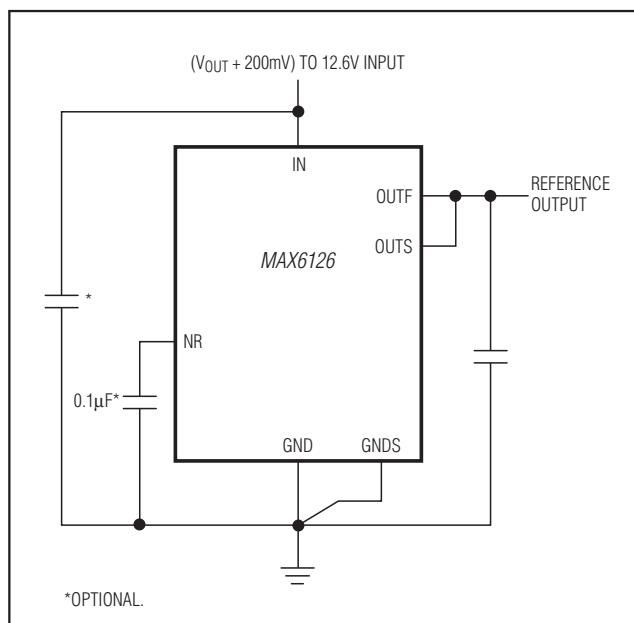

Figure 1. Noise-Reduction Capacitor

up to 300 μ A beyond the nominal supply current. The input voltage source must be capable of providing this current to ensure reliable turn-on.

Thermal Hysteresis

Thermal hysteresis is the change of output voltage at $T_A = +25^\circ\text{C}$ before and after the device is cycled over its entire operating temperature range. The typical thermal hysteresis value is 20ppm (SO package).

Turn-On Time

These devices typically turn on and settle to within 0.1% of their final value in 200 μ s to 2ms depending on the device. The turn-on time can increase up to 4ms with the device operating at the minimum dropout voltage and the maximum load. A noise reduction capacitor of 0.1 μ F increases the turn-on time to 20ms.

Output Force and Sense

The MAX6126 provides independent connections for the power-circuit output (OUTF) supplying current into a load, and for the circuit input regulating the voltage applied to that load (OUTS). This configuration allows for the cancellation of the voltage drop on the lines connecting the MAX6126 and the load. When using the Kelvin connection made possible by the independent current and voltage connections, take the power connection to the load from OUTF, and bring a line from OUTS to join the line from OUTF, at the point where the voltage accu-

Ultra-High-Precision, Ultra-Low-Noise, Series Voltage Reference

racy is needed. The MAX6126 has the same type of Kelvin connection to cancel drops in the ground return line. Connect the load to ground and bring a connection from GNDS to exactly the same point.

Applications Information

Precision Current Source

Figure 2 shows a typical circuit providing a precision current source. The OUTF output provides the bias current for the bipolar transistor. OUTF and OSTS sense the voltage across the resistor and adjust the current sourced by OUTF accordingly. For even higher precision, use a MOSFET to eliminate base current errors.

High-Resolution DAC and Reference from a Single Supply

Figure 3 shows a typical circuit providing the reference for a high-resolution, 16-bit MAX541 D/A converter.

Temperature Coefficient vs. Operating Temperature Range for a 1 LSB Maximum Error

In a data converter application, the reference voltage of the converter must stay within a certain limit to keep the error in the data converter smaller than the resolution limit through the operating temperature range. Figure 4 shows the maximum allowable reference voltage temperature coefficient to keep the conversion error to less than 1 LSB, as a function of the operating temperature range ($T_{MAX} - T_{MIN}$) with the converter resolution as a parameter. The graph assumes the reference voltage temperature coefficient as the only parameter affecting accuracy.

In reality, the absolute static accuracy of a data converter is dependent on the combination of many parameters such as integral nonlinearity, differential nonlinearity, offset error, gain error, as well as voltage reference changes.

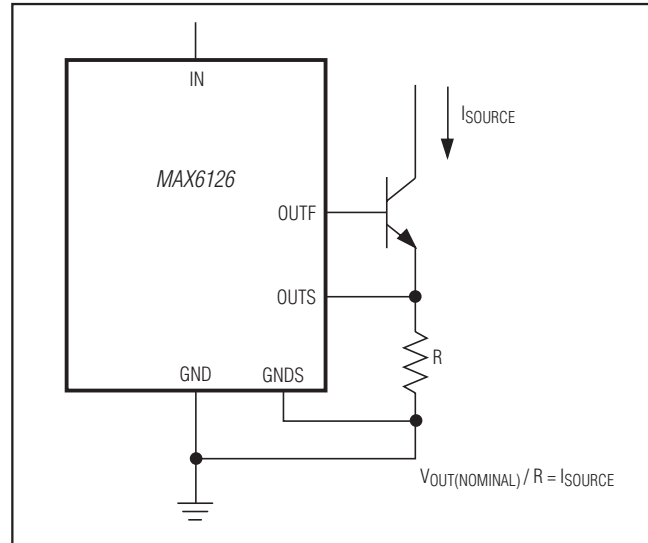

Figure 2. Precision Current Source

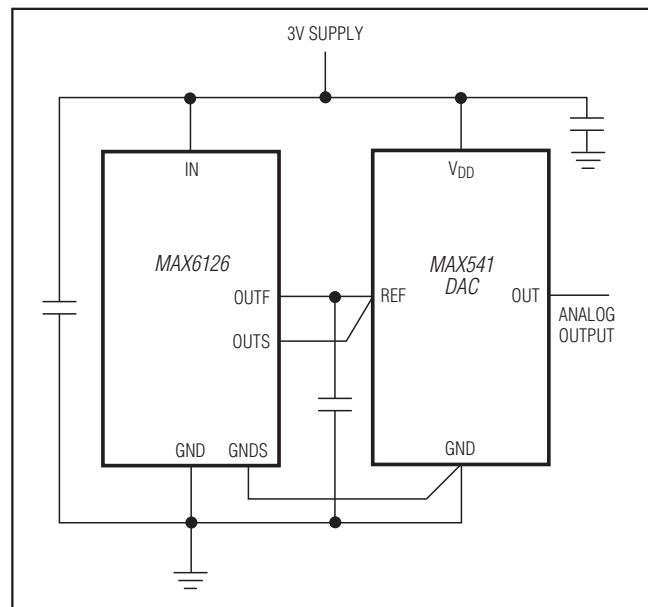

Figure 3. 14-Bit High-Resolution DAC and Positive Reference from a Single 3V Supply

MAX6126

Ultra-High-Precision, Ultra-Low-Noise, Series Voltage Reference

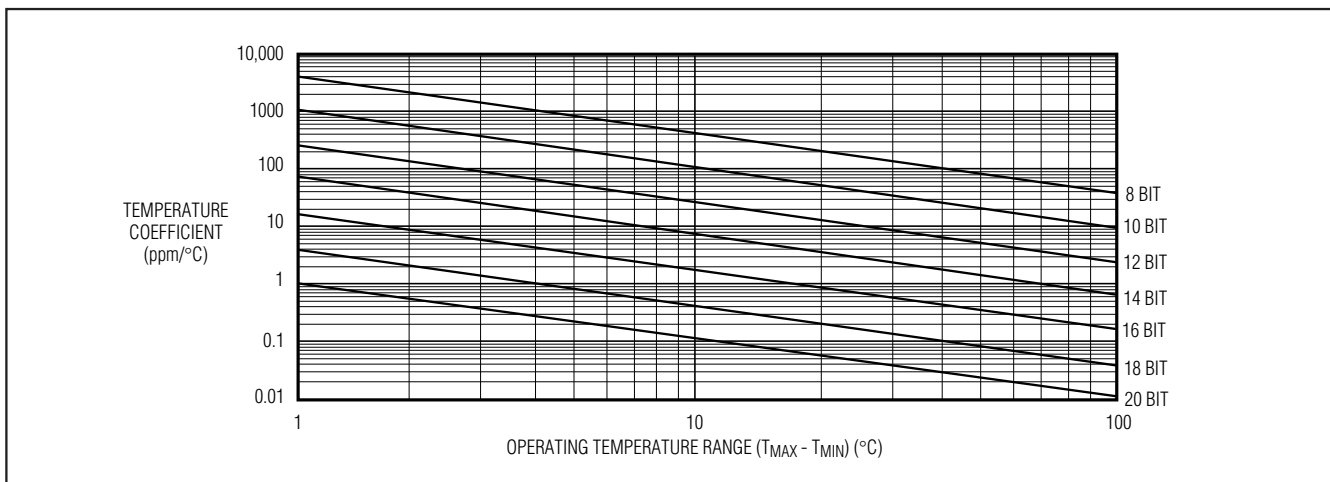
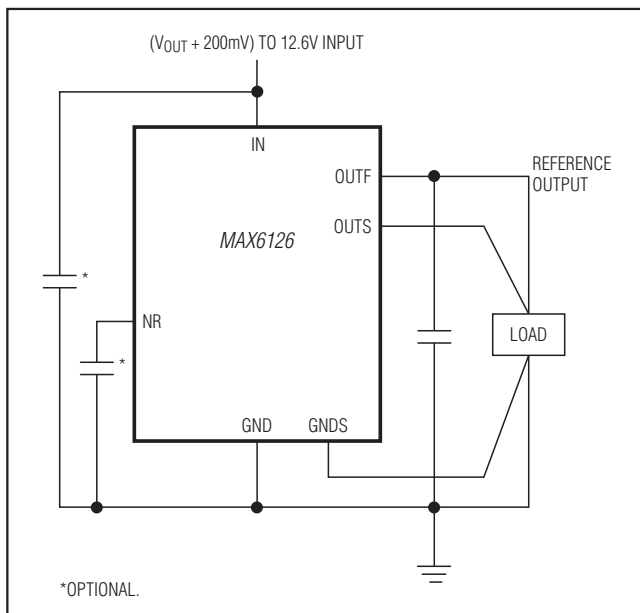

Figure 4. Temperature Coefficient vs. Operating Temperature Range for a 1 LSB Maximum Error

Typical Operating Circuit



Chip Information

PROCESS: BICMOS

MAX6126

Ultra-High-Precision, Ultra-Low-Noise, Series Voltage Reference

Ordering Information (continued)

| PART | TEMP RANGE | PIN-PACKAGE | OUTPUT VOLTAGE (V) | MAXIMUM INITIAL ACCURACY (%) | MAXIMUM TEMPCO (-40°C to +85°C) (ppm/°C) |
|------------------|-----------------|-------------|--------------------|------------------------------|--|
| MAX6126B21+ | -40°C to +125°C | 8 μ MAX | 2.048 | 0.1 | 7 |
| MAX6126AASA25+ | -40°C to +125°C | 8 SO | 2.500 | 0.02 | 3 |
| MAX6126BASA25+ | -40°C to +125°C | 8 SO | 2.500 | 0.06 | 5 |
| MAX6126A25+ | -40°C to +125°C | 8 μ MAX | 2.500 | 0.06 | 3 |
| MAX6126B25+ | -40°C to +125°C | 8 μ MAX | 2.500 | 0.1 | 7 |
| MAX6126A28+ | -40°C to +125°C | 8 μ MAX | 2.800 | 0.06 | 3 |
| MAX6126B28+ | -40°C to +125°C | 8 μ MAX | 2.800 | 0.1 | 7 |
| MAX6126AASA30+ | -40°C to +125°C | 8 SO | 3.000 | 0.02 | 3 |
| MAX6126BASA30+ | -40°C to +125°C | 8 SO | 3.000 | 0.06 | 5 |
| MAX6126A30+ | -40°C to +125°C | 8 μ MAX | 3.000 | 0.06 | 3 |
| MAX6126B30+ | -40°C to +125°C | 8 μ MAX | 3.000 | 0.1 | 7 |
| MAX6126AASA41+ | -40°C to +125°C | 8 SO | 4.096 | 0.02 | 3 |
| MAX6126BASA41+ | -40°C to +125°C | 8 SO | 4.096 | 0.06 | 5 |
| MAX6126BASA41/V+ | -40°C to +125°C | 8 SO | 4.096 | 0.06 | 5 |
| MAX6126A41+ | -40°C to +125°C | 8 μ MAX | 4.096 | 0.06 | 3 |
| MAX6126B41+ | -40°C to +125°C | 8 μ MAX | 4.096 | 0.1 | 7 |
| MAX6126AASA50+ | -40°C to +125°C | 8 SO | 5.000 | 0.02 | 3 |
| MAX6126BASA50+ | -40°C to +125°C | 8 SO | 5.000 | 0.06 | 5 |
| MAX6126A50+ | -40°C to +125°C | 8 μ MAX | 5.000 | 0.06 | 3 |
| MAX6126B50+ | -40°C to +125°C | 8 μ MAX | 5.000 | 0.1 | 7 |

+Denotes a lead(Pb)-free/RoHS-compliant package.

V denotes an automotive qualified part.

Package Information (continued)

For the latest package outline information and land patterns (footprints), go to www.maximintegrated.com/packages. Note that a "+", "#", or "-" in the package code indicates RoHS status only. Package drawings may show a different suffix character, but the drawing pertains to the package regardless of RoHS status.

| PACKAGE TYPE | PACKAGE CODE | OUTLINE NO. | LAND PATTERN NO. |
|--------------|--------------|-------------------------|-------------------------|
| 8 μ MAX | U8+1 | 21-0036 | 90-0092 |
| 8 SO | S8+4 | 21-0041 | 90-0096 |

MAX6126

Ultra-High-Precision, Ultra-Low-Noise, Series Voltage Reference

Revision History

| REVISION NUMBER | REVISION DATE | DESCRIPTION | PAGES CHANGED |
|-----------------|---------------|---|-----------------|
| 0 | 10/02 | Initial release | — |
| 1 | 3/03 | Remove “future product” and “contact factory” notes | 1, 16 |
| 2 | 6/03 | Add “A” grade devices | 1, 16 |
| 3 | 12/03 | Change μ MAX part number | 1, 16 |
| 4 | 7/04 | Add top mark to <i>Ordering Information</i> | 1, 16 |
| 5 | 12/10 | Add 2.8V option, add lead-free options, update <i>Package Information</i> | 1, 2, 4, 15, 16 |
| 6 | 8/12 | Added automotive package, MAX6126BASA41/V+ to data sheet | 17 |



Maxim Integrated cannot assume responsibility for use of any circuitry other than circuitry entirely embodied in a Maxim Integrated product. No circuit patent licenses are implied. Maxim Integrated reserves the right to change the circuitry and specifications without notice at any time. The parametric values (min and max limits) shown in the Electrical Characteristics table are guaranteed. Other parametric values quoted in this data sheet are provided for guidance.