



Chipsmall Limited consists of a professional team with an average of over 10 year of expertise in the distribution of electronic components. Based in Hongkong, we have already established firm and mutual-benefit business relationships with customers from,Europe,America and south Asia,supplying obsolete and hard-to-find components to meet their specific needs.

With the principle of “Quality Parts,Customers Priority,Honest Operation,and Considerate Service”,our business mainly focus on the distribution of electronic components. Line cards we deal with include Microchip,ALPS,ROHM,Xilinx,Pulse,ON,Everlight and Freescale. Main products comprise IC,Modules,Potentiometer,IC Socket,Relay,Connector.Our parts cover such applications as commercial,industrial, and automotives areas.

We are looking forward to setting up business relationship with you and hope to provide you with the best service and solution. Let us make a better world for our industry!



Contact us

Tel: +86-755-8981 8866 Fax: +86-755-8427 6832

Email & Skype: info@chipsmall.com Web: www.chipsmall.com

Address: A1208, Overseas Decoration Building, #122 Zhenhua RD., Futian, Shenzhen, China





Precision, Micropower, Low-Dropout, High-Output-Current, SO-8 Voltage References

General Description

The MAX6161–MAX6168 are precision, low-dropout, micropower voltage references. These three-terminal devices operate with an input voltage range from ($V_{OUT} + 200\text{mV}$) to 12.6V and are available with output voltage options of 1.25V, 1.8V, 2.048V, 2.5V, 3V, 4.096V, 4.5V, and 5V. They feature a proprietary curvature-correction circuit and laser-trimmed thin-film resistors that result in a very low temperature coefficient of 5ppm/°C (max) and an initial accuracy of $\pm 2\text{mV}$ (max). Specifications apply to the extended temperature range (-40°C to $+85^\circ\text{C}$).

The MAX6161–MAX6168 typically draw only 100 μA of supply current and can source 5mA (4mA for MAX6161) or sink 2mA of load current. Unlike conventional shunt-mode (two-terminal) references that waste supply current and require an external resistor, these devices offer a supply current that is virtually independent of the supply voltage (8 $\mu\text{A}/\text{V}$ variation) and do not require an external resistor. Additionally, the internally compensated devices do not require an external compensation capacitor. Eliminating the external compensation capacitor saves valuable board area in space-critical applications. A low-dropout voltage and a supply-independent, ultra-low supply current make these devices ideal for battery-operated, high-performance, low-voltage systems.

The MAX6161–MAX6168 are available in 8-pin SO packages.

Applications

Analog-to-Digital Converters (ADCs)
 Portable Battery-Powered Systems
 Notebook Computers
 PDAs, GPS, DMMs
 Cellular Phones
 Precision +3V/+5V Systems

Typical Operating Circuit and Selector Guide appear at end of data sheet.

Features

- ◆ $\pm 2\text{mV}$ (max) Initial Accuracy
- ◆ 5ppm/°C (max) Temperature Coefficient
- ◆ 5mA Source Current at 0.9mV/mA
- ◆ 2mA Sink Current at 2.5mV/mA
- ◆ Stable with 1 μF Capacitive Loads
- ◆ No External Capacitor Required
- ◆ 100 μA (typ) Quiescent Supply Current
- ◆ 200mV (max) Dropout at 1mA Load Current
- ◆ Output Voltage Options: 1.25V, 1.8V, 2.048V, 2.5V, 3V, 4.096V, 4.5V, 5V

Ordering Information

| PART* | TEMP RANGE | PIN-PACKAGE | OUTPUT VOLTAGE (V) |
|-------------|--|-------------|--------------------|
| MAX6161_ESA | -40°C to $+85^\circ\text{C}$ | 8 SO | 1.250 |
| MAX6162_ESA | -40°C to $+85^\circ\text{C}$ | 8 SO | 2.048 |
| MAX6163_ESA | -40°C to $+85^\circ\text{C}$ | 8 SO | 3.000 |
| MAX6164_ESA | -40°C to $+85^\circ\text{C}$ | 8 SO | 4.096 |
| MAX6165_ESA | -40°C to $+85^\circ\text{C}$ | 8 SO | 5.000 |
| MAX6166_ESA | -40°C to $+85^\circ\text{C}$ | 8 SO | 2.500 |
| MAX6167_ESA | -40°C to $+85^\circ\text{C}$ | 8 SO | 4.500 |
| MAX6168_ESA | -40°C to $+85^\circ\text{C}$ | 8 SO | 1.800 |

*Insert the code for the desired initial accuracy and temperature coefficient (from the Selector Guide) in the blank to complete the part number.

Pin Configuration

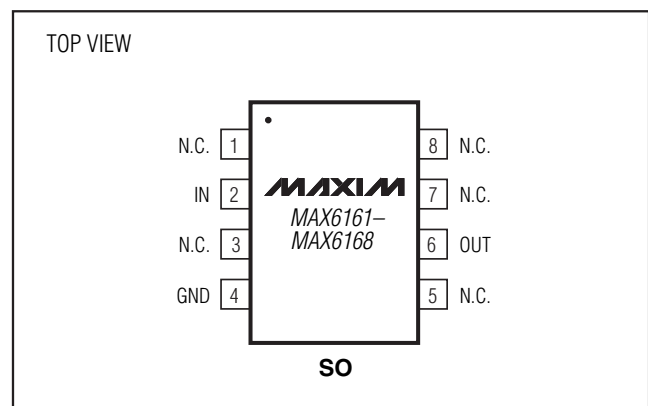

Precision, Micropower, Low-Dropout, High-Output-Current, SO-8 Voltage References

ABSOLUTE MAXIMUM RATINGS

Voltages Referenced to GND

IN-0.3 to +13.5V
 OUT.....-0.3V to ($V_{IN} + 0.3V$)
 Output Short-Circuit Duration to GND or IN ($V_{IN} \leq 6V$) ...Continuous
 Output Short-Circuit Duration to GND or IN ($V_{IN} > 6V$).....60s

Continuous Power Dissipation ($T_A = +70^\circ\text{C}$)

8-Pin SO (derate 5.88mW/ $^\circ\text{C}$ above $+70^\circ\text{C}$).....471mW
 Operating Temperature Range-40 $^\circ\text{C}$ to +85 $^\circ\text{C}$
 Storage Temperature Range.....-65 $^\circ\text{C}$ to +150 $^\circ\text{C}$
 Lead Temperature (soldering, 10s).....+300 $^\circ\text{C}$

Stresses beyond those listed under "Absolute Maximum Ratings" may cause permanent damage to the device. These are stress ratings only, and functional operation of the device at these or any other conditions beyond those indicated in the operational sections of the specifications is not implied. Exposure to absolute maximum rating conditions for extended periods may affect device reliability.

ELECTRICAL CHARACTERISTICS—MAX6161 ($V_{OUT} = 1.25V$)

($V_{IN} = +5V$, $I_{OUT} = 0$, $T_A = T_{MIN}$ to T_{MAX} , unless otherwise specified. Typical values are at $T_A = +25^\circ\text{C}$.) (Note 1)

| PARAMETER | SYMBOL | CONDITIONS | MIN | TYP | MAX | UNITS | |
|---|---|--|----------|-------|-------|-----------------------|---|
| Output Voltage | V_{OUT} | $T_A = +25^\circ\text{C}$ | MAX6161A | 1.248 | 1.250 | 1.252 | V |
| | | | MAX6161B | 1.246 | 1.250 | 1.254 | |
| Output Voltage Temperature Coefficient (Note 2) | TCV_{OUT} | MAX6161A | | 4 | 10 | ppm/ $^\circ\text{C}$ | |
| | | MAX6161B | | 6 | 15 | | |
| Line Regulation | $\frac{\Delta V_{OUT}}{\Delta V_{IN}}$ | $2.5V \leq V_{IN} \leq 12.6V$ | | 12 | 150 | $\mu\text{V/V}$ | |
| Load Regulation | $\frac{\Delta V_{OUT}}{\Delta I_{OUT}}$ | Sourcing: $0 \leq I_{OUT} \leq 4\text{mA}$ | | 0.5 | 0.9 | mV/mA | |
| | | Sinking: $-2\text{mA} \leq I_{OUT} \leq 0$ | | 1.3 | 2.5 | | |
| OUT Short-Circuit Current | I_{SC} | Short to GND | | 110 | | mA | |
| | | Short to IN | | 25 | | | |
| Long-Term Stability | $\frac{\Delta V_{OUT}}{\text{time}}$ | 1000hr at $+25^\circ\text{C}$ | | 115 | | ppm/1000hr | |
| Output Voltage Hysteresis (Note 3) | $\frac{\Delta V_{OUT}}{\text{cycle}}$ | | | 125 | | ppm | |

DYNAMIC CHARACTERISTICS

| | | | | | | |
|-----------------------|------------------|---|--|----|--|---------------------|
| Noise Voltage | e_{OUT} | $f = 0.1\text{Hz to }10\text{Hz}$ | | 20 | | $\mu\text{Vp-p}$ |
| | | $f = 10\text{Hz to }10\text{kHz}$ | | 15 | | μV_{RMS} |
| Ripple Rejection | V_{OUT}/V_{IN} | $V_{IN} = +5V \pm 100\text{mV}$, $f = 120\text{Hz}$ | | 80 | | dB |
| Turn-On Settling Time | t_R | V_{OUT} to 0.1% of final value, $C_{OUT} = 50\text{pF}$ | | 50 | | μs |

INPUT CHARACTERISTICS

| | | | | | | |
|--------------------------|-------------------------------|------------------------------------|-----|-----|------|-----------------|
| Supply Voltage Range | V_{IN} | Guaranteed by line-regulation test | 2.5 | | 12.6 | V |
| Quiescent Supply Current | I_{IN} | | | 125 | 150 | μA |
| Change in Supply Current | $\Delta I_{IN}/\Delta V_{IN}$ | $2.5V \leq V_{IN} \leq 12.6V$ | | 3.2 | 8.0 | $\mu\text{A/V}$ |

Precision, Micropower, Low-Dropout, High-Output-Current, SO-8 Voltage References

MAX6161-MAX6168

ELECTRICAL CHARACTERISTICS—MAX6168 (V_{OUT} = 1.800V)

(V_{IN} = +5V, I_{OUT} = 0, T_A = T_{MIN} to T_{MAX}, unless otherwise specified. Typical values are at T_A = +25°C.) (Note 1)

| PARAMETER | SYMBOL | CONDITIONS | MIN | TYP | MAX | UNITS | |
|---|---|--|----------|-------|-------|-------------------|---|
| Output Voltage | V _{OUT} | T _A = +25°C | MAX6168A | 1.798 | 1.800 | 1.802 | V |
| | | | MAX6168B | 1.795 | 1.800 | 1.805 | |
| Output Voltage Temperature Coefficient (Note 2) | TCV _{OUT} | MAX6168A | | 2 | 5 | ppm/°C | |
| | | MAX6168B | | 4 | 10 | | |
| Line Regulation | $\frac{\Delta V_{OUT}}{\Delta V_{IN}}$ | 2.5V ≤ V _{IN} ≤ 12.6V | | 42 | 200 | μV/V | |
| Load Regulation | $\frac{\Delta V_{OUT}}{\Delta I_{OUT}}$ | Sourcing: 0 ≤ I _{OUT} ≤ 5mA | | 0.5 | 0.9 | mV/mA | |
| | | Sinking: -2mA ≤ I _{OUT} ≤ 0 | | 1.5 | 4 | | |
| OUT Short-Circuit Current | I _{SC} | Short to GND | | 110 | | mA | |
| | | Short to IN | | 25 | | | |
| Long-Term Stability | $\frac{\Delta V_{OUT}}{\text{time}}$ | 1000hr at +25°C | | 80 | | ppm/1000hr | |
| Output Voltage Hysteresis (Note 3) | $\frac{\Delta V_{OUT}}{\text{cycle}}$ | | | 125 | | ppm | |
| DYNAMIC CHARACTERISTICS | | | | | | | |
| Noise Voltage | e _{OUT} | f = 0.1Hz to 10Hz | | 22 | | μVp-p | |
| | | f = 10Hz to 10kHz | | 25 | | μV _{RMS} | |
| Ripple Rejection | $\frac{\Delta V_{OUT}}{\Delta V_{IN}}$ | V _{IN} = +5V ±100mV, f = 120Hz | | 78 | | dB | |
| Turn-On Settling Time | t _R | V _{OUT} to 0.1% of final value, C _{OUT} = 50pF | | 100 | | μs | |
| INPUT CHARACTERISTICS | | | | | | | |
| Supply Voltage Range | V _{IN} | Guaranteed by line-regulation test | 2.5 | | 12.6 | V | |
| Quiescent Supply Current | I _{IN} | | | 100 | 120 | μA | |
| Change in Supply Current | $\Delta I_{IN}/\Delta V_{IN}$ | 2.5V ≤ V _{IN} ≤ 12.6V | | 3.4 | 8.0 | μA/V | |

Precision, Micropower, Low-Dropout, High-Output-Current, SO-8 Voltage References

ELECTRICAL CHARACTERISTICS—MAX6162 (V_{OUT} = 2.048V)

(V_{IN} = +5V, I_{OUT} = 0, T_A = T_{MIN} to T_{MAX}, unless otherwise specified. Typical values are at T_A = +25°C.) (Note 1)

| PARAMETER | SYMBOL | CONDITIONS | MIN | TYP | MAX | UNITS | |
|---|--|--|----------|-------|-------|-------------------|---|
| Output Voltage | V _{OUT} | T _A = +25°C | MAX6162A | 2.046 | 2.048 | 2.050 | V |
| | | | MAX6162B | 2.043 | 2.048 | 2.053 | |
| Output Voltage Temperature Coefficient (Note 2) | TCV _{OUT} | MAX6162A | | 2 | 5 | ppm/°C | |
| | | MAX6162B | | 4 | 10 | | |
| Line Regulation | ΔV _{OUT} / | 2.5V ≤ V _{IN} ≤ 12.6V | | 42 | 250 | μV/V | |
| Load Regulation | ΔV _{OUT} / ΔI _{OUT} | Sourcing: 0 ≤ I _{OUT} ≤ 5mA | | 0.5 | 0.9 | mV/mA | |
| | | Sinking: -2mA ≤ I _{OUT} ≤ 0 | | 1.5 | 4 | | |
| OUT Short-Circuit Current | I _{SC} | Short to GND | | 110 | | mA | |
| | | Short to IN | | 25 | | | |
| Long-Term Stability | ΔV _{OUT} / time | 1000hr at +25°C | | 80 | | ppm/ 1000hr | |
| Output Voltage Hysteresis (Note 3) | ΔV _{OUT} / cycle | | | 125 | | ppm | |
| DYNAMIC CHARACTERISTICS | | | | | | | |
| Noise Voltage | e _{OUT} | f = 0.1Hz to 10Hz | | 22 | | μVp-p | |
| | | f = 10Hz to 10kHz | | 25 | | μV _{RMS} | |
| Ripple Rejection | V _{OUT} /V _{IN} | V _{IN} = 5V ±100mV, f = 120Hz | | 78 | | dB | |
| Turn-On Settling Time | t _R | V _{OUT} to 0.1% of final value, C _{OUT} = 50pF | | 100 | | μs | |
| INPUT CHARACTERISTICS | | | | | | | |
| Supply Voltage Range | V _{IN} | Guaranteed by line-regulation test | 2.5 | | 12.6 | V | |
| Quiescent Supply Current | I _{IN} | | | 100 | 120 | μA | |
| Change in Supply Current | ΔI _{IN} /ΔV _{IN} | 2.5V ≤ V _{IN} ≤ 12.6V | | 3.4 | 8.0 | μA/V | |

Precision, Micropower, Low-Dropout, High-Output-Current, SO-8 Voltage References

MAX6161-MAX6168

ELECTRICAL CHARACTERISTICS—MAX6166 (V_{OUT} = 2.500V)

(V_{IN} = +5V, I_{OUT} = 0, T_A = T_{MIN} to T_{MAX}, unless otherwise specified. Typical values are at T_A = +25°C.) (Note 1)

| PARAMETER | SYMBOL | CONDITIONS | MIN | TYP | MAX | UNITS | |
|---|---|--|----------|------------------------|-------|-------------------|---|
| Output Voltage | V _{OUT} | T _A = +25°C | MAX6166A | 2.498 | 2.500 | 2.502 | V |
| | | | MAX6166B | 2.495 | 2.500 | 2.505 | |
| Output Voltage Temperature Coefficient (Note 2) | TCV _{OUT} | MAX6166A | | 2 | 5 | ppm/°C | |
| | | MAX6166B | | 4 | 10 | | |
| Dropout Voltage (Note 4) | V _{IN} - V _{OUT} | I _{OUT} = 1mA | | 50 | 200 | mV | |
| Line Regulation | $\frac{\Delta V_{OUT}}{\Delta V_{IN}}$ | V _{OUT} + 0.2V ≤ V _{IN} ≤ 12.6V | | 60 | 250 | μV/V | |
| Load Regulation | $\frac{\Delta V_{OUT}}{\Delta I_{OUT}}$ | Sourcing: 0 ≤ I _{OUT} ≤ 5mA | | 0.5 | 0.9 | mV/mA | |
| | | Sinking: -2mA ≤ I _{OUT} ≤ 0 | | 1.6 | 5 | | |
| OUT Short-Circuit Current | I _{SC} | Short to GND | | 110 | | mA | |
| | | Short to IN | | 25 | | | |
| Long-Term Stability | $\frac{\Delta V_{OUT}}{\text{time}}$ | 1000hr at +25°C | | 80 | | ppm/1000hr | |
| Output Voltage Hysteresis (Note 3) | $\frac{\Delta V_{OUT}}{\text{cycle}}$ | | | 125 | | ppm | |
| DYNAMIC CHARACTERISTICS | | | | | | | |
| Noise Voltage | e _{OUT} | f = 0.1Hz to 10Hz | | 27 | | μVp-p | |
| | | f = 10Hz to 10kHz | | 30 | | μV _{RMS} | |
| Ripple Rejection | V _{OUT} /V _{IN} | V _{IN} = 5V ±100mV, f = 120Hz | | 76 | | dB | |
| Turn-On Settling Time | t _R | V _{OUT} to 0.1% of final value, C _{OUT} = 50pF | | 115 | | μs | |
| INPUT CHARACTERISTICS | | | | | | | |
| Supply Voltage Range | V _{IN} | Guaranteed by line-regulation test | | V _{OUT} + 0.2 | 12.6 | V | |
| Quiescent Supply Current | I _{IN} | | | 100 | 120 | μA | |
| Change in Supply Current | $\Delta I_{IN}/\Delta V_{IN}$ | V _{OUT} + 0.2V ≤ V _{IN} ≤ 12.6V | | 3.2 | 8.0 | μA/V | |

Precision, Micropower, Low-Dropout, High-Output-Current, SO-8 Voltage References

ELECTRICAL CHARACTERISTICS—MAX6163 (V_{OUT} = 3.000V)

(V_{IN} = +5V, I_{OUT} = 0, T_A = T_{MIN} to T_{MAX}, unless otherwise specified. Typical values are at T_A = +25°C.) (Note 1)

| PARAMETER | SYMBOL | CONDITIONS | MIN | TYP | MAX | UNITS | |
|---|---|--|----------|------------------------|-------|-------------------|---|
| Output Voltage | V _{OUT} | T _A = +25°C | MAX6163A | 2.998 | 3.000 | 3.002 | V |
| | | | MAX6163B | 2.995 | 3.000 | 3.005 | |
| Output Voltage Temperature Coefficient (Note 2) | TCV _{OUT} | MAX6163A | | 2 | 5 | ppm/°C | |
| | | MAX6163B | | 4 | 10 | | |
| Dropout Voltage (Note 4) | V _{IN} - V _{OUT} | I _{OUT} = 1mA | | 50 | 200 | mV | |
| Line Regulation | $\frac{\Delta V_{OUT}}{\Delta V_{IN}}$ | V _{OUT} + 0.2V ≤ V _{IN} ≤ 12.6V | | 83 | 300 | μV/V | |
| Load Regulation | $\frac{\Delta V_{OUT}}{\Delta I_{OUT}}$ | Sourcing: 0 ≤ I _{OUT} ≤ 5mA | | 0.5 | 0.9 | mV/mA | |
| | | Sinking: -2mA ≤ I _{OUT} ≤ 0 | | 1.8 | 5 | | |
| OUT Short-Circuit Current | I _{SC} | Short to GND | | 110 | | mA | |
| | | Short to IN | | 25 | | | |
| Long-Term Stability | $\frac{\Delta V_{OUT}}{\text{time}}$ | 1000hr at +25°C | | 80 | | ppm/1000hr | |
| Output Voltage Hysteresis (Note 3) | $\frac{\Delta V_{OUT}}{\text{cycle}}$ | | | 125 | | ppm | |
| DYNAMIC CHARACTERISTICS | | | | | | | |
| Noise Voltage | e _{OUT} | f = 0.1Hz to 10Hz | | 35 | | μVp-p | |
| | | f = 10Hz to 10kHz | | 40 | | μV _{RMS} | |
| Ripple Rejection | V _{OUT} /V _{IN} | V _{IN} = 5V ±100mV, f = 120Hz | | 76 | | dB | |
| Turn-On Settling Time | t _R | V _{OUT} to 0.1% of final value, C _{OUT} = 50pF | | 115 | | μs | |
| INPUT CHARACTERISTICS | | | | | | | |
| Supply Voltage Range | V _{IN} | Guaranteed by line-regulation test | | V _{OUT} + 0.2 | 12.6 | V | |
| Quiescent Supply Current | I _{IN} | | | 100 | 120 | μA | |
| Change in Supply Current | ΔI _{IN} /ΔV _{IN} | V _{OUT} + 0.2V ≤ V _{IN} ≤ 12.6V | | 3.2 | 8.0 | μA/V | |

Precision, Micropower, Low-Dropout, High-Output-Current, SO-8 Voltage References

MAX6161-MAX6168

ELECTRICAL CHARACTERISTICS—MAX6164 (V_{OUT} = 4.096V)

(V_{IN} = +5V, I_{OUT} = 0, T_A = T_{MIN} to T_{MAX}, unless otherwise specified. Typical values are at T_A = +25°C.) (Note 1)

| PARAMETER | SYMBOL | CONDITIONS | MIN | TYP | MAX | UNITS | |
|---|---|--|----------|------------------------|-------|-------------------|---|
| Output Voltage | V _{OUT} | T _A = +25°C | MAX6164A | 4.094 | 4.096 | 4.098 | V |
| | | | MAX6164B | 4.091 | 4.096 | 4.101 | |
| Output Voltage Temperature Coefficient (Note 2) | TCV _{OUT} | MAX6164A | | 2 | 5 | ppm/°C | |
| | | MAX6164B | | 4 | 10 | | |
| Dropout Voltage (Note 4) | V _{IN} - V _{OUT} | I _{OUT} = 1mA | | 50 | 200 | mV | |
| Line Regulation | $\frac{\Delta V_{OUT}}{\Delta V_{IN}}$ | V _{OUT} + 0.2V ≤ V _{IN} ≤ 12.6V | | 140 | 300 | μV/V | |
| Load Regulation | $\frac{\Delta V_{OUT}}{\Delta I_{OUT}}$ | Sourcing: 0 ≤ I _{OUT} ≤ 5mA | | 0.6 | 0.9 | mV/mA | |
| | | Sinking: -2mA ≤ I _{OUT} ≤ 0 | | 2.0 | 7.0 | | |
| OUT Short-Circuit Current | I _{SC} | Short to GND | | 110 | | mA | |
| | | Short to IN | | 25 | | | |
| Long-Term Stability | $\frac{\Delta V_{OUT}}{\text{time}}$ | 1000hr at +25°C | | 80 | | ppm/1000hr | |
| Output Voltage Hysteresis (Note 3) | $\frac{\Delta V_{OUT}}{\text{cycle}}$ | | | 125 | | ppm | |
| DYNAMIC CHARACTERISTICS | | | | | | | |
| Noise Voltage | e _{OUT} | f = 0.1Hz to 10Hz | | 50 | | μVp-p | |
| | | f = 10Hz to 10kHz | | 50 | | μV _{RMS} | |
| Ripple Rejection | V _{OUT} /V _{IN} | V _{IN} = 5V ±100mV, f = 120Hz | | 72 | | dB | |
| Turn-On Settling Time | t _R | V _{OUT} to 0.1% of final value, C _{OUT} = 50pF | | 190 | | μs | |
| INPUT CHARACTERISTICS | | | | | | | |
| Supply Voltage Range | V _{IN} | Guaranteed by line-regulation test | | V _{OUT} + 0.2 | 12.6 | V | |
| Quiescent Supply Current | I _{IN} | | | 100 | 120 | μA | |
| Change in Supply Current | ΔI _{IN} /ΔV _{IN} | V _{OUT} + 0.2V ≤ V _{IN} ≤ 12.6V | | 3.2 | 8.0 | μA/V | |

Precision, Micropower, Low-Dropout, High-Output-Current, SO-8 Voltage References

ELECTRICAL CHARACTERISTICS—MAX6167 ($V_{OUT} = 4.500V$)

($V_{IN} = +5V$, $I_{OUT} = 0$, $T_A = T_{MIN}$ to T_{MAX} , unless otherwise specified. Typical values are at $T_A = +25^\circ C$.) (Note 1)

| PARAMETER | SYMBOL | CONDITIONS | MIN | TYP | MAX | UNITS | |
|---|---|--|----------|-----------------|-------|-----------------|---|
| Output Voltage | V_{OUT} | $T_A = +25^\circ C$ | MAX6167A | 4.498 | 4.500 | 4.502 | V |
| | | | MAX6167B | 4.495 | 4.500 | 4.505 | |
| Output Voltage Temperature Coefficient (Note 2) | TCV_{OUT} | MAX6167A | | 2 | 5 | ppm/ $^\circ C$ | |
| | | MAX6167B | | 4 | 10 | | |
| Dropout Voltage (Note 4) | $V_{IN} - V_{OUT}$ | $I_{OUT} = 1mA$ | | 50 | 200 | mV | |
| Line Regulation | $\frac{\Delta V_{OUT}}{\Delta V_{IN}}$ | $V_{OUT} + 0.2V \leq V_{IN} \leq 12.6V$ | | 160 | 450 | $\mu V/V$ | |
| Load Regulation | $\frac{\Delta V_{OUT}}{\Delta I_{OUT}}$ | Sourcing: $0 \leq I_{OUT} \leq 5mA$ | | 0.6 | 0.9 | mV/mA | |
| | | Sinking: $-2mA \leq I_{OUT} \leq 0$ | | 2.3 | 8.0 | | |
| OUT Short-Circuit Current | I_{SC} | Short to GND | | 110 | | mA | |
| | | Short to IN | | 25 | | | |
| Long-Term Stability | $\frac{\Delta V_{OUT}}{\text{time}}$ | 1000hr at $+25^\circ C$ | | 80 | | ppm/1000hr | |
| Output Voltage Hysteresis (Note 3) | $\frac{\Delta V_{OUT}}{\text{cycle}}$ | | | 125 | | ppm | |
| DYNAMIC CHARACTERISTICS | | | | | | | |
| Noise Voltage | e_{OUT} | $f = 0.1Hz$ to $10Hz$ | | 55 | | $\mu Vp-p$ | |
| | | $f = 10Hz$ to $10kHz$ | | 55 | | μV_{RMS} | |
| Ripple Rejection | V_{OUT}/V_{IN} | $V_{IN} = 5V \pm 100mV$, $f = 120Hz$ | | 70 | | dB | |
| Turn-On Settling Time | t_R | V_{OUT} to 0.1% of final value, $C_{OUT} = 50pF$ | | 230 | | μs | |
| INPUT CHARACTERISTICS | | | | | | | |
| Supply Voltage Range | V_{IN} | Guaranteed by line-regulation test | | $V_{OUT} + 0.2$ | 12.6 | V | |
| Quiescent Supply Current | I_{IN} | | | 100 | 120 | μA | |
| Change in Supply Current | $\Delta I_{IN}/\Delta V_{IN}$ | $V_{OUT} + 0.2V \leq V_{IN} \leq 12.6V$ | | 3.1 | 8.0 | $\mu A/V$ | |

Precision, Micropower, Low-Dropout, High-Output-Current, SO-8 Voltage References

MAX6161-MAX6168

ELECTRICAL CHARACTERISTICS—MAX6165 (V_{OUT} = 5.000V)

(V_{IN} = +5.5V, I_{OUT} = 0, T_A = T_{MIN} to T_{MAX}, unless otherwise specified. Typical values are at T_A = +25°C.) (Note 1)

| PARAMETER | SYMBOL | CONDITIONS | MIN | TYP | MAX | UNITS | |
|---|------------------------------------|--|----------|------------------------|-------|-------------------|---|
| Output Voltage | V _{OUT} | T _A = +25°C | MAX6165A | 4.998 | 5.000 | 5.002 | V |
| | | | MAX6165B | 4.995 | 5.000 | 5.005 | |
| Output Voltage Temperature Coefficient (Note 2) | TCV _{OUT} | MAX6165A | | 2 | 5 | ppm/°C | |
| | | MAX6165B | | 4 | 10 | | |
| Dropout Voltage (Note 4) | V _{IN} - V _{OUT} | I _{OUT} = 1mA | | 50 | 200 | mV | |
| Line Regulation | ΔV _{OUT} / | V _{OUT} + 0.2V ≤ V _{IN} ≤ 12.6V | | 180 | 400 | μV/V | |
| Load Regulation | ΔV _{OUT} / | Sourcing: 0 ≤ I _{OUT} ≤ 5mA | | 0.6 | 0.9 | mV/mA | |
| | | Sinking: -2mA ≤ I _{OUT} ≤ 0 | | 2.4 | 8.0 | | |
| OUT Short-Circuit Current | I _{SC} | Short to GND | | 110 | | mA | |
| | | Short to IN | | 25 | | | |
| Long-Term Stability | ΔV _{OUT} / | 1000hr at +25°C | | 80 | | ppm/1000hr | |
| Output Voltage Hysteresis (Note 3) | ΔV _{OUT} / | cycle | | 125 | | ppm | |
| DYNAMIC CHARACTERISTICS | | | | | | | |
| Noise Voltage | e _{OUT} | f = 0.1Hz to 10Hz | | 60 | | μVp-p | |
| | | f = 10Hz to 10kHz | | 60 | | μV _{RMS} | |
| Ripple Rejection | V _{OUT} /V _{IN} | V _{IN} = 5.5V ±100mV, f = 120Hz | | 65 | | dB | |
| Turn-On Settling Time | t _R | V _{OUT} to 0.1% of final value, C _{OUT} = 50pF | | 300 | | μs | |
| INPUT CHARACTERISTICS | | | | | | | |
| Supply Voltage Range | V _{IN} | Guaranteed by line-regulation test | | V _{OUT} + 0.2 | 12.6 | V | |
| Quiescent Supply Current | I _{IN} | | | 100 | 120 | μA | |
| Change in Supply Current | ΔI _{IN} /ΔV _{IN} | V _{OUT} + 0.2V ≤ V _{IN} ≤ 12.6V | | 3.1 | 8.0 | μA/V | |

Note 1: 100% production tested at T_A = +25°C. Guaranteed by design for T_A = -40°C to +85°C.

Note 2: Temperature Coefficient is specified by the “box” method; i.e., the maximum ΔV_{OUT} is divided by the maximum ΔT.

Note 3: Thermal Hysteresis is defined as the change in T_A = +25°C output voltage before and after temperature cycling of the device (from T_A = T_{MIN} to T_{MAX}). Initial measurement at T_A = +25°C is followed by temperature cycling the device to T_A = +85°C then to T_A = -40°C, and another measurement at T_A = +25°C is compared to the original measurement at T_A = +25°C.

Note 4: Dropout voltage is the minimum input voltage at which V_{OUT} changes ≤ 0.2% from V_{OUT} at V_{IN} = 5.0V (V_{IN} = 5.5V for MAX6165).

Precision, Micropower, Low-Dropout, High-Output-Current, SO-8 Voltage References

Typical Operating Characteristics

($V_{IN} = +5V$ for MAX6161-MAX6168, $V_{IN} = +5.5V$ for MAX6165, $I_{OUT} = 0$, $T_A = +25^\circ C$, unless otherwise noted.) (Note 5)

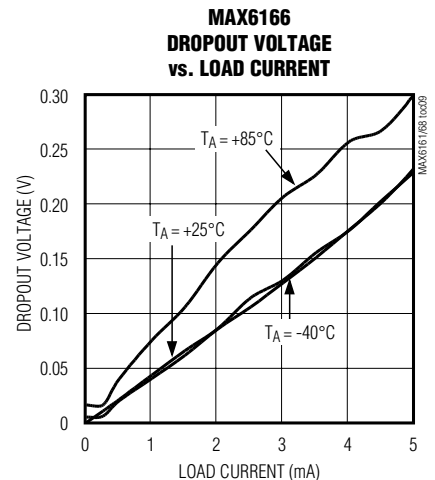
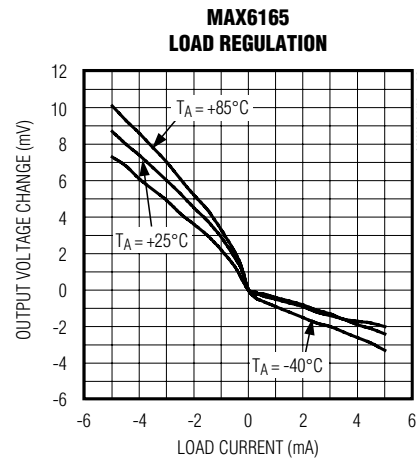
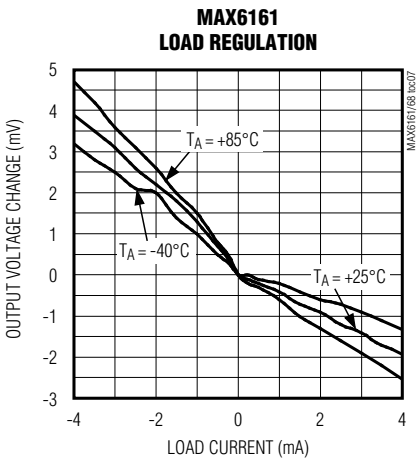
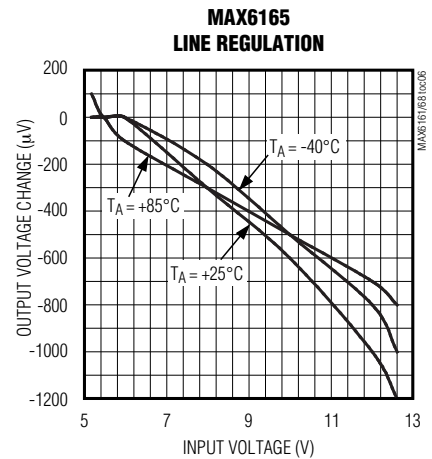
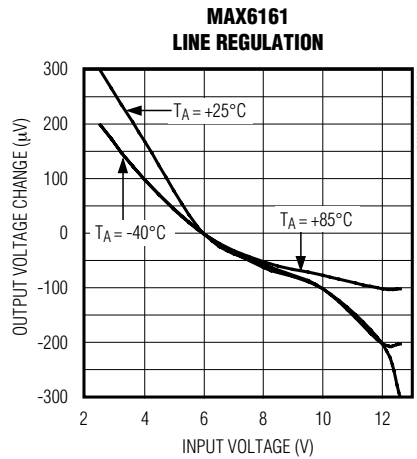
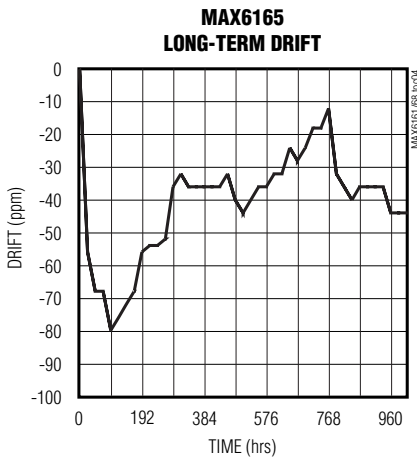
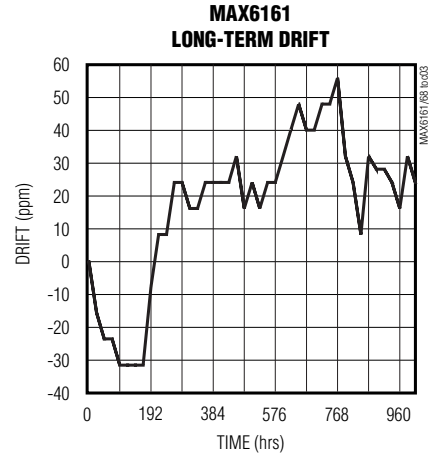
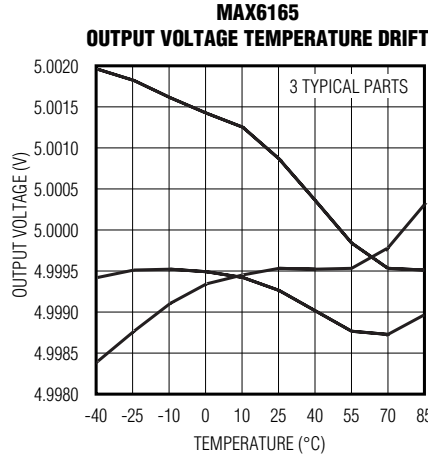
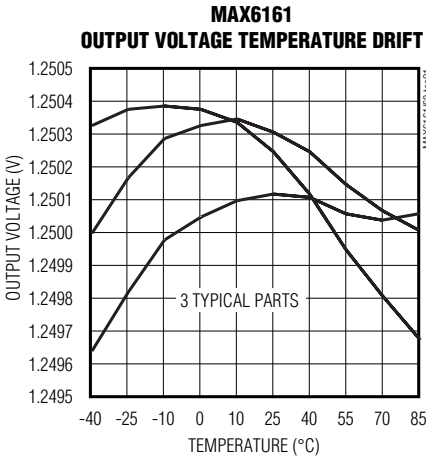

Precision, Micropower, Low-Dropout, High-Output-Current, SO-8 Voltage References

Typical Operating Characteristics (continued)

($V_{IN} = +5V$ for MAX6161–MAX6168, $V_{IN} = +5.5V$ for MAX6165, $I_{OUT} = 0$, $T_A = +25^\circ C$, unless otherwise noted.) (Note 5)

MAX6161–MAX6168

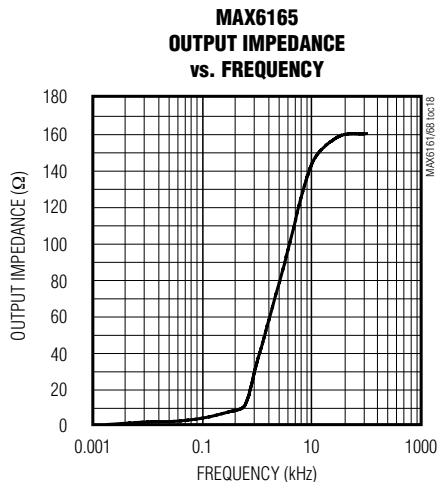
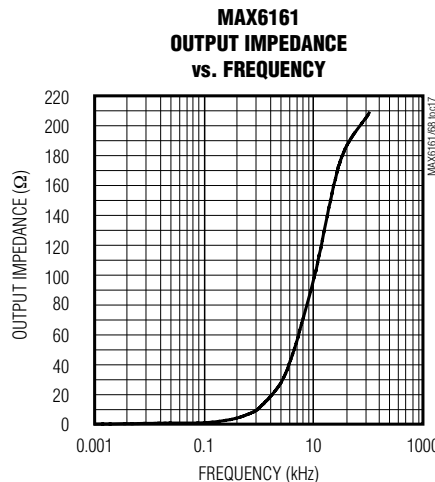
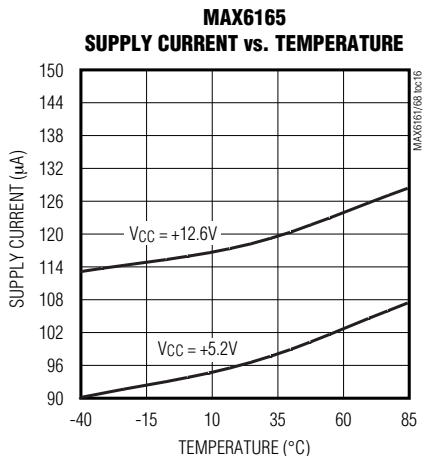
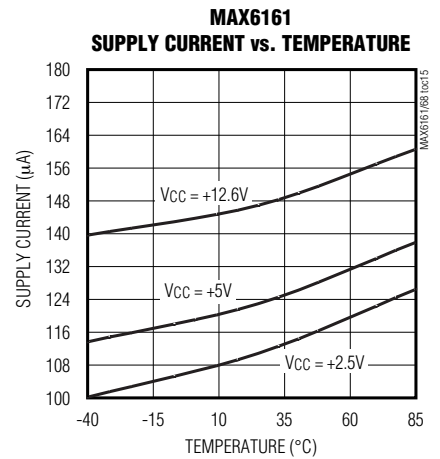
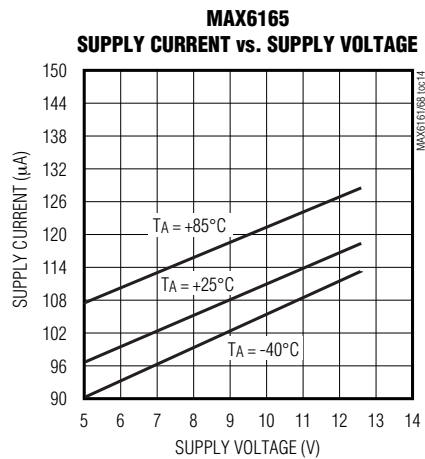
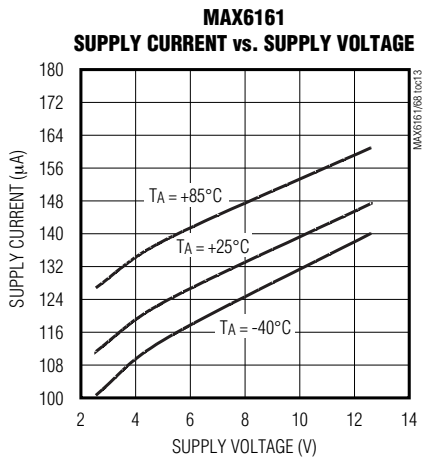
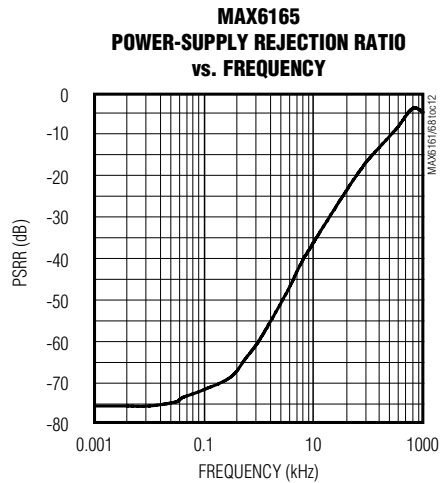
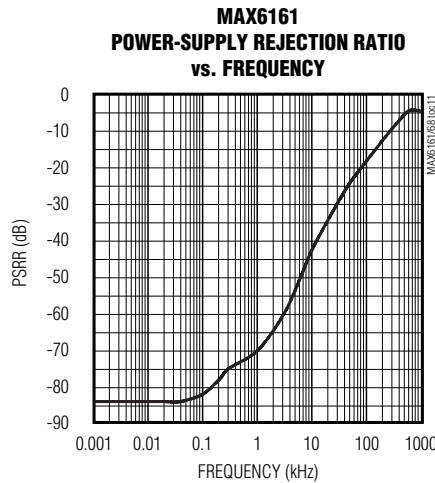
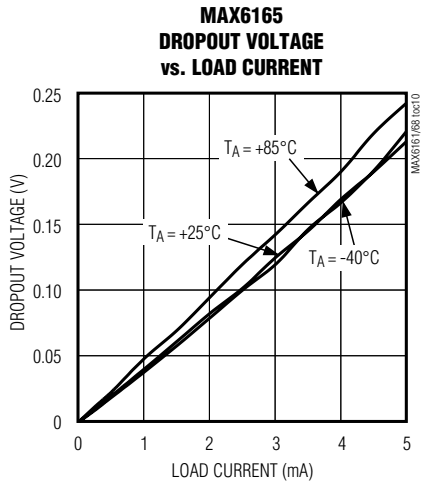

Precision, Micropower, Low-Dropout, High-Output-Current, SO-8 Voltage References

Typical Operating Characteristics (continued)

($V_{IN} = +5V$ for MAX6161-MAX6168, $V_{IN} = +5.5V$ for MAX6165, $I_{OUT} = 0$, $T_A = +25^\circ C$, unless otherwise noted.) (Note 5)

**MAX6161
0.1Hz TO 10Hz OUTPUT NOISE**

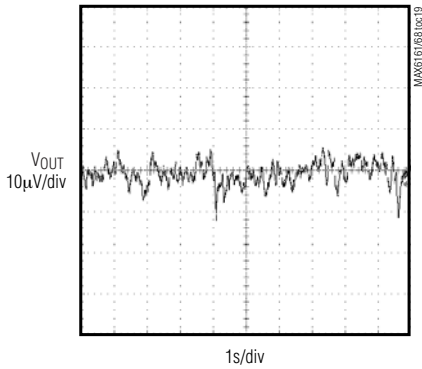

**MAX6165
NOISE**

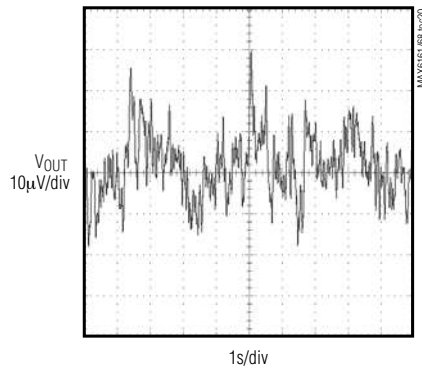

**MAX6161
TURN-ON TRANSIENT
($C_L = 50pF$)**

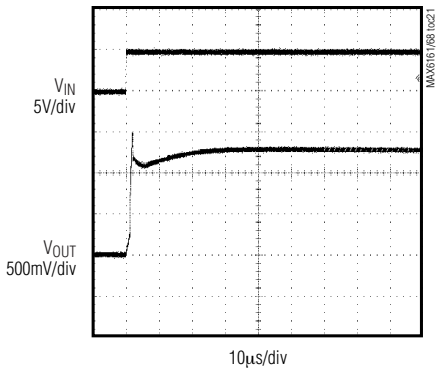

**MAX6165
TURN-ON TRANSIENT
($C_L = 50pF$)**

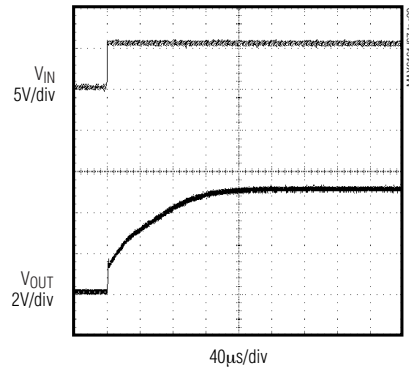

**MAX6161
LOAD TRANSIENT
($I_{OUT} = \pm 250\mu A$, $V_{IN} = 5.0$, $C_L = 0$)**

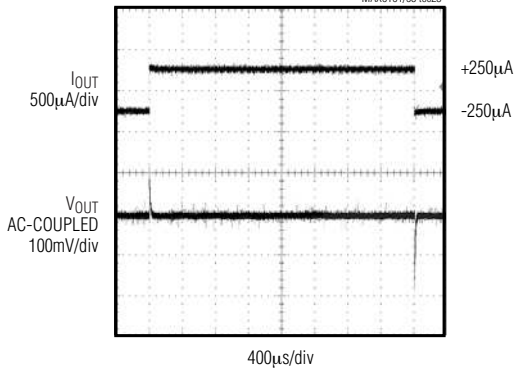

**MAX6165
LOAD TRANSIENT
($I_{OUT} = \pm 250\mu A$, $C_L = 0$, $V_{IN} = 5.5V$)**

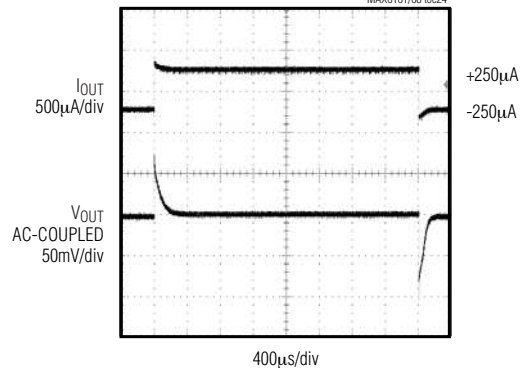

Precision, Micropower, Low-Dropout, High-Output-Current, SO-8 Voltage References

Typical Operating Characteristics (continued)

($V_{IN} = +5V$ for MAX6161–MAX6168, $V_{IN} = +5.5V$ for MAX6165, $I_{OUT} = 0$, $T_A = +25^\circ C$, unless otherwise noted.) (Note 5)

MAX6161–MAX6168

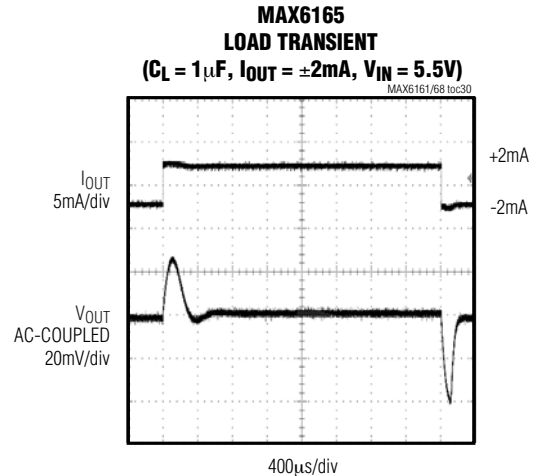
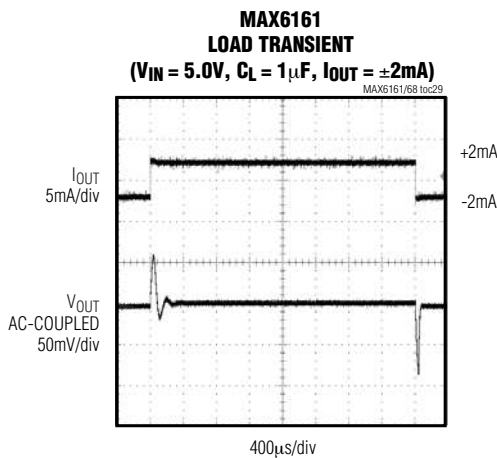
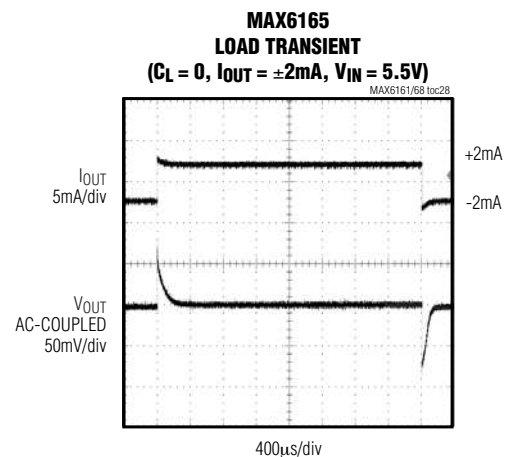
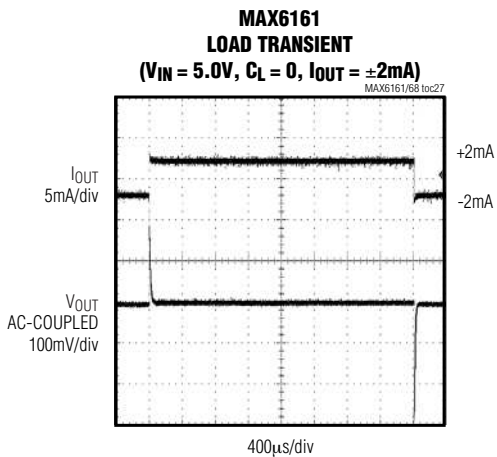
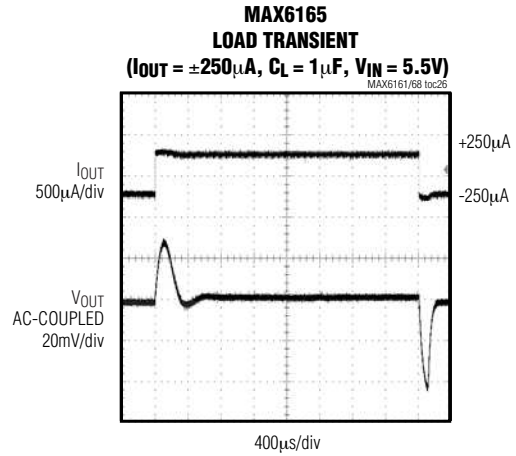
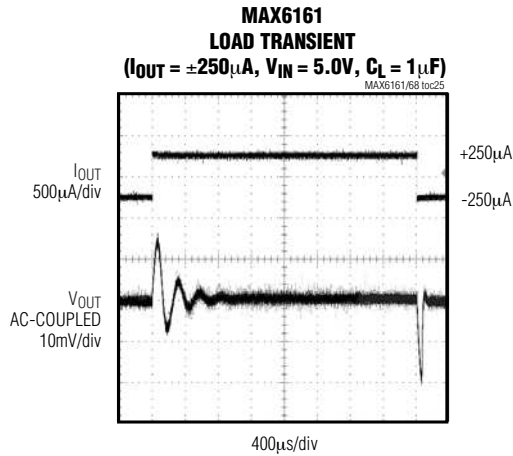

Precision, Micropower, Low-Dropout, High-Output-Current, SO-8 Voltage References

Typical Operating Characteristics (continued)

($V_{IN} = +5V$ for MAX6161-MAX6168, $V_{IN} = +5.5V$ for MAX6165, $I_{OUT} = 0$, $T_A = +25^\circ C$, unless otherwise noted.) (Note 5)

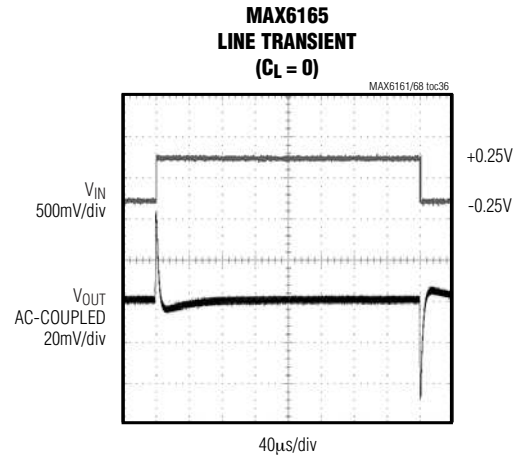
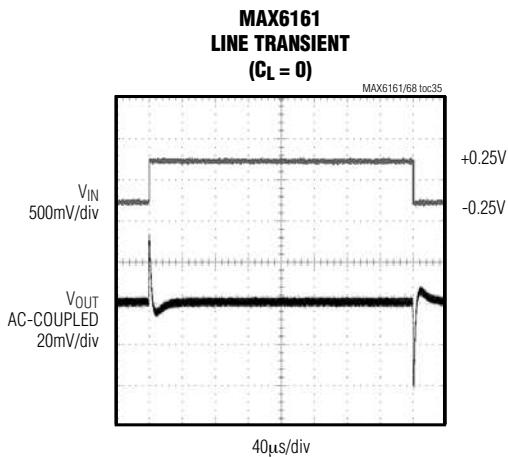
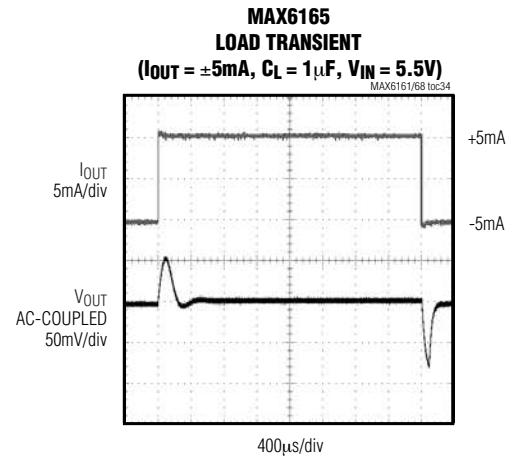
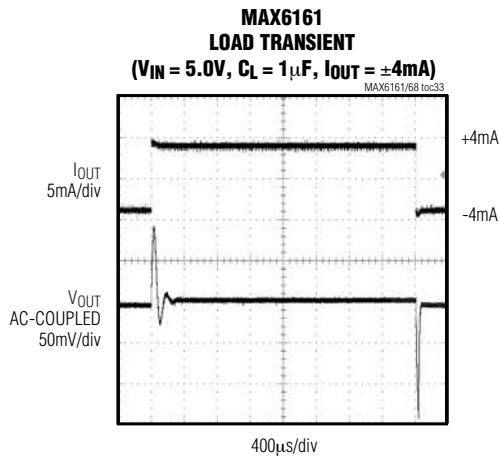
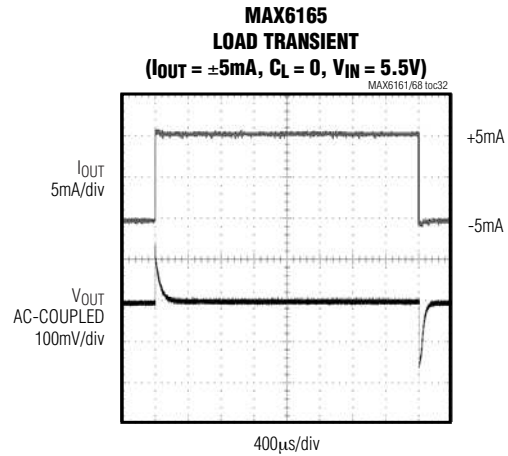
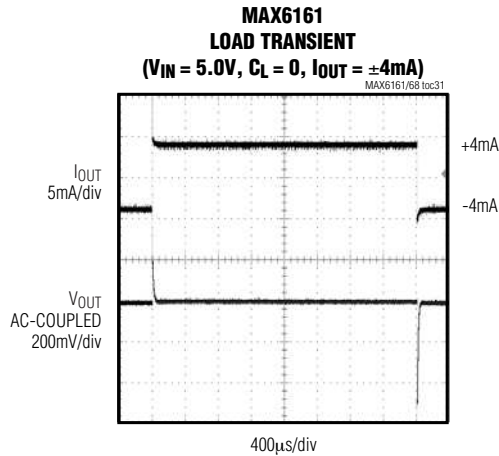

Note 5: Many of the *Typical Operating Characteristics* of the MAX6161 family are extremely similar. The extremes of these characteristics are found in the MAX6161 (1.25V output) and the MAX6165 (5.0V output). The *Typical Operating Characteristics* of the remainder of the MAX6161 family typically lie between these two extremes and can be estimated based on their output voltages.

Precision, Micropower, Low-Dropout, High-Output-Current, SO-8 Voltage References

MAX6161-MAX6168

Pin Description

| PIN | NAME | FUNCTION |
|---------------|------|--|
| 1, 3, 5, 7, 8 | N.C. | No Connection. Not internally connected. |
| 2 | IN | Input Voltage |
| 4 | GND | Ground |
| 6 | OUT | Reference Output |

Applications Information

Input Bypassing

For the best line-transient performance, decouple the input with a 0.1 μ F ceramic capacitor as shown in the *Typical Operating Circuit*. Locate the capacitor as close to IN as possible. When transient performance is less important, no capacitor is necessary.

Output/Load Capacitance

Devices in the MAX6161 family do not require an output capacitor for frequency stability. In applications where the load or the supply can experience step changes, an output capacitor of at least 0.1 μ F will reduce the amount of overshoot (undershoot) and improve the circuit's transient response. Many applications do not require an external capacitor, and the MAX6161 family can offer a significant advantage in applications when board space is critical.

Supply Current

The quiescent supply current of the series-mode MAX6161 family is typically 100 μ A and is virtually independent of the supply voltage, with only an 8 μ A/V (max) variation with supply voltage. Unlike series references, shunt-mode references operate with a series resistor connected to the power supply. The quiescent current of a shunt-mode reference is thus a function of the input voltage. Additionally, shunt-mode references have to be biased at the maximum expected load current, even if the load current is not present at the time. In the MAX6161 family, the load current is drawn from the input voltage only when required, so supply current is not wasted and efficiency is maximized at all input voltages. This improved efficiency reduces power dissipation and extends battery life.

When the supply voltage is below the minimum specified input voltage (as during turn-on), the devices can draw up to 400 μ A beyond the nominal supply current. The input voltage source must be capable of providing this current to ensure reliable turn-on.

Output Voltage Hysteresis

Output voltage hysteresis is the change in the input voltage at $T_A = +25^\circ\text{C}$ before and after the device is cycled over its entire operating temperature range. Hysteresis is caused by differential package stress appearing across the bandgap core transistors. The typical temperature hysteresis value is 125ppm.

Turn-On Time

These devices typically turn on and settle to within 0.1% of their final value in 50 μ s to 300 μ s, depending on the output voltage (see electrical table of part used). The turn-on time can increase up to 1.5ms with the device operating at the minimum dropout voltage and the maximum load.

Typical Operating Circuit

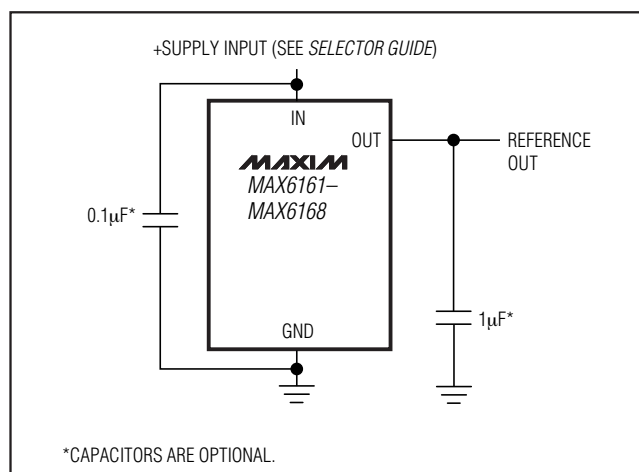

Chip Information

TRANSISTOR COUNT: 117

PROCESS: BiCMOS

Precision, Micropower, Low-Dropout, High-Output-Current, SO-8 Voltage References

Selector Guide

| PART | OUTPUT VOLTAGE (V) | INITIAL ACCURACY (mV) | TEMPERATURE COEFFICIENT (ppm/°C) |
|----------|--------------------|-----------------------|----------------------------------|
| MAX6161A | 1.250 | ±2 | 10 |
| MAX6161B | 1.250 | ±4 | 15 |
| MAX6168A | 1.800 | ±2 | 5 |
| MAX6168B | 1.800 | ±5 | 10 |
| MAX6162A | 2.048 | ±2 | 5 |
| MAX6162B | 2.048 | ±5 | 10 |
| MAX6166A | 2.500 | ±2 | 5 |
| MAX6166B | 2.500 | ±5 | 10 |
| MAX6163A | 3.000 | ±2 | 5 |
| MAX6163B | 3.000 | ±5 | 10 |
| MAX6164A | 4.096 | ±2 | 5 |
| MAX6164B | 4.096 | ±5 | 10 |
| MAX6167A | 4.500 | ±2 | 5 |
| MAX6167B | 4.500 | ±5 | 10 |
| MAX6165A | 5.000 | ±2 | 5 |
| MAX6165B | 5.000 | ±5 | 10 |

MAX6161-MAX6168

Precision, Micropower, Low-Dropout, High-Output-Current, SO-8 Voltage References

Package Information

(The package drawing(s) in this data sheet may not reflect the most current specifications. For the latest package outline information go to www.maxim-ic.com/packages.)

MAX6161-MAX6168

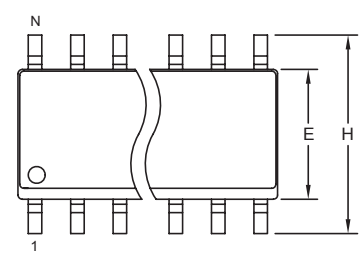

TOP VIEW

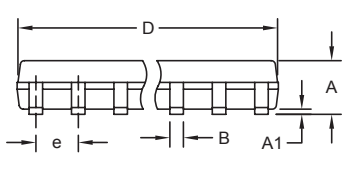

FRONT VIEW

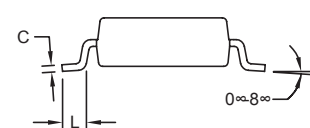

SIDE VIEW

NOTES:

1. D&E DO NOT INCLUDE MOLD FLASH.
2. MOLD FLASH OR PROTRUSIONS NOT TO EXCEED 0.15mm (.006").
3. LEADS TO BE COPLANAR WITHIN 0.10mm (.004").
4. CONTROLLING DIMENSION: MILLIMETERS.
5. MEETS JEDEC MS012.
6. N = NUMBER OF PINS.

| DIM | INCHES | | MILLIMETERS | |
|-----|-----------|-------|-------------|------|
| | MIN | MAX | MIN | MAX |
| A | 0.053 | 0.069 | 1.35 | 1.75 |
| A1 | 0.004 | 0.010 | 0.10 | 0.25 |
| B | 0.014 | 0.019 | 0.35 | 0.49 |
| C | 0.007 | 0.010 | 0.19 | 0.25 |
| e | 0.050 BSC | | 1.27 BSC | |
| E | 0.150 | 0.157 | 3.80 | 4.00 |
| H | 0.228 | 0.244 | 5.80 | 6.20 |
| L | 0.016 | 0.050 | 0.40 | 1.27 |

VARIATIONS:

| DIM | INCHES | | MILLIMETERS | | N | MS012 |
|-----|--------|-------|-------------|-------|----|-------|
| | MIN | MAX | MIN | MAX | | |
| D | 0.189 | 0.197 | 4.80 | 5.00 | 8 | AA |
| D | 0.337 | 0.344 | 8.55 | 8.75 | 14 | AB |
| D | 0.386 | 0.394 | 9.80 | 10.00 | 16 | AC |



PROPRIETARY INFORMATION

TITLE: PACKAGE OUTLINE, .150" SOIC

| | | | |
|----------|---------------------------------|-----------|-----|
| APPROVAL | DOCUMENT CONTROL NO. 21-0041 | REV. B | 1/1 |
|----------|---------------------------------|-----------|-----|

Maxim cannot assume responsibility for use of any circuitry other than circuitry entirely embodied in a Maxim product. No circuit patent licenses are implied. Maxim reserves the right to change the circuitry and specifications without notice at any time.

Maxim Integrated Products, 120 San Gabriel Drive, Sunnyvale, CA 94086 408-737-7600 _____ 17