



Chipsmall Limited consists of a professional team with an average of over 10 year of expertise in the distribution of electronic components. Based in Hongkong, we have already established firm and mutual-benefit business relationships with customers from,Europe,America and south Asia,supplying obsolete and hard-to-find components to meet their specific needs.

With the principle of “Quality Parts,Customers Priority,Honest Operation,and Considerate Service”,our business mainly focus on the distribution of electronic components. Line cards we deal with include Microchip,ALPS,ROHM,Xilinx,Pulse,ON,Everlight and Freescale. Main products comprise IC,Modules,Potentiometer,IC Socket,Relay,Connector.Our parts cover such applications as commercial,industrial, and automotives areas.

We are looking forward to setting up business relationship with you and hope to provide you with the best service and solution. Let us make a better world for our industry!



Contact us

Tel: +86-755-8981 8866 Fax: +86-755-8427 6832

Email & Skype: info@chipsmall.com Web: www.chipsmall.com

Address: A1208, Overseas Decoration Building, #122 Zhenhua RD., Futian, Shenzhen, China



MAXIM

MAX8537 Evaluation Kit

Evaluates: MAX8537

General Description

The MAX8537 evaluation kit (EV kit) is a fully assembled and tested circuit board that demonstrates the MAX8537 dual, out-of-phase, PWM synchronous buck controller. The EV kit is a complete power-management solution for a double-data-rate (DDR) memory supply. It generates the main memory voltage (V_{DDQ}), the tracking sinking/sourcing termination voltage (V_{TT}), and the reference voltage (V_{TTR}). The EV kit takes a 12V input voltage and converts the voltage down to 2.5V for the V_{DDQ} supply, 1.25V for the V_{TT} supply, and 1.25V for the V_{TTR} reference. The 2.5V (V_{DDQ}) supply is capable of sourcing 20A, the 1.25V (V_{TT}) supply is capable of sinking/sourcing 8A, and V_{TTR} is capable of sinking/sourcing 15mA.

Features

- ◆ Complete DDR Supplies: V_{DDQ} , V_{TT} , and V_{TTR}
- ◆ Out-of-Phase Operation
- ◆ 90% Efficiency
- ◆ 400kHz Switching Frequency
- ◆ Independent POK_ and EN_ for Flexible Sequencing
- ◆ Adjustable Soft-Start and Soft-Stop for Each Output
- ◆ Lossless Adjustable Hiccup Current Limit
- ◆ Output Overvoltage Protection
- ◆ 28-Pin QSOP Package
- ◆ Fully Assembled and Tested

Ordering Information

PART	TEMP RANGE	IC PACKAGE
MAX8537EVKIT	0°C to +70°C	28 QSOP

Component List

DESIGNATION	QTY	DESCRIPTION
C1, C3, C26, C28, C29	5	1000 μ F \pm 20%, 25V, 12.5mm x 20mm, aluminum electrolytic capacitors Panasonic EEUF1E102B Sanyo 25MV1000AX
C2, C4	2	10 μ F \pm 20%, 25V X5R (1210) ceramic capacitors Taiyo Yuden TMK325BJ106MM
C5, C6	2	0.47 μ F \pm 10%, 10V X5R (0603) ceramic capacitors Taiyo Yuden LMK107BJ474KA TDK C1608X5R1A474K
C7, C10, C23, C24	4	0.01 μ F \pm 20%, 50V X7R (0603) ceramic capacitors Kemet C0603C103M5RAC Taiyo Yuden UMK107B103MZ TDK C1608X7R1H103K
C8, C9, C35, C41	0	Not installed (0603)
C11, C30, C31, C32	4	680 μ F, 2.5V, 6m Ω , D4-size POSCAPs Sanyo 2R5TPD680M6
C12, C36	2	220 μ F, 4V, 5m Ω , E-size SP-caps Panasonic EEFSE0G221R

DESIGNATION	QTY	DESCRIPTION
C13	1	10 μ F \pm 20%, 6.3V X5R (0805) ceramic capacitor Taiyo Yuden JMK212BJ106MG TDK C2012X5R0J106M
C14	1	1 μ F \pm 10%, 25V X7R (1206) ceramic capacitor Kemet C1206C105K3RAC Murata GRM31MR71E105K TDK C3216X7R1E105K
C15	1	1 μ F \pm 10%, 10V X5R (0603) ceramic capacitor Murata GRM188R61A105K TDK C1608X5R1A105K
C16	1	1 μ F \pm 10%, 16V X7R (0805) ceramic capacitor Kemet C0805C105K4RAC Murata GRM21BR71C105K TDK C2012X7R1C105K
C17, C19, C39, C42	4	1500pF \pm 20%, 25V X7R (0603) ceramic capacitors Kemet C0603C152M3RAC

MAX8537 Evaluation Kit

Evaluates: MAX8537

Component List (continued)

DESIGNATION	QTY	DESCRIPTION
C18	1	6.8pF ±5%, 50V C0G (0603) ceramic capacitor Kemet C0603C689M5GAC
C20	1	39pF ±5%, 50V C0G (0603) ceramic capacitor Kemet C0603C390M5GAC TDK C1608C0G1H390J
C21	1	3900pF ±20%, 10V X7R (0603) ceramic capacitor Kemet C0603C392M8RAC
C22	1	820pF ±20%, 10V X7R (0603) ceramic capacitor Kemet C0603C821M8RAC
C25	1	220pF ±5%, 50V C0G (0603) ceramic capacitor Kemet C0603C221J5GAC Murata GRM1885C1H221J TDK C1608C0G1H221J
C27	0	Not installed, 12.5mm x 20mm
C33, C34, C37, C38	0	Not installed, E-size
C40	1	2200pF ±20%, 25V X7R (0603) ceramic capacitor Kemet C0603C222M3RAC
D1, D2	2	Schottky diode, 0.1A, 30V SOD-323 Central Semiconductor CMDSH-3 (top mark = S1)
JU1–JU4	4	3-pin headers, 0.1in center
JU5, JU6, JU7	0	Not installed, 2-pin headers, 0.1in center
L1	1	0.9μH, 25A, 1.15mΩ inductor BI Technologies HM73-40R90 TOKO FDH1065-R91M
L2	1	0.8μH, 16A, 2.33mΩ inductor Panasonic ETQP3H0R8BFA
N1	1	MOSFET, n-channel, 30V, 8.3A, 17mΩ, SO-8 International Rectifier IRF7807V
N2, N5	0	Not installed, SO8
N3, N4, N6	3	MOSFETs, n-channel, 30V, 13.6A, 9.5mΩ, SO-8 International Rectifier IRF7821
N7, N8	2	MOSFETs, n-channel, 30V, 20A, 4.8mΩ, SO-8 International Rectifier IRF7832
Q1	0	Not installed, SOT223 Fairchild PZT3906
R1	0	Not installed (2512)
R2	1	1.69kΩ ±1% (0603) resistor

DESIGNATION	QTY	DESCRIPTION
R3	1	1.05kΩ ±1% (0603) resistor
R4	0	Not installed (2512)
R5, R6, R19, R20	4	100kΩ ±5% (0603) resistors
R7	1	2.2Ω ±5% (0603) resistor
R8	1	4.7Ω ±5% (0603) resistor
R9	1	51.1kΩ ±1% (0603) resistor
R10	1	30.1kΩ ±1% (0603) resistor
R11	1	110kΩ ±5% (0603) resistor
R12	1	2.7kΩ ±5% (0603) resistor
R13	1	1.2kΩ ±5% (0603) resistor
R14	1	22kΩ ±5% (0603) resistor
R15	1	21.5kΩ ±1% (0603) resistor
R16, R17, R18	3	10kΩ ±1% (0603) resistors
R21, R26	2	4.7Ω ±5% (1206) resistors
R22	1	2.0Ω ±5% (1206) resistor
R23, R24, R25, R31, R32	0	Not installed (0603)
R27, R28	2	1.0Ω ±5% (0603) resistors
R29, R30	2	0.0Ω ±5% (0603) resistors

Quick Start

Recommended Equipment

Before beginning, the following equipment is recommended:

- 12V, 10A DC power supply
- Three voltmeters

Procedure

The MAX8537 EV kit is a fully assembled and tested surface-mount board. Follow the steps below to verify board operation. **Do not turn on the power supply until all connections are completed:**

- 1) Set jumper JU1 to position 1-2.
- 2) Set jumper JU2 to position 1-2.
- 3) Set jumper JU3 to position 1-2 to enable VOUT2.
- 4) Set jumper JU4 to position 1-2 to enable VOUT1.
- 5) Connect the 12V supply across the VIN and PGND pads.
- 6) Connect a voltmeter across the VOUT1 and PGND pads.
- 7) Connect a voltmeter across the VOUT2 and PGND pads.
- 8) Connect a voltmeter across the VTTR and AGND pads.

MAX8537 Evaluation Kit

Evaluates: MAX8537

Table 1. Jumpers Selection

JUMPER	JUMPER POSITION	FUNCTION
JU1	1-2*	Output Current-Limit Setting for VOUT2. Connects ILIM2 to the drain of the high-side MOSFET (N1/N2) for lossless sensing.
	2-3	Connects ILIM2 to the current-sense resistor (R1) for more accurate sensing.
JU2	1-2*	Output Current-Limit Setting for VOUT1. Connects ILIM1 to the drain of the high-side MOSFET (N3/N4) for lossless sensing.
	2-3	Connects ILIM1 to the current-sense resistor (R4) for more accurate sensing.
JU3	1-2*	Enables VOUT2.
	2-3	Disables VOUT2.
	Open	Drive pad EN2 with an external logic signal.
JU4	1-2*	Enables VOUT1.
	2-3	Disables VOUT1.
	Open	Drive pad EN1 with an external logic signal.

*Default position.

- 9) Turn on the power supply.
- 10) Verify that the VOUT1 voltage is 2.5V.
- 11) Verify that the VOUT2 voltage is 1.25V.
- 12) Verify that the V_{TTR} voltage is 1.25V.

Detailed Description

The MAX8537 EV kit demonstrates the MAX8537 dual, out-of-phase, PWM synchronous buck controller. The EV kit is a complete power-management solution for a DDR supply. It generates the main memory voltage (V_{DDQ}), the tracking sinking/sourcing termination voltage (V_{TT}), and the reference voltage (V_{TTR}).

The EV kit takes a 12V input voltage and converts the voltage down to 2.5V for the V_{DDQ} supply, 1.25V for the V_{TT} supply, and 1.25V for the V_{TTR} reference. The 2.5V (V_{DDQ}) supply is capable of sourcing 20A, the 1.25V (V_{TT}) supply is capable of sinking/sourcing 8A, and V_{TTR} is capable of sinking/sourcing 15mA.

Output-Voltage Setting (VOUT1 and VOUT2)

The resistor-divider formed by R15 and R16 sets VOUT1. The MAX8537 EV kit is shipped with the divider set so VOUT1 equals 2.5V. Change the voltage by selecting R16, the resistor from FB1 to GND, between 5kΩ and 15kΩ. Then calculate R15 by:

$$R15 = R16 \times [(VOUT1 / 0.8) - 1]$$

The resistor-divider formed by R10 and R23 sets VOUT2. The MAX8537 EV kit is shipped with the divider set so VOUT2 equals 1.25V. Change the voltage by

selecting R23, the resistor from FB2 to GND, between 5kΩ and 15kΩ. Then calculate R10 by:

$$R10 = R23 \times [(VOUT2 / REFIN) - 1]$$

Note: REFIN is set to 1/2 x VOUT1 by resistor-divider R17/R18.

Note: When changing output voltages, it may be necessary to choose new inductor and capacitor values. Refer to the *Inductor Selection* and *Output Capacitor* sections of the MAX8537/MAX8538/MAX8539 data sheet for more information.

Current Limits (ILIM1 and ILIM2)

The MAX8537 senses the peak inductor current either through the on-resistance of the high-side MOSFET for lossless sensing or with a series resistor for more accurate sensing. Jumper JU1, position 1-2, connects ILIM2 to the drain of the high-side MOSFET for lossless sensing; position 2-3 connects ILIM2 to the current-sense resistor (R1) for more accurate sensing. Jumper JU2, position 1-2, connects ILIM1 to the drain of the high-side MOSFET for lossless sensing; position 2-3 connects ILIM1 to the current-sense resistor (R4) for more accurate sensing.

The MAX8537 is set up for lossless current sensing. To use current-sense resistors, cut the shorts across R1 and R4 and remove R29, R30, C7, and C10. Install R1, R4, R24, R25, R31, R32, C8, C9, C35, and C41. Use R29 and R30 for R31 and R32. Connect jumpers JU1 and JU2 in the 2-3 positions. Refer to the *Current Limit* section of the MAX8537/MAX8538/MAX8539 data sheet for more information.

MAX8537 Evaluation Kit

Component Suppliers

SUPPLIER	PHONE	FAX	WEBSITE
BI Technologies	714-447-2300	714-447-2400	www.bitechnologies.com
Central Semiconductor	631-435-1110	631-435-1824	www.centalsemi.com
International Rectifier (IRF)	310-322-3331	310-726-8721	www.irf.com
Kemet	864-963-6300	864-963-6322	www.kemet.com
Murata	770-436-1300	770-436-3030	www.murata.com
Panasonic	714-373-7366	714-737-7323	www.panasonic.com
Sanyo	619-661-6835	619-661-1055	www.sanyo.com
Taiyo Yuden	800-348-2496	847-925-0899	www.t-yuden.com
TDK	847-803-6100	847-390-4405	www.component.tdk.com
TOKO	847-297-0070	847-699-1194	www.tokoam.com

Note: Indicate you are using the MAX8537 when contacting these component suppliers.

Output Enables (EN1 and EN2)

Outputs of the MAX8537 can be turned on and off independently at EN1 and EN2. Jumper JU3, position 1-2, pulls EN2 high to turn on VOUT2; position 2-3 pulls EN2 low to turn off VOUT2. Jumper JU4, position 1-2, pulls EN1 high to turn on VOUT1; position 2-3 pulls EN1 low to turn off VOUT1.

MAX8537 Evaluation Kit

Evaluates: MAX8537

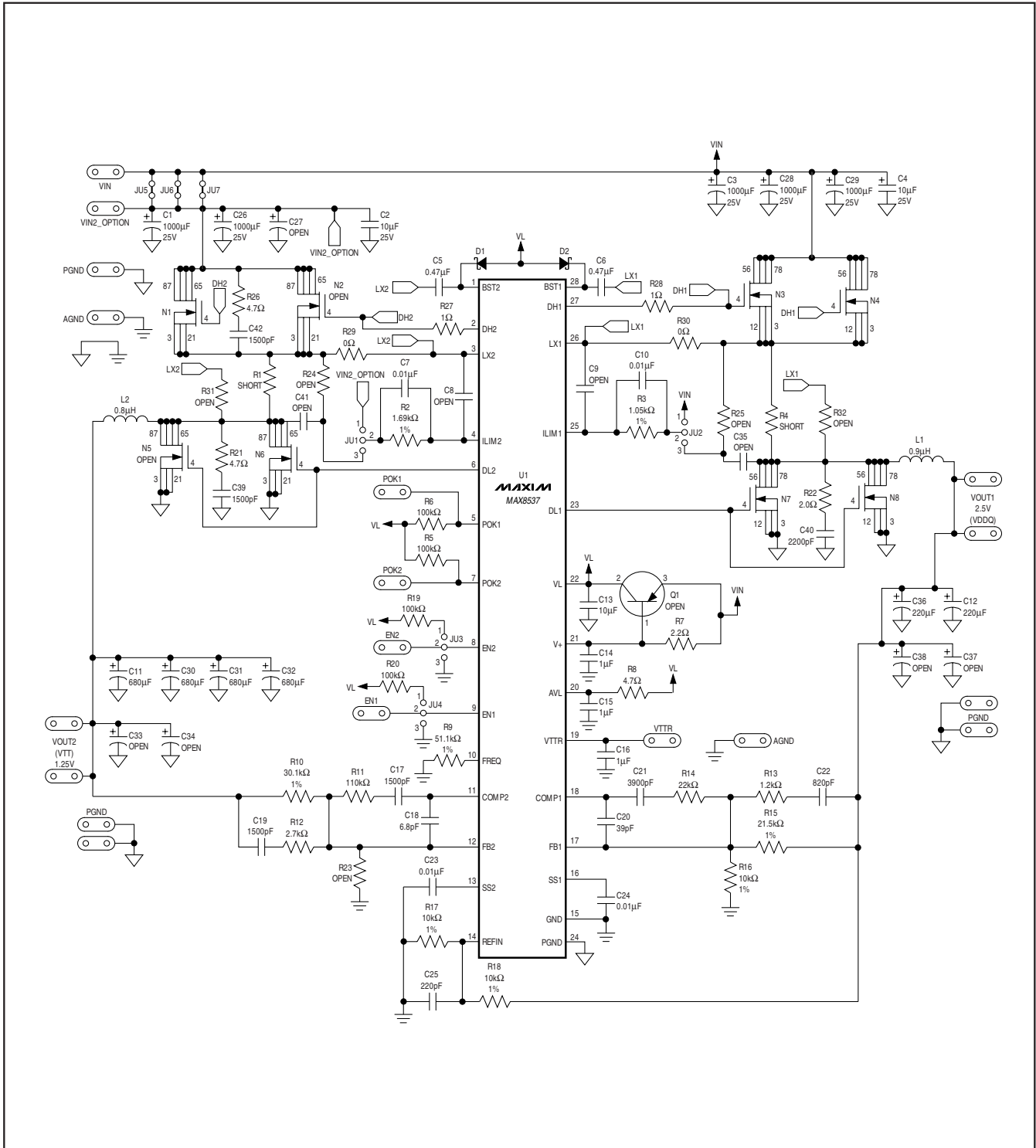

Figure 1. MAX8537 EV Kit Schematic

MAX8537 Evaluation Kit

Evaluates: MAX8537

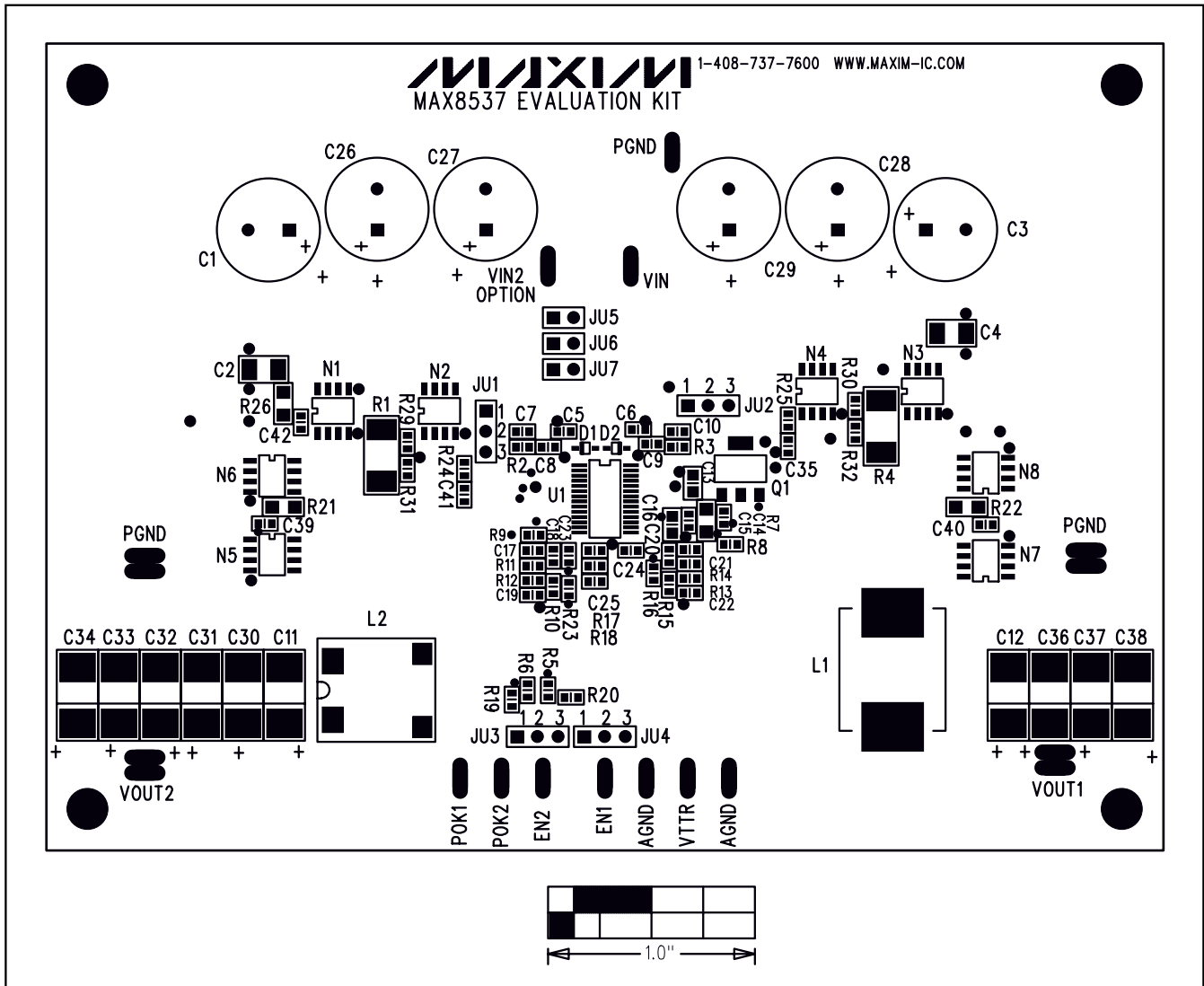

Figure 2. MAX8537 EV Kit Component Placement Guide—Component Side

MAX8537 Evaluation Kit

Evaluates: MAX8537

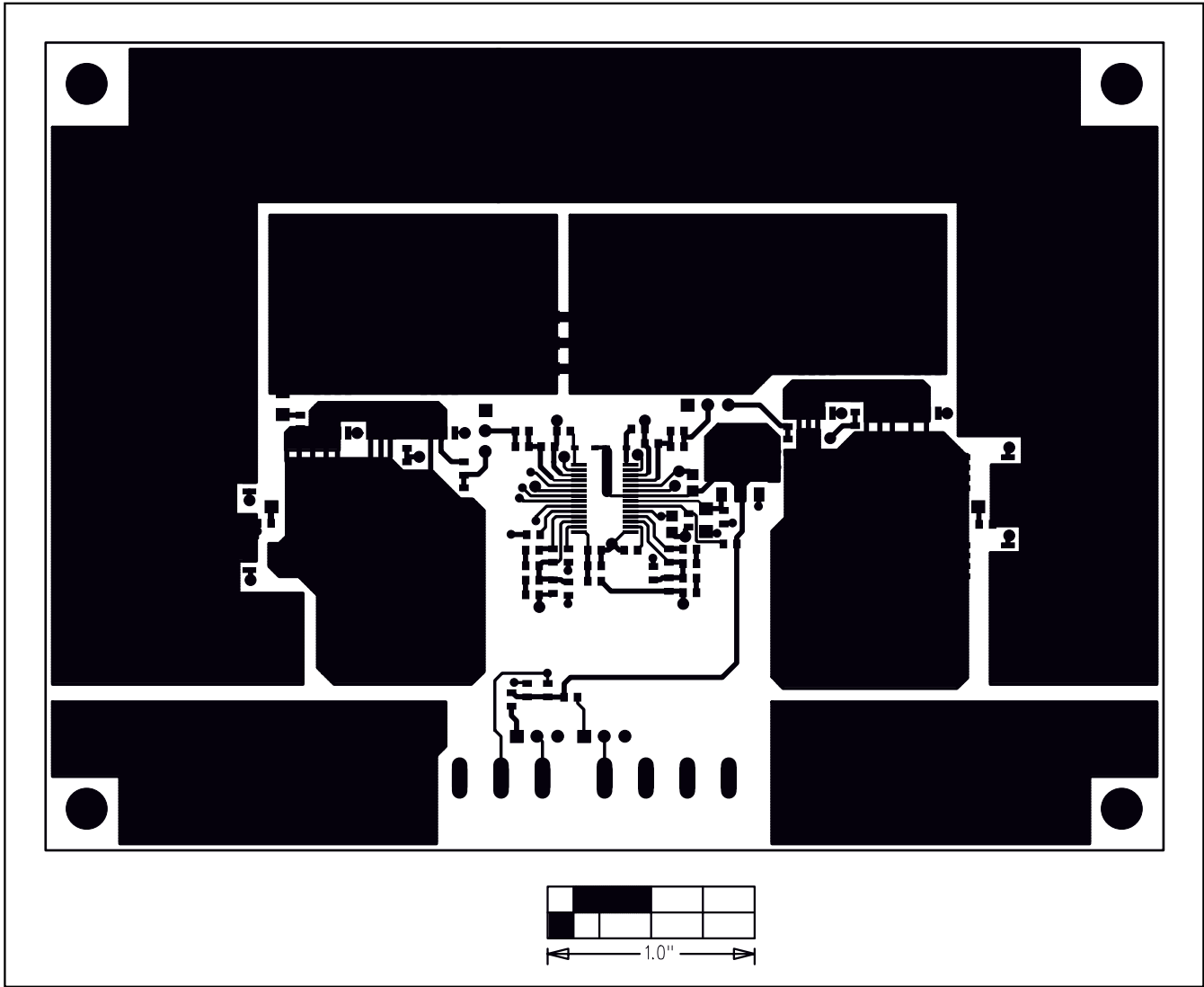

Figure 3. MAX8537 EV Kit PC Board Layout—Component Side

MAX8537 Evaluation Kit

Evaluates: MAX8537

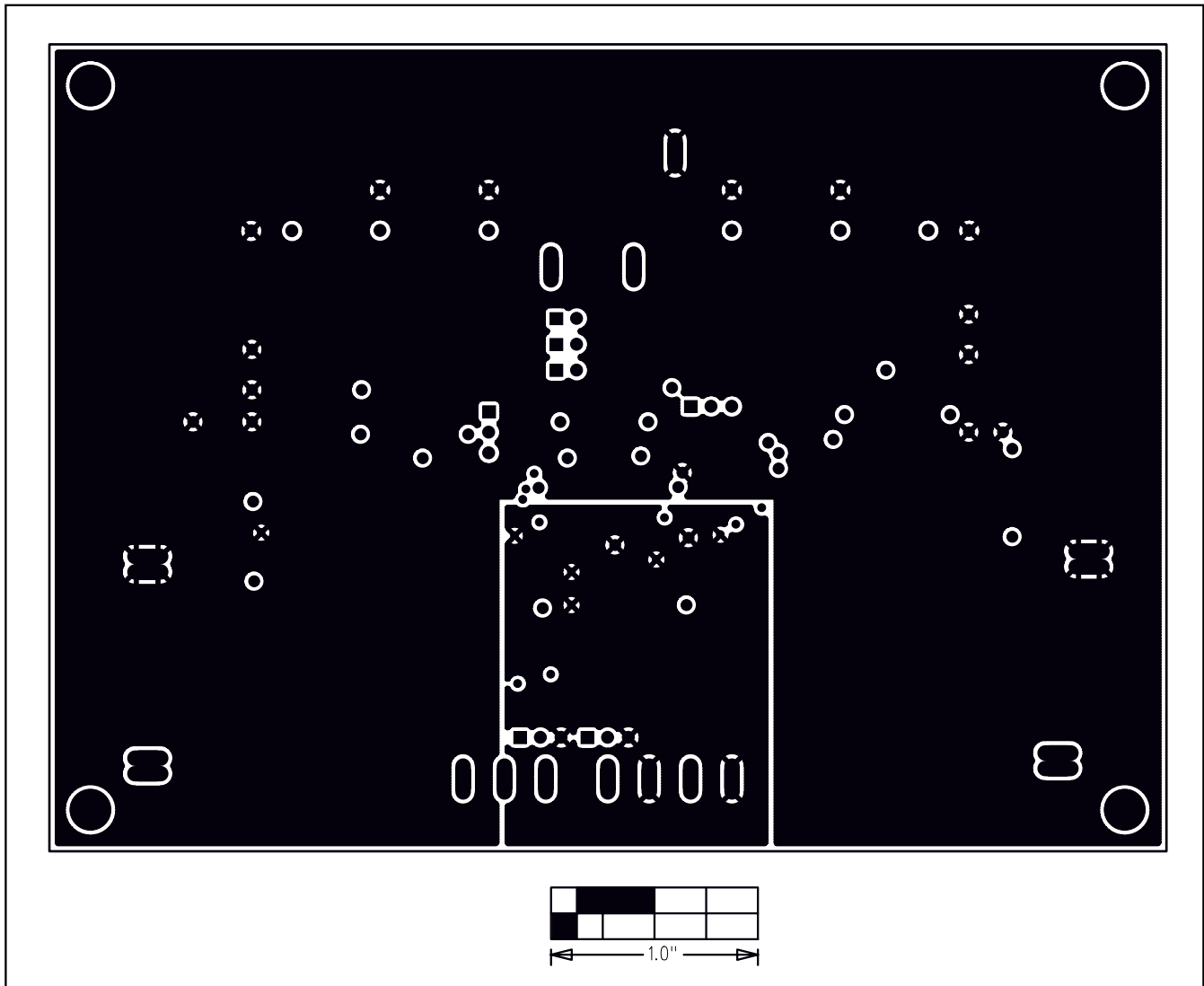

Figure 4. MAX8537 EV Kit PC Board Layout—GND Layer

MAX8537 Evaluation Kit

Evaluates: MAX8537

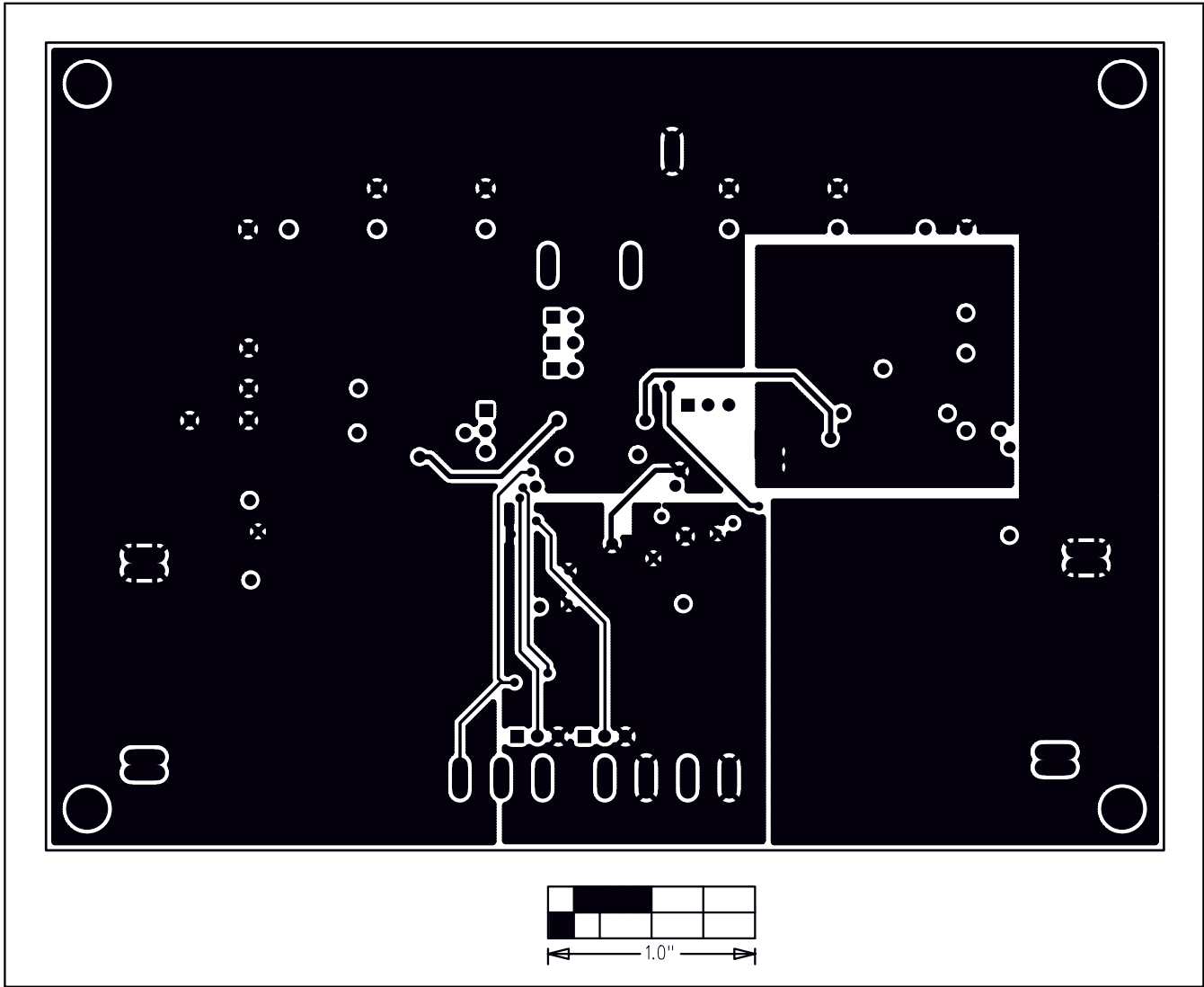

Figure 5. MAX8537 EV Kit PC Board Layout—PGND Layer

MAX8537 Evaluation Kit

Evaluates: MAX8537

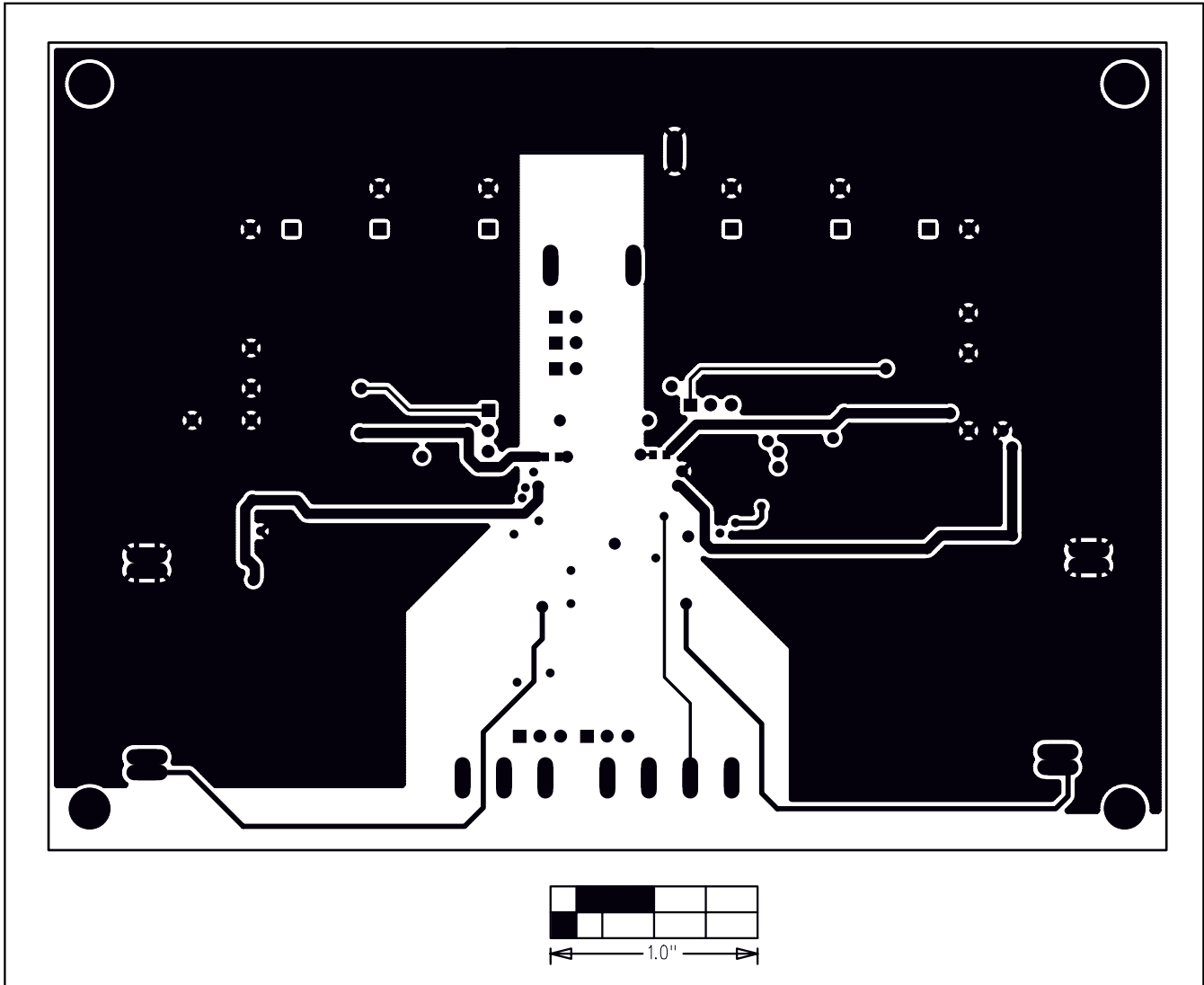

Figure 6. MAX8537 EV Kit PC Board Layout—Solder Side

MAX8537 Evaluation Kit

Evaluates: MAX8537

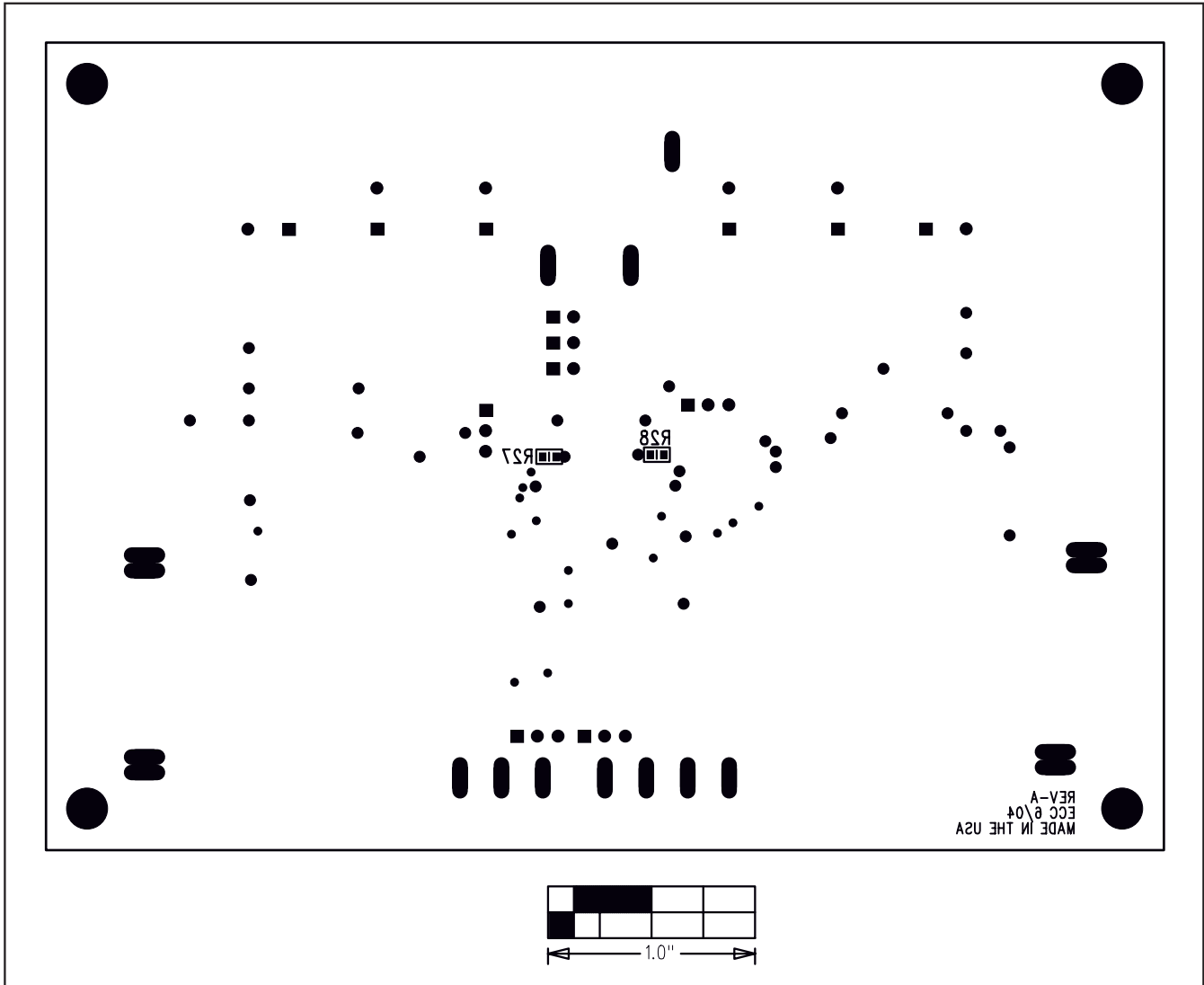

Figure 7. MAX8537 EV Kit Component Placement Guide—Solder Side

Maxim cannot assume responsibility for use of any circuitry other than circuitry entirely embodied in a Maxim product. No circuit patent licenses are implied. Maxim reserves the right to change the circuitry and specifications without notice at any time.

Maxim Integrated Products, 120 San Gabriel Drive, Sunnyvale, CA 94086 408-737-7600 _____ 11