



Chipsmall Limited consists of a professional team with an average of over 10 year of expertise in the distribution of electronic components. Based in Hongkong, we have already established firm and mutual-benefit business relationships with customers from,Europe,America and south Asia,supplying obsolete and hard-to-find components to meet their specific needs.

With the principle of “Quality Parts,Customers Priority,Honest Operation,and Considerate Service”,our business mainly focus on the distribution of electronic components. Line cards we deal with include Microchip,ALPS,ROHM,Xilinx,Pulse,ON,Everlight and Freescale. Main products comprise IC,Modules,Potentiometer,IC Socket,Relay,Connector.Our parts cover such applications as commercial,industrial, and automotives areas.

We are looking forward to setting up business relationship with you and hope to provide you with the best service and solution. Let us make a better world for our industry!



Contact us

Tel: +86-755-8981 8866 Fax: +86-755-8427 6832

Email & Skype: info@chipsmall.com Web: www.chipsmall.com

Address: A1208, Overseas Decoration Building, #122 Zhenhua RD., Futian, Shenzhen, China





High-Efficiency, Low-IQ PMIC with Dynamic Core for PDAs and Smartphones

MAX8588

General Description

The MAX8588 power-management IC is optimized for devices using Intel X-Scale™ microprocessors, including smartphones, PDAs, internet appliances, and other portable devices requiring substantial computing and multimedia capability at low power.

The IC integrates seven high-performance, low-operating-current power supplies along with supervisory and management functions. Included are three step-down DC-DC outputs, three linear regulators, and a seventh always-on output. DC-DC converters power I/O, memory, and the CPU core. The I/O supply can be preset to 3.3V or adjusted to other values. The DRAM supply is preset for 3.3V or 2.5V, or it can be adjusted with external resistors. The CPU core supply is serial programmed for dynamic voltage management and can supply up to 0.5A. Linear-regulated outputs are provided for SRAM, PLL, and USIM supplies.

To minimize quiescent current, critical power supplies have bypass “sleep” LDOs that can be activated when output current is very low. Other functions include separate on/off control for all DC-DC converters, low-battery and dead-battery detection, a reset and power-OK output, a backup-battery input, and a two-wire serial interface.

All DC-DC outputs use fast, 1MHz PWM switching and small external components. They operate with fixed-frequency PWM control and automatically switch from PWM to skip-mode operation at light loads to reduce operating current and extend battery life. The core output can be forced into PWM mode at all loads to minimize noise. A 2.6V to 5.5V input voltage range allows 1-cell lithium-ion (Li+), 3-cell NiMH, or a regulated 5V input. The MAX8588 is available in a tiny 6mm x 6mm, 48-pin thin QFN package.

Applications

PDA, Palmtop, and Wireless Handhelds
Third-Generation Smart Cell Phones
Internet Appliances and Web-Books

X-Scale is a trademark of Intel Corp.



Features

- ◆ **Six Regulators in One Package**
 - Step-Down DC-DC for I/O at 1.3A
 - Step-Down DC-DC for Memory at 0.9A
 - Step-Down Serial-Programmed DC-DC for CORE Up to 0.5A
 - Three LDO Outputs for SRAM, PLL, and USIM
 - Always-On Output for VCC_BATT
- ◆ **Low Operating Current**
 - 60µA in Sleep Mode (Sleep LDOs On)
 - 130µA with DC-DCs On (Core Off)
 - 200µA All Regulators On, No Load
 - 5µA Shutdown Current
- ◆ **Optimized for X-Scale Processors**
- ◆ **Backup-Battery Input**
- ◆ **1MHz PWM Switching Allows Small External Components**
- ◆ **Tiny 6mm x 6mm, 48-Pin Thin QFN Package**

Ordering Information

PART	TEMP RANGE	PIN-PACKAGE
MAX8588ETM	-40°C to +85°C	48 Thin QFN (6mm x 6mm)

Pin Configuration appears at end of data sheet.

Simplified Diagram

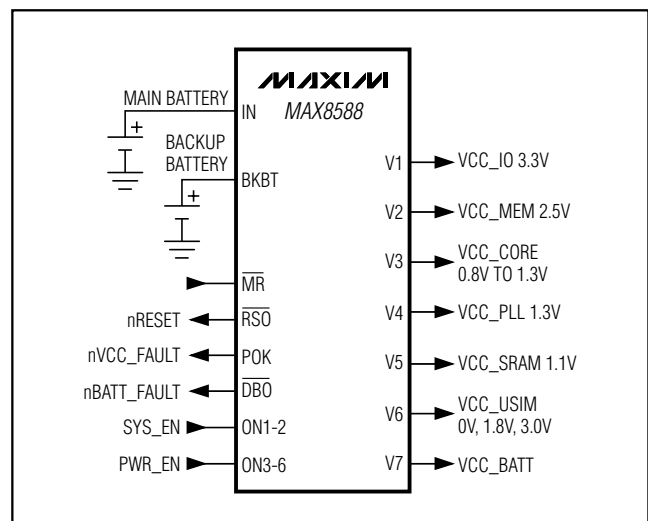

High-Efficiency, Low-Iq PMIC with Dynamic Core for PDAs and Smartphones

ABSOLUTE MAXIMUM RATINGS

IN, IN45, IN6, MR, LBO, DBO, RSO, POK, SCL, SDA, BKBT, V7, SLP, SRAD, PWM3 to GND	-0.3V to +6V
REF, CC-, ON-, FB-, DBI, LBI, V1, V2, RAMP, BYP, MR to GND	-0.3V to (VIN + 0.3V)
PV1, PV2, PV3, SLPIN to IN	-0.3V to +0.3V
V4, V5 to GND	-0.3V to (VIN45 + 0.3V)
V6 to GND	-0.3V to (VIN6 + 0.3V)
PV1 to PG1	-0.3V to +6.0V
PV2 to PG2	-0.3V to +6.0V
PV3 to PG3	-0.3V to +6.0V
LX1 Continuous Current	-1.30A to +1.30A

LX2 Continuous Current	-0.9A to +0.9A
LX3 Continuous Current	-0.5A to +0.5A
PG1, PG2, PG3 to GND	-0.3V to +0.3V
V1, V2, V4, V5, V6 Output Short-Circuit Duration	Continuous
Continuous Power Dissipation (TA = +70°C) 6mm x 6mm 48-Pin Thin QFN (derate 26.3mW/°C above +70°C)	2105mW
Operating Temperature Range	-40°C to +85°C
Junction Temperature	+150°C
Storage Temperature Range	-65°C to +150°C
Lead Temperature (soldering, 10s)	+300°C

Stresses beyond those listed under "Absolute Maximum Ratings" may cause permanent damage to the device. These are stress ratings only, and functional operation of the device at these or any other conditions beyond those indicated in the operational sections of the specifications is not implied. Exposure to absolute maximum rating conditions for extended periods may affect device reliability.

ELECTRICAL CHARACTERISTICS

(VIN = 3.6V, VBKBT = 3.0V, VLBI = 1.1V, VDBI = 1.35V, circuit of Figure 5, TA = 0°C to +85°C, unless otherwise noted. Typical values are at TA = +25°C.)

PARAMETER	CONDITIONS	MIN	TYP	MAX	UNITS	
PV1, PV2, PV3, SLPIN, IN Supply Voltage Range	PV1, PV2, PV3, IN, and SLPIN must connect together externally	2.6		5.5	V	
IN45, IN6 Supply Voltage Range		2.4		5.5	V	
IN Undervoltage-Lockout (UVLO) Threshold	VIN rising	2.25	2.40	2.55	V	
	VIN falling	2.200	2.35	2.525		
Quiescent Current	No load (IPV1 + IPV2 + IPV3 + IIN + ISLPIN + IIN45 + IIN6) Only V7 on, VIN = 3.0V	32			μA	
		REG1 and REG2 on in switch mode, REG3 off				130
		REG1 and REG2 on in sleep mode, REG3 off				60
		All REGs on				225
BKBT Input Current	ON1 = 0	4			μA	
	ON1 = IN	0.8				
REF Output Voltage	0 to 10μA load	1.2375	1.25	1.2625	V	
SYNCHRONOUS-BUCK PWM REG1						
REG1 Voltage Accuracy	FB1 = GND, 3.6V ≤ VPV1 ≤ 5.5V, load = 0 to 1300mA	3.25	3.3	3.35	V	
FB1 Voltage Accuracy	FB1 used with external resistors, 3.6V ≤ VPV1 ≤ 5.5V, load = 0 to 1300mA	1.231	1.25	1.269	V	
FB1 Input Current	FB1 used with external resistors	100			nA	
Error-Amplifier Transconductance	Referred to FB	87			μS	
Dropout Voltage (Note 1)	Load = 800mA	180 280			mV	
	Load = 1300mA	293 450				

High-Efficiency, Low-Iq PMIC with Dynamic Core for PDAs and Smartphones

MAX8588

ELECTRICAL CHARACTERISTICS (continued)

($V_{IN} = 3.6V$, $V_{BKBT} = 3.0V$, $V_{LBI} = 1.1V$, $V_{DBI} = 1.35V$, circuit of Figure 5, $T_A = 0^{\circ}C$ to $+85^{\circ}C$, unless otherwise noted. Typical values are at $T_A = +25^{\circ}C$.)

PARAMETER	CONDITIONS	MIN	TYP	MAX	UNITS
p-Channel On-Resistance	$I_{LX1} = -180mA$		0.18	0.3	Ω
	$I_{LX1} = -180mA$, $V_{PV1} = 2.6V$		0.21	0.35	
n-Channel On-Resistance	$I_{LX1} = 180mA$		0.13	0.225	Ω
	$I_{LX1} = 180mA$, $V_{PV1} = 2.6V$		0.15	0.25	
Current-Sense Transresistance			0.5		V/A
p-Channel Current-Limit Threshold		-1.55	-1.80	-2.10	A
PWM Skip-Mode Transition Load Current	Decreasing load current (Note 2)		30		mA
OUT1 Maximum Output Current	$2.6V \leq V_{PV1} \leq 5.5V$ (Note 3)	1.3			A
LX1 Leakage Current	$V_{PV1} = 5.5V$, $LX1 = GND$ or $PV1$, $V_{ON1} = 0V$	-20	+0.1	+20	μA
SYNCHRONOUS-BUCK PWM REG2					
REG2 Voltage Accuracy	$FB2 = GND$, $3.6V \leq V_{PV2} \leq 5.5V$, load = 0 to 900mA	2.463	2.5	2.537	V
	$FB2 = IN$, $3.6V \leq V_{PV2} \leq 5.5V$, load = 0 to 900mA	3.25	3.3	3.35	
FB2 Voltage Accuracy	FB2 used with external resistors, $3.6V \leq V_{PV2} \leq 5.5V$, load = 0 to 900mA	1.231	1.25	1.269	V
FB2 Input Current	FB2 used with external resistors, $V_{FB2} = 1.25V$			100	nA
Error-Amplifier Transconductance	Referred to FB		87		μS
Dropout Voltage	Load = 900mA (Note 1)		243	380	mV
p-Channel On-Resistance	$I_{LX2} = -180mA$		0.225	0.375	Ω
	$I_{LX2} = -180mA$, $V_{PV2} = 2.6V$		0.26	0.425	
n-Channel On-Resistance	$I_{LX2} = 180mA$		0.15	0.25	Ω
	$I_{LX2} = 180mA$, $V_{PV2} = 2.6V$		0.17	0.275	
Current-Sense Transresistance			0.7		V/A
p-Channel Current-Limit Threshold		-1.10	-1.275	-1.50	A
PWM Skip-Mode Transition Load Current	Decreasing load current (Note 2)		30		mA
OUT2 Maximum Output Current	$2.6V \leq V_{PV2} \leq 5.5V$ (Note 3)	0.9			A
LX2 Leakage Current	$V_{PV2} = 5.5V$, $LX2 = GND$ or $PV2$, $V_{ON2} = 0V$	-10	+0.1	+10	μA
SYNCHRONOUS-BUCK PWM REG3					
REG3 Voltage Accuracy	REG3 from 0.7V to 1.475V, $2.6V \leq V_{PV3} \leq 5.5V$	Load = 0 to 500mA	-1.5	+1.5	%
Error-Amplifier Transconductance			68		μS

High-Efficiency, Low-I_q PMIC with Dynamic Core for PDAs and Smartphones

ELECTRICAL CHARACTERISTICS (continued)

(V_{IN} = 3.6V, V_{BKBT} = 3.0V, V_{LBI} = 1.1V, V_{DBI} = 1.35V, circuit of Figure 5, T_A = 0°C to +85°C, unless otherwise noted. Typical values are at T_A = +25°C.)

PARAMETER	CONDITIONS	MIN	TYP	MAX	UNITS
p-Channel On-Resistance	I _{LX3} = -180mA		0.225	0.375	Ω
	I _{LX2} = -180mA, V _{pv3} = 2.6V		0.26	0.425	
n-Channel On-Resistance	I _{LX3} = 180mA		0.15	0.25	Ω
	I _{LX3} = 180mA, V _{pv3} = 2.6V		0.17	0.275	
Current-Sense Transresistance			1.1		V/A
p-Channel Current-Limit Threshold		-0.60	-0.7	-0.85	A
PWM Skip-Mode Transition Load Current	Decreasing load current (Note 2)		30		mA
OUT3 Maximum Output Current	2.6V ≤ V _{pv3} ≤ 5.5V (Note 3)	0.5			A
LX3 Leakage Current	V _{pv3} = 5.5V, LX3 = GND or PV2, V _{ON3} = 0V	-10	+0.1	+10	μA
LDOS V4, V5, V6, V1 SLEEP, V2 SLEEP, AND V7 OUTPUT					
V4, V5, V6, V1 SLEEP, V2 SLEEP Output Current		35			mA
V7 Output Current		30			mA
REG4 Output Voltage	Load = 0.1mA to 35mA	1.261	1.3	1.339	V
REG4 Noise	With 1μF C _{OUT} and 0.01μF C _{BYP}		15		μV _{RMS}
REG5 Output Voltage	Load = 0.1mA to 35mA	1.067	1.1	1.133	V
IN45, IN6 Input Voltage Range		2.4		5.5	V
REG6 Output Voltage (POR Default to 0V, Set by Serial Input)	0V setting (either ON6 low or serial programmed)		0		V
	1.8V setting, load = 0.1mA to 35mA	1.746	1.8	1.854	
	2.5V setting, load = 0.1mA to 35mA	2.425	2.5	2.575	
	3.0V setting, load = 0.1mA to 35mA	2.91	3.0	3.09	
V7 Output Voltage	V1 on and in regulation		V _{V1}		V
	V1 off		V _{BKBT}		
V1 and V2 SLEEP Output Voltage Accuracy	Set to same output voltage as REG1 and REG2	-3.0		+3.0	%
V1 and V2 SLEEP Dropout Voltage	Load = 20mA		75	150	mV
V6 Dropout Voltage	3V mode, load = 30mA, 2.5V mode, load = 30mA		110	200	mV
V7 Switch Voltage Drop	Load = 20mA, V _{BKBT} = V _{V1} = 3.0V		100	200	mV
V4, V5, V6 Output Current Limit		40	90		mA
BKBT Leakage				1	μA
OSCILLATOR					
PWM Switching Frequency		0.93	1	1.07	MHz
SUPERVISORY/MANAGEMENT FUNCTIONS					
POK Trip Threshold (Note 4)	Rising	92	94.75	97	%
	Falling	88.5	90.5	92.5	

High-Efficiency, Low-Iq PMIC with Dynamic Core for PDAs and Smartphones

MAX8588

ELECTRICAL CHARACTERISTICS (continued)

($V_{IN} = 3.6V$, $V_{BKBT} = 3.0V$, $V_{LBI} = 1.1V$, $V_{DBI} = 1.35V$, circuit of Figure 5, $T_A = 0^{\circ}C$ to $+85^{\circ}C$, unless otherwise noted. Typical values are at $T_A = +25^{\circ}C$.)

PARAMETER	CONDITIONS	MIN	TYP	MAX	UNITS	
LBI Threshold (Falling)	Hysteresis is 5% (typ)	LBI = IN (for preset)	3.51	3.6	3.69	V
		With resistors at LBI	0.98	1.00	1.02	
DBI Threshold (Falling)	Hysteresis is 5% (typ)	DBI = IN (for preset)	3.024	3.15	3.276	V
		With resistors at LBI	1.208	1.232	1.256	
\overline{RSO} Threshold (Falling)	Voltage on REG7, hysteresis is 5% (typ)		2.25	2.41	2.56	V
\overline{RSO} Deassert Delay			61	65.5	70	ms
LBI Input Bias Current		-50	-5			nA
DBI Input Bias Current			15	50		nA
Thermal-Shutdown Temperature	T_J rising		+160			$^{\circ}C$
Thermal-Shutdown Hysteresis			15			$^{\circ}C$
LOGIC INPUTS AND OUTPUTS						
\overline{LBO} , \overline{DBO} , POK, \overline{RSO} , SDA Output Low Level	$2.6V \leq V_7 \leq 5.5V$, sinking 1mA			0.4		V
\overline{LBO} , \overline{DBO} , POK, \overline{RSO} Output Low Level	$V_7 = 1V$, sinking 100 μA			0.4		V
\overline{LBO} , \overline{DBO} , POK, \overline{RSO} Output-High Leakage Current	$P_{in} = 5.5V$			0.2		μA
ON_, SCL, SDA, \overline{SLP} , PWM3, \overline{MR} , SRAD Input High Level	$2.6V \leq V_{IN} \leq 5.5V$	1.6				V
ON_, SCL, SDA, \overline{SLP} , PWM3, \overline{MR} , SRAD Input Low Level	$2.6V \leq V_{IN} \leq 5.5V$			0.4		V
ON_, SCL, SDA, \overline{SLP} , PWM3, \overline{MR} , SRAD Input Leakage Current	$P_{in} = GND, 5.5V$	-1		+1		μA
SERIAL INTERFACE						
Clock Frequency				400		kHz
Bus Free Time Between START and STOP		1.3				μs
Hold Time Repeated START Condition		0.6				μs
CLK Low Period		1.3				μs
CLK High Period		0.6				μs
Setup Time Repeated START Condition		0.6				μs
DATA Hold Time		0				μs
DATA Setup Time		100				ns
Maximum Pulse Width of Spikes that Must be Suppressed by the Input Filter of Both DATA and CLK Signals			50			ns
Setup Time for STOP Condition		0.6				μs

High-Efficiency, Low-Iq PMIC with Dynamic Core for PDAs and Smartphones

ELECTRICAL CHARACTERISTICS

($V_{IN} = 3.6V$, $V_{BKBT} = 3.0V$, $V_{LBI} = 1.1V$, $V_{DBI} = 1.35V$, circuit of Figure 5, $T_A = -40^{\circ}C$ to $+85^{\circ}C$, unless otherwise noted.) (Note 5)

PARAMETER	CONDITIONS	MIN	MAX	UNITS
PV1, PV2, PV3, SLPIN, IN Supply Voltage Range	PV1, PV2, PV3, IN, and SLPIN must connect together externally	2.6	5.5	V
IN45, IN6 Supply Voltage Range		2.4	5.5	V
IN Undervoltage-Lockout (UVLO) Threshold	V_{IN} rising	2.25	2.55	V
	V_{IN} falling	2.200	2.525	
SYNCHRONOUS-BUCK PWM REG1				
REG1 Voltage Accuracy	FB1 = GND, $3.6V \leq V_{PV1} \leq 5.5V$, load = 0 to 1300mA	3.25	3.35	V
FB1 Voltage Accuracy	FB1 used with external resistors, $3.6V \leq V_{PV1} \leq 5.5V$, load = 0 to 1300mA	1.231	1.269	V
FB1 Input Current	FB1 used with external resistors		100	nA
Dropout Voltage	Load = 800mA (Note 1)		280	mV
	Load = 1300mA (Note 1)		450	
p-Channel On-Resistance	$I_{LX1} = -180mA$		0.3	Ω
	$I_{LX1} = -180mA$, $V_{PV1} = 2.6V$		0.35	
n-Channel On-Resistance	$I_{LX1} = 180mA$		0.225	Ω
	$I_{LX1} = 180mA$, $V_{PV1} = 2.6V$		0.25	
p-Channel Current-Limit Threshold		-1.55	-2.10	A
OUT1 Maximum Output Current	$2.6V \leq V_{PV1} \leq 5.5V$ (Note 3)	1.30		A
LX1 Leakage Current	$V_{PV1} = 5.5V$, LX1 = GND or PV1, $V_{ON1} = 0V$	-10	+10	μA
SYNCHRONOUS-BUCK PWM REG2				
REG2 Voltage Accuracy	FB2 = GND, $3.6V \leq V_{PV2} \leq 5.5V$, load = 0 to 900mA	2.463	2.537	V
	FB2 = IN, $3.6V \leq V_{PV2} \leq 5.5V$, load = 0 to 900mA	3.25	3.35	
FB2 Voltage Accuracy	FB2 used with external resistors, $3.6V \leq V_{PV2} \leq 5.5V$, load = 0 to 900mA	1.231	1.269	V
FB2 Input Current	FB2 used with external resistors, $V_{FB2} = 1.25V$		100	nA
Dropout Voltage	Load = 900mA (Note 1)		380	mV
p-Channel On-Resistance	$I_{LX2} = -180mA$		0.375	Ω
	$I_{LX2} = -180mA$, $V_{PV2} = 2.6V$		0.425	
n-Channel On-Resistance	$I_{LX2} = -180mA$		0.25	Ω
	$I_{LX2} = -180mA$, $V_{PV2} = 2.6V$		0.275	
p-Channel Current-Limit Threshold		-1.1	-1.50	A
OUT2 Maximum Output Current	$2.6V \leq V_{PV2} \leq 5.5V$ (Note 3)	0.9		A
LX2 Leakage Current	$V_{PV2} = 5.5V$, LX2 = GND or PV2, $V_{ON2} = 0V$	-10	+10	μA

High-Efficiency, Low-Iq PMIC with Dynamic Core for PDAs and Smartphones

MAX8588

ELECTRICAL CHARACTERISTICS (continued)

($V_{IN} = 3.6V$, $V_{BKBT} = 3.0V$, $V_{LBI} = 1.1V$, $V_{DBI} = 1.35V$, circuit of Figure 5, $T_A = -40^{\circ}C$ to $+85^{\circ}C$, unless otherwise noted.) (Note 5)

PARAMETER	CONDITIONS	MIN	MAX	UNITS	
SYNCHRONOUS-BUCK PWM REG3					
REG3 Output Voltage Accuracy	REG3 from 0.7V to 1.475V, $2.6V \leq V_{PV3} \leq 5.5V$	Load = 0 to 500mA	-1.5	+1.5	%
p-Channel On-Resistance	$I_{LX3} = -180mA$			0.375	Ω
	$I_{LX2} = -180mA$, $V_{PV3} = 2.6V$			0.425	
n-Channel On-Resistance	$I_{LX3} = 180mA$			0.25	Ω
	$I_{LX3} = 180mA$, $V_{PV3} = 2.6V$			0.275	
p-Channel Current-Limit Threshold			-0.60	-0.85	A
OUT3 Maximum Output Current	$2.6V \leq V_{PV3} \leq 5.5V$ (Note 3)		0.5		A
LX3 Leakage Current	$V_{PV3} = 5.5V$, LX3 = GND or PV2, $V_{ON3} = 0V$		-10	+10	μA
LDOs V4, V5, V6, V1 SLEEP, V2 SLEEP, AND V7 OUTPUT					
V4, V5, V6, V1 SLEEP, V2 SLEEP Output Current			35		mA
V7 Output Current			30		mA
REG4 Voltage Accuracy	Load = 0.1mA to 35mA		1.254	1.346	V
REG5 Voltage Accuracy	Load = 0.1mA to 35mA		1.061	1.139	V
IN45, IN6 Input Voltage Range			2.4	5.5	V
REG6 Output Voltage (POR Default to 0V, Set by Serial Input)	1.8V setting, load = 0.1mA to 35mA		1.737	1.863	V
	2.5V setting, load = 0.1mA to 35mA		2.412	2.588	
	3.0V setting, load = 0.1mA to 35mA		2.895	3.105	
V1 and V2 SLEEP Output Voltage Accuracy	Set to same output voltage as REG1 and REG2		-3.5	+3.5	%
V1 and V2 SLEEP Dropout Voltage	Load = 20mA			150	mV
V6 Dropout Voltage	3V mode, load = 30mA; 2.5V mode, load = 30mA			200	mV
V7 Switch Voltage Drop	Load = 20mA, $V_{BKBT} = V_{V1} = 3.0V$			200	mV
V4, V5, V6 Output Current Limit			40		mA
BKBT Leakage				1	μA
OSCILLATOR					
PWM Switching Frequency			0.93	1.07	MHz
SUPERVISORY/MANAGEMENT FUNCTIONS					
POK Trip Threshold (Note 4)	Rising		92	97	%
	Falling		88.5	92.5	
LBI Threshold (Falling)	Hysteresis is 5% (typ)	LBI = IN (for preset)	3.51	3.69	V
		With resistors at LBI	0.98	1.02	

High-Efficiency, Low-Iq PMIC with Dynamic Core for PDAs and Smartphones

ELECTRICAL CHARACTERISTICS (continued)

($V_{IN} = 3.6V$, $V_{BKBT} = 3.0V$, $V_{LBI} = 1.1V$, $V_{DBI} = 1.35V$, circuit of Figure 5, $T_A = -40^{\circ}C$ to $+85^{\circ}C$, unless otherwise noted.) (Note 5)

PARAMETER	CONDITIONS	MIN	MAX	UNITS	
DBI Threshold (Falling)	Hysteresis is 5% (typ)	DBI = IN (for preset)	2.993	3.307	V
		With resistors at LBI	1.208	1.256	
\overline{RSO} Threshold (Falling)	Voltage on REG7, hysteresis is 5% (typ)	2.25	2.60	V	
\overline{RSO} Deassert Delay		62	69	ms	
LBI Input Bias Current		-50		nA	
DBI Input Bias Current			75	nA	
LOGIC INPUTS AND OUTPUTS					
\overline{LBO} , \overline{DBO} , POK, \overline{RSO} , SDA Output Low Level	$2.6V \leq V_7 \leq 5.5V$, sinking 1mA		0.4	V	
\overline{LBO} , \overline{DBO} , POK, \overline{RSO} , SDA Output Low Level	$V_7 = 1V$, sinking 100 μ A		0.4	V	
\overline{LBO} , \overline{DBO} , POK, \overline{RSO} Output-High Leakage Current	$P_{in} = 5.5V$		0.2	μ A	
ON_, SCL, SDA, \overline{SLP} , PWM3, \overline{MR} , SRAD Input High Level	$2.6V \leq V_{IN} \leq 5.5V$	1.6		V	
ON_, SCL, SDA, \overline{SLP} , PWM3, \overline{MR} , SRAD Input Low Level	$2.6V \leq V_{IN} \leq 5.5V$		0.4	V	
ON_, SCL, SDA, \overline{SLP} , PWM3, \overline{MR} , SRAD Input Leakage Current	$P_{in} = GND, 5.5V$	-1	+1	μ A	
SERIAL INTERFACE					
Clock Frequency			400	kHz	
Bus Free Time Between START and STOP		1.3		μ s	
Hold Time Repeated START Condition		0.6		μ s	
CLK Low Period		1.3		μ s	
CLK High Period		0.6		μ s	
Setup Time Repeated START Condition		0.6		μ s	
DATA Hold Time		0		μ s	
DATA Setup Time		100		ns	
Setup Time for STOP Condition		0.6		μ s	

High-Efficiency, Low-I_Q PMIC with Dynamic Core for PDAs and Smartphones

MAX8588

ELECTRICAL CHARACTERISTICS (continued)

Note 1: Dropout voltage is guaranteed by the p-channel switch resistance and assumes a maximum inductor resistance of 45mΩ.

Note 2: The PWM-skip-mode transition has approximately 10mA of hysteresis.

Note 3: The maximum output current is guaranteed by the following equation:

$$I_{OUTmax} = \frac{I_{LIM} - \frac{V_{OUT} (1 - D)}{2 \times f \times L}}{1 + (R_N + R_L) \frac{(1 - D)}{2 \times f \times L}}$$

where:

$$D = \frac{V_{OUT} + I_{OUT(MAX)} (R_N + R_L)}{V_{IN} + I_{OUT(MAX)} (R_N - R_P)}$$

and R_N = n-channel synchronous rectifier $R_{DS(ON)}$

R_P = p-channel power switch $R_{DS(ON)}$

R_L = external inductor ESR

$I_{OUT(MAX)}$ = maximum required load current

f = operating frequency minimum

L = external inductor value

I_{LIM} can be substituted for $I_{OUT(MAX)}$ (desired) when solving for D . This assumes that the inductor ripple current is small relative to the absolute value.

Note 4: POK only indicates the status of supplies that are enabled (except V7). When a supply is turned off, POK does not trigger low. When a supply is turned on, POK immediately goes low until that supply reaches regulation. POK is forced low when all supplies (except V7) are disabled.

Note 5: Specifications to -40°C are guaranteed by design, not production tested.

High-Efficiency, Low-Iq PMIC with Dynamic Core for PDAs and Smartphones

Typical Operating Characteristics

(Circuit of Figure 6, $V_{IN} = 3.6V$, $T_A = +25^{\circ}C$, unless otherwise noted.)

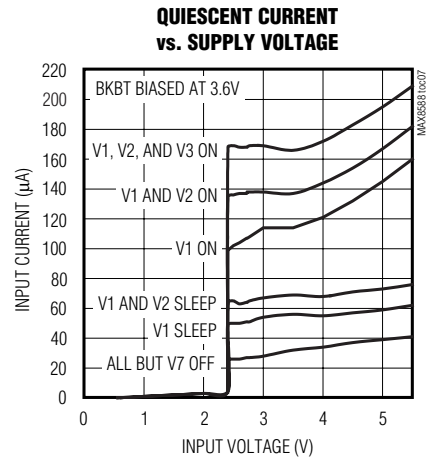
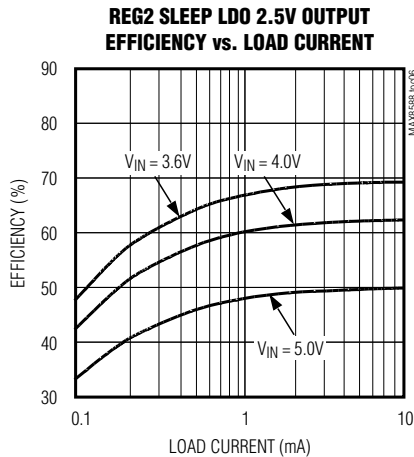
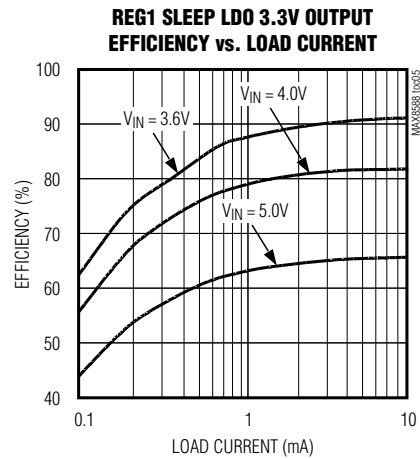
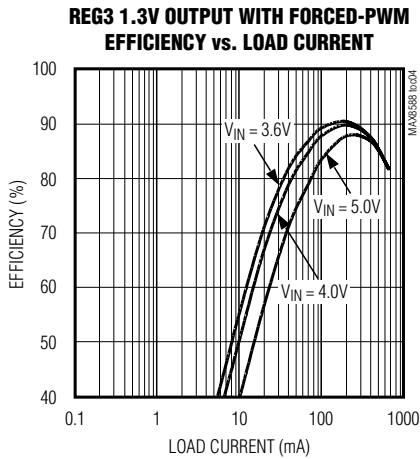
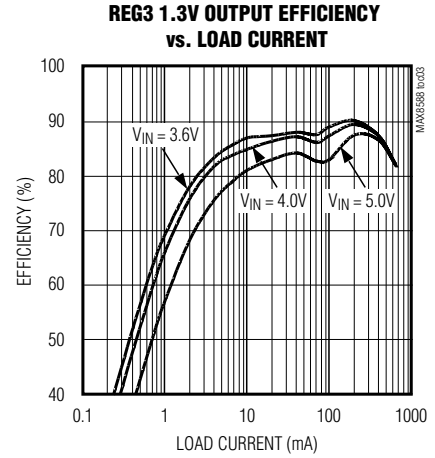
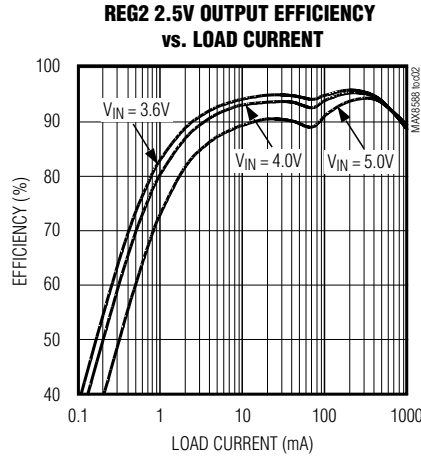
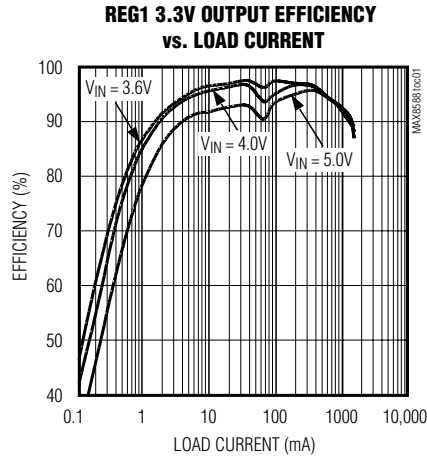

High-Efficiency, Low-Iq PMIC with Dynamic Core for PDAs and Smartphones

MAX8588

Typical Operating Characteristics (continued)

(Circuit of Figure 6, $V_{IN} = 3.6V$, $T_A = +25^\circ C$, unless otherwise noted.)

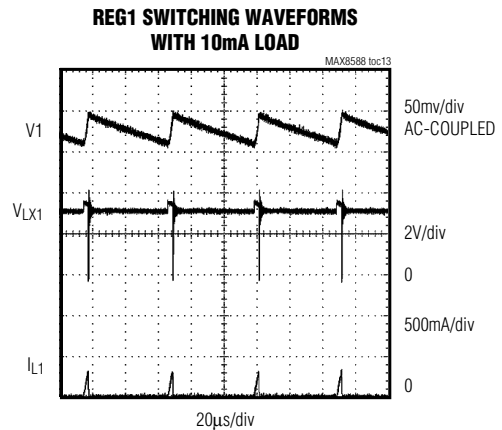
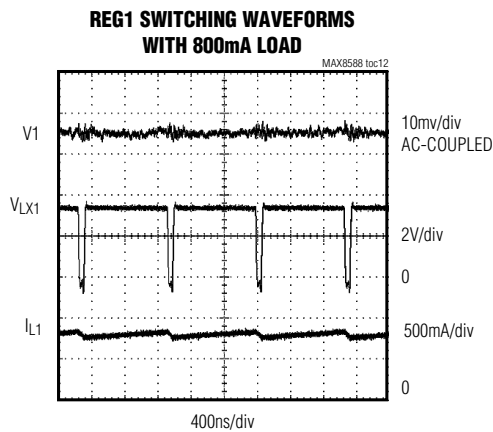
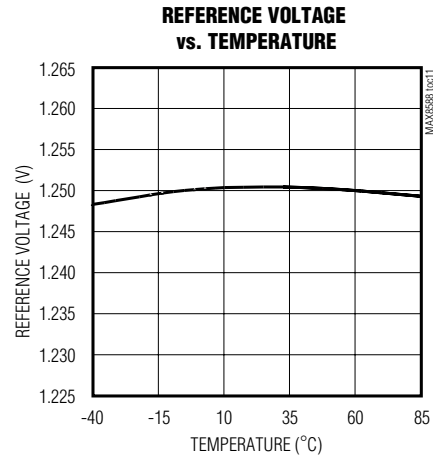
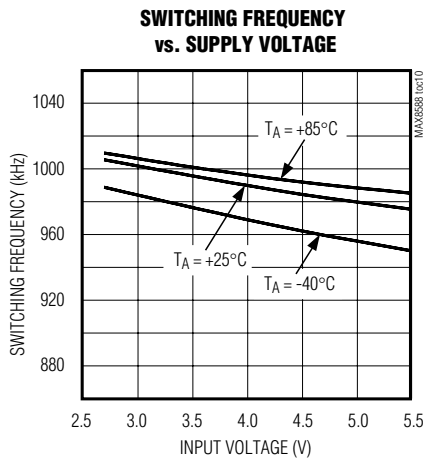
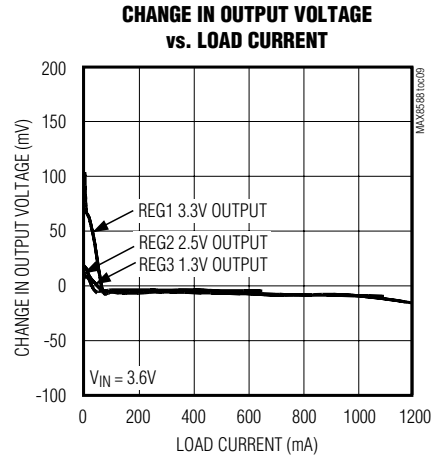
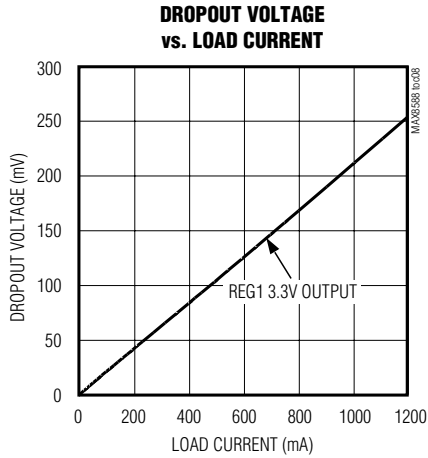

High-Efficiency, Low-Iq PMIC with Dynamic Core for PDAs and Smartphones

Typical Operating Characteristics (continued)

(Circuit of Figure 6, $V_{IN} = 3.6V$, $T_A = +25^\circ C$, unless otherwise noted.)

REG3 SWITCHING WAVEFORMS WITH 250mA LOAD

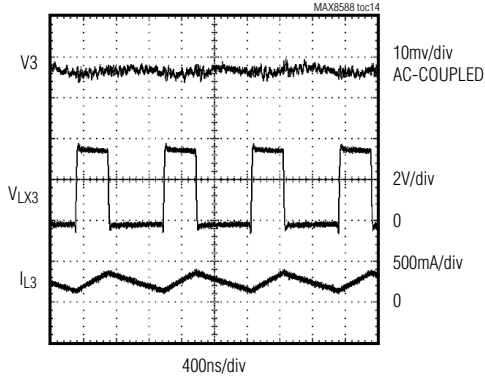

REG3 PULSE-SKIP SWITCHING WAVEFORMS WITH 10mA LOAD

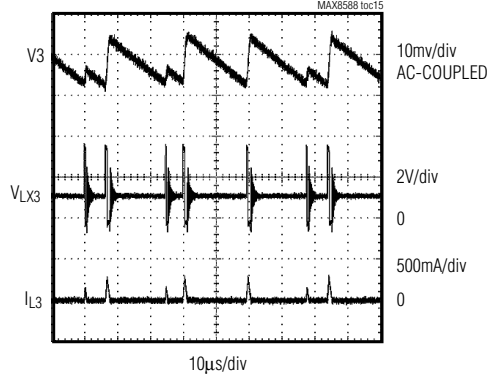

REG3 FORCED-PWM SWITCHING WAVEFORMS WITH 10mA LOAD

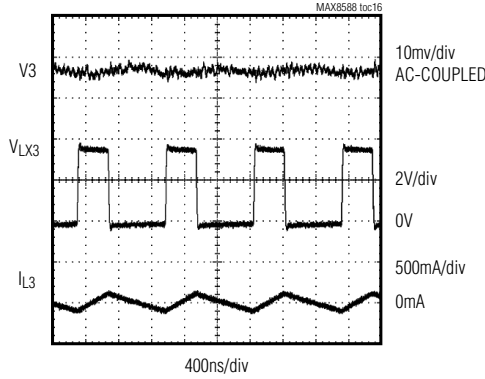

V7 AND RSO STARTUP WAVEFORMS

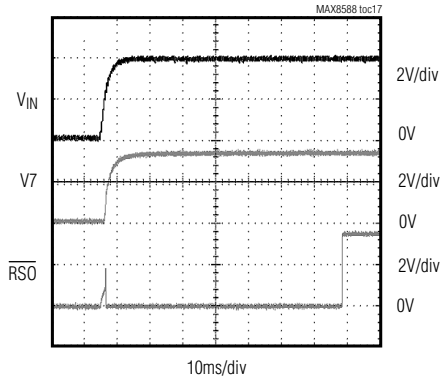

SYS_EN STARTUP WAVEFORMS

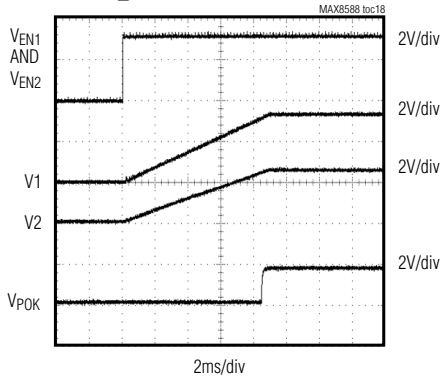

PWR_EN STARTUP WAVEFORMS

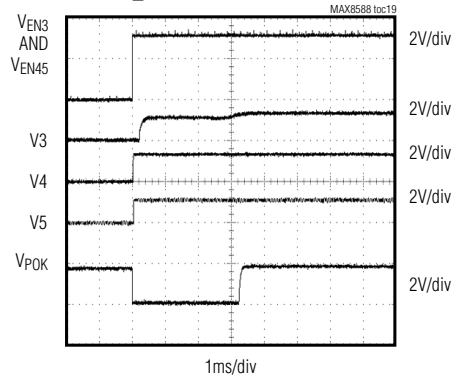

High-Efficiency, Low-I_Q PMIC with Dynamic Core for PDAs and Smartphones

MAX8588

Typical Operating Characteristics (continued)

(Circuit of Figure 6, $V_{IN} = 3.6V$, $T_A = +25^\circ C$, unless otherwise noted.)

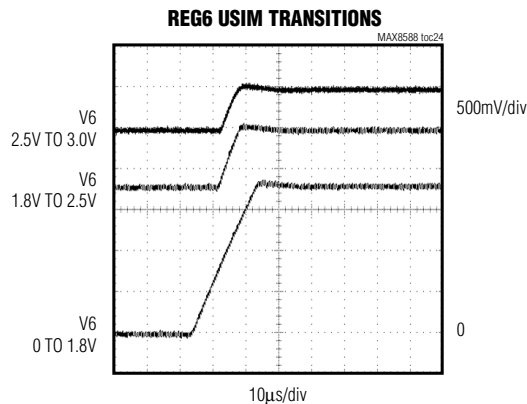
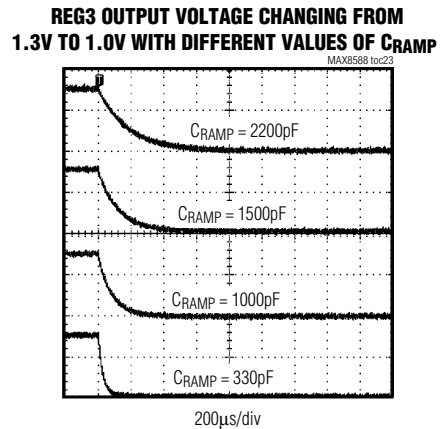
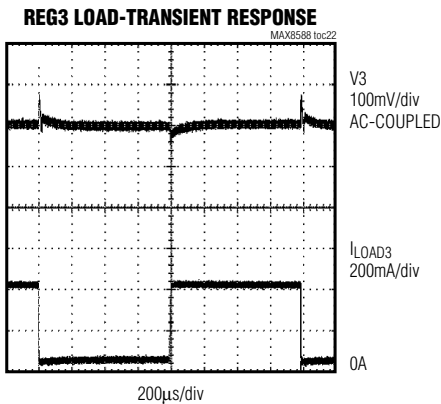
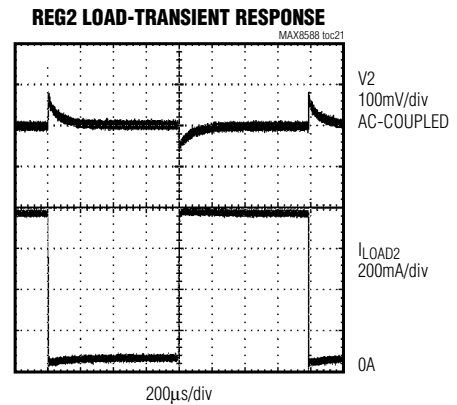
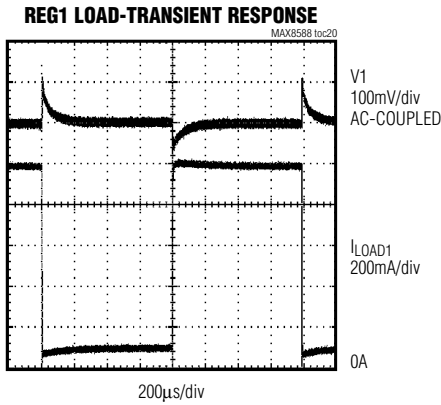

High-Efficiency, Low-Iq PMIC with Dynamic Core for PDAs and Smartphones

Pin Description

PIN	NAME	FUNCTION
1	LBI	Dual-Mode™, Low-Battery Input. Connect to IN to set the low-battery threshold to 3.6V (no resistors needed). Connect LBI to a resistor-divider for an adjustable LBI threshold. When IN is below the set threshold, $\overline{\text{LBO}}$ output switches low. $\overline{\text{LBO}}$ is deactivated and forced low when IN is below the dead-battery (DBI) threshold and when all REGs are disabled.
2	CC1	REG1 Compensation Node. Connect a series resistor and capacitor from CC1 to GND to compensate the regulation loop. See the <i>Compensation and Stability</i> section.
3	FB1	REG1 Feedback Input. Connect FB1 to GND to set V1 to 3.3V. Connect FB1 to external feedback resistors for other output voltages.
4	BKBT	Input Connection for Backup Battery. This input can also accept the output of an external boost converter.
5	V7	Also known as VCC_BATT. V7 is always active if main or backup power is present. It is the first regulator that powers up. V7 has two states: 1) V7 tracks V1 if ON1 is high and V1 is in regulation. 2) V7 tracks V_{BKBT} when ON1 is low or V1 is out of regulation.
6	V1	REG1 Voltage-Sense Input. Connect directly to the REG1 output voltage. The output voltage is set by FB1 to either 3.3V or adjustable with resistors.
7	SLPIN	Input to V1 and V2 Sleep Regulators. The input to the standby regulators at V1 and V2. Connect SLPIN to IN.
8	V2	REG2 Voltage-Sense Input. Connect directly to the REG2 output voltage. The output voltage is set by FB2 to either 3.3V/2.5V or adjustable with resistors.
9	FB2	REG2 Feedback Input. Connect to GND to set V2 to 2.5V on all devices. Connect FB2 to IN to set V2 to 3.3V. Connect FB2 to external feedback resistors for other voltages.
10	CC2	REG2 Compensation Node. Connect a series resistor and capacitor from CC2 to GND to compensate the regulation loop. See the <i>Compensation and Stability</i> section.
11	POK	Power-OK Output. Open-drain output that is low when any of the V1–V6 outputs are below their regulation threshold. When all activated outputs are in regulation, POK is high impedance. POK maintains a valid low output with V7 as low as 1V. POK does not flag an out-of-regulation condition while REG3 is transitioning between voltages set by serial programming. POK also does not flag for any REG channel that has been turned off; however, if <i>all</i> REG channels are off (V1–V6), then POK is forced low. If $\text{IN} < \text{UVLO}$, then POK is low. POK is expected to connect to nVCC_FAULT.
12	SCL	Serial Clock Input
13	SDA	Serial Data Input. Serial data programs the REG3 (core) and REG6 (VCC_USIM) voltage. REG3 and REG6 can be programmed even when off, but at least one of the ON_ pins must be logic-high to activate the serial interface. On power-up, REG3 defaults to 1.3V and REG6 defaults to 0V.
14	PWM3	Force V3 to PWM at All Loads. Connect PWM3 to GND for normal operation (skip mode at light loads). Drive or connect high for forced-PWM operation at all loads for V3 only.
15	$\overline{\text{LBO}}$	Low-Battery Output. Open-drain output that goes low when IN is below the threshold set by LBI.

Dual Mode is a trademark of Maxim Integrated Products, Inc.

High-Efficiency, Low-Iq PMIC with Dynamic Core for PDAs and Smartphones

Pin Description (continued)

MAX8588

PIN	NAME	FUNCTION
16	PV2	REG2 Power Input. Bypass to PG2 with a 4.7 μ F or greater low-ESR capacitor. PV1, PV2, PV3, and IN must connect together externally.
17	LX2	REG2 Switching Node. Connects to REG2 inductor.
18	PG2	REG2 Power Ground. Connect directly to a power-ground plane. Connect PG1, PG2, PG3, and GND together at a single point as close to the IC as possible.
19	IN	Main Battery Input. This input provides power to the IC.
20	RAMP	V3 Ramp-Rate Control. A capacitor connected from RAMP to GND sets the rate-of-change when V3 is changed. The output impedance of RAMP is 100k Ω . FB3 regulates to 1.28 x V _{RAMP} .
21	GND	Analog Ground
22	REF	Reference Output. Output of the 1.25V reference. Bypass to GND with a 0.1 μ F or greater capacitor.
23	BYP	Low-Noise LDO Bypass. Low-noise bypass pin for V4 LDO. Connect a 0.01 μ F capacitor from BYP to GND.
24	$\overline{\text{DBO}}$	Dead or Missing Battery Output. $\overline{\text{DBO}}$ is an open-drain output that goes low when IN is below the threshold set by DBI. $\overline{\text{DBO}}$ does not deactivate any regulator outputs. $\overline{\text{DBO}}$ is expected to connect to nBATT_FAULT on Intel CPUs.
25	ON2	On/Off Input for REG2. Drive high to turn on. When enabled, the REG2 output soft-starts. ON2 has hysteresis so an RC can be used to implement manual sequencing with respect to other inputs. It is expected that ON1, ON2, and ON6 are connected to SYS_EN.
26	ON4	On/Off Input for REG4. Drive high to turn on. When enabled, the REG4 output activates. ON4 has hysteresis so an RC can be used to implement manual sequencing with respect to other inputs. It is expected that ON4 is connected to PWR_EN.
27	V4	Also Known as VCC_PLL. 1.3V, 35mA linear-regulator output for PLL. Regulator input is IN45.
28	IN45	Power Input to V4 and V5 LDOs. Typically connected to V2, but can also connect to IN or another voltage from 2.5V to V _{IN} .
29	V5	Also Known as VCC_SRAM. 1.1V, 35mA linear-regulator output for CPU SRAM. Regulator input is IN45.
30	ON5	On/Off Input for REG5. Drive high to turn on. When enabled, the MAX8588 soft-starts the REG5 output. ON5 has hysteresis so an RC can be used to implement manual sequencing with respect to other inputs. It is expected that ON5 is connected to PWR_EN.
31	PG3	REG3 Power Ground. Connect directly to a power-ground plane. Connect PG1, PG2, PG3, and GND together at a single point as close to the IC as possible.
32	LX3	REG3 Switching Node. Connects to the REG3 inductor.
33	PV3	REG3 Power Input. Bypass to PG3 with a 4.7 μ F or greater low-ESR ceramic capacitor. PV1, PV2, PV3, and IN must connect together externally.
34	ON3	On/Off Input for REG3 (Core). Drive high to turn on. When enabled, the REG3 output ramps up. ON3 has hysteresis so an RC can be used to implement manual sequencing with respect to other inputs. It is expected that ON3 is driven from CPU SYS_EN.

High-Efficiency, Low-Iq PMIC with Dynamic Core for PDAs and Smartphones

Pin Description (continued)

PIN	NAME	FUNCTION
35	SRAD	Serial Address Bit. SRAD allows the serial address to be changed in case it conflicts with another serial device. If SRAD = GND, A1 = 0. If SRAD = IN, A1 = 1.
36	$\overline{\text{RSO}}$	Open-Drain Reset Output. Deasserts when V7 exceeds 2.55V (typ rising). Has 65ms delay before release. $\overline{\text{RSO}}$ is expected to connect to nRESET on the CPU.
37	$\overline{\text{MR}}$	Manual Reset Input. A low input at $\overline{\text{MR}}$ causes the $\overline{\text{RSO}}$ output to go low and also resets the V3 output to its default 1.3V setting. MR impacts no other functions.
38	CC3	REG 3 Compensation Node. Connect a series resistor and capacitor from CC3 to GND to compensate the regulation loop. See the <i>Compensation and Stability</i> section.
39	FB3	REG3 Feedback-Sense Input. Connect directly to the REG3 output voltage. Output voltage is set by the serial interface.
40	ON6	On/Off Input for REG6. Drive high to turn on. When enabled, the REG6 output activates. ON6 has hysteresis so an RC can be used to implement manual sequencing with respect to other inputs. It is expected that ON1, ON2, and ON6 are connected to SYS_EN.
41	V6	Also known as VCC_USIM. Linear-regulator output. This voltage is programmable through the I ² C interface to 0V, 1.8V, 2.5V, or 3.0V. The default voltage is 0V. REG6 is activated when ON6 is high.
42	IN6	Power Input to the V6 LDO. Typically connected to V1, but can also connect to IN.
43	PG1	REG1 Power Ground. Connect directly to a power-ground plane. Connect PG1, PG2, PG3, and GND together at a single point as close to the IC as possible.
44	LX1	REG1 Switching Node. Connects to the REG1 inductor.
45	PV1	REG1 Power Input. Bypass to PG2 with a 4.7 μ F or greater low-ESR ceramic capacitor. PV1, PV2, PV3, and IN must connect together externally.
46	ON1	On/Off Input for REG1. Drive high to turn on REG1. When enabled, the REG1 output soft-starts. ON1 has hysteresis so an RC can be used to implement manual sequencing with respect to other inputs. It is expected that ON1, ON2, and ON6 connect to SYS_EN.
47	$\overline{\text{SLP}}$	Sleep Input. $\overline{\text{SLP}}$ selects which regulators ON1 and ON2 turn on. $\overline{\text{SLP}}$ = high is normal operation (ON1 and ON2 are the enables for the V1 and V2 DC-DC converters). $\overline{\text{SLP}}$ = low is sleep operation (ON1 and ON2 are the enables for the V1 and V2 LDOs).
48	DBI	Dual-Mode, Dead-Battery Input. Connect DBI to IN to set the dead-battery falling threshold to 3.15V (no resistors needed). Connect DBI to a resistor-divider for an adjustable DBI threshold.
EP	EP	Exposed Metal Pad. Connect the exposed pad to ground. Connecting the exposed pad to ground does not remove the requirement for proper ground connections to the appropriate ground pins.

High-Efficiency, Low-IQ PMIC with Dynamic Core for PDAs and Smartphones

MAX8588

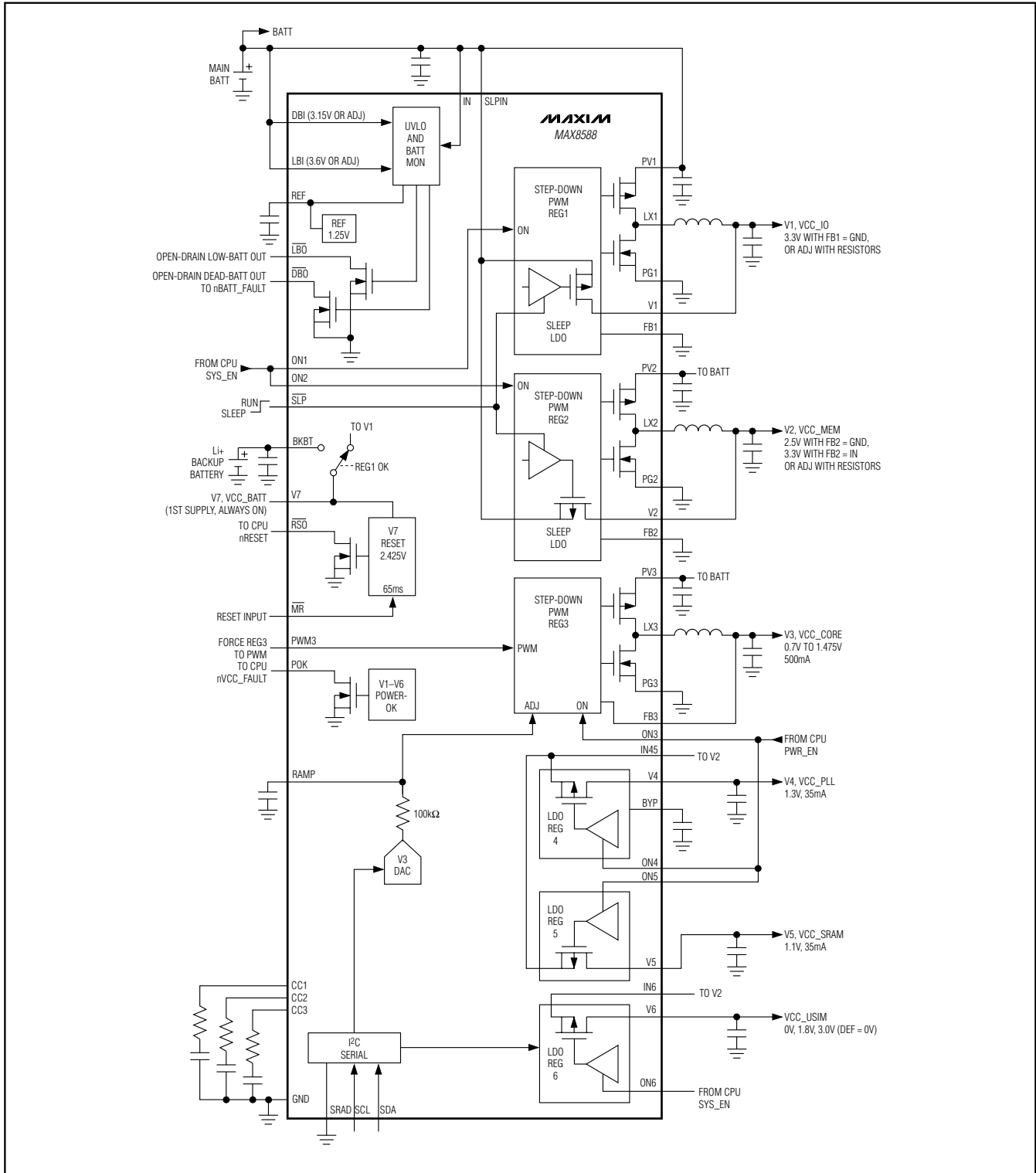

Figure 1. MAX8588 Functional Diagram

High-Efficiency, Low-Iq PMIC with Dynamic Core for PDAs and Smartphones

Detailed Description

The MAX8588 power-management IC is optimized for devices using Intel X-Scale microprocessors, including third-generation smart cell phones, PDAs, internet appliances, and other portable devices requiring substantial computing and multimedia capability at low power. The MAX8588 complies with Intel Processor Power specifications.

The IC integrates seven high-performance, low-operating-current power supplies along with supervisory and management functions. Regulator outputs include three step-down DC-DC outputs (V1, V2, and V3), three linear regulators (V4, V5, and V6), and one always-on output, V7 (Intel VCC_BATT). The V1 step-down DC-DC converter provides 3.3V or adjustable output voltage for I/O and peripherals. The V2 step-down DC-DC converter is preset for 3.3V or 2.5V. V2 can also be adjusted with external resistors on all parts. The V3 step-down DC-DC converter provides a serial-programmed output for powering microprocessor cores. The three linear regulators (V4, V5, and V6) provide power for PLL, SRAM, and USIM.

To minimize sleep-state quiescent current, V1 and V2 have bypass “sleep” LDOs that can be activated to minimize battery drain when output current is very low. Other functions include separate on/off control for all DC-DC converters, low-battery and dead-battery detection, a power-OK output, a backup-battery input, and a two-wire serial interface.

All DC-DC outputs use fast, 1MHz PWM switching and small external components. They operate with fixed-frequency PWM control and automatically switch from PWM to skip-mode operation at light loads to reduce operating current and extend battery life. The V3 core output is capable of forced-PWM operation at all loads. The 2.6V to 5.5V input voltage range allows 1-cell Li+, 3-cell NiMH, or a regulated 5V input.

The following power-supply descriptions include the Intel terms for the various voltages in parenthesis. For example, the V1 output is referred to as VCC_IO in Intel documentation. See Figure 1.

V1 and V2 (VCC_IO, VCC_MEM) Step-Down DC-DC Converters

V1 is a 1MHz current-mode step-down converter. The V1 output voltage can be preset to 3.3V or adjusted using a resistor voltage-divider. V1 supplies loads up to 1300mA.

V2 is also a 1MHz current-mode step-down converter. The V2 step-down DC-DC converter is preset for 3.3V or 2.5V. V2 can also be adjusted with external resistors on all parts. V2 supplies loads up to 900mA.

Under moderate to heavy loading, the converters operate in a low-noise PWM mode with constant frequency and modulated pulse width. Switching harmonics generated by fixed-frequency operation are consistent and easily filtered. Efficiency is enhanced under light loading (<30mA typ), by assuming an Idle Mode™ during which the converter switches only as needed to service the load.

Synchronous Rectification

Internal n-channel synchronous rectifiers eliminate the need for external Schottky diodes and improve efficiency. The synchronous rectifier turns on during the second half of each cycle (off-time). During this time, the voltage across the inductor is reversed, and the inductor current falls. In normal operation (not forced PWM), the synchronous rectifier turns off at the end of the cycle (at which time another on-time begins) or when the inductor current approaches zero.

100% Duty-Cycle Operation

If the inductor current does not rise sufficiently to supply the load during the on-time, the switch remains on, allowing operation up to 100% duty cycle. This allows the output voltage to maintain regulation while the input voltage approaches the regulation voltage. Dropout voltage is approximately 180mV for an 800mA load on V1 and 220mV for an 800mA load on V2. During dropout, the high-side p-channel MOSFET turns on, and the controller enters a low-current-consumption mode. The device remains in this mode until the regulator channel is no longer in dropout.

Sleep LDOs

In addition to the high-efficiency step-down converters, V1 and V2 can also be supplied with low-quiescent current, low-dropout (LDO) linear regulators that can be used in sleep mode or at any time when the load current is very low. The sleep LDOs can source up to 35mA. To enable the sleep LDOs, drive SLP low. When SLP is high, the switching step-down converters are active. The output voltage of the sleep LDOs is set to be the same as the switching step-down converters as described in the *Setting the Output Voltages* section. SLPIN is the input to the V1 and V2 sleep LDOs and must connect to IN.

Idle Mode is a trademark of Maxim Integrated Products, Inc.

High-Efficiency, Low-Iq PMIC with Dynamic Core for PDAs and Smartphones

V3 (VCC_CORE) Step-Down DC-DC Converter

V3 is a 1MHz current-mode step-down converter. It supplies loads up to 500mA.

The V3 output is set by the I²C serial interface to between 0.7V and 1.475V in 25mV increments. The default output voltage on power-up, and after a reset, is 1.3V. See the *Serial Interface* section for programming details. See the *Applications Information* for instructions on how to increase the V3 output voltage.

Forced PWM on REG3

Under moderate to heavy loading, the V3 always operates in a low-noise PWM mode with constant frequency and modulated pulse width. Switching harmonics generated by fixed-frequency operation are consistent and easily filtered.

With light loads (<30mA) and PWM3 low, V3 operates in an enhanced-efficiency idle mode during which the converter switches only as needed to service the load. With PWM3 high, V3 operates in low-noise forced-PWM mode under all load conditions.

Linear Regulators (V4, V5, and V6)

V4 (VCC_PLL)

V4 is a linear regulator that provides a fixed 1.3V output and supplies loads up to 35mA. The power input for the V4 and V5 linear regulators is IN45, which is typically connected to V2. To enable V4, drive ON4 high, or drive ON4 low for shutdown. V4 is intended to connect to VCC_PLL.

V5 (VCC_SRAM)

V5 is a linear regulator that provides a fixed 1.1V output and supplies loads up to 35mA. The power input for the

V4 and V5 linear regulators is IN45, which is typically connected to V2. To enable V5, drive ON5 high, or drive ON5 low for shutdown. V5 is intended to connect to VCC_SRAM.

V6 (VCC_USIM)

V6 is a linear regulator that supplies loads up to 35mA. The V6 output voltage is programmed with the I²C serial interface to 0V, 1.8V, 2.5V, or 3.0V. The power-up default for V6 is 0V. See the *Serial Interface* section for details on changing the voltage. The power input for the V6 linear regulator is IN6, which is typically connected to V1. To enable V6, drive ON6 high, or drive ON6 low for shutdown. V6 is intended to connect to VCC_USIM.

V7 Always-On Output (VCC_BATT)

The V7 output is always active if V1 is enabled and in regulation or if backup power is present. When ON1 is high and V1 is in regulation, V7 is sourced from V1 by an internal MOSFET switch. When ON1 is low or V1 is out of regulation, V7 is sourced from BKBT by a second on-chip MOSFET. V7 can supply loads up to 30mA. V7 is intended to connect to VCC_BATT on Intel CPUs.

Due to variations in system implementation, BKBT and V7 can be utilized in different ways. See the *Backup-Battery Configurations* section for information on how to use BKBT and V7.

Quiescent Operating Current in Various States

The MAX8588 is designed for optimum efficiency and minimum operating current for all typical operating modes, including sleep and deep sleep. These states are outlined in Table 1.

Table 1. Quiescent Operating Current in Various States

OPERATING POWER MODE	DESCRIPTION	TYPICAL NO-LOAD OPERATING CURRENT
RUN	All supplies on and running.	225μA
IDLE	All supplies on and running, peripherals on.	
SENSE	All supplies on, minimal loading, peripherals monitored.	
STANDBY	All supplies on, minimal loading, peripherals not monitored.	
SLEEP	PWR_EN controlled voltages (V3, V4, V5) are off. V1 and V2 on.	60μA if V1 and V2 SLEEP LDOs on; 130μA if V1, V2 step-down DC-DCs enabled
DEEP SLEEP	All supplies off except V7. V7 biased from backup battery.	32μA if IN > DBI threshold; 4μA if IN < DBI threshold

High-Efficiency, Low-Iq PMIC with Dynamic Core for PDAs and Smartphones

Voltage Monitors, Reset, and Undervoltage-Lockout Functions

Undervoltage Lockout

When the input voltage is below 2.35V (typ), an undervoltage-lockout (UVLO) circuit disables the IC. The inputs remain high impedance while in UVLO, reducing battery load under this condition. All serial registers are maintained with the input voltage down to at least 2.35V.

Reset Output (\overline{RSO}) and \overline{MR} Input

The reset output (\overline{RSO}) is low when the \overline{MR} input is low or when V7 is below 2.425V. V7 is powered from V1 (when enabled) or the backup-battery input (BKBT). \overline{RSO} normally goes low:

- 1) When power is first applied in configurations with no separate backup battery (external diode from IN to BKBT).
- 2) When power is removed in configurations with no separate backup battery (external diode from IN to BKBT).
- 3) If the backup battery falls below 2.425V when V1 is off or out of regulation.
- 4) When the manual reset button is pressed (\overline{MR} goes low).

If $V_{IN} > 2.4V$, an internal timer delays the release of \overline{RSO} for 65ms after V7 rises above 2.3V. However, if $V_{IN} < 2.4V$ when V7 exceeds 2.3V, or if V_{IN} and V7 rise at the same time, \overline{RSO} deasserts immediately with no 65ms delay. There is no delay in the second case because the timer circuitry is deactivated to minimize operating current during V_{IN} undervoltage lockout.

If it is desired to have a 65ms \overline{RSO} release delay for any sequence of V_{IN} and V7, the circuit in Figure 2 may be used. An RC connected from IN to \overline{MR} delays the rise of \overline{MR} until after V_{IN} powers up. The 65ms timer is valid for either sequence of V7 and V_{IN} and does not release until 65ms after both are up. The only regulator output that affects \overline{RSO} is V7. \overline{RSO} will not respond to V1–V6, which are monitored by POK. Also, \overline{RSO} is high impedance and does not function if BKBT is not powered.

\overline{MR} is a manual reset input for hardware reset. A low input at \overline{MR} causes the \overline{RSO} output to go low for at least 65ms and also resets the V3 output to its default 1.3V setting and turns off the V6 output. \overline{MR} impacts no other MAX8588 functions.

Dead-Battery and Low-Battery Comparators—DBI, LBI

The DBI and LBI inputs monitor input power (usually a battery) and trigger the \overline{DBO} and \overline{LBO} outputs. The dead-battery comparator triggers \overline{DBO} when the battery

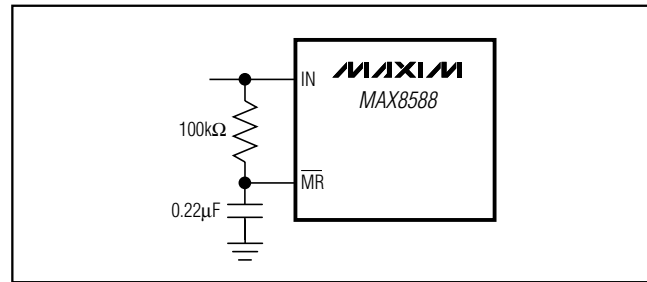

Figure 2. An RC delay connected from IN to \overline{MR} ensures that the 65ms \overline{RSO} release delay remains in effect for any sequence of IN and V7.

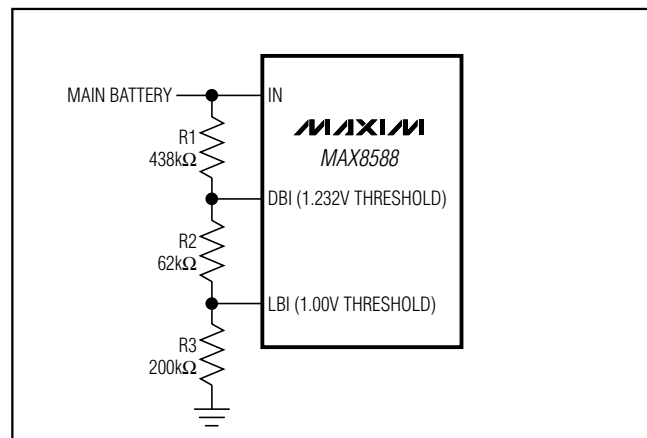

Figure 3. Setting the Low-Battery and Dead-Battery Thresholds with One Resistor Chain. The values shown set a DBI threshold of 3.3V and an LBI threshold of 3.5V (no resistors are needed for the factory preset thresholds).

(V_{IN}) discharges to the dead-battery threshold. The factory-set 3.15V threshold is selected by connecting DBI to IN, or the threshold can be programmed with a resistor-divider at DBI. The low-battery comparator has a factory-set 3.6V threshold that is selected by connecting LBI to IN, or its threshold can be programmed with a resistor-divider at LBI.

One three-resistor-divider can set both DBI and LBI (R1, R2, and R3 in Figure 3) according to the following equations:

- 1) Choose R3 to be less than 250k Ω
- 2) $R1 = R3 V_{LB} (1 - (1.232 / V_{DB}))$
- 3) $R2 = R3 (1.232 \times (V_{LB} / V_{DB}) - 1)$

where V_{LB} is the low-battery threshold and V_{DB} is the dead-battery threshold.

High-Efficiency, Low-Iq PMIC with Dynamic Core for PDAs and Smartphones

MAX8588

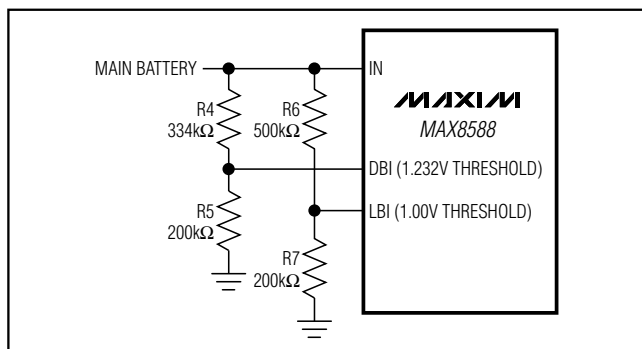

Figure 4. Setting the Low-Battery and Dead-Battery Thresholds with Separate Resistor-Dividers. The values shown set a DBI threshold of 3.3V and an LBI threshold of 3.5V (no resistors are needed for factory-preset thresholds).

Alternately, LBI and DBI can be set with separate two-resistor-dividers. Choose the lower resistor of the divider chain to be 250kΩ or less (R5 and R7 in Figure 4). The equations for upper divider-resistors as a function of each threshold are then:

$$R4 = R5 (V_{DB} / 1.232) - 1)$$

$$R6 = R7 (V_{LB} - 1)$$

When resistors are used to set V_{LB} , the threshold at LBI is 1.00V. When resistors are used to set V_{DB} , the threshold at DBI is 1.232V. A resistor-set threshold can also be used for only one of DBI or LBI. The other threshold can then be factory set by connecting the appropriate input to IN.

If BKBT is not powered, \overline{DBO} does not function and is high impedance. \overline{DBO} is expected to connect to nBATT_FAULT on Intel CPUs. If BKBT is not powered, \overline{LBO} does not function and is high impedance.

Power-OK Output (POK)

POK is an open-drain output that goes low when any activated regulator (V1–V6) is below its regulation threshold. POK does not monitor V7. When all active output voltages are within 10% of regulation, POK is high impedance. POK does not flag an out-of-regulation condition while V3 is transitioning between voltages set by serial programming or when any regulator channel has been turned off. POK momentarily goes low when any regulator is turned on, but returns high when that regulator reaches regulation. When all regulators (V1–V6) are off, POK is forced low. If the input voltage is below the UVLO threshold, POK is held low and maintains a valid low output with IN as low as 1V. If BKBT is not powered, POK does not function and is high impedance.

Connection to Processor and Power Sequencing

Typical processor connections have only power-control pins, typically labeled PWR_EN and SYS_EN. The MAX8588 provides numerous on/off control pins for maximum flexibility. In a typical application, many of these pins are connected together. ON1, ON2, and ON6 typically connect to SYS_EN. ON3, ON4, and ON5 typically connect to PWR_EN. V7 remains on as long as the main or backup power is connected. Sequencing is not performed internally on the MAX8588; however, all ON_ inputs have hysteresis and can connect to RC networks to set sequencing. For typical connections to Intel CPUs, no external sequencing is required.

Backup-Battery Input

The backup-battery input (BKBT) provides backup power for V7 when V1 is disabled. Normally, a primary or rechargeable backup battery is connected to this pin. If a backup battery is not used, then BKBT should connect to IN through a diode or external regulator. See the *Backup-Battery Configurations* section for information on how to use BKBT and V7.

Serial Interface

An I²C-compatible, two-wire serial interface controls REG3 and REG6. The serial interface operates when IN exceeds the 2.40V UVLO threshold and at least one of ON1–ON6 is asserted. The serial interface is shut down to minimize off-current drain when no regulators are enabled.

The serial interface consists of a serial data line (SDA) and a serial clock line (SCL). Standard I²C-compatible write-byte commands are used. Figure 4 shows a timing diagram for the I²C protocol. The MAX8588 is a slave-only device, relying upon a master to generate a clock signal. The master (typically a microprocessor) initiates data transfer on the bus and generates SCL to permit data transfer. A master device communicates to the MAX8588 by transmitting the proper address followed by the 8-bit data code (Table 2). Each transmit sequence is framed by a START (A) condition and a STOP (L) condition. Each word transmitted over the bus is 8 bits long and is always followed by an acknowledge clock pulse.

Table 2 shows the serial data codes used to program V3 and V6. The default power-up voltage for V3 is 1.3V and for V6 is 0V.

High-Efficiency, Low-Iq PMIC with Dynamic Core for PDAs and Smartphones

MAX8588

Table 2. V3 and V6 Serial Programming Codes

D7	D6	D5 0 = PROG V3 1 = PROG V6	D4	D3	D2	D1	D0	OUTPUT (V)	DESCRIPTION	
X	X	0	0	0	0	0	0	0.700	V3, CORE VOLTAGES	
		0	0	0	0	0	1	0.725		
		0	0	0	0	1	0	0.750		
		0	0	0	0	1	1	0.775		
		0	0	0	1	0	0	0.800		
		0	0	0	1	0	1	0.825		
		0	0	0	1	1	0	0.850		
		0	0	0	1	1	1	0.875		
		0	0	1	0	0	0	0.900		
		0	0	1	0	0	1	0.925		
		0	0	1	0	1	0	0.950		
		0	0	1	0	1	1	0.975		
		0	0	1	1	0	0	1.000		
		0	0	1	1	1	0	1.025		
		0	0	1	1	1	1	1.050		
		0	0	1	1	1	1	1.075		
		0	1	0	0	0	0	1.100		
		0	1	0	0	0	1	1.125		
		0	1	0	0	1	0	1.150		
		0	1	0	0	1	1	1.175		
		0	1	0	1	0	0	1.200		
		0	1	0	1	0	1	1.225		
		0	1	0	1	1	0	1.250		
		0	1	0	1	1	1	1.275		
		0	1	1	0	0	0	1.300		
		0	1	1	0	0	1	1.325		
		0	1	1	0	1	0	1.350		
		0	1	1	0	1	1	1.375		
		0	1	1	1	1	0	1.400		
		0	1	1	1	1	0	1.425		
		0	1	1	1	1	1	1.450		
		0	1	1	1	1	1	1.475		
1	X	X	X	X	0	0	0	V6, USIM VOLTAGES		
1	X	X	X	X	0	1	1.8			
1	X	X	X	X	1	0	2.5			
1	X	X	X	X	1	1	3.0			

High-Efficiency, Low-Iq PMIC with Dynamic Core for PDAs and Smartphones

MAX8588

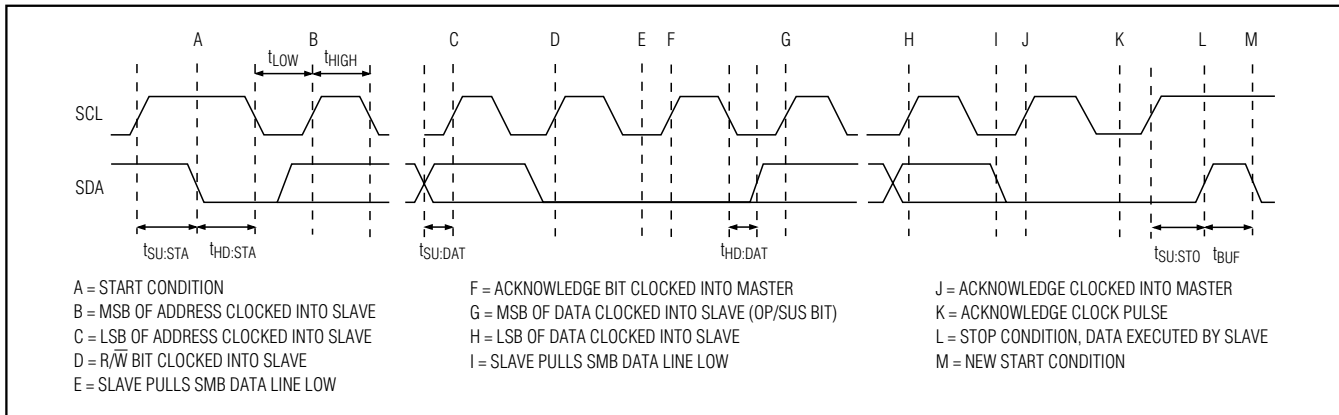

Figure 5. I²C-Compatible Serial-Interface Timing Diagram

Bit Transfer

One data bit is transferred during each SCL clock cycle. The data on SDA must remain stable during the high period of the SCL clock pulse. Changes in SDA while SCL is high are control signals (see the *START and STOP Conditions* section). Both SDA and SCL idle high when the bus is not busy.

START and STOP Conditions

When the serial interface is inactive, SDA and SCL idle high. A master device initiates communication by issuing a START condition. A START condition is a high-to-low transition on SDA with SCL high. A STOP condition is a low-to-high transition on SDA while SCL is high (Figure 5). A START condition from the master signals the beginning of a transmission to the MAX8588. The master terminates transmission by issuing a not acknowledge followed by a STOP condition (see the *Acknowledge Bit* section). The STOP condition frees the bus.

When a STOP condition or incorrect address is detected, the MAX8588 internally disconnects SCL from the serial interface until the next START condition, minimizing digital noise and feedthrough.

Acknowledge Bit (ACK)

The acknowledge bit (ACK) is the ninth bit attached to every 8-bit data word. The receiving device always generates ACK. The MAX8588 generates an ACK when receiving an address or data by pulling SDA low during the ninth clock period. Monitoring ACK allows for detection of unsuccessful data transfers. An unsuccessful data transfer occurs if a receiving device is busy or if a system fault has occurred. In the event of an unsuccessful data transfer, the bus master should reattempt communication at a later time.

Serial Address

A bus master initiates communication with a slave device by issuing a START condition followed by the 7-bit slave address (Table 3). When idle, the MAX8588 waits for a START condition followed by its slave address. The serial interface compares each address value bit by bit, allowing the interface to power down immediately if an incorrect address is detected.

The LSB of the address word is the read/write (R/W) bit. R/W indicates whether the master is writing or reading (RD/W 0 = write, RD/W 1 = read). The MAX8588 only supports the SEND BYTE format; therefore, RD/W is required to be 0.

After receiving the proper address, the MAX8588 issues an ACK by pulling SDA low for one clock cycle. The MAX8588 has two user-programmed addresses (Table 3). Address bits A6 through A1 are fixed, while A1 is controlled by SRAD. Connecting SRAD to GND sets A1 = 0. Connecting ADD to IN sets A1 = 1.

V3 Output Ramp-Rate Control

When V3 is dynamically changed with the serial interface, the output voltage changes at a rate controlled by a capacitor (C_{RAMP}) connected from RAMP to ground. The voltage change is a conventional RC exponential described by:

$$V_o(t) = V_o(0) + dV(1 - \exp(-t / (100k\Omega C_{RAMP})))$$

Table 3. Serial Address

SRAD	A7	A6	A5	A4	A3	A2	A1	A0 RD/W
0	0	0	1	0	1	0	0	0
1	0	0	1	0	1	0	1	0

High-Efficiency, Low-Iq PMIC with Dynamic Core for PDAs and Smartphones

A useful approximation is that it takes approximately 2.2 RC time constants for V3 to move from 10% to 90% of the voltage difference. For $C_{RAMP} = 1500\text{pF}$, this time is $330\mu\text{s}$. For a 1V to 1.3V change, this equates to $1\text{mV}/\mu\text{s}$. See the *Typical Operating Characteristics* for examples of different ramp-rate settings.

The maximum capacitor value that can be used at RAMP is 2200pF . If larger values are used, the V3 ramp rate is still controlled according to the above equation, but when V3 is first activated, POK indicates an “in regulation” condition before V3 reaches its final voltage.

The RAMP pin is effectively the reference for REG3. FB3 regulates to 1.28 times the voltage on RAMP.

Design Procedure

Setting the Output Voltages

The outputs V1 and V2 have preset output voltages, but can also be adjusted using a resistor voltage-divider. To set V1 to 3.3V, connect FB1 to GND. V2 can be preset to 3.3V or 2.5V. To set V2 to 3.3V, connect FB2 to IN. To set to 2.5V, connect FB2 to GND.

To set V1 or V2 to other than the preset output voltages, connect a resistor voltage-divider from the output voltage to the corresponding FB input. The FB_ input bias current is less than 100nA , so choose the low-side (FB_-to-GND) resistor (R_L) to be $100\text{k}\Omega$ or less. Then calculate the high-side (output-to-FB_) resistor (R_H) using:

$$R_H = R_L [(V_{OUT} / 1.25) - 1]$$

The V3 (VCC_CORE) output voltage is set from 0.7V to 1.475V in 25mV steps by the I²C serial interface. See the *Serial Interface* section for details.

Linear regulator V4 provides a fixed 1.3V output voltage. Linear regulator V5 provides a fixed 1.1V output voltage. V4 and V5 voltages are not adjustable.

The output voltage of linear regulator V6 (VCC_USIM) is set to 0V, 1.8V, 2.5V, or 3.0V by the I²C serial interface. See the *Serial Interface* section for details.

Linear regulator V7 (VCC_BATT) tracks the voltage at V1 as long as ON1 is high and V1 is in regulation. When ON1 is low or V1 is not in regulation, V7 switches to the backup battery (VBKBT).

Inductor Selection

The external components required for the step-down are an inductor, input-and-output filter capacitors, and a compensation RC network.

The MAX8588 step-down converter provides its best efficiency with continuous inductor current. A reasonable inductor value (L_{IDEAL}) is derived from:

$$L_{IDEAL} = [2(V_{IN}) \times D(1 - D)] / (I_{OUT(MAX)} \times f_{OSC})$$

This sets the peak-to-peak inductor current at 1/2 the DC inductor current. D is the duty cycle:

$$D = V_{OUT} / V_{IN}$$

Given L_{IDEAL} , the peak-to-peak inductor ripple current is $0.5 \times I_{OUT}$. The peak inductor current is $1.25 \times I_{OUT(MAX)}$. Make sure the saturation current of the inductor exceeds the peak inductor current and the rated maximum DC inductor current exceeds the maximum output current ($I_{OUT(MAX)}$). Inductance values larger than L_{IDEAL} can be used to optimize efficiency or to obtain the maximum possible output current. Larger inductance values accomplish this by supplying a given load current with a lower inductor peak current. Typically, output current and efficiency are improved for inductor values up to about two times L_{IDEAL} . If the inductance is raised too much, however, the inductor size may become too large, or the increased inductor resistance may reduce efficiency more than the gain derived from lower peak current.

Smaller inductance values allow smaller inductor sizes, but also result in larger peak inductor current for a given load. Larger output capacitance may then be needed to suppress the increase in output ripple caused by larger peak current.

Capacitor Selection

The input capacitor in a DC-DC converter reduces current peaks drawn from the battery or other input power source and reduces switching noise in the controller. The impedance of the input capacitor at the switching frequency should be less than that of the input source so high-frequency switching currents do not pass through the input source.

The output capacitor keeps output ripple small and ensures control-loop stability. The output capacitor must also have low impedance at the switching frequency. Ceramic, polymer, and tantalum capacitors are suitable, with ceramic exhibiting the lowest ESR and lowest high-frequency impedance.

Output ripple with a ceramic output capacitor is approximately:

$$V_{RIPPLE} = I_L(PEAK) [1 / (2\pi \times f_{OSC} \times C_{OUT})]$$

High-Efficiency, Low-Iq PMIC with Dynamic Core for PDAs and Smartphones

If the capacitor has significant ESR, the output ripple component due to capacitor ESR is:

$$V_{\text{RIPPLE(ESR)}} = I_{\text{L(PEAK)}} \times \text{ESR}$$

Output capacitor specifics are also discussed in the *Compensation and Stability* section.

Compensation and Stability

The relevant characteristics for REG1, REG2, and REG3 compensation are:

- 1) Transconductance (from FB_ to CC_), gmEA
- 2) Current-sense amplifier transresistance, RCS
- 3) Feedback regulation voltage, VFB (1.25V)
- 4) Step-down output voltage, VOUT, in V
- 5) Output load equivalent resistance, RLOAD = VOUT / ILOAD

The key steps for step-down compensation are:

- 1) Set the compensation RC zero to cancel the RLOAD COUT pole.
- 2) Set the loop crossover at or below approximately 1/10th the switching frequency.

For example, with VIN(MAX) = 5V, VOUT = 2.5V for REG2, and IOUT = 800mA, then RLOAD = 3.125Ω. For REG2, RCS = 0.75V/A and gmEA = 87μS.

Choose the crossover frequency, fc ≤ fOSC / 10. Choose 100kHz. Then calculate the value of the compensation capacitor, CC:

$$\begin{aligned} C_C &= (V_{\text{FB}} / V_{\text{OUT}}) \times (R_{\text{LOAD}} / R_{\text{CS}}) \times (g_m / (2\pi \times f_c)) \\ &= (1.25 / 2.5) \times (3.125 / 0.75) \times (87 \times 10^{-6} / (6.28 \times 100,000)) = 289\text{pF} \end{aligned}$$

Choose 330pF, the next highest standard value.

Now select the compensation resistor, RC, so transient-droop requirements are met. As an example, if 3% transient droop is allowed for the desired load step, the input to the error amplifier moves 0.03 x 1.25V, or 37.5mV. The error-amplifier output drives 37.5mV x gmEA, or IEAO = 37.5mV x 87μS = 3.26μA across RC to provide transient gain. Find the value of RC that allows the required load-step swing from:

$$R_C = R_{\text{CS}} \times I_{\text{IND(PK)}} / I_{\text{EAO}}$$

where IIND(PK) is the peak inductor current. In a step-down DC-DC converter, if LIDEAL is used, output current relates to inductor current by:

$$I_{\text{IND(PK)}} = 1.25 \times I_{\text{OUT}}$$

So for an 800mA output load step with VIN = 3.6V and VOUT = 2.5V:

Table 4. Compensation Parameters

PARAMETER	REG1	REG2	REG3
Error-Amplifier Transconductance, gmEA	87μS	87μS	68μS
Current-Sense Amp Transresistance, RCS	0.5V/A	0.75V/A	1.25V/A

Table 5. Typical Compensation Values

COMPONENT OR PARAMETER	REG1	REG2	REG3
VOUT	3.3V	2.5V	1.3V
Output Current	1300mA	900mA	500mA
Inductor	3.3μH	6.8μH	10μH
Load-Step Droop	3%	3%	3%
Loop Crossover Freq (fc)	100kHz	100kHz	100kHz
CC	330pF	270pF	330pF
RC	240kΩ	240kΩ	240kΩ
COUT	22μF	22μF	22μF

$$R_C = R_{\text{CS}} \times I_{\text{IND(PK)}} / I_{\text{EAO}} = (0.75\text{V/A}) \times (1.25 \times 0.8\text{A}) / 3.26\mu\text{A} = 230\text{k}\Omega$$

We choose 240kΩ. Note that the inductor does not limit the response in this case since it can ramp at (VIN - VOUT) / L, or (3.6 - 2.5) / 3.3μH = 242mA/μs.

The output-filter capacitor is then selected so that the COUT RLOAD pole cancels the RC CC zero:

$$C_{\text{OUT}} \times R_{\text{LOAD}} = R_C \times C_C$$

For the example:

$$R_{\text{LOAD}} = V_{\text{OUT}} \times I_{\text{LOAD}} = 2.5\text{V} / 0.8\text{A} = 3.125\Omega$$

$$C_{\text{OUT}} = R_C \times C_C / R_{\text{LOAD}} = 240\text{k}\Omega \times 330\text{pF} / 3.125\Omega = 25\mu\text{F}$$

We choose 22μF.

Recalculate RC using the selected COUT.

$$R_C = C_{\text{OUT}} \times R_{\text{LOAD}} / C_C = 208\text{k}\Omega$$