



Chipsmall Limited consists of a professional team with an average of over 10 year of expertise in the distribution of electronic components. Based in Hongkong, we have already established firm and mutual-benefit business relationships with customers from,Europe,America and south Asia,supplying obsolete and hard-to-find components to meet their specific needs.

With the principle of “Quality Parts,Customers Priority,Honest Operation,and Considerate Service”,our business mainly focus on the distribution of electronic components. Line cards we deal with include Microchip,ALPS,ROHM,Xilinx,Pulse,ON,Everlight and Freescale. Main products comprise IC,Modules,Potentiometer,IC Socket,Relay,Connector.Our parts cover such applications as commercial,industrial, and automotives areas.

We are looking forward to setting up business relationship with you and hope to provide you with the best service and solution. Let us make a better world for our industry!



Contact us

Tel: +86-755-8981 8866 Fax: +86-755-8427 6832

Email & Skype: info@chipsmall.com Web: www.chipsmall.com

Address: A1208, Overseas Decoration Building, #122 Zhenhua RD., Futian, Shenzhen, China



Low-Cost, SMBus, CCFL Backlight Controller

General Description

The MAX8759 integrated cold-cathode fluorescent lamp (CCFL) inverter controller is designed to drive CCFLs using a full-bridge resonant inverter. The resonant operation ensures reliable striking and provides near-sinusoidal waveforms over the entire input range. The controller operates over a wide input-voltage range of 4.5V to 28V with high power to light efficiency. The device also includes safety features that effectively protect against single-point fault conditions such as lamp-out, secondary overvoltage, and secondary short-circuit faults.

The MAX8759 provides accurate lamp-current regulation ($\pm 2.5\%$) for superior CCFL inverter performance. The lamp current is adjustable with an external resistor; 10:1 dimming range can be achieved by turning the CCFL on and off using a digital pulse-width modulation (DPWM) method, while maintaining the lamp-current constant. The MAX8759 provides three mechanisms for controlling brightness: 2-wire SMBus™-compatible interface, external ambient-light sensor (ALS), or system PWM control. The MAX8759 supports Intel display power-saving technology (DPST) to maximize battery life. The device includes two lamp-current feedback input pins that support dual-lamp applications with a minimum number of external components.

The MAX8759 controls a full-bridge inverter for maximum efficiency and directly drives four external n-channel power MOSFETs. An internal 5.35V linear regulator powers the MOSFET drivers and most of the internal circuitry. The MAX8759 is available in a space-saving, 28-pin, thin QFN package and operates over a -40°C to $+85^{\circ}\text{C}$ temperature range.

Applications

Notebooks
LCD Monitors
Automotive Infotainment

Ordering Information

PART	TEMP RANGE	PIN-PACKAGE	PKG CODE
MAX8759ETI+	-40°C to $+85^{\circ}\text{C}$	28 Thin QFN-EP* 5mm x 5mm	T2855-6

+Denotes a lead-free package.

*EP = Exposed pad.

Pin Configuration appears at end of data sheet.

SMBus is a trademark of Intel Corp.

Features

- ◆ Accurate Dimming Control Using SMBus, PWM Interface, or Ambient Light Sensor
- ◆ 10:1 Dimming Range with 256-Step Resolution
- ◆ Resonant-Mode Operation
 - Longer Lamp Life with Near Sinusoidal Lamp-Current Waveform
 - Guaranteed Striking Capability
 - High-Power-to-Light Efficiency
- ◆ Wide Input-Voltage Range (4.5V to 28V)
- ◆ Input Feed-Forward for Excellent Line Rejection
- ◆ $\pm 2.5\%$ Lamp-Current Regulation
- ◆ Adjustable 1.5% Accurate DPWM Frequency
- ◆ Dual Lamp-Current Feedback Inputs
 - Secondary Voltage Limiting
 - Primary Current Limit with Lossless Sensing
 - Lamp-Out Protection with Adjustable Timeout
 - Secondary Short-Circuit Protection
- ◆ Small 28-Pin, 5mm x 5mm, Thin QFN Package

Minimal Operating Circuit

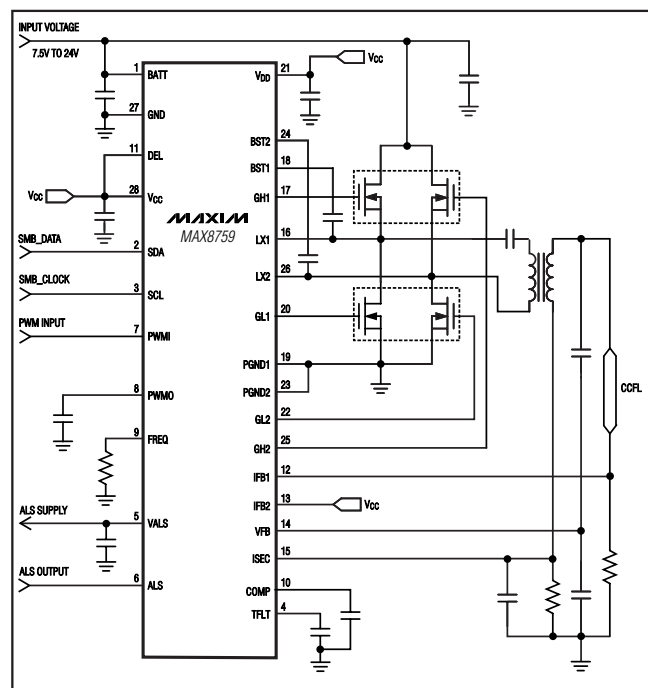

Low-Cost, SMBus, CCFL Backlight Controller

MAX8759

ABSOLUTE MAXIMUM RATINGS

BATT to GND	-0.3V to +30V
BST1, BST2 to GND	-0.3V to +36V
BST1 to LX1, BST2 to LX2	-0.3V to +6V
FREQ, VCC, VDD to GND	-0.3V to +6V
SDA, SCL to GND	-0.3V to +6V
ALS, COMP, PWMI, PWMO, TFLT, DEL, VALS to GND	-0.3V to (VCC + 0.3V)
GH1 to LX1	-0.3V to (VBST1 + 0.3V)
GH2 to LX2	-0.3V to (VBST2 + 0.3V)
GL1, GL2 to GND	-0.3V to (VDD + 0.3V)

IFB1, IFB2, ISEC, VFB to GND	-3V to +6V
PGND1, PGND2 to GND	-0.3V to +0.3V
Continuous Power Dissipation (TA = +70°C) 28-Pin Thin QFN 5mm x 5mm (derate 21.3mW/°C above +70°C)	1702mW
Operating Temperature Range	-40°C to +85°C
Junction Temperature	+150°C
Storage Temperature Range	-65°C to +150°C
Lead Temperature (soldering, 10s)	+300°C

Stresses beyond those listed under "Absolute Maximum Ratings" may cause permanent damage to the device. These are stress ratings only, and functional operation of the device at these or any other conditions beyond those indicated in the operational sections of the specifications is not implied. Exposure to absolute maximum rating conditions for extended periods may affect device reliability.

ELECTRICAL CHARACTERISTICS

(Circuit of Figure 1, VBATT = 12V, VCC = VDD, TA = 0°C to +85°C. Typical values are at TA = +25°C, unless otherwise noted.)

PARAMETER	CONDITIONS	MIN	TYP	MAX	UNITS	
BATT Input Voltage Range	VCC = VDD = VBATT	4.5		5.5	V	
	VCC = VDD = open	5.5		28.0		
BATT Quiescent Current	MAX8759 is enabled	VBATT = 28V		2.5	5	mA
		VBATT = VCC = 5V			5	
BATT Quiescent Current, Shutdown	MAX8759 is disabled		100	200	µA	
VCC Output Voltage, Normal Operation	MAX8759 is enabled, 6V < VBATT < 28V, 0 < ILOAD < 10mA	5.2	5.35	5.5	V	
VCC Output Voltage, Shutdown	MAX8759 is disabled, no load	3.5	4.3	5.5	V	
VCC Undervoltage Lockout Threshold	VCC rising (leaving lockout)			4.3	V	
	VCC falling (entering lockout)	3.7				
VCC Undervoltage Lockout Hysteresis			230		mV	
VCC POR Threshold	Rising edge		1.75		V	
VCC POR Hysteresis			50		mV	
GH1, GH2, GL1, GL2 On-Resistance, Low State	I _{TEST} = 100mA, VCC = VDD = 5V		3	6	Ω	
GH1, GH2, GL1, GL2 On-Resistance, High State	I _{TEST} = 100mA, VCC = VDD = 5V		10	18	Ω	
BST1, BST2 Leakage Current	VBST_ = 12V, VLX_ = 7V		4	10	µA	
Resonant Frequency Range	Guaranteed by design	30		80	kHz	
Minimum On-Time		350	500	700	ns	
Maximum Off-Time		40	60	80	µs	
Current-Limit Threshold	LX1 - PGND1, LX2 - PGND2	415	430	445	mV	
Zero-Current-Crossing Threshold	LX1 - PGND1, LX2 - PGND2	3	8	13	mV	
Current-Limit Leading-Edge Blanking			350		ns	
IFB1, IFB2 Input-Voltage Range		-3		+3	V	
IFB1 Regulation Point		765	785	805	mV	
IFB2 Regulation Point		780	800	820	mV	

Low-Cost, SMBus, CCFL Backlight Controller

MAX8759

ELECTRICAL CHARACTERISTICS (continued)

(Circuit of Figure 1, $V_{BATT} = 12V$, $V_{CC} = V_{DD}$, $T_A = 0^{\circ}C$ to $+85^{\circ}C$. Typical values are at $T_A = +25^{\circ}C$, unless otherwise noted.)

PARAMETER	CONDITIONS	MIN	TYP	MAX	UNITS
IFB1, IFB2 Input Bias Current	$0 < V_{IFB1,2} < 3V$	-3		+3	μA
	$-3V < V_{IFB1,2} < 0$	-230			
IFB1, IFB2 Lamp-Out Threshold		575	600	625	mV
IFB1, IFB2 to COMP Transconductance	$0.5V < V_{COMP} < 4V$	60	100	160	μS
COMP Output Impedance		6	12	24	$M\Omega$
COMP Discharge Current During Overvoltage or Overcurrent Fault	$V_{VFB} = 2.6V$ or $V_{ISEC} = 1.5V$	500	1000	2000	μA
COMP Discharge Current During DPWM Off-Time	$V_{COMP} = 1.5V$	90	110	130	μA
DPWM Rising-to-Falling Ratio	$V_{IFB1,2} = 0$		2.5		
ISEC Input Voltage Range		-3		+3	V
ISEC Overcurrent Threshold		1.18	1.21	1.26	V
ISEC Input Bias Current	$V_{ISEC} = 1.25V$	-0.3		+0.3	μA
VFB Input Voltage Range		-4		+4	V
VFB Input Impedance		150	300	450	$M\Omega$
VFB Overvoltage Threshold		2.2	2.3	2.4	V
VFB Undervoltage Threshold		210	240	280	mV
VFB Undervoltage Delay	$R_{FREQ} = 169k\Omega$		250		μs
DPWM Oscillator Frequency	$R_{FREQ} = 169k\Omega$, $T_A = +25^{\circ}C$ to $+85^{\circ}C$	207	210	213	Hz
	$R_{FREQ} = 169k\Omega$	205	210	215	
	$R_{FREQ} = 340k\Omega$		106		
	$R_{FREQ} = 100k\Omega$		343		
PWMO Output Impedance		20	40	60	$k\Omega$
PWMI Input Low Voltage				0.7	V
PWMI Input High Voltage		2.1			V
PWMI Input Hysteresis			300		mV
PWMI Input Bias Current		-0.3		+0.3	μA
PWMI Input Frequency Range		5		50	kHz
PWMI Full-Range Accuracy				5	LSB
PWMI Brightness Setting	PWMI duty cycle = 100%	98	100		%
	PWMI duty cycle = 50%	48	50	52	
	PWMI duty cycle = 0%	9.7	10.0	10.3	
ALS Full-Adjustment Range		0		1.8	V
ALS Full-Range Accuracy				5	LSB
ALS Input Bias Current		-0.1		+0.1	μA
VALS Output Voltage	MAX8759 is enabled, $6V < V_{BATT} < 28V$, $I_{LOAD} = 1mA$	5.10	5.30	5.50	V
VALS Leakage Current	MAX8759 is disabled, VALS = GND	-3		+3	μA
VALS On-Resistance	MAX8759 is enabled		30	60	Ω

Low-Cost, SMBus, CCFL Backlight Controller

MAX8759

ELECTRICAL CHARACTERISTICS (continued)

(Circuit of Figure 1, $V_{BATT} = 12V$, $V_{CC} = V_{DD}$, $T_A = 0^{\circ}C$ to $+85^{\circ}C$. Typical values are at $T_A = +25^{\circ}C$, unless otherwise noted.)

PARAMETER	CONDITIONS	MIN	TYP	MAX	UNITS
Zero-Crossing Delay	$V_{BATT} = 9V$, $R_{THR} = 120k\Omega$	0	0.15	0.30	μs
	$V_{BATT} = 12V$, $R_{THR} = 120k\Omega$	1.50	1.80	2.10	
Maximum Zero-Crossing Delay	$V_{BATT} = 18V$, $R_{THR} = 120k\Omega$	3.2	3.8	4.4	μs
DEL Disable Threshold	DEL rising			4.5	V
	DEL falling	3.8			
TFLT Charge Current	$V_{ISEC} < 1.25V$ and $V_{IFB} < 540mV$; $V_{FLT} = 2V$	0.9	1.0	1.1	μA
	$V_{ISEC} < 1.25V$ and $V_{IFB} > 660mV$; $V_{FLT} = 2V$	-1.5	-1.2	-0.8	
	$V_{ISEC} > 1.25V$ and $V_{IFB} > 660mV$; $V_{FLT} = 2V$	115	135	155	
TFLT Trip Threshold	Rising edge	3.7	4	4.3	V
SDA, SCL, Input Low Voltage				0.7	V
SDA, SCL, Input High Voltage		2.1			V
SDA, SCL, Input Hysteresis			100		mV
SDA, SCL, Input Bias Current		-1		+1	μA
SDA Output Low Sink Current	$V_{SDA} = 0.4V$	4			mA
SMBus Frequency		10		100	kHz
SMBus Free Time	t_{BUF}	4.7	1		μs
SCL Serial Clock High Period	t_{HIGH}	4			μs
SCL Serial Clock Low Period	t_{LOW}	4.7			μs
START Condition Setup Time	$t_{SU:STA}$	4.7			μs
START Condition Hold Time	$t_{HD:STA}$	4			μs
STOP Condition Setup Time from SCL	$t_{SU:STO}$	4			μs
SDA Valid to SCL Rising-Edge Setup Time, Slave Clocking in Data	$t_{SU:DAT}$	250			ns
SCL Falling Edge to SDA Transition	$t_{HD:DAT}$	0			ns
SCL Falling Edge to SDA Valid, Reading Out Data	t_{DV}	200			ns

Low-Cost, SMBus, CCFL Backlight Controller

MAX8759

ELECTRICAL CHARACTERISTICS

(Circuit of Figure 1, $V_{BATT} = 12V$, $V_{CC} = V_{DD}$, $T_A = -40^{\circ}C$ to $+85^{\circ}C$.) (Note 1)

PARAMETER	CONDITIONS	MIN	TYP	MAX	UNITS
BATT Input Voltage Range	$V_{CC} = V_{DD} = V_{BATT}$	4.5		5.5	V
	$V_{CC} = V_{DD} = \text{open}$	5.5		28.0	
BATT Quiescent Current	MAX8759 is enabled	$V_{BATT} = 28V$		5	mA
		$V_{BATT} = V_{CC} = 5V$		5	
V_{CC} Output Voltage, Normal Operation	MAX8759 is enabled, $6V < V_{BATT} < 28V$, $0 < I_{LOAD} < 10mA$	5.2		5.5	V
V_{CC} Output Voltage, Shutdown	MAX8759 is disabled, no load	3.5		5.5	V
V_{CC} Undervoltage Lockout Threshold	V_{CC} rising (leaving lockout)			4.3	V
	V_{CC} falling (entering lockout)	3.7			
GH1, GH2, GL1, GL2 On-Resistance, Low State	$I_{TEST} = 100mA$, $V_{CC} = V_{DD} = 5V$			6	Ω
GH1, GH2, GL1, GL2 On-Resistance, High State	$I_{TEST} = 100mA$, $V_{CC} = V_{DD} = 5V$			18	Ω
Resonant Frequency Range	Guaranteed by design	30		80	kHz
Minimum On-Time		350		700	ns
Maximum Off-Time		40		80	μs
Current-Limit Threshold	LX1 - PGND1, LX2 - PGND2	410		450	mV
Zero-Current Crossing Threshold	LX1 - PGND1, LX2 - PGND2	3		13	mV
IFB1, IFB2 Input Voltage Range		-3		+3	V
IFB1 Regulation Point		760		810	mV
IFB2 Regulation Point		775		825	mV
IFB1, IFB2 Input Bias Current	$-3V < V_{IFB1,2} < 0$	-230			μA
IFB1, IFB2 Lamp-Out Threshold		565		635	mV
IFB1, IFB2 to COMP Transconductance	$0.5V < V_{COMP} < 4V$	60		160	μS
COMP Output Impedance		6		25	$M\Omega$
COMP Discharge Current During Overvoltage or Overcurrent Fault	$V_{VFB} = 2.6V$ or $V_{ISEC} = 1.5V$	500		2000	μA
COMP Discharge Current During DPWM Off-Time	$V_{COMP} = 1.5V$	90		130	μA
ISEC Input Voltage Range		-3		+3	V
ISEC Overcurrent Threshold		1.18		1.26	V
VFB Input Voltage Range		-4		+4	V
VFB Input Impedance		150		450	$M\Omega$
VFB Overvoltage Threshold		2.2		2.4	V
VFB Undervoltage Threshold		210		280	mV
DPWM Oscillator Frequency	$R_{FREQ} = 169k\Omega$	203		217	Hz
PWMO Output Impedance		20		60	$k\Omega$

Low-Cost, SMBus, CCFL Backlight Controller

MAX8759

ELECTRICAL CHARACTERISTICS (continued)

(Circuit of Figure 1, $V_{BATT} = 12V$, $V_{CC} = V_{DD}$, $T_A = -40^{\circ}C$ to $+85^{\circ}C$.) (Note 1)

PARAMETER	CONDITIONS	MIN	TYP	MAX	UNITS
PWMI Input Low Voltage				0.7	V
PWMI Input High Voltage		2.1			V
PWMI Input Frequency Range		5		50	kHz
PWMI Brightness Setting	PWMI duty cycle = 100%	98			%
	PWMI duty cycle = 50%	48		52	
	PWMI duty cycle = 0%	9.7		10.3	
ALS Full-Adjustment Range		0		1.8	V
VALS Output Voltage	MAX8759 is enabled, $6V < V_{BATT} < 28V$, $I_{LOAD} = 1mA$	5.10		5.50	V
VALS On-Resistance	MAX8759 is enabled			60	Ω
Zero-Crossing Delay	$V_{BATT} = 9V$, $R_{THR} = 100k\Omega$	0		0.3	μs
	$V_{BATT} = 12V$, $R_{THR} = 100k\Omega$	1.50		2.10	
Maximum Zero-Crossing Delay	$V_{BATT} = 16V$, $R_{THR} = 100k\Omega$	3.2		4.4	μs
DEL Disable Threshold	DEL rising			4.5	V
	DEL falling	3.9			
TFLT Charge Current	$V_{ISEC} < 1.25V$ and $V_{IFB} < 540mV$; $V_{FLT} = 2V$	0.8		1.2	μA
	$V_{ISEC} < 1.25V$ and $V_{IFB} > 660mV$; $V_{FLT} = 2V$	-1.5		-0.8	
	$V_{ISEC} > 1.25V$ and $V_{IFB} > 660mV$; $V_{FLT} = 2V$	115		155	
TFLT Trip Threshold	Rising edge	3.7		4.3	V
SDA, SCL, Input Low Voltage				0.7	V
SDA, SCL, Input High Voltage		2.1			V
SDA Output Low-Sink Current	$V_{SDA} = 0.4V$	4			mA
SMBus Frequency		10		100	kHz
SMBus Free Time	t_{BUF}	4.7			μs
SCL Serial Clock High Period	t_{HIGH}	4			μs
SCL Serial Clock Low Period	t_{LOW}	4.7			μs
START Condition Setup Time	$t_{SU:STA}$	4.7			μs
START Condition Hold Time	$t_{HD:STA}$	4			μs
STOP Condition Setup Time from SCL	$t_{SU:STO}$	4			μs
SDA Valid to SCL Rising-Edge Setup Time, Slave Clocking in Data	$t_{SU:DAT}$	250			ns
SCL Falling Edge to SDA Transition	$t_{HD:DAT}$	0			ns
SCL Falling Edge to SDA Valid, Reading Out Data	t_{DV}	200			ns

Note 1: Specifications to $-40^{\circ}C$ are guaranteed by design, not production tested.

Low-Cost, SMBus, CCFL Backlight Controller

Typical Operating Characteristics

(Circuit of Figure 1, $V_{IN} = 12V$, $V_{CC} = V_{DD}$, $T_A = +25^\circ C$, unless otherwise noted.)

MAX8759

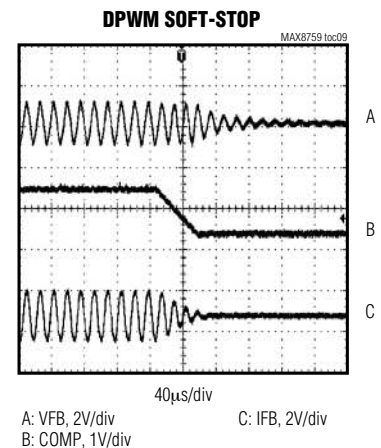
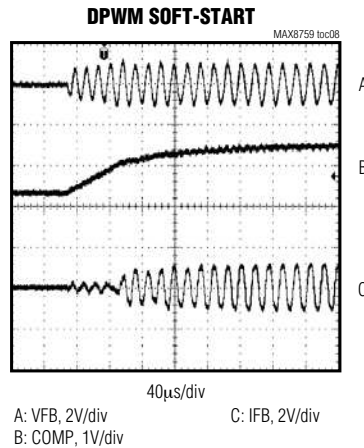
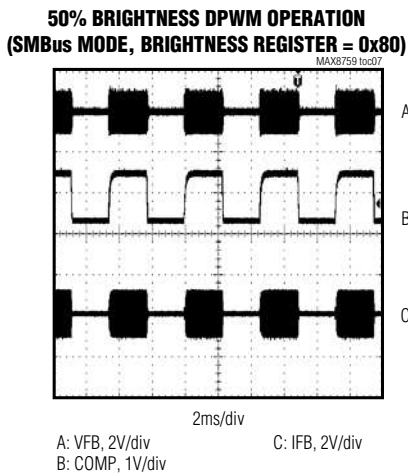
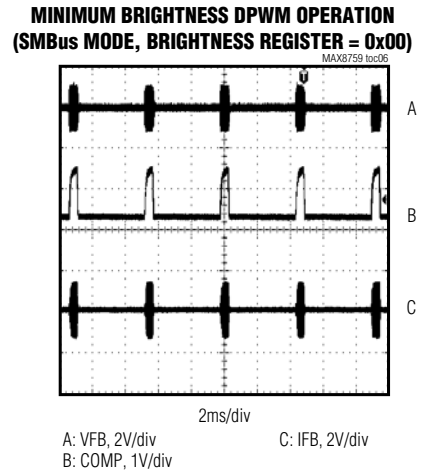
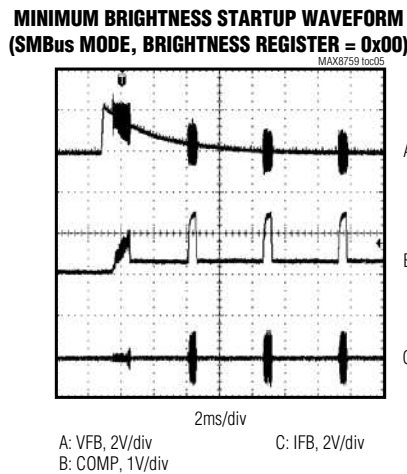
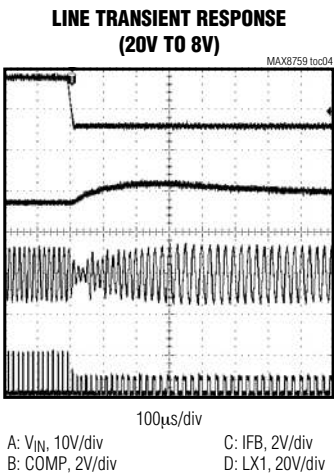
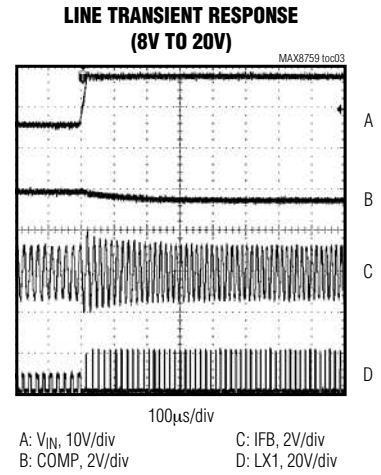
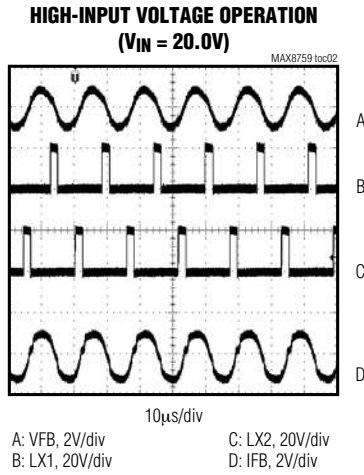
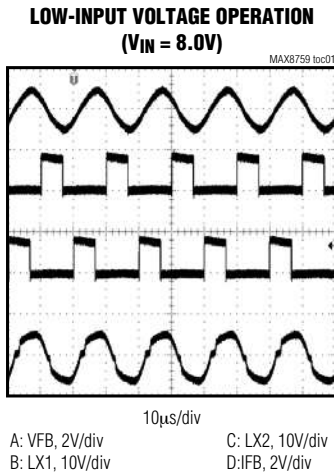

Low-Cost, SMBus, CCFL Backlight Controller

Typical Operating Characteristics (continued)

(Circuit of Figure 1, $V_{IN} = 12V$, $V_{CC} = V_{DD}$, $T_A = +25^{\circ}C$, unless otherwise noted.)

OPEN-LAMP VOLTAGE LIMITING AND TIMEOUT

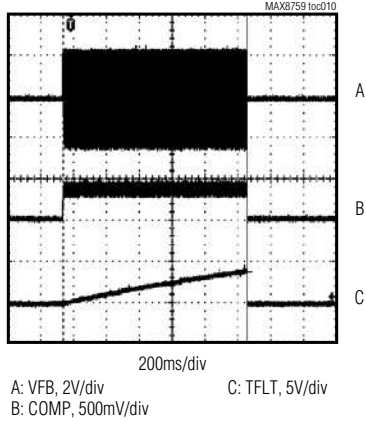

SECONDARY SHORT-CIRCUIT PROTECTION AND TIMEOUT

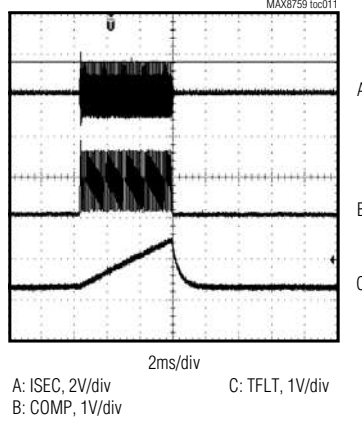

SWITCHING FREQUENCY vs. INPUT VOLTAGE

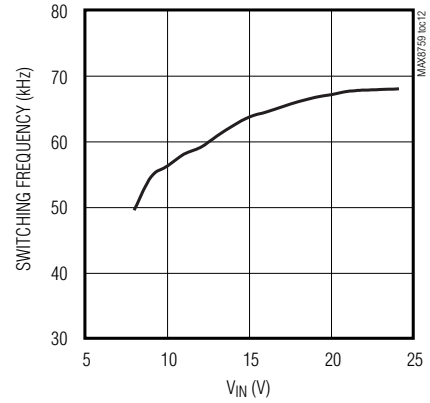

DPWM FREQUENCY vs. R_{FREQ}

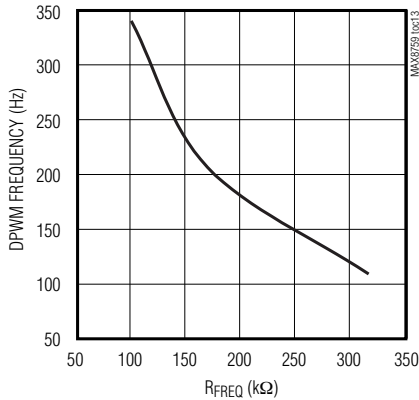

RMS LAMP CURRENT vs. INPUT VOLTAGE

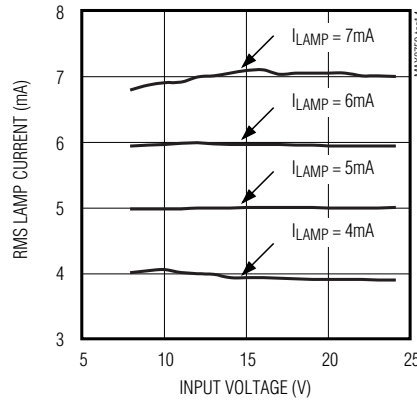

RMS LAMP CURRENT (I_{LAMP} = 6mA) vs. INPUT VOLTAGE

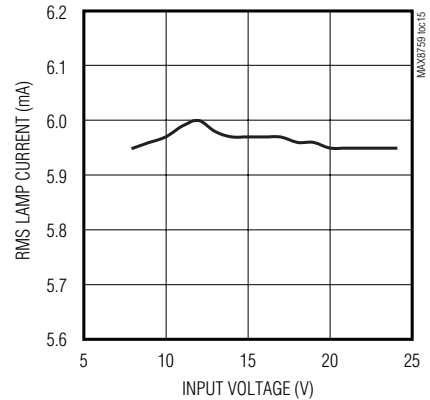

NORMALIZED BRIGHTNESS vs. SMBus BRIGHTNESS SETTING

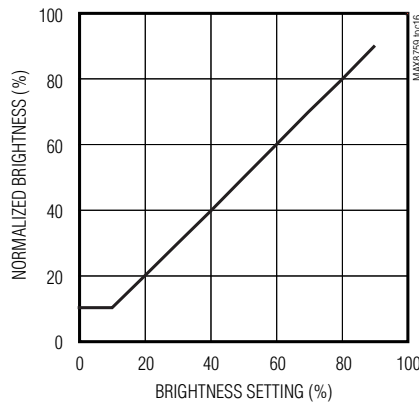

NORMALIZED BRIGHTNESS vs. PWM DUTY CYCLE

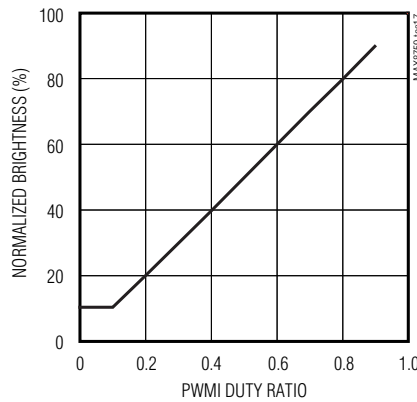

NORMALIZED BRIGHTNESS vs. ALS VOLTAGE

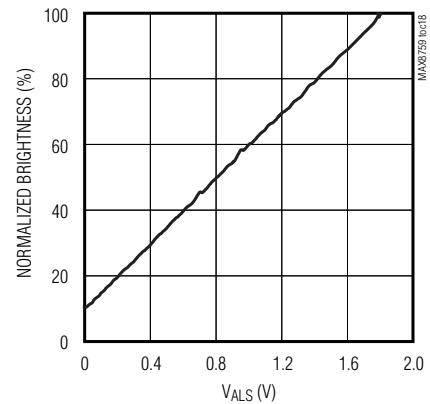

Low-Cost, SMBus, CCFL Backlight Controller

MAX8759

Typical Operating Characteristics (continued)

(Circuit of Figure 1, $V_{IN} = 12V$, $V_{CC} = V_{DD}$, $T_A = +25^\circ C$, unless otherwise noted.)

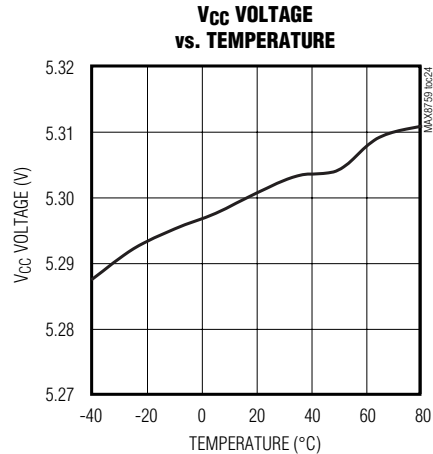
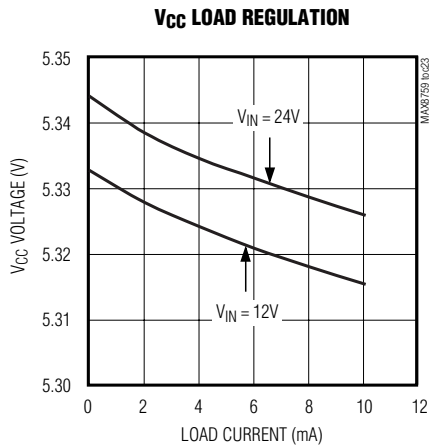
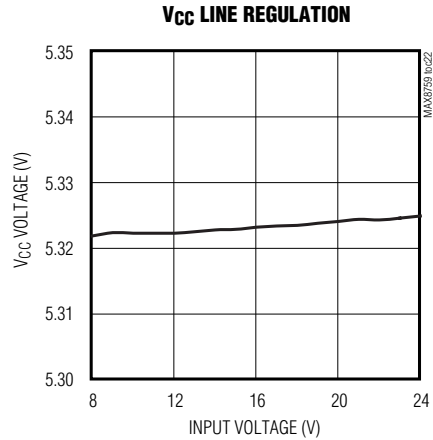
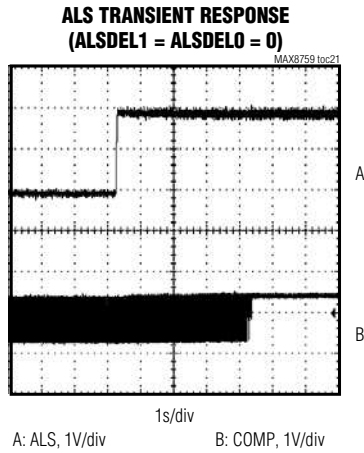
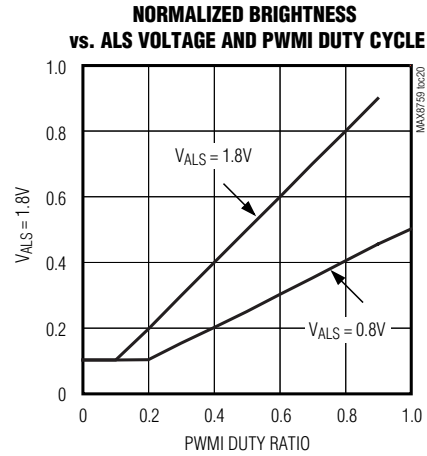
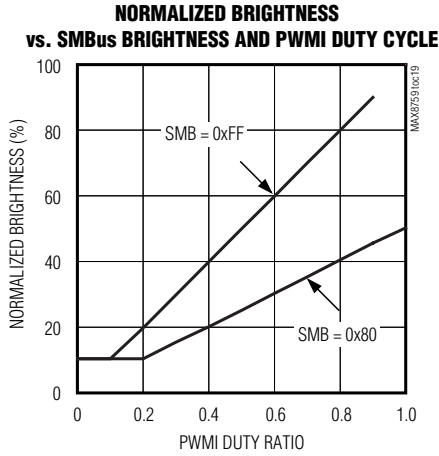

Low-Cost, SMBus, CCFL Backlight Controller

Pin Description

PIN	NAME	FUNCTION
1	BATT	Supply Input. BATT is the input to the internal 5.35V linear regulator that powers the device. Bypass BATT to GND with a 0.1 μ F ceramic capacitor.
2	SDA	SMBus Serial Data Input
3	SCL	SMBus Serial Clock Input
4	TFLT	Fault-Timer Adjustment Pin. Connect a capacitor from TFLT to GND to set the time-out periods for open-lamp and secondary overcurrent faults.
5	VALS	Ambient-Light-Sensor Supply Pin. Bypass VALS to GND with a 0.1 μ F capacitor.
6	ALS	Ambient-Light-Sensor Input
7	PWMI	DPST Control Input
8	PWMO	DPST Buffer Output. Connect a capacitor between PWMO and GND. The capacitor forms a lowpass filter with an internal 40k Ω (typ) resistor for filtering the DPST signal.
9	FREQ	Chopping-Frequency Adjustment Pin. Connect a resistor from FREQ to GND to set the DPWM frequency: $f_{DPWM} = 210\text{Hz} \times 169\text{k}\Omega / R_{FREQ}$.
10	COMP	Transconductance Error Amplifier Output. A compensation capacitor connected between COMP and GND sets the rise and fall time of the lamp-current envelope in DPWM operation.
11	DEL	Adaptive Zero-Crossing-Delay Adjustment Pin. Connect a resistor between DEL and GND to adjust the range of the zero-crossing delay. Connecting DEL to V _{CC} disables the zero-crossing delay function.
12	IFB1	Lamp-Current-Feedback Input. The IFB1 sense signal is internally full-wave rectified. IFB1 is compared with IFB2 and the larger is used for lamp-current regulation. The average value of the rectified signal is regulated to 785mV (typ) by controlling the on-time of high-side switch. An open-lamp fault is generated if the peak voltage of IFB1 is below 600mV for a fault delay period set by TFLT.
13	IFB2	Lamp-Current-Feedback Input. The IFB2 sense signal is internally full-wave rectified. IFB1 is compared with IFB2 and the larger is used for lamp-current regulation. The average value of the rectified signal is regulated to 800mV (typ) by controlling the on-time of high-side switch. An open-lamp fault is generated if the peak voltage of IFB2 is below 600mV for a fault-delay period set by TFLT. IFB2 input can be disabled by connecting IFB2 to V _{CC} .
14	VFB	Transformer Secondary Voltage-Feedback Input. A capacitive voltage-divider between the high-voltage terminal of the CCFL tube and GND sets the maximum average lamp voltage during striking and lamp-out fault. When the peak voltage on VFB exceeds the internal overvoltage threshold, the controller turns on an internal current sink, discharging the COMP capacitor to limit the switch on-time. The VFB pin is also used to detect a secondary undervoltage condition. If the peak voltage on VFB is below 230mV continuously for 250 μ s during the DPWM ON period, the MAX8759 shuts down.
15	ISEC	Transformer Secondary Current-Feedback Input. A current-sense resistor connected between the low-voltage end of the transformer secondary and the ground sets the maximum secondary current during short-circuit fault. When the peak voltage on ISEC exceeds the internal overcurrent threshold, the controller turns on an internal current sink discharging the COMP capacitor.
16	LX1	GH1 Gate-Driver Return. LX1 is the input to the current-limit and zero-crossing comparators. The device senses the voltage across the low-side MOSFET NL1 to detect primary current zero crossing and primary overcurrent.
17	GH1	High-Side MOSFET NH1 Gate Driver Output

Low-Cost, SMBus, CCFL Backlight Controller

Pin Description (continued)

PIN	NAME	FUNCTION
18	BST1	GH1 Gate-Driver Supply Input. Connect a 0.1 μ F capacitor from LX1 to BST1.
19	PGND1	Power Ground. PGND1 is the return for the GL1 gate driver.
20	GL1	Low-Side MOSFET NL1 Gate Driver Output
21	V _{DD}	Low-Side Gate-Driver Supply Input. Connect V _{DD} to the output of the internal linear regulator (V _{CC}).
22	GL2	Low-Side MOSFET NL2 Gate-Driver Output
23	PGND2	Power Ground. PGND2 is the return for the GL2 gate driver.
24	BST2	GH2 Gate-Driver Supply Input. Connect a 0.1 μ F capacitor from LX2 to BST2.
25	GH2	High-Side MOSFET NH2 Gate-Driver Output
26	LX2	GH2 Gate-Driver Return. LX2 is the input to the current-limit and zero-crossing comparators. The device senses the voltage across the low-side MOSFET NL2 to detect primary current zero crossing and primary overcurrent.
27	GND	Analog Ground. The ground return for V _{CC} , REF, and other analog circuitry. Connect GND to PGND under the IC at the IC's backside exposed metal pad.
28	V _{CC}	5.35V/10mA Internal Linear-Regulator Output. V _{CC} is the supply voltage for the device. Bypass V _{CC} with a 0.47 μ F ceramic capacitor to GND.
—	EP	Exposed Backside Pad. Connect PAD to GND.

MAX8759

Low-Cost, SMBus, CCFL Backlight Controller

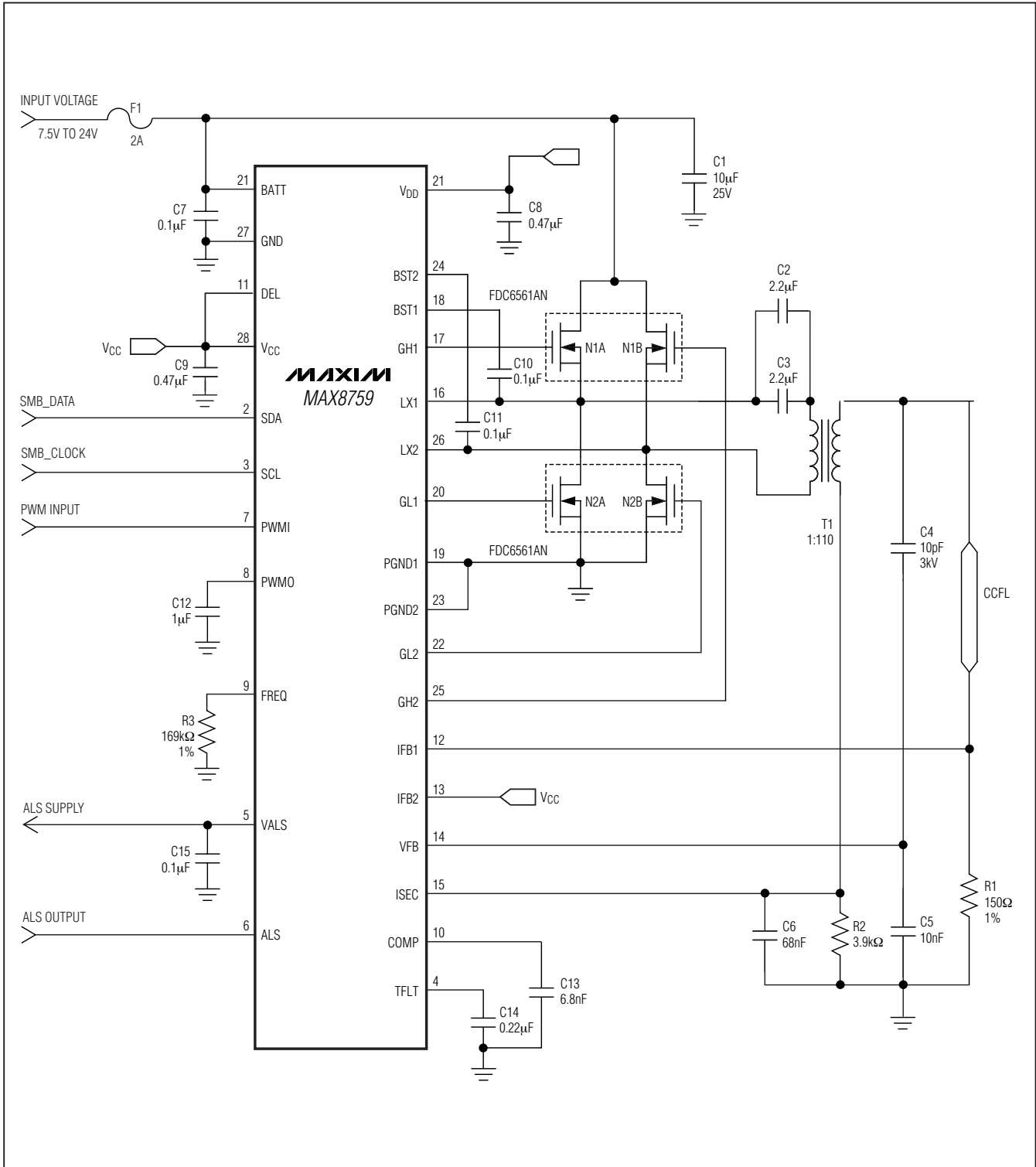

Figure 1. Typical MAX8759 Single-Lamp Operating Circuit

Low-Cost, SMBus, CCFL Backlight Controller

Typical Operating Circuit

The MAX8759 typical operating circuit (Figure 1) is a single-lamp CCFL backlight inverter for notebook computer TFT LCD panels. The input voltage range of the circuit is from 7.5V to 24V. The maximum RMS lamp current is set to 6mA and the maximum RMS striking voltage is set to 1800V. Table 1 lists some important components and Table 2 lists the component suppliers' contact information.

Detailed Description

The MAX8759 controls a full-bridge resonant inverter to convert an unregulated DC input into a high-frequency AC output for powering CCFLs. The resonant operation maximizes striking capability and provides near-sinu-

soidal waveforms over the entire input range to improve CCFL lifetime. The lamp brightness is adjusted by turning the lamp on and off with a DPWM signal. The DPWM frequency can be accurately adjusted with a resistor. The brightness of the lamp is proportional to the duty cycle of the DPWM signal, which is controlled either with a 2-wire SMBus-compatible interface, with an external ALS, or with an external PWM signal. The device also includes safety features that effectively protect against single-point fault conditions such as lamp-out and secondary short-circuit faults. An internal 5.35V linear regulator powers the MOSFET drivers and most of the internal circuitry. Figure 2 is the functional diagram of the MAX8759 and Figure 3 is the detailed diagram of the SMBus and ALS input block.

Resonant Operation

The MAX8759 drives four n-channel power MOSFETs that make up the zero-voltage-switching (ZVS) full-bridge inverter as shown in Figure 4. Assume that NH1 and NL2 are on at the beginning of a switching cycle as shown in Figure 4(a). The primary current flows through MOSFET NH1, DC blocking capacitor C2, the primary side of transformer T1, and MOSFET NL2. During this interval, the primary current ramps up until the controller turns off NH1. When NH1 is turned off, the primary current forward biases the body diode of NL1, which clamps the LX1 voltage just below ground as shown in Figure 4(b). When the controller turns on NL1, its drain-to-source voltage is near zero because its forward-biased body diode clamps the drain. Since NL2 is still on, the primary current flows through NL1, C2, the primary side of T1, and NL2. Once the primary current drops to the minimum current threshold ($6\text{mV}/R_{\text{DS(ON)}}$), the controller turns off NL2. The remaining energy in T1 charges up the LX2 node until the body diode of NH2 is forward biased. When NH2 turns on, it does so with near-zero drain-to-source voltage. The primary current reverses polarity as shown in Figure 4(c), beginning a new cycle with the current flowing in the opposite direction, with NH2 and NL1 on. The primary current ramps up until the controller turns off NH2. When NH2 is turned off, the primary current forward biases the body diode of NL2, which clamps the LX2 voltage just below ground as shown in Figure 4(d). After the LX2 node goes low, the controller losslessly turns on NL2. Once the primary current drops to the minimum current threshold, the controller turns off NL1. The remaining energy charges up the LX1 node until the body diode of NH1 is forward biased. Finally, NH1 losslessly turns on, beginning a new cycle as shown in Figure 4(a). Note that switching transitions on all four power MOSFETs occur under ZVS conditions, which reduces transient power losses and EMI.

Table 1. List of Important Components

DESIGNATION	DESCRIPTION
C1	10 μF $\pm 20\%$, 25V X5R ceramic capacitor (1210) Murata GRM32DR61E106M TDK C3225X5R1E106M
C2, C3	2.2 μF $\pm 10\%$, 25V X5R ceramic capacitors (0805) Murata GRM21BR61E225K TDK C2012X5R1E225K
C4	10pF $\pm 10\%$, 3kV HV ceramic capacitor (1808) Kemet C1808C100KHGAC TDK C4520C0G3F100F
NH1/2, NL1/2	Dual n-channel MOSFETs, 30V, 0.095 Ω , 6-pin SOT23 Fairchild FDC6561AN
T1	CCFL transformer, 1:110 turns ratio TMP UI9.8L type

Table 2. Component Suppliers

SUPPLIER	WEBSITE
Fairchild Semiconductor	www.fairchildsemi.com
Kemet	www.kemet.com
Murata	www.murata.com
TDK	www.components.tdk.com
TMP	www.tmp.com

Low-Cost, SMBus, CCFL Backlight Controller

MAX8759

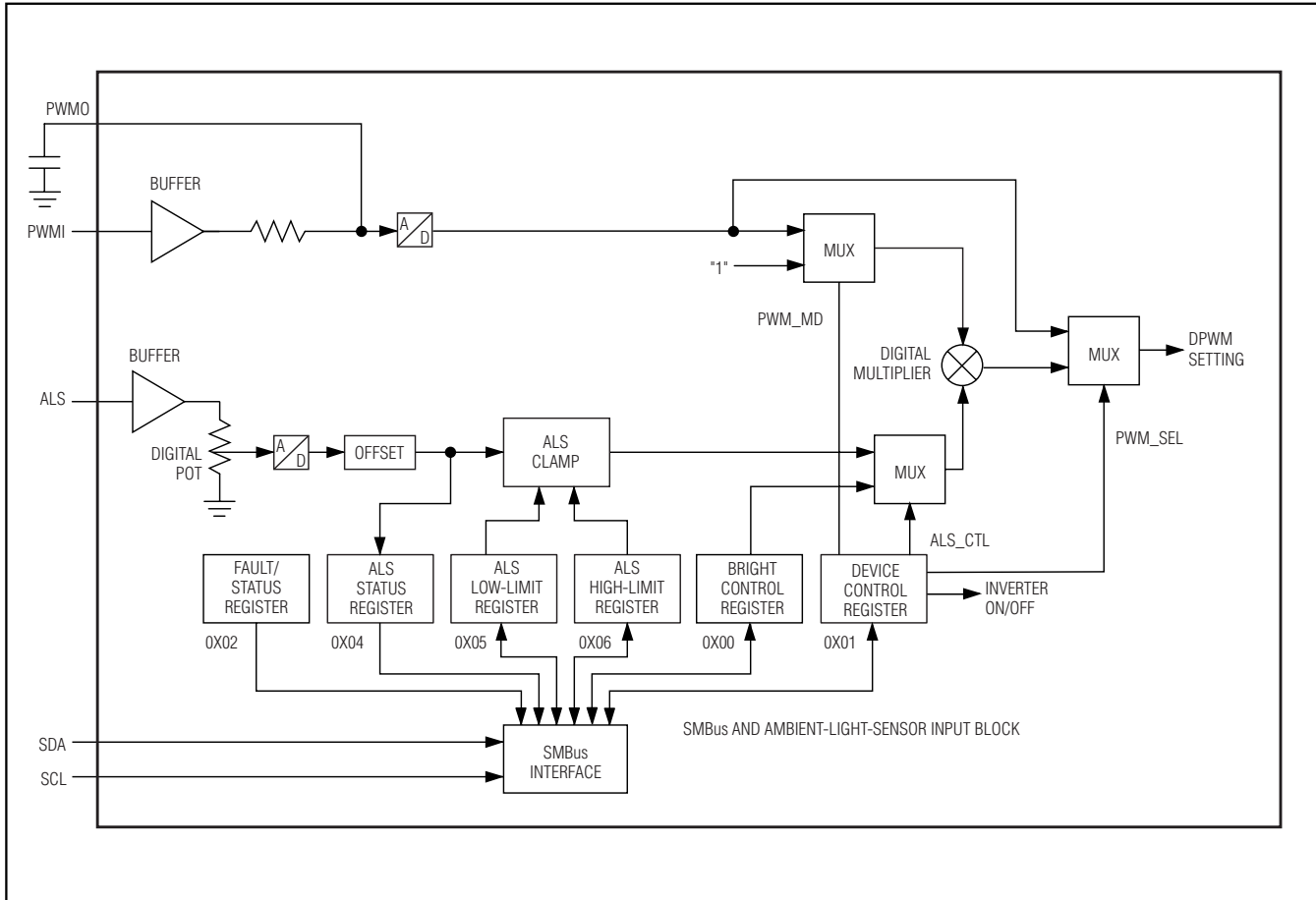

Figure 3. MAX8759 SMBus and Ambient-Light-Sensor Input Block

A simplified CCFL inverter circuit is shown in Figure 5 (a). The full-bridge power stage is simplified and represented as a square-wave AC source. The resonant tank circuit can be further simplified to Figure 5(b) by removing the transformer. C_S is the primary series capacitor, C_S' is the series capacitance reflected to the secondary, C_P is the secondary parallel capacitor, N is the transformer turns ratio, L is the transformer secondary leakage inductance, and R_L is an idealized resistance that models the CCFL in normal operation.

Figure 6 shows the frequency response of the resonant tank's voltage gain under different load conditions. The primary series capacitor is $1\mu\text{F}$, the secondary parallel capacitor is 15pF , the transformer turns ratio is 1:93, and the secondary leakage inductance is 260mH . Notice that there are two peaks, f_S and f_P , in the frequency response. The first peak f_S is the series resonant peak determined by the secondary leakage inductance (L) and the series capacitor reflected to the secondary ($C'S$):

$$f_S = \frac{1}{2\pi\sqrt{LC'S}}$$

Low-Cost, SMBus, CCFL Backlight Controller

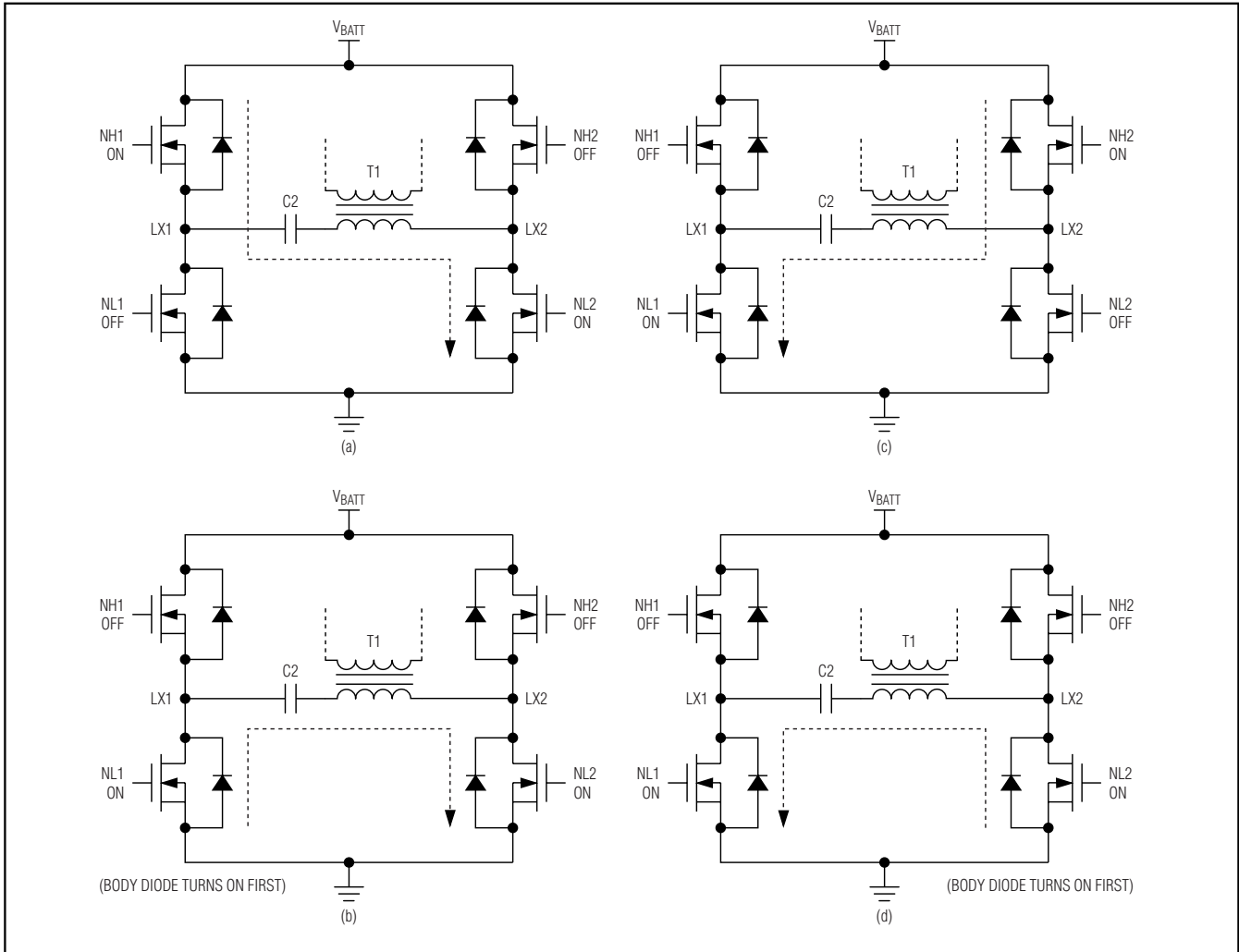

Figure 4. Resonant Operation

The second peak f_p is the parallel resonant peak determined by the secondary leakage inductance (L), the parallel capacitor (C_p), and the series capacitor reflected to the secondary (C_s):

$$f_p = \frac{1}{2\pi \sqrt{L \frac{C_s C_p}{C_s + C_p}}}$$

The inverter is designed to operate between these two resonant peaks. When the lamp is off, the operating point of the resonant tank is close to the parallel resonant peak due to the lamp's infinite impedance. The circuit displays the characteristics of a parallel-loaded

resonant converter. While in parallel-loaded resonant operation, the inverter behaves like a voltage source to generate the necessary striking voltage. Theoretically, the output voltage of the resonant converter increases until the lamp is ionized or until it reaches the IC's secondary voltage limit. Once the lamp is ionized, the equivalent load resistance decreases rapidly and the operating point moves toward the series resonant peak. While in series resonant operation, the inverter behaves like a current source.

Lamp-Current Regulation

The MAX8759 uses a lamp-current control loop to regulate the current delivered to the CCFL. The heart of the control loop is a transconductance error amplifier. The

Low-Cost, SMBus, CCFL Backlight Controller

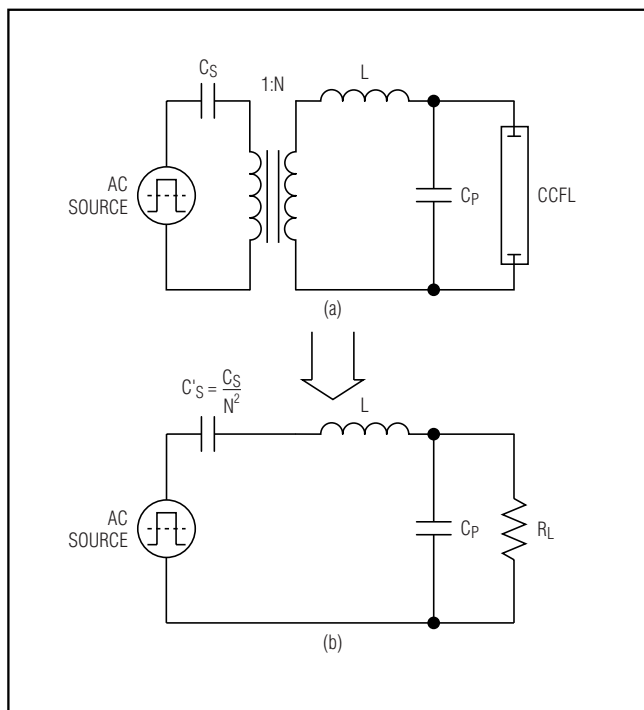

Figure 5. Equivalent Resonant Tank Circuit

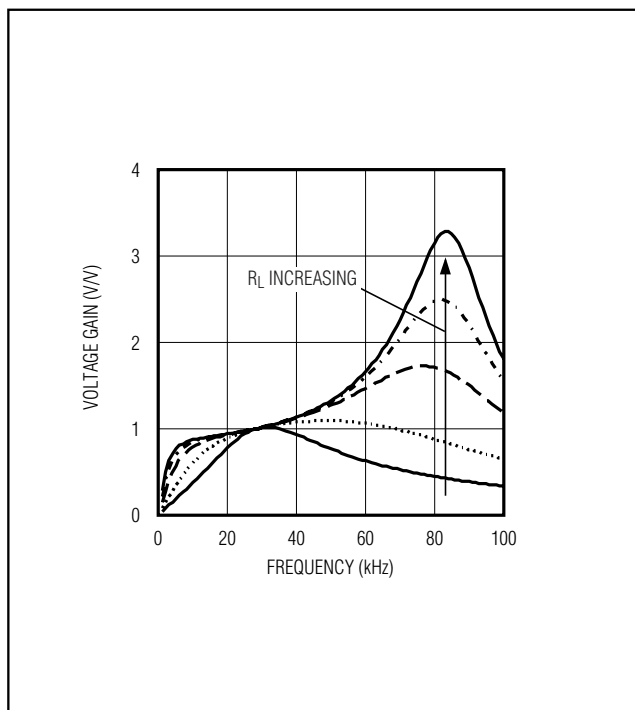

Figure 6. Frequency Response of the Resonant Tank

AC lamp current is sensed with a resistor connected in series with the low-voltage terminal of the lamp. The MAX8759 has two lamp-current feedback inputs (IFB1 and IFB2) to support dual-lamp application. The voltages across the sense resistors are fed to the IFB1 and IFB2 inputs and are internally full-wave rectified. The transconductance error amplifier selects the higher one of the two feedback signals and compares the rectified voltage with an internal threshold to generate an error current. The error current charges and discharges a capacitor connected between COMP and ground to create an error voltage (VCOMP). VCOMP is then compared with an internal ramp signal to set the high-side MOSFET switch on-time (tON).

Feed-Forward Control

The MAX8759 is designed to maintain tight control of the lamp current under all transient conditions. The feed-forward control instantaneously adjusts the on-time for changes in input voltage (VBATT). This feature provides immunity to input-voltage variations and simplifies loop compensation over wide input-voltage ranges. The feed-forward control also improves the line regulation for short DPWM on-times and makes startup transients less dependent on the input voltage.

Feed-forward control is implemented by increasing the internal voltage ramp rate for higher VBATT. This has the effect of varying tON as a function of the input voltage while maintaining approximately the same signal levels at VCOMP. Since the required voltage change across the compensation capacitor is minimal, the controller's response to input voltage changes is essentially instantaneous.

Lamp Startup

A CCFL is a gas-discharge lamp that is normally driven in the avalanche mode. To start ionization in a nonionized lamp, the applied voltage (striking voltage) must be increased to the level required for the start of avalanche. At low temperatures, the striking voltage can be several times the typical operating voltage.

Because of the MAX8759's resonant topology, the striking voltage is guaranteed. Before the lamp is ionized, the lamp impedance is infinite. The transformer secondary leakage inductance and the high-voltage parallel capacitor determine the unloaded resonant frequency. Since the unloaded resonant circuit has a high Q, it can generate very high voltage across the lamp.

Low-Cost, SMBus, CCFL Backlight Controller

Dimming Control

The MAX8759 controls the brightness of the CCFL by “chopping” the lamp current on and off using a low-frequency (between 100Hz and 350Hz) DPWM signal. The frequency of the internal DPWM oscillator is adjustable through a resistor connected between the FREQ pin and GND. The CCFL brightness is proportional to the DPWM duty cycle, which can be adjusted from 10.15% to 100%.

In DPWM operation, the COMP voltage controls the dynamics of the lamp-current envelope. At the beginning of the DPWM ON cycle, the average value of the lamp-current feedback signal is below the regulation point, so the transconductance error amplifier sources current into the COMP capacitor. The switch on-time (t_{ON}) gradually increases as V_{COMP} rises, which provides soft-start. At the end of the DPWM ON cycle, the MAX8759 turns on a 110 μ A internal current source. The current source linearly discharges the COMP capacitor, gradually decreasing t_{ON} , and providing soft-stop.

The DPWM frequency can be set with an external resistor. Connect a resistor between FREQ and GND. The DPWM frequency is given by the following equation:

$$f_{DPWM} = 210\text{Hz} \times 169\text{k}\Omega / R_{FREQ}$$

The adjustable range of the DPWM frequency is between 100Hz and 350Hz (R_{FREQ} is between 100k Ω and 350k Ω).

The MAX8759 has three ways for brightness control. The brightness can be controlled by a 2-wire serial interface (SMBus), by an external PWM signal, or by an external ambient-light sensor signal. There are five operating modes, which can be selected by setting bits 1 to 3 in device control register 0x01 (see the *SMBus Register Definitions* section for details).

ALS Mode

The MAX8759 can work with several types of ambient-light sensors. The ideal ambient-light sensors should have a linear response to ambient light and should have a spectral response equivalent to that of the human eye. Ambient-light sensors must provide filtering of low-frequency harmonics found in the electrical spectrum of the many light sources. The ALS's output should be a DC analog voltage that is linearly proportional to the ambient luminance.

In ALS mode, the MAX8759 sets the brightness based on the analog voltage on the ALS pin. The ALS pin is connected to the output of an external ambient-light sensor. The usable input-voltage range of the ALS pin

is 0 to 1.8V. The MAX8759 compares the ALS input voltage against user-programmable low and high limits. When the ALS input voltage is below the low limit, the brightness is clamped to the ALS low limit. When the ALS input voltage is above the high limit, the brightness is clamped to the ALS high limit. If the minimum ALS setting is below 10%, the brightness is clamped to 10%. Figure 7 shows the brightness change as a function of the ALS voltage.

The ALS input voltage is sampled every DPWM period and is loaded in ALS status register 0x04. The analog voltage on the ALS pin is converted into an 8-bit digital code. The total number of brightness levels is 256. One step change results in a 0.391% change in the DPWM duty cycle.

PWM Mode

In PWM mode, the MAX8759 sets the brightness based on the duty cycle of the PWMI signal. The absolute minimum brightness is 10%. If the PWMI duty cycle is less than 10%, the brightness stays at 10%. The frequency range of the PWMI signal is between 5kHz and 50kHz when the PWMO capacitor is 1 μ F.

SMBus Mode

In SMBus mode, the MAX8759 sets the brightness based on the brightness control register (0x00). The brightness control register contains 8 bits and supports 256 brightness levels. A setting of 0xFF for register 0x00 sets the inverter to the maximum brightness. A setting of 0x00 for register 0x00 sets the inverter to the minimum brightness (10%).

ALS with DPST Mode

In ALS with DPST mode, the MAX8759 sets the brightness based on the analog voltage on the ALS pin and duty cycle at the PWMI pin. The MAX8759 lowers the ALS brightness setting by an additional amount that is proportional to the duty cycle of the PWMI signal. For example, if the ALS brightness setting is 80% and the duty cycle of PWMI signal is 60%, the resulting brightness setting is 80% x 60% = 48%.

SMBus with DPST Mode

In SMBus with DPST mode, the MAX8759 sets the brightness based on the brightness control register (0x00). The MAX8759 lowers the SMBus brightness setting by an additional amount that is proportional to the duty cycle of the PWMI signal. For example, if the brightness control register is set to 0x80 (corresponding to 50% brightness setting) and the duty cycle of the PWMI signal is 60%, the resulting brightness setting is 50% x 60% = 30%.

Low-Cost, SMBus, CCFL Backlight Controller

Fault Protections

Lamp-Out Protection

For safety, the MAX8759 monitors the lamp-current feedback inputs (IFB1 and IFB2) to detect faulty or open CCFL tubes. As described in the *Lamp-Current Regulation* section, the voltage on IFB1 and IFB2 is internally full-wave rectified. If the rectified IFB1 or IFB2 voltage is below 600mV, the MAX8759 charges the TFLT capacitor with 1 μ A. The MAX8759 sets the fault latch and the device is shut down when the voltage on TFLT exceeds 4V. Unlike the normal shutdown mode, the linear regulator output (V_{CC}) remains at 5.35V. Clearing bit 0 of the device control register (0x01) or cycling the input power clears the fault latch.

During the fault-delay period, the current control loop tries to maintain the lamp-current regulation by increasing the high-side MOSFET on-time. Because the lamp impedance is very high when it is open, the transformer secondary voltage rises as a result of the high Q-factor of the resonant tank. Once the secondary voltage exceeds the overvoltage threshold, the MAX8759 turns on a 1000 μ A current source that discharges the COMP capacitor. The on-time of the high-side MOSFET is reduced, lowering the secondary voltage as the COMP voltage decreases. Therefore, the peak voltage of the transformer secondary winding never exceeds the limit during the lamp-out delay period.

Primary Overcurrent Protection

The MAX8759 senses primary current in each switching cycle. When the regulator turns on the low-side MOSFET, a comparator monitors the voltage drop from LX_ to PGND_. If the voltage exceeds the current-limit threshold (430mV, typ), the regulator immediately turns off the high-side switch to prevent the transformer primary current from increasing further.

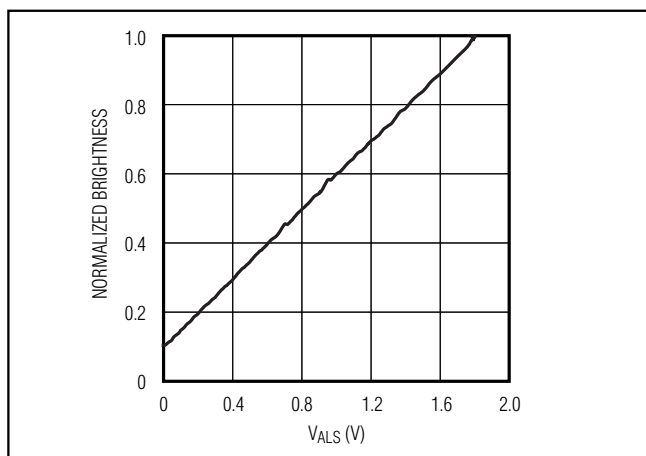

Figure 7. Normalized Brightness vs. ALS Voltage

Secondary Voltage Limiting (VFB)

The MAX8759 reduces the voltage stress on the transformer's secondary winding by limiting the secondary voltage during startup and open-lamp faults. The AC voltage across the transformer secondary winding is sensed through a capacitive voltage-divider formed by C4 and C5 in Figure 1. The voltage across C5 is fed to the VFB input. An overvoltage comparator compares the VFB peak voltage with a 2.3V (typ) internal threshold. Once the VFB peak voltage exceeds the overvoltage threshold, the MAX8759 turns on an internal 1000 μ A current source that discharges the COMP capacitor. The high-side MOSFET's on-time shortens as the COMP voltage decreases, limiting the transformer secondary's peak voltage at the threshold determined by the capacitive voltage-divider.

Secondary Undervoltage Protection (VFB)

The MAX8759 senses the VFB voltage for undervoltage condition. During the DPWM ON period, if the VFB voltage is below the undervoltage threshold (230mV, typ) continuously for an internal delay period (250 μ s typ, for RFREQ = 169k Ω), the MAX8759 shuts down.

Secondary Current Limit (ISEC)

The secondary current limit provides fail-safe current limiting in case of a short circuit or leakage from the lamp high-voltage terminal to ground that prevents the current control loop from functioning properly. ISEC monitors the voltage across a sense network placed between the transformer's low-voltage secondary terminal and ground. The ISEC voltage is continuously compared to the ISEC regulation threshold (1.21V, typ). Any time the ISEC voltage exceeds the threshold, the MAX8759 turns on a 1000 μ A current source that discharges the COMP capacitor, reducing the on-time of the high-side switches. At the same time, the MAX8759 charges the TFLT capacitor with a 135 μ A current. The MAX8759 sets the fault latch and shuts down when the voltage on TFLT exceeds 4V. Clearing bit 0 of the device control register (0x01) or cycling the input power clears the fault latch.

Linear Regulator Output (V_{CC})

The internal linear regulator steps down the DC input voltage at BATT pin to 5.35V (typ). The linear regulator supplies power to the internal control circuitry of the MAX8759 and is also used to power the MOSFET drivers by connecting V_{CC} to V_{DD}. The V_{CC} voltage drops to 4.5V in shutdown.

POR and UVLO

The MAX8759 includes power-on reset (POR) and undervoltage lockout (UVLO) features. POR resets the fault latch and sets all the SMBus registers to their POR

Low-Cost, SMBus, CCFL Backlight Controller

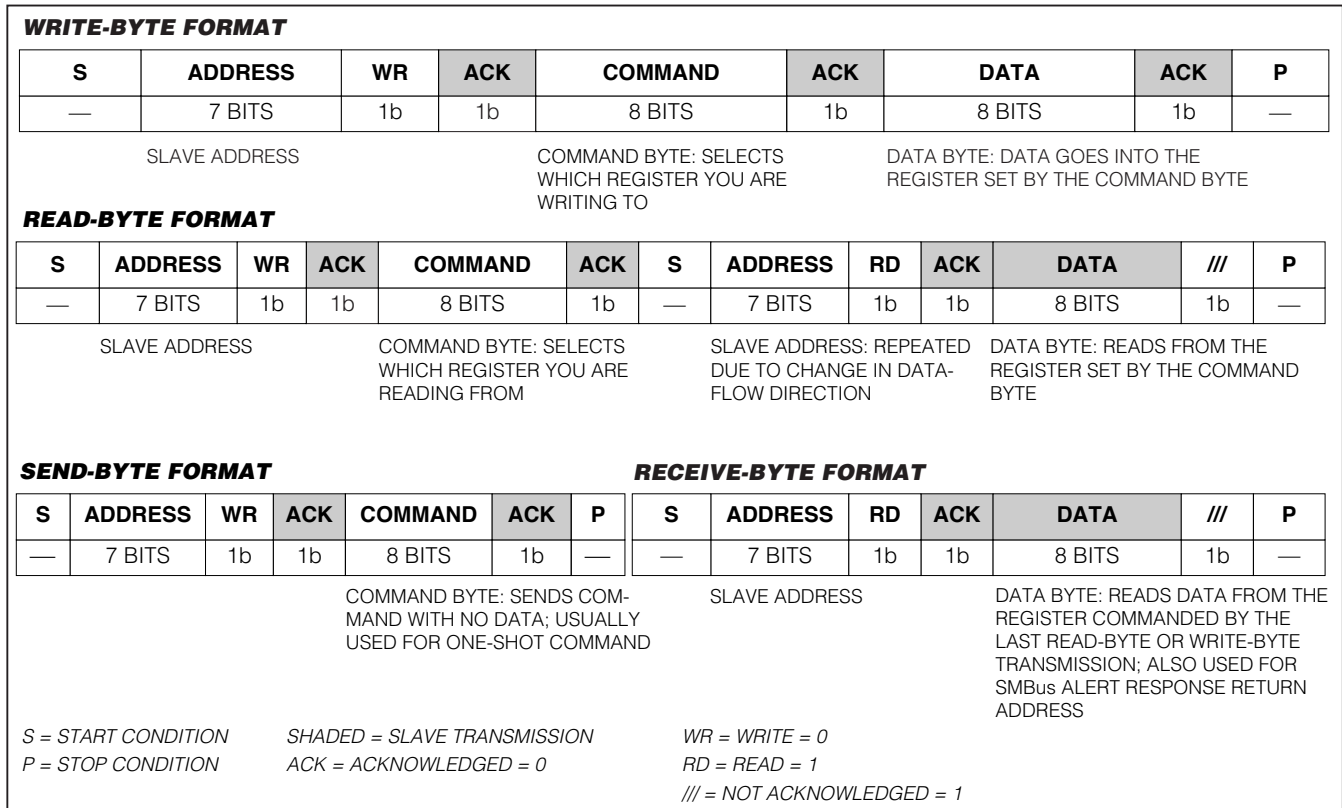

Figure 8. SMBus Protocols

values. POR occurs when V_{CC} rises above 1.75V (typ). The UVLO occurs when V_{CC} is below 4.2V (typ). The MAX8759 disables both high-side and low-side switch drivers below the UVLO threshold.

Low-Power Shutdown

The MAX8759 is placed into shutdown by clearing bit 0 of the device control register (0x01). When the MAX8759 is shut down, all functions of the IC are turned off except the 5.35V linear regulator. In shutdown, the linear regulator output voltage drops to 4.5V and the supply current is 6 μ A (typ). While in shutdown, the fault latch is reset. The device can be reenabled by setting bit 0 of the device control register to 1.

Ambient-Light-Sensor Supply Pin (VALS)

The MAX8759 provides the supply voltage of the ALS through the VALS pin. VALS is internally connected to the 5.35V linear regulator output through a p-channel MOSFET. The p-channel MOSFET is turned on when the MAX8759 is enabled and turned off when the part is disabled. Bypass VALS to ground with a minimum 0.1 μ F ceramic capacitor. Place the capacitor as close to the ALS supply input as possible.

SMBus Interface (SDA, SCL)

The MAX8759 supports an SMBus-compatible 2-wire digital interface. SDA is the bidirectional data line and SCL is the clock line of the 2-wire interface corresponding respectively to SMBDATA and SMBCLK lines of the SMBus. SDA and SCL have Schmidt-triggered inputs that can accommodate slow edges; however, the rising and falling edges should still be faster than 1 μ s and 300ns, respectively. The MAX8759 uses the write-byte and read-byte protocols (Figure 8). The SMBus protocols are documented in *System Management Bus Specification V1.08* and are available at <http://www.sbs-forum.org/>.

The MAX8759 is a slave-only device and responds to the 7-bit address 0b0101100. The read and write commands can be distinguished by adding ONE more bit (R/W bit) to the end of the 7-bit slave address, with one indicating read and zero indicating write. The MAX8759 has seven registers: a brightness control register (0x00), a device control register (0x01), a fault/status register (0x02), an identification register (0x03), an ALS status register (0x04), an ALS low-limit register (0x05),

Low-Cost, SMBus, CCFL Backlight Controller

MAX8759

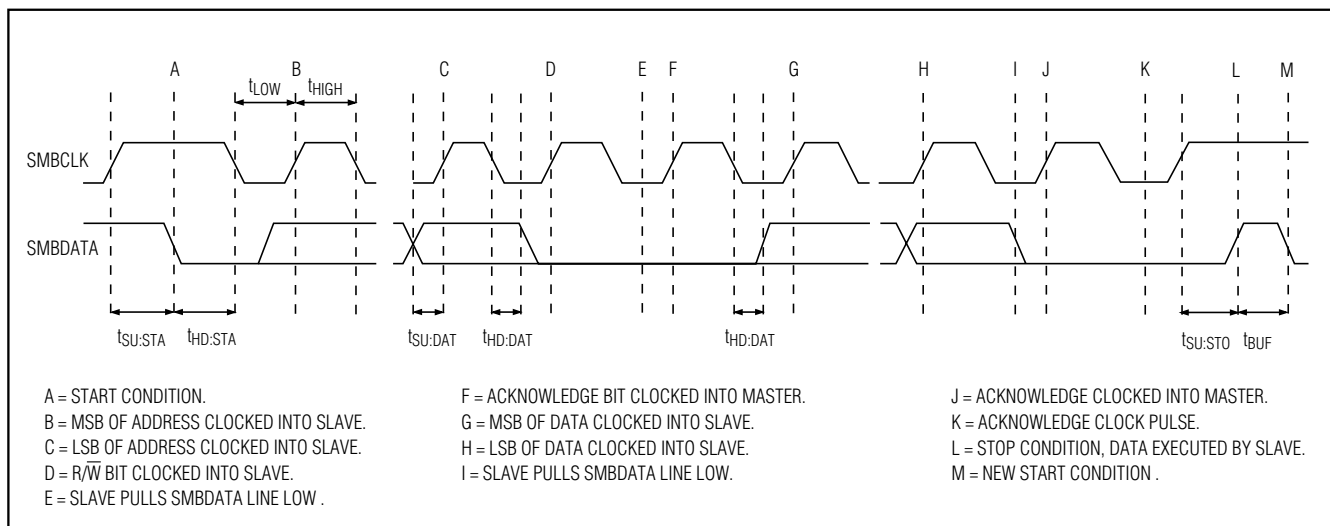

Figure 9. SMBus Write Timing

and an ALS high-limit register (0x06). The MAX8759 only acknowledges these seven registers.

Communication starts with the master signaling the beginning of a transmission with a START condition, which is a high-to-low transition on SDA while SCL is high. When the master has finished communicating with the slave, the master issues a STOP condition, which is a low-to-high transition on SDA while SCL is high. The bus is then free for another transmission. Figures 9 and 10 show the timing diagrams for signals on the 2-wire interface. The address byte, command byte, and data byte are transmitted between the START and STOP conditions. The SDA state is allowed to change only while SCL is low, except for the START and STOP conditions. Data is transmitted in 8-bit words and is sampled on the rising edge of SCL. Nine clock cycles are required to transfer each byte in or out of the MAX8759 since either the master or the slave acknowledges the receipt of the correct byte during the ninth clock. If the MAX8759 receives its correct slave

address followed by $R/\overline{W} = 0$, it expects to receive 1 or 2 bytes of information (depending on the protocol). If the device detects a START or STOP condition prior to clocking in the bytes of data, it considers this an error condition and disregards all the data. If the transmission is completed correctly, the registers are updated immediately after a STOP (or RESTART) condition. If the MAX8759 receives its correct slave address followed by $R/\overline{W} = 1$, it expects to clock out the register data selected by the previous command byte.

SMBus Register Definitions

All MAX8759 registers are byte wide and accessible through the read/write byte protocols mentioned in the previous section. Their bit assignments are provided in the following sections with reserved bits containing a default value of zero.

Table 3 summarizes the register assignments, as well as each register's POR state. During shutdown, the serial interface remains fully functional.

Low-Cost, SMBus, CCFL Backlight Controller

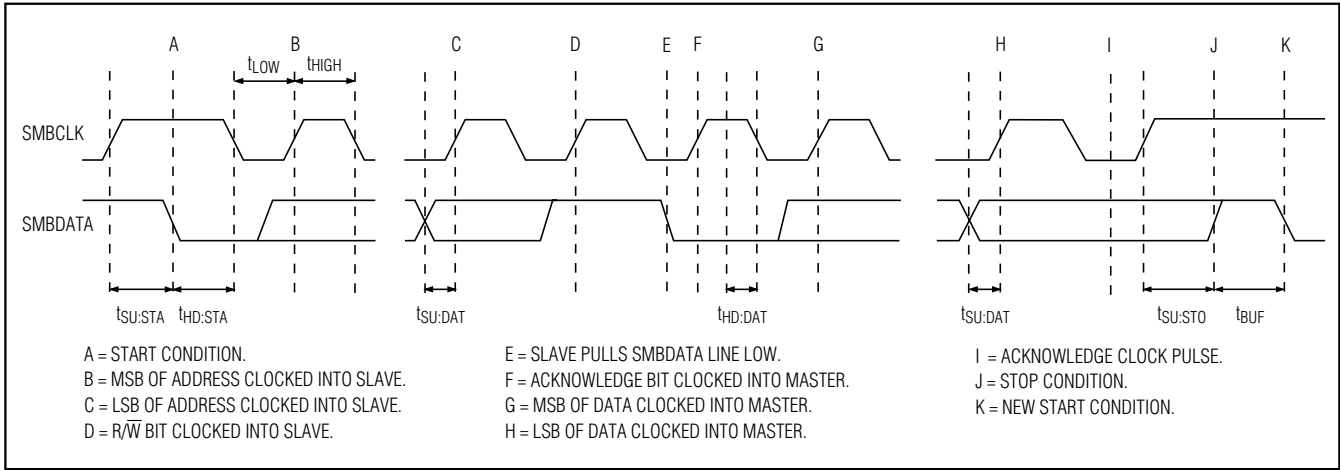

Figure 10. SMBus Read Timing

Table 3. Commands Description

SMBus PROTOCOL	COMMAND BYTE	POR STATE	DATA-REGISTER BIT ASSIGNMENT							
			BIT 7 (MSB)	BIT 6	BIT 5	BIT 4	BIT 3	BIT 2	BIT 1	BIT 0 (LSB)
Read and Write	0x00	0xFF	BR7	BRT6	BRT5	BR4	BRT3	BRT2	BRT1	BRT0
Read and Write	0x01	0x00	Reserved	Reserved	ALSDEL1	ALSDELO	ALS_CTL	PWM_MD	PWM_SEL	LAMP_CTL
Read Only	0x02	N/A	Reserved	Reserved	Reserved	Reserved	LAMP_STAT	OV_CURR	Reserved	FAULT
Read Only	0x03	0x01	MFG4	MFG3	MFG2	MFG1	MFG0	REV2	REV1	REV0
Read Only	0x04	0x00	ALS7	ALS6	ALS5	ALS4	ALS3	ALS2	ALS1	ALS0
Read and Write	0x05	0x00	ALSLL7	ALSLL6	ALSLL5	ALSLL4	ALSLL3	ALSLL2	ALSLL1	ALSLL0
Read and Write	0x06	0xFF	ALSHL7	ALSHL6	ALSHL5	ALSHL4	ALSHL3	ALSHL2	ALSHL1	ALSHL0

Low-Cost, SMBus, CCFL Backlight Controller

Brightness Control Register [0x00] (POR = 0xFF)

The brightness control register of the MAX8759 contains 8 bits and supports 256 brightness levels. A write-byte cycle to register 0x00 sets the brightness level if the inverter is in SMBus mode. A write-byte cycle to register 0x00 has no effect if the inverter is not in

SMBus mode. A read-byte cycle to register 0x00 returns the current brightness level regardless of the operation mode. A setting of 0xFF for register 0x00 sets the inverter to the maximum brightness. A setting of 0x00 for register 0x00 sets the inverter to the minimum brightness.

BIT 7 (R/W)	BIT 6 (R/W)	BIT 5 (R/W)	BIT 4 (R/W)	BIT 3 (R/W)	BIT 2 (R/W)	BIT 1 (R/W)	BIT 0 (R/W)
BRT7	BRT6	BRT5	BRT4	BRT3	BRT2	BRT1	BRT0

BRT[7..0]: 256 brightness levels.

Device Control Register [0x01] (POR = 0x00)

This register has a single bit that controls the inverter ON/OFF state, 3 bits that control the operating mode of

the inverter, and 2 bits for setting ALS delay time. The remaining bits are reserved for future use.

BIT 7	BIT 6	BIT 5 (R/W)	BIT 4 (R/W)	BIT 3 (R/W)	BIT 2 (R/W)	BIT 1 (R/W)	BIT 0 (R/W)
Reserved	Reserved	ALSDEL1	ALSDEL0	ALS_CTL	PWM_MD	PWM_SEL	LAMP_CTL

ALSDEL1: ALS delay select bit.

ALSDEL0: ALS delay select bit.

ALS_CTL: Ambient-light-sensor select bit (1 = use ALS, 0 = not use ALS).

PWM_MD: PWM mode select bit (1 = absolute brightness, 0 = percentage change).

PWM_SEL: Brightness control select bit (1 = control by PWM, 0 = control by SMBus).

LAMP_CTL: Inverter on/off bit (1 = on, 0 = off).

A value of 1 written to LAMP_CTL turns on the lamp as quickly as possible. A value of zero written to LAMP_CTL immediately turns off the lamp.

The PWM_SEL bit determines whether the SMBus or PWM input should control brightness when the inverter is not in ALS mode. This bit has no effect when ALS_CTL is set to 1.

The PWM_MD bit selects the manner in which the PWM input is to be interpreted. When this bit is zero, the PWM input reflects a percentage change in the current brightness (i.e., DPST mode) and follows the following equation:

$$\text{DPST brightness} = \text{BRT}_{\text{CURRENT}} \times \text{DPWM}$$

where $\text{BRT}_{\text{CURRENT}}$ is the current brightness setting from either ALS or SMBus without influence from the PWM input and DPWM is the duty cycle of the PWM signal.

When PWM_MD bit is 1, the PWM input has no effect on the brightness setting unless the inverter is in PWM mode.

When ALS_CTL is 1, the inverter controls brightness based primarily on the light reading from the ALS. However, the ALS brightness setting can be modified if the PWM_MD bit is set to zero. When the ALS_CTL bit is zero, the inverter controls the brightness according to the PWM input (PWM mode), the SMBus setting (SMBus mode), or a combination of the two (SMBus mode with DPST).

Low-Cost, SMBus, CCFL Backlight Controller

The relationships among these 3 control bits can be thought of as specifying an operating mode for the inverter. The defined modes are shown in Table 4. Note that depending on the settings of some bits, other bits have no effect and are don't-care bits—they are shown with a value of X in Table 4. For example, when the ALS_CTL bit is 1, the value of PWM_SEL has no effect on the operation of the inverter, so its value is shown as X.

ALSDEL0 and ALSDEL1 set the delay time required to change the brightness in ALS mode. This delay time is necessary for smooth transitions during brightness change. Table 5 shows the available delays.

Note that the behavior of register 0x00 (brightness control register) is affected by certain combinations of the control bits as shown in Table 4.

When SMBus mode is selected, register 0x00 reflects the last value written to it. However, when any non-SMBus mode is selected, register 0x00 reflects the current brightness value based on the current mode of operation.

Fault/Status Register [0x02] (POR = 0x00)

This register has 3 status bits that allow monitoring the inverter's operating state. Bit 0 is a logical OR of open-lamp fault and overcurrent fault. Bit 2 indicates secondary/UL overcurrent fault. Bit 3 always indicates the current lamp on/off status. The value of this bit is one whenever both lamp 1 and lamp 2 are on. The value of this bit is zero whenever lamp 1 or lamp 2 is off. The

BIT 7 (R)	BIT 6 (R)	BIT 5 (R)	BIT 4 (R)	BIT 3 (R)	BIT 2 (R)	BIT 1 (R)	BIT 0 (R)
Reserved	Reserved	Reserved	Reserved	LAMP_STAT	OV_CURR	Reserved	FAULT

LAMP_STAT: Lamp status bit (1 = lamp 1 and lamp 2 are on, 0 = lamp 1 or lamp 2 is off).

OV_CURR: Secondary/UL overcurrent fault (1 = secondary/UL overcurrent fault, 0 = no secondary/UL overcurrent).

FAULT: Fault bit (1 = open-lamp or primary overcurrent fault, 0 = no fault).

Table 4. Operating Modes Selected by Device Control Register Bits 3, 2, and 1

ALS_CTL	PWM_MD	PWM_SEL	MODE
1	1	X	ALS mode
1	0	X	ALS mode with DPST
0	X	1	PWM mode
0	1	0	SMBus mode
0	0	0	SMBus mode with DPST

Table 5. Delay Time Selected by Device Control Register Bits 5, 4

ALSDEL1	ALSDEL0	DELAY TIME (ms)	N PERIODS
1	1	25	5
1	0	15	3
0	1	10	2
0	0	20 (default)	4

remaining bits are reserved for future use. All reserved bits return a zero when read. All the bits in this register are read only. A write-byte cycle to register 0x02 has no effect. Write zero to bit 0 of register 0x01 to clear the fault bit.

Low-Cost, SMBus, CCFL Backlight Controller

Identification Register [0x03] (POR = 0x01)

The identification register contains two bit fields to denote the manufacturer and the silicon revision. The bit

field widths allow up to 32 vendors with up to eight silicon revisions each. This register is read only. A write-byte cycle to register 0x03 has no effect.

BIT 7 (R)	BIT 6 (R)	BIT 5 (R)	BIT 4 (R)	BIT 3 (R)	BIT 2 (R)	BIT 1 (R)	BIT 0 (R)
MFG4	MFG3	MFG2	MFG1	MFG0	REV2	REV1	REV0

MFG[4..0]: Manufacturer ID (the vendor ID for Maxim is 0).

REV[2..0]: Silicon rev (revs 0–7 allowed for silicon revisions).

ALS Status Register [0x04] (POR = 0x00)

The ALS should return a value reflecting the brightness setting based on the ALS input. The register has 8 bits that define a full range of 256 brightness levels. The

register is read only and a write-byte cycle has no effect. A read-byte cycle to register 0x04 returns the current reading of ALS, regardless of the operating mode set in register 0x01.

BIT 7 (R)	BIT 6 (R)	BIT 5 (R)	BIT 4 (R)	BIT 3 (R)	BIT 2 (R)	BIT 1 (R)	BIT 0 (R)
ALS7	ALS6	ALS5	ALS4	ALS3	ALS2	ALS1	ALS0

ALS[7..0]: 256 steps of ambient-light sensor reading.

ALS Low-Limit Register [0x05] (POR = 0x00)

The value in this read-write register reflects the lowest possible brightness value the inverter can set based on inputs from the ALS. Users can change this value so that they can control the effect of ALS. A write-byte cycle to register 0x05 sets the lowest possible brightness value

that can be set based on ALS inputs. If the brightness setting due to ALS is lower than the value written to this register, the inverter immediately increases the brightness setting to the newly written value. A read-byte cycle to register 0x05 returns the current minimum brightness value that can be set based on ALS inputs.

BIT 7 (R/W)	BIT 6 (R/W)	BIT 5 (R/W)	BIT 4 (R/W)	BIT 3 (R/W)	BIT 2 (R/W)	BIT 1 (R/W)	BIT 0 (R/W)
ALSLL7	ALSLL6	ALSLL5	ALSLL4	ALSLL3	ALSLL2	ALSLL1	ALSLL0

ALSLL[7..0]: The lowest brightness setting that can be set based on ALS inputs.