



Chipsmall Limited consists of a professional team with an average of over 10 year of expertise in the distribution of electronic components. Based in Hongkong, we have already established firm and mutual-benefit business relationships with customers from,Europe,America and south Asia,supplying obsolete and hard-to-find components to meet their specific needs.

With the principle of “Quality Parts,Customers Priority,Honest Operation,and Considerate Service”,our business mainly focus on the distribution of electronic components. Line cards we deal with include Microchip,ALPS,ROHM,Xilinx,Pulse,ON,Everlight and Freescale. Main products comprise IC,Modules,Potentiometer,IC Socket,Relay,Connector.Our parts cover such applications as commercial,industrial, and automotives areas.

We are looking forward to setting up business relationship with you and hope to provide you with the best service and solution. Let us make a better world for our industry!



Contact us

Tel: +86-755-8981 8866 Fax: +86-755-8427 6832

Email & Skype: info@chipsmall.com Web: www.chipsmall.com

Address: A1208, Overseas Decoration Building, #122 Zhenhua RD., Futian, Shenzhen, China





5V/3.3V or Adjustable, Low-Dropout, Low IQ, 200mA Linear Regulators

General Description

The MAX882/MAX883/MAX884 linear regulators maximize battery life by combining ultra-low supply currents and low dropout voltages. They feature 200mA output current capability at up to +125°C junction temperature and come in a 1.5W SOIC package. The 1.5W package (compared to 0.47W for standard SOIC packages) allows a wider operating range for the input voltage and output current. The MAX882/MAX883/MAX884 use a p-channel MOSFET pass transistor to maintain a low 11 μ A (15 μ A max) supply current from no-load to the full 200mA output. Unlike earlier bipolar regulators, there are no PNP base current losses that increase with output current. In dropout, the MOSFET does not suffer from excessive base currents that occur when PNP transistors go into saturation. Typical dropout voltages are 220mV at 5V and 200mA, or 320mV at 3.3V and 200mA.

The MAX882 features a 7 μ A standby mode that disables the output but keeps the reference, low-battery comparator, and biasing circuitry alive. The MAX883/MAX884 feature a shutdown (OFF) mode that turns off all circuitry, reducing supply current to less than 1 μ A. All three devices include a low-battery-detection comparator, fold-back current limiting, reverse-current protection, and thermal-overload protection.

The output is preset at 3.3V for the MAX882/MAX884 and 5V for the MAX883. In addition, all devices employ Dual Mode™ operation, allowing user-adjustable outputs from 1.25V to 11V using external resistors. The input voltage supply range is 2.7V to 11.5V.

For low-dropout linear regulators with output currents up to 500mA, refer to the MAX603/MAX604 data sheet.

Applications

Pagers and Cellular Phones
3.3V and 5V Regulators
1.25V to 11V Adjustable Regulators
High-Efficiency Linear Regulators
Battery-Powered Devices
Portable Instruments
Solar-Powered Instruments

Pin Configuration

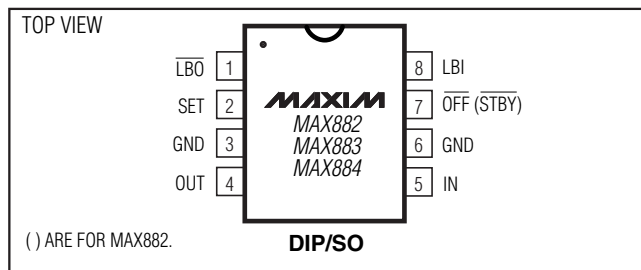

Dual Mode is a trademark of Maxim Integrated Products, Inc.



Features

- ◆ Foldback Current Limiting
- ◆ High-Power (1.5W) 8-Pin SO Package
- ◆ Dual Mode Operation: Fixed or Adjustable Output from 1.25V to 11V
- ◆ Large Input Range (2.7V to 11.5V)
- ◆ Internal 1.1 Ω p-Channel Pass Transistor Draws No Base Current
- ◆ Low 220mV Dropout Voltage at 200mA Output Current
- ◆ 11 μ A (typ) Quiescent Current
- ◆ 1 μ A (max) Shutdown Mode or 7 μ A (typ) Standby Mode
- ◆ Low-Battery Detection Comparator
- ◆ Reverse-Current Protection
- ◆ Thermal-Overload Protection

Ordering Information

PART	TEMP RANGE	PIN-PACKAGE
MAX882CPA	0°C to +70°C	8 PDIP
MAX882CSA	0°C to +70°C	8 SO
MAX882C/D	0°C to +70°C	Dice*
MAX882EPA	-40°C to +85°C	8 PDIP
MAX882ESA	-40°C to +85°C	8 SO

Ordering Information continued at end of data sheet.

*Dice are tested at $T_J = +25^\circ\text{C}$, DC parameters only.

**Contact factory for availability.

Typical Operating Circuit

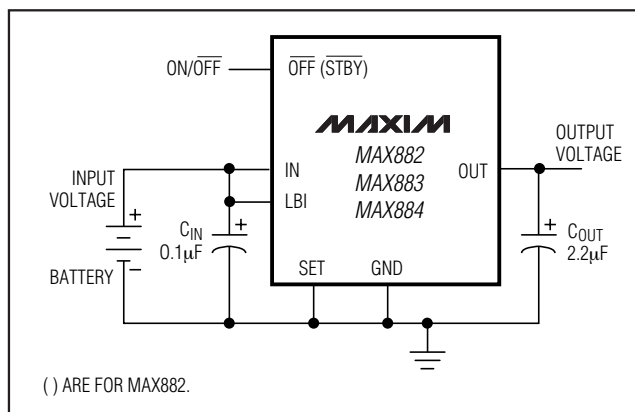

MAX882/MAX883/MAX884

5V/3.3V or Adjustable, Low-Dropout, Low IQ, 200mA Linear Regulators

ABSOLUTE MAXIMUM RATINGS

Supply Voltage (IN or OUT to GND).....-0.3V to +12V
 Output Short-Circuit Duration1min
 Continuous Output Current.....300mA
 LBO Output Current.....50mA
 LBO Output Voltage and LBI,
 SET, STBY, OFF Input Voltages-0.3V to the greater of
 (IN + 0.3V) or (OUT + 0.3V)
 Continuous Power Dissipation (T_J = +70°C)
 Plastic DIP (derate 9.09mW/°C above +70°C)727mW

High-Power SO (derate 18.75mW/°C above +70°C)1.5W
 CERDIP (derate 8.00mW/°C above +70°C)640mW
 Operating Temperature Ranges
 MAX88_C_A0°C to +70°C
 MAX88_E_A-40°C to +85°C
 Junction Temperature+150°C
 Storage Temperature Range-65°C to +160°C
 Lead Temperature (soldering, 10s)+300°C

Stresses beyond those listed under "Absolute Maximum Ratings" may cause permanent damage to the device. These are stress ratings only, and functional operation of the device at these or any other conditions beyond those indicated in the operational sections of the specifications is not implied. Exposure to absolute maximum rating conditions for extended periods may affect device reliability.

ELECTRICAL CHARACTERISTICS

(V_{IN} = 6V (MAX883) or V_{IN} = 4.3V (MAX882/MAX884), C_{OUT} = 2.2μF, STBY or OFF = V_{IN}, SET = GND, LBI = V_{IN}, T_J = -40°C to +85°C, unless otherwise noted. Typical values are at T_J = +25°C.) (Note 1)

PARAMETER	SYMBOL	CONDITIONS	MIN	TYP	MAX	UNITS	
Input Voltage Range	V _{IN}	SET = OUT, R _L = 1kΩ	MAX88_C_A	2.7	11.5	V	
			MAX88_E_A	2.9	11.5		
			MAX88_MJA	3.0	11.5		
Output Voltage (Note 2)	V _{OUT}	MAX883, 6.0V ≤ V _{IN} ≤ 11.5V	I _{OUT} = 100μA - 250mA, 0°C ≤ T _J ≤ +85°C	4.75	5.00	5.25	V
			I _{OUT} = 100μA - 250mA, -40°C ≤ T _J ≤ +85°C	4.65		5.35	
		MAX882/MAX884, 4.3V ≤ V _{IN} ≤ 11.5V	I _{OUT} = 100μA - 200mA, 0°C ≤ T _J ≤ +85°C	3.15	3.30	3.45	
			I _{OUT} = 100μA - 200mA, -40°C ≤ T _J ≤ +85°C	3.07		3.53	
Load Regulation	ΔV _{LDR}	I _{OUT} = 1mA to 200mA	MAX883C_A/E_A	60	100	mV	
			MAX883MJA		150		
		I _{OUT} = 1mA to 150mA	MAX882, MAX884	30	100		
Line Regulation	ΔV _{LNR}	(V _{OUT} + 0.5V) < V _{IN} < 11.5V, I _{OUT} = 10mA		10	40	mV	
Dropout Voltage (Note 3)	ΔV _{DO}	MAX883	I _{OUT} = 100mA	110	220	mV	
			I _{OUT} = 200mA	220	440		
		MAX882/MAX884	I _{OUT} = 100mA	160	320		
			I _{OUT} = 200mA	320	640		
Quiescent Current	I _Q	SET = OUT, V _{IN} = 6V	MAX88_C_A/E_A	11	15	μA	
			MAX88_MJA		30		
		V _{IN} = 11.5V	MAX88_C_A/E_A	15	25		
			MAX88_MJA		40		

5V/3.3V or Adjustable, Low-Dropout, Low IQ, 200mA Linear Regulators

MAX882/MAX883/MAX884

ELECTRICAL CHARACTERISTICS (continued)

($V_{IN} = 6V$ (MAX883) or $V_{IN} = 4.3V$ (MAX882/MAX884), $C_{OUT} = 2.2\mu F$, STBY or OFF = V_{IN} , SET = GND, LBI = V_{IN} , $T_J = -40^\circ C$ to $+85^\circ C$, unless otherwise noted. Typical values are at $T_J = +25^\circ C$.) (Note 1)

PARAMETER	SYMBOL	CONDITIONS		MIN	TYP	MAX	UNITS	
STBY Quiescent Current (Note 4)	$I_{Q\ STBY}$	STBY = 0, $V_{IN} = 6V$, SET = OUT	MAX882C_A/E_A	7	15	30	μA	
			MAX882MJA					
		STBY = 0, $V_{IN} = 11.5V$, SET = OUT	MAX882C_A/E_A	10	25	40		
			MAX882MJA					
OFF Quiescent Current	$I_{Q\ OFF}$	OFF = 0, $R_L = 1k\Omega$, $V_{IN} = 11.5V$ MAX883/MAX884	MAX88_C_A	0.01	1	5	μA	
			MAX88_E_A					
			MAX88_MJA					10
Minimum Load Current	$I_{OUT(MIN)}$	$V_{IN} = 11.5V$, SET = OUT	MAX88_C_A		1	3	μA	
			MAX88_E_A					
			MAX88_MJA					10
Foldback Current Limit (Note 5)	ILIM	$V_{OUT} < 0.8V$		170		430	mA	
		$V_{OUT} > 0.8V$ and $V_{IN} - V_{OUT} > 0.7V$						
Thermal Shutdown Temperature	T_{SD}			+160			$^\circ C$	
Thermal Shutdown Hysteresis	ΔT_{SD}			10			$^\circ C$	
Reverse-Current-Protection (Note 6)	ΔV_{RTH}	$V_{OUT} = 4.5V$	MAX883_A	6	20	20	mV	
		$V_{OUT} = 3.0V$	MAX882_A, MAX884_A	6				
Reverse Leakage Current	I_{RVL}	MAX882: $V_{IN} = 0$, STBY = 0, $V_{OUT} = 3.0V$		7		0.01	μA	
		MAX883/MAX884: $V_{IN} = 0$, OFF = 0, $V_{OUT} = 3.0V$						
Startup Overshoot	V_{OSH}	$R_L = 1k\Omega$, $C_{OUT} = 2.2\mu F$					% of V_{OUT}	
Time Required to Exit OFF or STBY Modes	T_{START}	$V_{IN} = 9V$, $R_L = 33\Omega$, OFF from 0 to V_{IN} , 0% to 95% of V_{OUT}		200			μs	
Dual Mode SET Threshold	$V_{SET\ TH}$	For internal feedback		65	30	150	mV	
		For external feedback		65				
SET Reference Voltage	V_{SET}	SET = OUT, $R_L = 1k\Omega$	$0^\circ C \leq T_J \leq +85^\circ C$	1.16	1.20	1.24	V	
			$-40^\circ C \leq T_J \leq +85^\circ C$	1.12		1.28		
SET Input Leakage Current	I_{SET}	$V_{SET} = 1.5V$ or 0		± 0.01	± 50		nA	
LBI Threshold Voltage	V_{LBI}	LBI signal falling	$0^\circ C \leq T_J \leq +85^\circ C$	1.15	1.20	1.25	V	
			$-40^\circ C \leq T_J \leq +85^\circ C$	1.11		1.29		
LBI Hysteresis	ΔV_{LBI}			7			mV	
LBI Input Leakage Current	I_{LBI}	$V_{LBI} = 1.5V$		± 0.01	± 50		nA	
\overline{LBO} Output Low Voltage	$V_{\overline{LBO}L}$	\overline{LBO} sink = 1.2mA, $V_{LBI} = 1V$, $3V < V_{IN} < 11.5V$, SET = OUT		90	250		mV	
\overline{LBO} Output Leakage Current	$I_{\overline{LBO}LKG}$	$V_{LBI} = V_{IN}$, $V_{LBO} = V_{IN}$		0.01	0.1		μA	
OUT Leakage Current	$I_{OUT\ LKG}$	$V_{IN} = 11.5V$, $V_{OUT} = 2V$, SET = OUT	MAX88_C_A	0.01	1	3	μA	
			MAX88_E_A					
			MAX88_MJA					10

5V/3.3V or Adjustable, Low-Dropout, Low IQ, 200mA Linear Regulators

ELECTRICAL CHARACTERISTICS (continued)

($V_{IN} = 6V$ (MAX883) or $V_{IN} = 4.3V$ (MAX882/MAX884), $C_{OUT} = 2.2\mu F$, STBY or OFF = V_{IN} , SET = GND, LBI = V_{IN} , $T_J = -40^\circ C$ to $+85^\circ C$, unless otherwise noted. Typical values are at $T_J = +25^\circ C$.) (Note 1)

PARAMETER	SYMBOL	CONDITIONS	MIN	TYP	MAX	UNITS
STBY Threshold Voltage	V_{STBY}	STBY signal falling, MAX882_A	1.15	1.20	1.25	V
STBY Hysteresis	ΔV_{STBY}	MAX882_A		7		mV
STBY Input Leakage Current	I_{STBY}	$V_{STBY} = V_{IN}$ or 0, MAX882_A		± 0.01	± 50	nA
OFF Threshold Voltage	$V_{IL\ OFF}$	In off mode, MAX883_A, MAX884_A			0.4	V
	$V_{IH\ OFF}$	In on mode, SET = OUT, $V_{IN} < 6V$, MAX883_A, MAX884_A	2.0			
		In on mode, SET = OUT, $6V < V_{IN} < 11.5V$, MAX883_A, MAX884_A	3.0			
OFF Input Leakage Current	I_{OFF}	$V_{OFF} = V_{IN}$ or 0		± 0.01	± 50	nA
Output Noise	e_n	10Hz to 10kHz, SET = OUT, $R_L = 1k\Omega$, $C_{OUT} = 2.2\mu F$ (Note 7)		250		μV_{RMS}

Note 1: Electrical specifications are measured by pulse testing and are guaranteed for a junction temperature (T_J) within the operating temperature range, unless otherwise noted. Specifications to $-40^\circ C$ are guaranteed by design and not production tested.

Note 2: ($V_{IN} - V_{OUT}$) is limited to keep the product ($I_{OUT} \times (V_{IN} - V_{OUT})$) from exceeding the package power dissipation limits. See Figure 5. Therefore, the combination of high output current and high supply voltage is not tested.

Note 3: Dropout Voltage is ($V_{IN} - V_{OUT}$) when V_{OUT} falls to 100mV below its nominal value at $V_{IN} = (V_{OUT} + 2V)$. For example, the MAX883 is tested by measuring the V_{OUT} at $V_{IN} = 7V$, then V_{IN} is lowered until V_{OUT} falls 100mV below the measured value. The difference ($V_{IN} - V_{OUT}$) is then measured and defined as ΔV_{DO} .

Note 4: Since standby mode inhibits the output but keeps all biasing circuitry alive, the Standby Quiescent Current is similar to the normal operating quiescent current.

Note 5: Foldback Current Limit was characterized by pulse testing to remain below the maximum junction temperature (not production tested).

Note 6: The Reverse-Current Protection Threshold is the output/input differential voltage ($V_{OUT} - V_{IN}$) at which reverse-current protection switchover occurs and the pass transistor is turned off. See the section *Reverse-Current Protection* in the *Detailed Description*.

Note 7: Noise is tested using a bandpass amplifier with two poles at 10Hz and two poles at 10kHz.

5V/3.3V or Adjustable, Low-Dropout, Low IQ, 200mA Linear Regulators

MAX882/MAX883/MAX884

Typical Operating Characteristics

($V_{IN} = 7V$ for MAX883, $V_{IN} = 5.3V$ for MAX882/MAX884, OFF or STBY = VIN, SET = GND, LBI = V_{IN} , \overline{LBO} = OPEN, $C_{IN} = C_{OUT} = 2.2\mu F$, $R_L = 1k\Omega$, $T_A = +25^\circ C$, unless otherwise noted.)

OUTPUT VOLTAGE AND QUIESCENT CURRENT vs. LOAD CURRENT

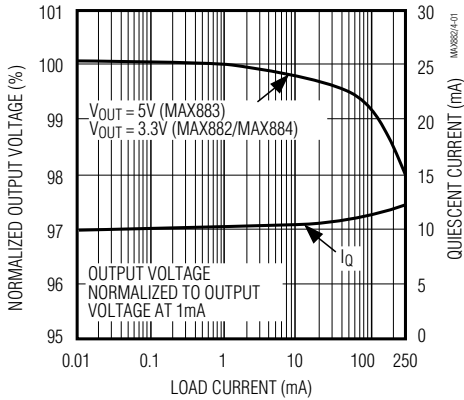

OUTPUT VOLTAGE vs. TEMPERATURE

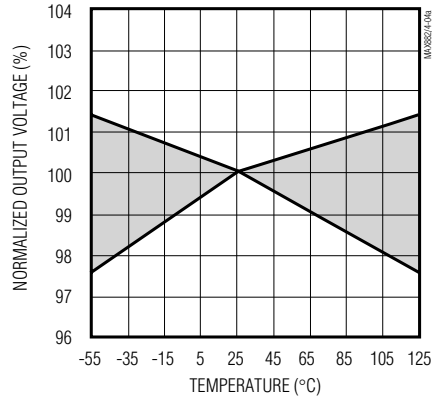

OUTPUT VOLTAGE AND QUIESCENT CURRENT vs. SUPPLY VOLTAGE

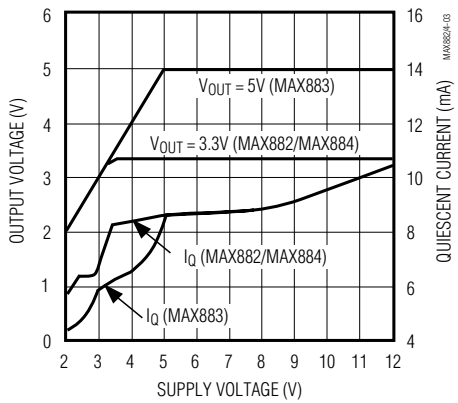

QUIESCENT CURRENT vs. TEMPERATURE

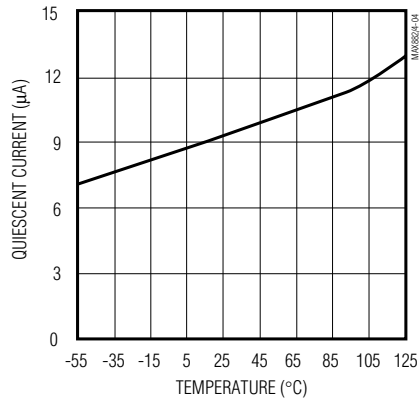

DROPOUT VOLTAGE vs. LOAD CURRENT

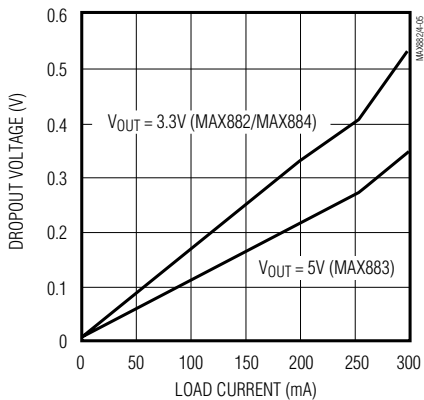

10Hz to 10kHz OUTPUT NOISE

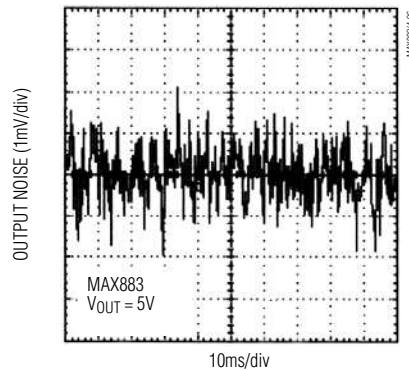

5V/3.3V or Adjustable, Low-Dropout, Low IQ, 200mA Linear Regulators

Typical Operating Characteristics (continued)

($V_{IN} = 7V$ for MAX883, $V_{IN} = 5.3V$ for MAX882/MAX884, OFF or STBY = V_{IN} , SET = GND, LBI = V_{IN} , $\overline{LBO} = OPEN$, $C_{IN} = C_{OUT} = 2.2\mu F$, $R_L = 1k\Omega$, $T_A = +25^\circ C$, unless otherwise noted.)

LINE-TRANSIENT RESPONSE

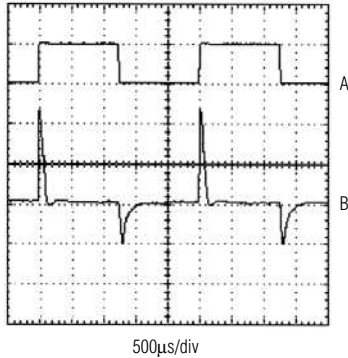

MAX883: $V_{OUT} = 5V$, $C_{IN} = 0\mu F$, $t_R = 15\mu s$, $t_F = 13\mu s$
 A: $V_{IN} = 8V$ (HIGH) / $V_{IN} = 7V$ (LOW)
 B: OUTPUT VOLTAGE (100mV/div)

LOAD-TRANSIENT RESPONSE

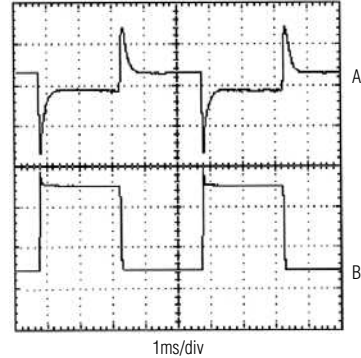

MAX883: $V_{OUT} = 5V$, $t_R = 24\mu s$, $t_F = 44\mu s$
 A: OUTPUT VOLTAGE (100mV/div)
 B: $I_{OUT} = 250mA$ (HIGH) / $I_{OUT} = 50mA$ (LOW)

OVERSHOOT AND TIME EXITING SHUTDOWN MODE

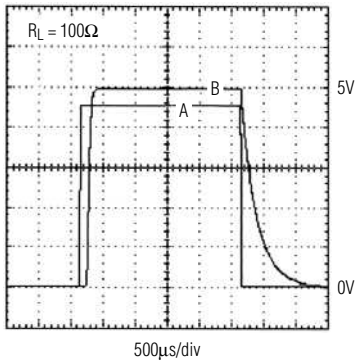

$R_L = 100\Omega$
 A: \overline{OFF} PIN VOLTAGE (1V/div):
 RISE TIME = $9\mu s$
 B: MAX883 OUTPUT VOLTAGE (1V/div):
 DELAY = $135\mu s$, RISE TIME = $67\mu s$,
 OVERSHOOT = 0%

\overline{LBO} LOW VOLTAGE vs. SINK CURRENT

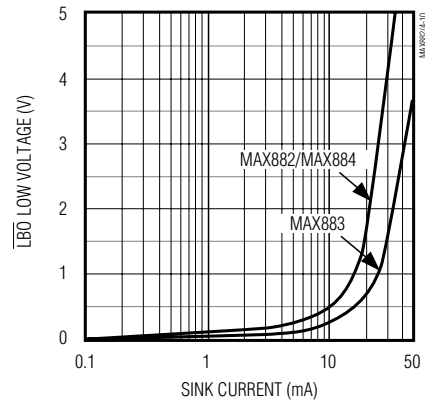

5V/3.3V or Adjustable, Low-Dropout, Low IQ, 200mA Linear Regulators

Pin Description

PIN		NAME	DESCRIPTION
MAX882	MAX883/ MAX884		
1	1	$\overline{\text{LBO}}$	Low-Battery Output is an open-drain output that goes low when LBI is less than 1.2V. Connect to IN or OUT through a pull-up resistor. $\overline{\text{LBO}}$ is undefined during shutdown mode (MAX883/MAX884).
2	2	SET	Feedback for setting the output voltage. Connect to GND to set the output voltage to the preselected 3.3V or 5V. Connect to an external resistor network for adjustable-output operation.
3, 6	3, 6	GND	Ground pins—also function as heatsinks in the SO package. All GND pins must be soldered to the PC board for proper power dissipation. Connect to large copper pads or planes to channel heat from the IC.
4	4	OUT	Regulator Output. Fixed or adjustable from 1.25V to 11.0V. Sources up to 200mA. Bypass with a 2.2 μ F capacitor.
5	5	IN	Regulator Input. Supply voltage can range from 2.7V to 11.5V.
7	—	STBY	Standby. Active-low comparator input. Connect to GND to disable the output or to IN for normal operation. A resistor network (from IN) can be used to set a standby mode threshold.
—	7	OFF	Shutdown. Active-low logic input. In OFF mode, supply current is reduced below 1 μ A and $V_{\text{OUT}} = 0$.
8	8	LBI	Low-Battery comparator Input. Tie to IN when not used.

Detailed Description

The MAX882/MAX883/MAX884 are micropower, low-dropout linear regulators designed primarily for battery-powered applications. They feature Dual Mode operation, allowing a fixed output of 5V for the MAX883 and 3.3V for the MAX882/MAX884, or an adjustable output from 1.25V to 11V. These devices supply up to 200mA while requiring less than 15 μ A quiescent current. As illustrated in Figure 1, they consist of a 1.20V reference, error amplifier, MOSFET driver, p-channel pass transistor, dual-mode comparator, and feedback voltage-divider.

The 1.20V reference is connected to the error amplifier's inverting input. The error amplifier compares this reference with the selected feedback voltage and amplifies the difference. The MOSFET driver reads the error signal and applies the appropriate drive to the p-channel pass transistor. If the feedback voltage is lower than the reference, the pass transistor's gate is pulled lower, allowing more current to pass and increasing the output voltage. If the feedback voltage is too high, the pass transistor gate is pulled up, allowing less current to pass to the output.

The output voltage is fed back through either an internal resistor voltage-divider connected to the OUT pin, or an external resistor network connected to the SET pin. The dual-mode comparator examines the SET pin voltage and selects the feedback path used. If the SET pin is below 65mV, internal feedback is used and the output voltage is regulated to 5V for the MAX883 or

3.3V for the MAX882/MAX884. Additional blocks include a foldback current limiter, reverse-current protection, a thermal sensor, shutdown or standby logic, and a low-battery-detection comparator.

Internal p-Channel Pass Transistor

The MAX882/MAX883/MAX884 feature a 200mA P-channel MOSFET pass transistor. This provides several advantages over similar designs using PNP pass transistors, including longer battery life.

The p-channel MOSFET requires no base drive, which reduces quiescent current considerably. PNP-based regulators waste large amounts of current in dropout when the pass transistor saturates. They also use high base-drive currents under large loads. The MAX882/MAX883/MAX884 do not suffer from these problems and consume only 11 μ A of quiescent current during light loads, heavy loads, and dropout.

Output Voltage Selection

The MAX882/MAX883/MAX884 feature Dual Mode operation. In preset voltage mode, the MAX883's output is set to 5V and the MAX882/MAX884's output is set to 3.3V, using internal trimmed feedback resistors. Select this mode by connecting SET to ground.

In preset voltage mode, impedances between SET and ground should be less than 100k Ω . Otherwise, spurious conditions could cause the voltage at SET to exceed the 65mV dual-mode threshold.

5V/3.3V or Adjustable, Low-Dropout, Low IQ, 200mA Linear Regulators

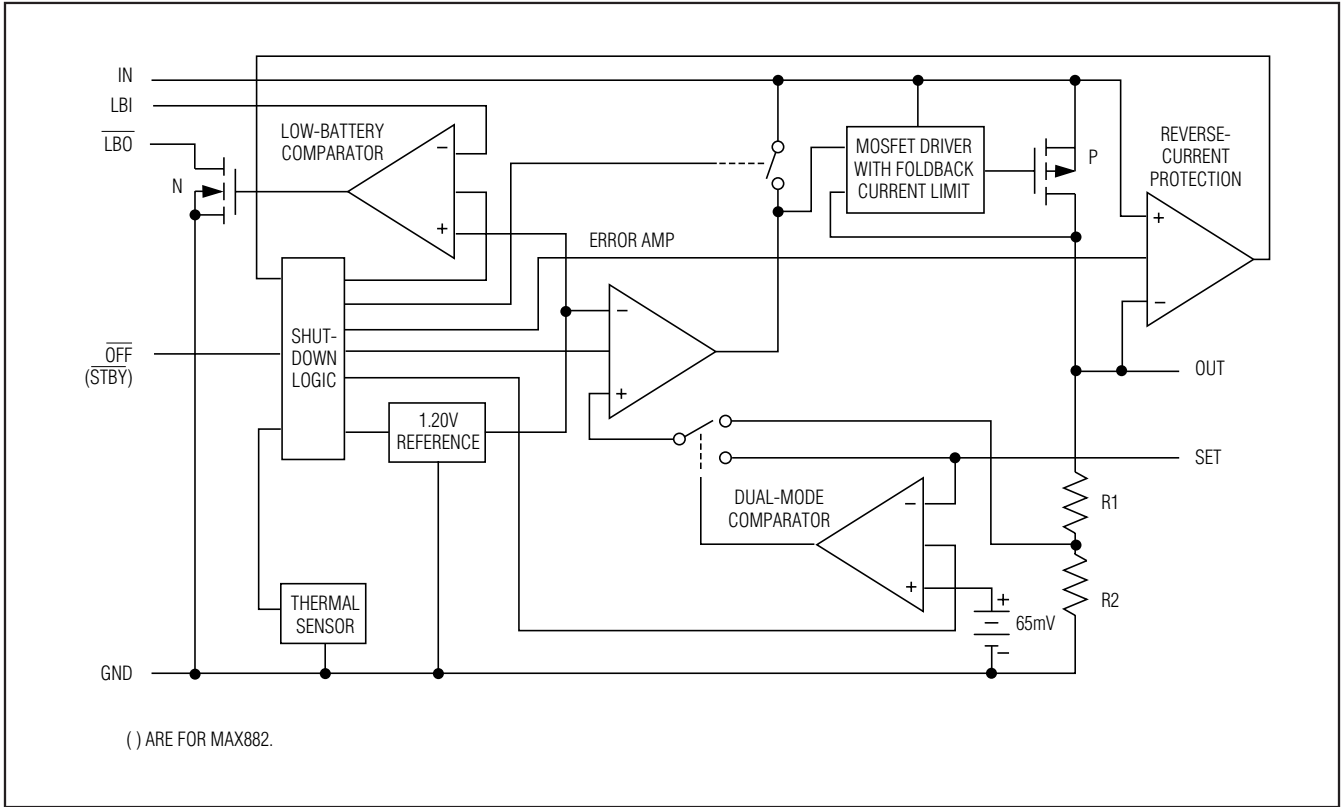

Figure 1. MAX882/MAX883/MAX884 Functional Diagram

In adjustable mode, the user selects an output voltage in the 1.25V to 11V range by connecting two external resistors, used as a voltage-divider, to the SET pin (Figure 2).

The output voltage is set by the following equation:

$$V_{OUT} = V_{SET} \left(1 + \frac{R1}{R2} \right)$$

where $V_{SET} = 1.20V$.

To simplify resistor selection:

$$R1 = R2 \left(\frac{V_{OUT}}{V_{SET}} - 1 \right)$$

Since the input bias current at SET is nominally zero, large resistance values can be used for R1 and R2 to minimize power consumption without losing accuracy. Up to 1.5MΩ is acceptable for R2. Since the V_{SET} tolerance is less than ±40mV, the output can be set using fixed resistors instead of trim pots.

Standby Mode (MAX882)

The MAX882 has a standby feature that disconnects the input from the output when STBY is brought low, but keeps all other circuitry awake. In this mode, V_{OUT} drops to 0, and the internal biasing circuitry (including the low-battery comparator) remains on. The maximum quiescent current during standby is 15μA. STBY is a comparator input with the other input internally tied to the reference voltage. Use a resistor network as shown in Figure 3 to set a standby-mode threshold voltage for undervoltage lockout. Connect STBY to IN for normal operation.

OFF Mode (MAX883/MAX884)

A low-logic input on the OFF pin shuts down the MAX883/MAX884. In this mode, the pass transistor, control circuit, reference, and all biases are turned off, and the supply current is reduced to less than 1μA. LBO is undefined in OFF mode. Connect OFF to IN for normal operation.

5V/3.3V or Adjustable, Low-Dropout, Low IQ, 200mA Linear Regulators

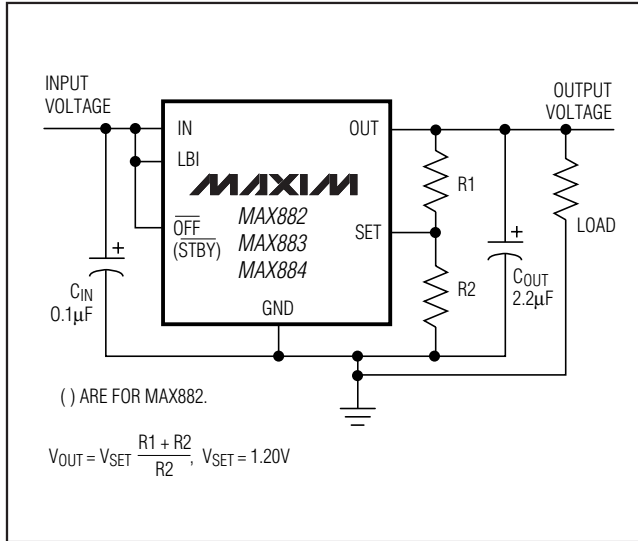

Figure 2. Adjustable Output Using External Feedback Resistors

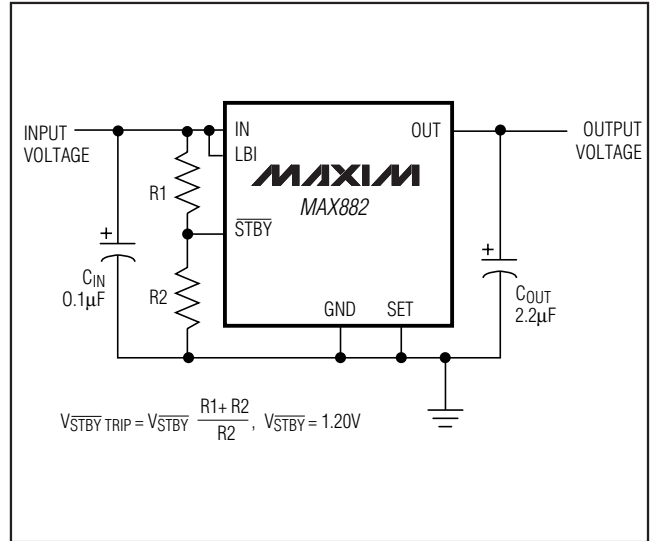

Figure 3. Setting an Undervoltage Lockout Threshold Using STBY

Foldback Current Limiting

The MAX882/MAX883/MAX884 also include a foldback current limiter. It monitors and controls the pass transistor's gate voltage, estimating the output current and limiting it to 430mA for output voltages above 0.8V and $(V_{IN} - V_{OUT}) > 0.7V$. If the output voltage drops below 0.8V, implying a short-circuit condition, the output current is limited to 170mA. The output can be shorted to ground for 1min without damaging the device if the package can dissipate $(V_{IN} \times 170mA)$ without exceeding $T_J = +150^\circ C$. When the output is greater than 0.8V and $(V_{IN} - V_{OUT}) < 0.7V$ (dropout operation), no current limiting is allowed, to provide maximum load drive.

Thermal Overload Protection

Thermal overload protection limits total power dissipation in the MAX882/MAX883/MAX884. When the junction temperature exceeds $T_J = +160^\circ C$, the thermal sensor sends a signal to the shutdown logic, turning off the pass transistor and allowing the IC to cool. The thermal sensor turns the pass transistor on again after the IC's junction temperature cools by $10^\circ C$, resulting in a pulsed output during thermal overload conditions.

Thermal overload protection is designed to protect the MAX882/MAX883/MAX884 if fault conditions occur. It is not intended to be used as an operating mode. Prolonged operation in thermal-shutdown mode may reduce the IC's reliability. For continual operation, do not exceed the absolute maximum junction temperature rating of $T_J = +150^\circ C$.

Power Dissipation and Operating Region

Maximum power dissipation of the MAX882/MAX883/MAX884 depends on the thermal resistance of the case and PC board, the temperature difference between the die junction and ambient air, and the rate of air flow. The power dissipation across the device is $P = I_{OUT} (V_{IN} - V_{OUT})$. The resulting power dissipation is as follows:

$$P = \frac{(T_J - T_A)}{(\theta_{JB} + \theta_{BA})}$$

where $(T_J - T_A)$ is the temperature difference between the MAX882/MAX883/MAX884 die junction and the surrounding air, θ_{JB} (or θ_{JC}) is the thermal resistance of the package chosen, and θ_{BA} is the thermal resistance through the PC board, copper traces, and other materials to the surrounding air.

The 8-pin small-outline package for the MAX882/MAX883/MAX884 features a special lead frame with a lower thermal resistance and higher allowable power dissipation. This package's thermal resistance package is $\theta_{JB} = 53^\circ C/W$, compared with $\theta_{JB} = 110^\circ C/W$ for an 8-pin plastic DIP package and $\theta_{JB} = 125^\circ C/W$ for an 8-pin ceramic DIP package.

5V/3.3V or Adjustable, Low-Dropout, Low IQ, 200mA Linear Regulators

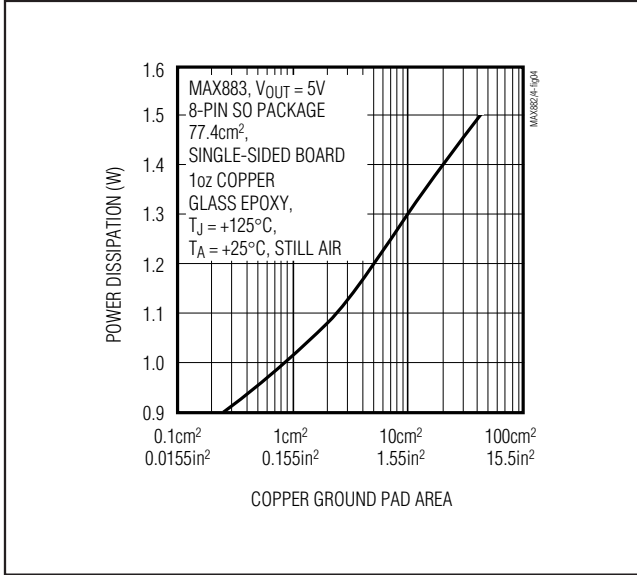

Figure 4. Typical Maximum Power Dissipation vs. Ground Pad Area

The GND pins of the MAX882/MAX883/MAX884 SOIC package perform the dual function of providing an electrical connection to ground and channeling heat away. Connect all GND pins to ground using a large pad or ground plane. Where this is impossible, place a copper plane on an adjacent layer. For a given power dissipation, the pad should exceed the associated dimensions in Figure 4.

Figure 4 assumes the IC is in an 8-pin small-outline package that has a maximum junction temperature of +125°C and is soldered directly to the pad; it also has a +25°C ambient air temperature and no other heat sources. Use larger pad sizes for other packages, lower junction temperatures, higher ambient temperatures, or conditions where the IC is not soldered directly to the heat-sinking ground pad. When operating C- and E-grade parts up to a T_J of +125°C, expect performance similar to M-grade specifications. For T_J between +125°C and +150°C, the output voltage may drift more.

The MAX882/MAX883/MAX884 can regulate currents up to 250mA and operate with input voltages up to 11.5V, but not simultaneously. High output currents can only be sustained when input-output differential voltages are small, as shown in Figure 5. Maximum power dissipation depends on packaging, temperature, and air flow. The maximum output current is as follows:

$$I_{OUT(MAX)} = \frac{P(T_J - T_A)}{(V_{IN} - V_{OUT})100^\circ C}$$

where P is derived from Figure 4.

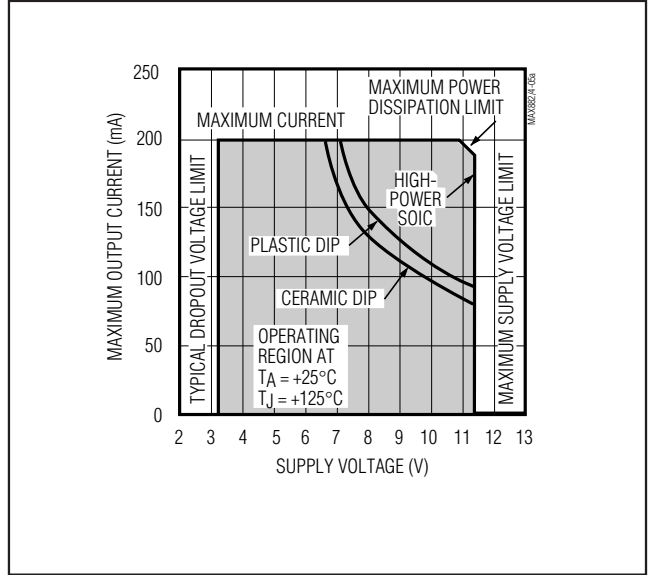

Figure 5a. Safe Operating Regions: MAX882/MAX884 Maximum Output Current vs. Supply Voltage

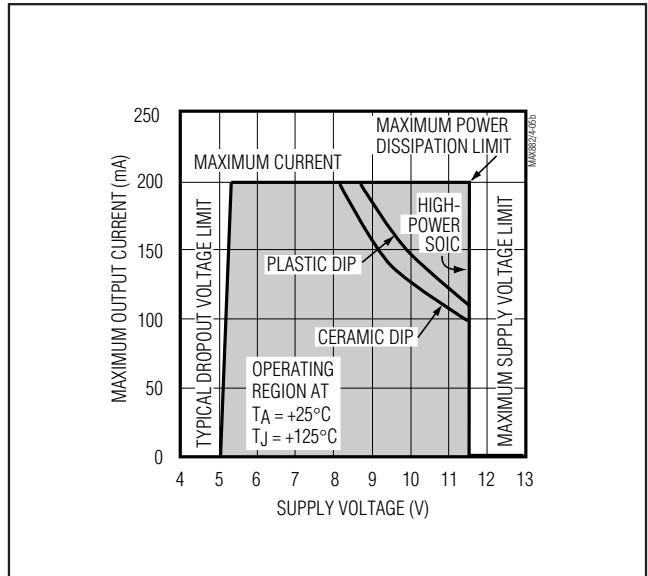

Figure 5b. Safe Operating Regions: MAX883 Maximum Output Current vs. Supply Voltage

5V/3.3V or Adjustable, Low-Dropout, Low IQ, 200mA Linear Regulators

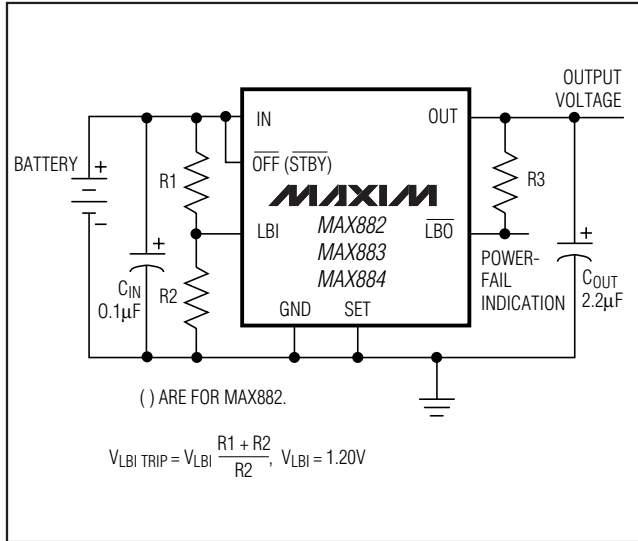

Figure 6. Using the Low-Battery Comparator to Monitor Battery Voltage

Reverse-Current Protection

The MAX882/MAX883/MAX884 have a unique protection scheme that limits reverse currents when the input voltage falls below the output. It monitors the voltages on IN and OUT and switches the IC's substrate and power bus to the more positive of the two. The control circuitry is then able to remain functioning and turn the pass transistor off, limiting reverse currents back through to the input of the device. In this mode, typical current into OUT to GND is 15µA at $V_{OUT} = 3.3V$ and 50µA at $V_{OUT} = 5V$.

Reverse-current protection activates when the voltage on IN falls 6mV (or 20mV max) below the voltage on OUT. Before this happens, currents as high as several milliamperes can flow back through the device.

Low-Battery-Detection Comparator

The MAX882/MAX883/MAX884 provide a low-battery comparator that compares the voltage on the LBI pin to the 1.20V internal reference. \overline{LBO} , an open-drain output, goes low when LBI is below 1.20V. Hysteresis of 7mV has been added to the low-battery comparator to provide noise immunity during switching. \overline{LBO} remains functional in standby mode for the MAX882, but is undefined in OFF mode for the MAX883 and MAX884. Tie LBI to IN when not used.

Use a resistor-divider network as shown in Figure 6 to set the low-battery trip voltage. Current into the LBI input is $\pm 50nA$ (max), so R2 can be as large as 1MΩ. Add extra noise immunity by connecting a small capacitor from LBI to GND. Additional hysteresis can be added by connecting a high-value resistor from LBI to \overline{LBO} .

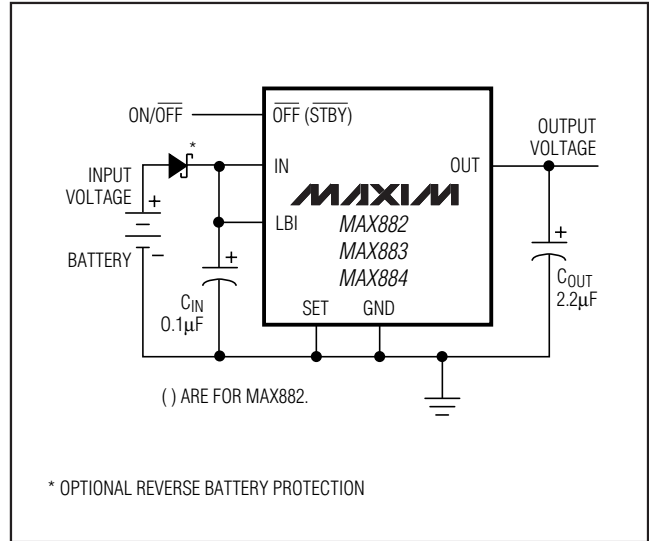

Figure 7. Typical 3.3V or 5V Linear Regulator Circuit

Applications Information

The MAX882/MAX883/MAX884 are series linear regulators designed primarily for battery-powered systems. Figure 7 shows a typical application.

Standby Mode vs. OFF Mode

STBY is a comparator input that allows the user to set the standby-mode threshold voltage, while OFF is a logic-level input. When in standby mode, the output is disconnected from the input, but the biasing circuitry (including the low-battery comparator) is kept alive, causing the device to draw approximately 7µA. Standby mode is useful in applications where a low-battery comparator function is still needed in shutdown.

A logic low at the OFF pin turns off all biasing circuitry, including the LBI/ \overline{LBO} comparator, and reduces supply current to less than 1µA. OFF mode is useful for maximizing battery life. There is little difference in the time it takes to exit standby mode or OFF mode.

Output Capacitor Selection and Regulator Stability

An output filter capacitor is required at the MAX882/MAX883/MAX884 OUT pin. The minimum output capacitance required for stability is 2.2µF.

5V/3.3V or Adjustable, Low-Dropout, Low IQ, 200mA Linear Regulators

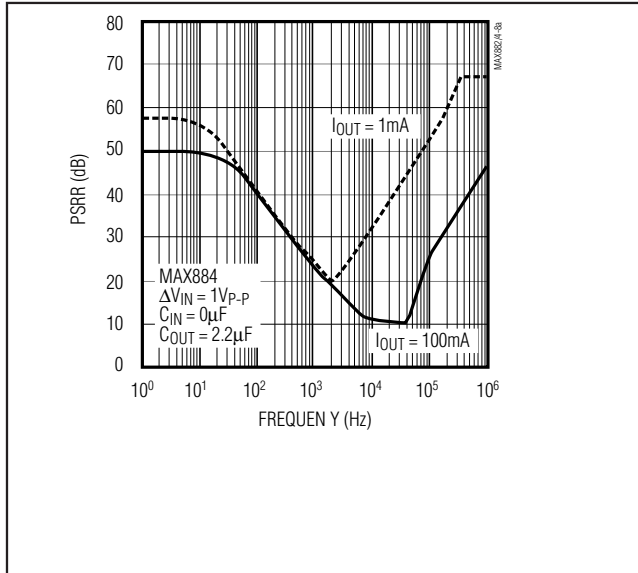

Figure 8a. Power-Supply Rejection Ratio vs. Ripple Frequency for Light and Heavy Loads

The filter capacitor's size depends primarily on the desired power-up time and load-transient responses. Load-transient response is improved by using larger output capacitors.

The output capacitor's equivalent series resistance (ESR) will not affect stability as long as the minimum capacitance requirement is observed. The type of capacitor selected is not critical, but it must remain above the minimum value over the full operating temperature range.

Input Bypass Capacitor

Normally, use 0.1 μ F to 10 μ F capacitors on the MAX882/MAX883/MAX884 input. The best value depends primarily on the power-up slew rate of V_{IN} , and on load and line transients. Larger input capacitor values provide better supply-noise rejection and line-transient response, as well as improved performance, when the supply has a high AC impedance. The type of input bypass capacitor used is not critical.

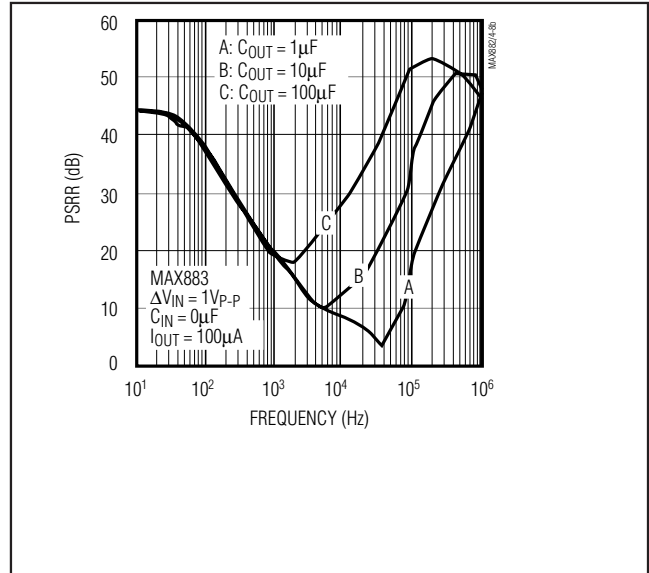

Figure 8b. Power-Supply Rejection Ratio vs. Ripple Frequency for Various Output Capacitances

Noise

The MAX882/MAX883/MAX884 exhibit up to 4mV_{p-p} of noise during normal operation. This is negligible in most applications. When using the MAX882/MAX883/MAX884 for applications that include analog-to-digital converters (ADCs) with resolutions greater than 12 bits, consider the ADC's power-supply rejection specifications. See the output noise plot in the *Typical Operating Characteristics* section.

PSRR and Operation from Sources Other than Batteries

The MAX882/MAX883/MAX884 are designed to achieve low dropout voltages and low quiescent currents in battery-powered systems. However, to gain these benefits, the devices must trade away power-supply noise rejection, as well as swift response to supply variations and load transients. For a 1mA load current, power-supply rejection ranges from 60dB down to 20dB at 2kHz. At higher frequencies, the circuit depends primarily on the characteristics of the output capacitor, and the PSRR increases (Figure 8).

5V/3.3V or Adjustable, Low-Dropout, Low IQ, 200mA Linear Regulators

MAX882/MAX883/MAX884

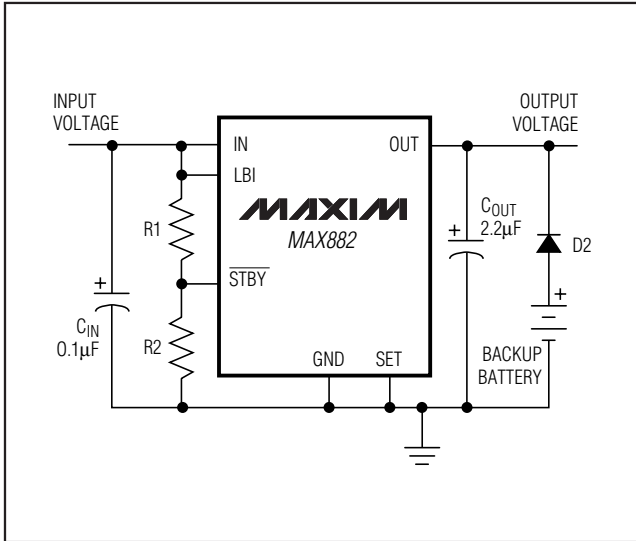

Figure 9. Short-Term Battery Backup Using the MAX882

When operating from sources other than batteries, supply-noise rejection and transient response can be improved by increasing the values of the input and output capacitors and employing passive filtering techniques. Do not use power supplies with ripple voltage exceeding 200mV at 100kHz.

Overshoot and Transient Considerations

The *Typical Operating Characteristics* section shows power-up, supply, and load-transient response graphs. On the load-transient graphs, two components of the output response can be observed: a DC shift from the output impedance due to the different load currents, and the transient response. Typical transients for step changes in the load current from 50mA to 250mA are 200mV. Increasing the output capacitor's value attenuates transient spikes.

During recovery from shutdown, overshoot is negligible if the output voltage has been given time to decay adequately. During power-up from $V_{IN} = 0$, overshoot is typically less than 1% of V_{OUT} .

Input-Output (Dropout) Voltage

A regulator's minimum input-output voltage differential (or dropout voltage) determines the lowest usable supply voltage. In battery-powered systems, this determines the useful end-of-life battery voltage. Because the MAX882/MAX883/MAX884 use a p-channel MOSFET pass transistor, their dropout voltage is a function of $R_{DS(ON)}$ multiplied by the load current (see *Electrical Characteristics*). Quickly stepping up the input voltage from the dropout voltage can result in overshoot.

Short-Term Battery Backup Using the MAX882

Figure 9 illustrates a scheme for implementing battery backup for 3.3V circuits using the MAX882. When the supply voltage drops below some user-specified value based on resistors R1 and R2, the standby function activates, turning off the MAX882's output. Under these conditions, the backup battery supplies power to the load. Reverse current protection prevents the battery from draining back through the regulator to the input.

This application is limited to short-term battery backup for 3.3V circuits. The current drawn by the MAX882's OUT pin at 3.3V during reverse-current protection is typically 8µA. It should not be used with the MAX883 and MAX884, since the OFF pin is a logic input, and indeterminate inputs can cause the regulator to turn on intermittently, draining the battery.

Reverse Battery Protection

Reverse battery protection can be added by including an inexpensive Schottky diode between the battery input and the regulator circuit, as shown in Figure 7. However, the dropout voltage of the regulator will be increased by the forward voltage drop of the diode. For example, the forward voltage of a standard 1N5817 Schottky diode is typically 0.29V at 200mA.

5V/3.3V or Adjustable, Low-Dropout, Low IQ, 200mA Linear Regulators

Ordering Information (continued)

PART	TEMP RANGE	PIN-PACKAGE
MAX883CPA	0°C to +70°C	8 PDIP
MAX883CSA	0°C to +70°C	8 SO
MAX883C/D	0°C to +70°C	Dice*
MAX883EPA	-40°C to +85°C	8 PDIP
MAX883ESA	-40°C to +85°C	8 SO
MAX883MPA/PR	-55°C to +125°C	8 PDIP
MAX884CPA	0°C to +70°C	8 PDIP
MAX884CSA	0°C to +70°C	8 SO
MAX884C/D	0°C to +70°C	Dice*
MAX884EPA	-40°C to +85°C	8 PDIP
MAX884ESA	-40°C to +85°C	8 SO

*Dice are tested at $T_J = +25^\circ\text{C}$, DC parameters only.

**Contact factory for availability.

Chip Topography

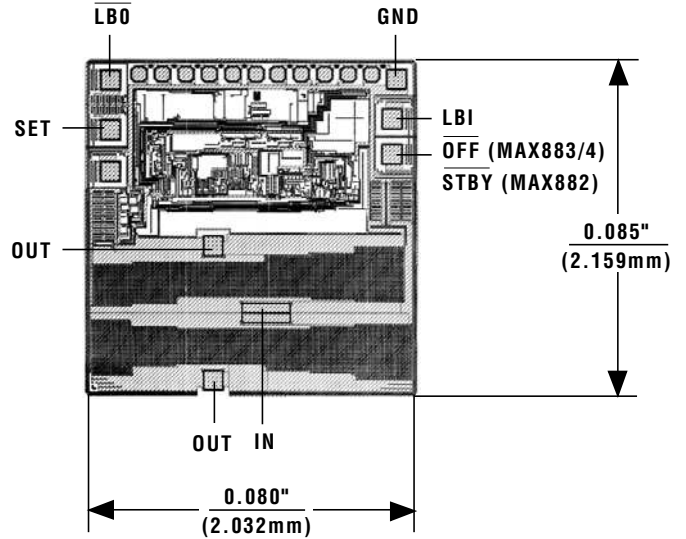

NO DIRECT SUBSTRATE CONNECTION. THE N-SUBSTRATE IS INTERNALLY SWITCHED BETWEEN THE MORE POSITIVE OF IN OR OUT.

5V/3.3V or Adjustable, Low-Dropout, Low IQ, 200mA Linear Regulators

Package Information

For the latest package outline information and land patterns, go to www.maxim-ic.com/packages. Note that a "+", "#", or "-" in the package code indicates RoHS status only. Package drawings may show a different suffix character, but the drawing pertains to the package regardless of RoHS status.

PACKAGE TYPE	PACKAGE CODE	DOCUMENT NO.
8 PDIP	P8-T	21-0043
8 SO	S8-6F	21-0041

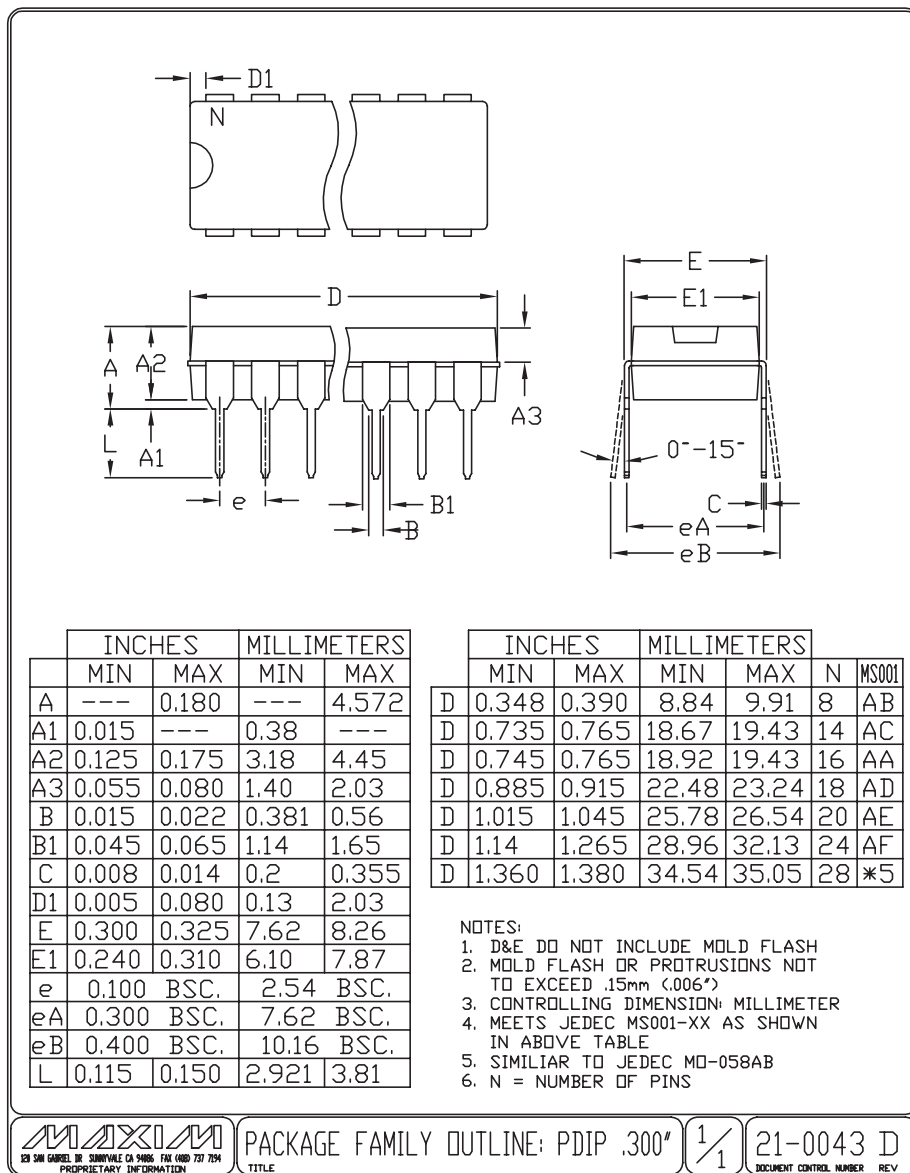

MAX882/MAX883/MAX884

5V/3.3V or Adjustable, Low-Dropout, Low IQ, 200mA Linear Regulators

Package Information (continued)

For the latest package outline information and land patterns, go to www.maxim-ic.com/packages. Note that a "+", "#", or "-" in the package code indicates RoHS status only. Package drawings may show a different suffix character, but the drawing pertains to the package regardless of RoHS status.

SOICN, EPS

DIM	INCHES		MILLIMETERS	
	MIN	MAX	MIN	MAX
A	0.053	0.069	1.35	1.75
A1	0.004	0.010	0.10	0.25
B	0.014	0.019	0.35	0.49
C	0.007	0.010	0.19	0.25
e	0.050 BSC		1.27 BSC	
E	0.150	0.157	3.80	4.00
H	0.228	0.244	5.80	6.20
L	0.016	0.050	0.40	1.27

VARIATIONS:

DIM	INCHES		MILLIMETERS		N	MS012
	MIN	MAX	MIN	MAX		
D	0.189	0.197	4.80	5.00	8	AA
D	0.337	0.344	8.55	8.75	14	AB
D	0.386	0.394	9.80	10.00	16	AC

NOTES:

- D&E DO NOT INCLUDE MOLD FLASH.
- MOLD FLASH OR PROTRUSIONS NOT TO EXCEED 0.15mm (.006").
- LEADS TO BE COPLANAR WITHIN 0.10mm (.004").
- CONTROLLING DIMENSION: MILLIMETERS.
- MEETS JEDEC MS012.
- N = NUMBER OF PINS.

PROPRIETARY INFORMATION

TITLE:
PACKAGE OUTLINE, .150" SOIC

APPROVAL	DOCUMENT CONTROL NO. 21-0041	REV. B	1/1
----------	---------------------------------	-----------	-----

5V/3.3V or Adjustable, Low-Dropout, Low IQ, 200mA Linear Regulators

Revision History

REVISION NUMBER	REVISION DATE	DESCRIPTION	PAGES CHANGED
3	9/08	Added information for rugged plastic product.	14
4	7/09	Revised <i>Ordering Information</i> table.	14

MAX882/MAX883/MAX884

Maxim cannot assume responsibility for use of any circuitry other than circuitry entirely embodied in a Maxim product. No circuit patent licenses are implied. Maxim reserves the right to change the circuitry and specifications without notice at any time.

Maxim Integrated Products, 120 San Gabriel Drive, Sunnyvale, CA 94086 408-737-7600 _____ 17