



Chipsmall Limited consists of a professional team with an average of over 10 year of expertise in the distribution of electronic components. Based in Hongkong, we have already established firm and mutual-benefit business relationships with customers from,Europe,America and south Asia,supplying obsolete and hard-to-find components to meet their specific needs.

With the principle of "Quality Parts,Customers Priority,Honest Operation,and Considerate Service",our business mainly focus on the distribution of electronic components. Line cards we deal with include Microchip,ALPS,ROHM,Xilinx,Pulse,ON,Everlight and Freescale. Main products comprise IC,Modules,Potentiometer,IC Socket,Relay,Connector.Our parts cover such applications as commercial,industrial, and automotives areas.

We are looking forward to setting up business relationship with you and hope to provide you with the best service and solution. Let us make a better world for our industry!



## Contact us

Tel: +86-755-8981 8866 Fax: +86-755-8427 6832

Email & Skype: info@chipsmall.com Web: www.chipsmall.com

Address: A1208, Overseas Decoration Building, #122 Zhenhua RD., Futian, Shenzhen, China



## MAX9025–MAX9028

## UCSP, 1.8V, Nanopower, Beyond-the-Rails Comparators With/Without Reference

### General Description

The MAX9025/MAX9028 nanopower comparators in space-saving chip-scale (UCSP™) packages feature Beyond-the-Rails™ inputs and are guaranteed to operate down to +1.8V. The MAX9025/MAX9026 feature an on-board 1.236V ±1% reference and draw an ultra-low supply current of only 1µA, while the MAX9027–MAX9028 (without reference) require just 0.6µA of supply current. These features make the MAX9025–MAX9028 family of comparators ideal for all 2-cell battery-monitoring/management applications.

The unique design of the output stage limits supply-current surges while switching, virtually eliminating the supply glitches typical of many other comparators. This design also minimizes overall power consumption under dynamic conditions. The MAX9025/MAX9027 have a push-pull output stage that sinks and sources current. Large internal-output drivers allow rail-to-rail output swing with loads up to 5mA. The MAX9026/MAX9028 have an open-drain output stage that makes them suitable for mixed-voltage system design. All devices are available in the miniature 6-bump UCSP packages.

Refer to the MAX9117 data sheet for similar comparators in 5-pin SC70 packages and the MAX9017 data sheet for similar dual comparators in 8-pin SOT23 packages.

### Applications

- 2-Cell Battery Monitoring/Management
- Ultra-Low-Power Systems
- Mobile Communications
- Notebooks and PDAs
- Sensing at Ground or Supply Line
- Telemetry and Remote Systems
- Medical Instruments

### Selector Guide

PART	INTERNAL REFERENCE	OUTPUT TYPE	SUPPLY CURRENT (µA)
MAX9025	Yes	Push-Pull	1.0
MAX9026	Yes	Open-Drain	1.0
MAX9027	No	Push-Pull	0.6
MAX9028	No	Open-Drain	0.6

**Typical Application Circuit appears at end of data sheet.**

Beyond-the-Rails and UCSP are trademarks of Maxim Integrated Products, Inc.

### Features

- Space-Saving UCSP Package (1mm x 1.52mm)
- Ultra-Low Supply Current
  - 0.6µA (MAX9027/MAX9028)
  - 1µA with Reference (MAX9025/MAX9026)
- Guaranteed to Operate Down to +1.8V
- Internal 1.236V ±1% Reference (MAX9025/MAX9026)
- Input Voltage Range Extends 200mV Beyond-the-Rails
- CMOS Push-Pull Output with ±5mA Drive Capability (MAX9025/MAX9027)
- Open-Drain Output Versions Available (MAX9026/MAX9028)
- Crowbar-Current-Free Switching
- Internal Hysteresis for Clean Switching
- No Phase Reversal for Overdriven Inputs

### Ordering Information

PART	TEMP RANGE	BUMP-PACKAGE	TOP MARK
MAX9025EBT+T	-40°C to +85°C	6 UCSP	ADB
MAX9026EBT+T	-40°C to +85°C	6 UCSP	ADC
MAX9027EBT+T	-40°C to +85°C	6 UCSP	ADD
MAX9028EBT+T	-40°C to +85°C	6 UCSP	ADE

+Denotes lead(Pb)-free/RoHS-compliant package.

T = Tape and reel.

### Pin Configurations

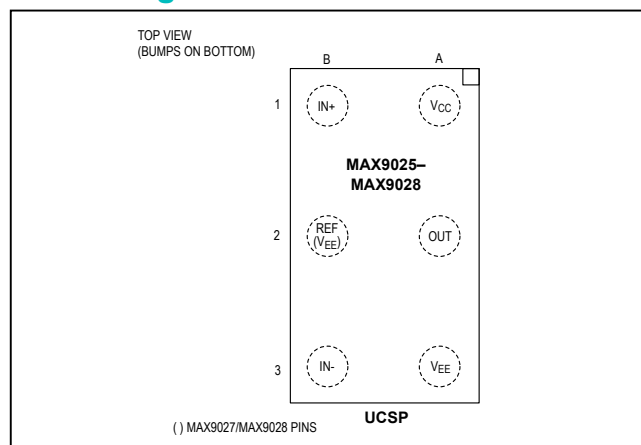

**Absolute Maximum Ratings**

Supply Voltage ( $V_{CC}$ to $V_{EE}$ ) .....	+6V	Output Short-Circuit Duration .....	10s
Voltage Inputs (IN+, IN-, REF) .....	( $V_{EE} - 0.3V$ ) to ( $V_{CC} + 0.3V$ )	Continuous Power Dissipation ( $T_A = +70^\circ C$ ) .....	
Output Voltage .....		6-Bump UCSP (derate 3.9mW/ $^\circ C$ above $+70^\circ C$ ) .....	308mW
MAX9025/MAX9027 .....	( $V_{EE} - 0.3V$ ) to ( $V_{CC} + 0.3V$ )	Operating Temperature Range .....	-40 $^\circ C$ to +85 $^\circ C$
MAX9026/MAX9028 .....	( $V_{EE} - 0.3V$ ) to +6V	Junction Temperature .....	+150 $^\circ C$
Current into Input Pins .....	20mA	Storage Temperature Range .....	-65 $^\circ C$ to +150 $^\circ C$
Output Current .....	$\pm 50mA$	Bump Temperature (soldering) Reflow .....	+235 $^\circ C$

Stresses beyond those listed under "Absolute Maximum Ratings" may cause permanent damage to the device. These are stress ratings only, and functional operation of the device at these or any other conditions beyond those indicated in the operational sections of the specifications is not implied. Exposure to absolute maximum rating conditions for extended periods may affect device reliability.

**Electrical Characteristics-MAX9025/MAX9026 (with REF)**

( $V_{CC} = +5V$ ,  $V_{EE} = 0V$ ,  $V_{IN+} = V_{REF}$ ,  $T_A = -40^\circ C$  to  $+85^\circ C$ , unless otherwise noted. Typical values are at  $T_A = +25^\circ C$ .) (Note 1)

PARAMETER	SYMBOL	CONDITIONS	MIN	TYP	MAX	UNITS	
Supply Voltage Range	$V_{CC}$	Inferred from the PSRR test	1.8		5.5	V	
Supply Current	$I_{CC}$	$V_{CC} = 1.8V$		0.8	1.5	$\mu A$	
		$V_{CC} = 5V$	$T_A = +25^\circ C$		1.0		1.7
			$T_A = T_{MIN}$ to $T_{MAX}$				2.2
IN+ Voltage Range	$V_{IN+}$	Inferred from output swing test	$V_{EE} - 0.2$		$V_{CC} + 0.2$	V	
Input Offset Voltage	$V_{OS}$	(Note 2)	$T_A = +25^\circ C$	0.3	5	mV	
			$T_A = T_{MIN}$ to $T_{MAX}$		10		
Input-Referred Hysteresis	$V_{HB}$	(Note 3)		4		mV	
Input Bias Current	$I_B$	$T_A = +25^\circ C$		0.15	1	nA	
		$T_A = T_{MIN}$ to $T_{MAX}$			2		
Power-Supply Rejection Ratio	PSRR	$V_{CC} = 1.8V$ to $5.5V$		0.1	1	mV/V	
Output Voltage Swing High	$V_{CC} - V_{OH}$	MAX9025, $V_{CC} = 5V$ , $I_{SOURCE} = 6mA$	$T_A = +25^\circ C$	250	350	mV	
			$T_A = T_{MIN}$ to $T_{MAX}$		450		
		MAX9025, $V_{CC} = 1.8V$ , $I_{SOURCE} = 1mA$	$T_A = +25^\circ C$	56	200		
			$T_A = T_{MIN}$ to $T_{MAX}$		300		
Output Voltage Swing Low	$V_{OL}$	$V_{CC} = 5V$ , $I_{SINK} = 6mA$	$T_A = +25^\circ C$	250	350	mV	
			$T_A = T_{MIN}$ to $T_{MAX}$		450		
		$V_{CC} = 1.8V$ , $I_{SINK} = 1mA$	$T_A = +25^\circ C$	57	200		
			$T_A = T_{MIN}$ to $T_{MAX}$		300		
Output Leakage Current	$I_{LEAK}$	MAX9026 only, $V_O = 5.5V$		0.001	1	$\mu A$	
Output Short-Circuit Current	$I_{SC}$	Sourcing, $V_O = V_{EE}$	$V_{CC} = 5V$	35		mA	
			$V_{CC} = 1.8V$	3			
		Sinking, $V_O = V_{CC}$	$V_{CC} = 5V$	33			
			$V_{CC} = 1.8V$	3			

**Electrical Characteristics-MAX9025/MAX9026 (with REF) (continued)**(V<sub>CC</sub> = +5V, V<sub>EE</sub> = 0V, V<sub>IN+</sub> = V<sub>REF</sub>, T<sub>A</sub> = -40°C to +85°C, unless otherwise noted. Typical values are at T<sub>A</sub> = +25°C.) (Note 1)

PARAMETER	SYMBOL	CONDITIONS		MIN	TYP	MAX	UNITS
High-to-Low Propagation Delay (Note 4)	t <sub>PD-</sub>	V <sub>CC</sub> = 1.8V			7		μs
		V <sub>CC</sub> = 5V			6		
Low-to-High Propagation Delay (Note 4)	t <sub>PD+</sub>	MAX9025 only	V <sub>CC</sub> = 1.8V		11		μs
			V <sub>CC</sub> = 5V		28		
		MAX9026 only, R <sub>PULLUP</sub> = 100kΩ	V <sub>CC</sub> = 1.8V		12		
			V <sub>CC</sub> = 5V		31		
Rise Time	t <sub>RISE</sub>	MAX9025 only, C <sub>L</sub> = 15pF			1.6		μs
Fall Time	t <sub>FALL</sub>	C <sub>L</sub> = 15pF			0.2		μs
Power-Up Time	t <sub>ON</sub>				1.2		ms
Reference Voltage	V <sub>REF</sub>	T <sub>A</sub> = +25°C		1.224	1.236	1.248	V
		T <sub>A</sub> = T <sub>MIN</sub> to T <sub>MAX</sub>		1.205		1.267	
Reference Voltage Temperature Coefficient	T <sub>CREF</sub>				40		ppm/ °C
Reference Output Voltage Noise	EN	C <sub>REF</sub> = 1nF	BW = 10Hz to 100kHz		29		μV <sub>RMS</sub>
			BW = 10Hz to 6kHz		60		
Reference Line Regulation	$\frac{\Delta V_{REF}}{\Delta V_{CC}}$	V <sub>CC</sub> = 1.8V to 5.5V			0.5		mV/V
Reference Load Regulation	$\frac{\Delta V_{REF}}{\Delta I_{OUT}}$	ΔI <sub>OUT</sub> = 0nA to 100nA			0.03		mV/ nA

**Electrical Characteristics-MAX9027/MAX9028 (without REF)**(V<sub>CC</sub> = +5V, V<sub>EE</sub> = 0V, V<sub>CM</sub> = 0V, T<sub>A</sub> = -40°C to +85°C, unless otherwise noted. Typical values are at T<sub>A</sub> = +25°C.) (Note 1)

PARAMETER	SYMBOL	CONDITIONS		MIN	TYP	MAX	UNITS
Supply Voltage Range	V <sub>CC</sub>	Inferred from the PSRR test		1.8		5.5	V
Supply Current	I <sub>CC</sub>	V <sub>CC</sub> = 1.8V			0.45	0.75	μA
		V <sub>CC</sub> = 5V	T <sub>A</sub> = +25°C		0.6	1.0	
			T <sub>A</sub> = T <sub>MIN</sub> to T <sub>MAX</sub>			1.25	
Input Common-Mode Voltage Range	V <sub>CM</sub>	Inferred from the CMRR test		V <sub>EE</sub> - 0.2		V <sub>CC</sub> + 0.2	V
Input Offset Voltage	V <sub>OS</sub>	-0.2V ≤ V <sub>CM</sub> ≤ (V <sub>CC</sub> + 0.2V) (Note 2)	T <sub>A</sub> = +25°C		0.3	5	mV
			T <sub>A</sub> = T <sub>MIN</sub> to T <sub>MAX</sub>			10	
Input-Referred Hysteresis	V <sub>HB</sub>	-0.2V ≤ V <sub>CM</sub> ≤ (V <sub>CC</sub> + 0.2V) (Note 3)			4		mV
Input Bias Current	I <sub>B</sub>	T <sub>A</sub> = +25°C			0.15	1	nA
		T <sub>A</sub> = T <sub>MIN</sub> to T <sub>MAX</sub>				2	
Power-Supply Rejection Ratio	PSRR	V <sub>CC</sub> = 1.8V to 5.5V			0.1	1	mV/V
Common-Mode Rejection Ratio	CMRR	(V <sub>EE</sub> - 0.2V) ≤ V <sub>CM</sub> ≤ (V <sub>CC</sub> + 0.2V)			0.5	3	mV/V

## Electrical Characteristics-MAX9027/MAX9028 (without REF) (continued)

(V<sub>CC</sub> = +5V, V<sub>EE</sub> = 0V, V<sub>CM</sub> = 0V, T<sub>A</sub> = -40°C to +85°C, unless otherwise noted. Typical values are at T<sub>A</sub> = +25°C.) (Note 1)

PARAMETER	SYMBOL	CONDITIONS		MIN	TYP	MAX	UNITS
Output Voltage Swing High	V <sub>CC</sub> - V <sub>OH</sub>	MAX9027 only, V <sub>CC</sub> = 5V, I <sub>SOURCE</sub> = 5mA	T <sub>A</sub> = +25°C	191	400	mV	
			T <sub>A</sub> = T <sub>MIN</sub> to T <sub>MAX</sub>	500			
		MAX9028 only, V <sub>CC</sub> = 1.8V, I <sub>SOURCE</sub> = 1mA	T <sub>A</sub> = +25°C	58	200		
			T <sub>A</sub> = T <sub>MIN</sub> to T <sub>MAX</sub>	300			
Output Voltage Swing Low	V <sub>OL</sub>	V <sub>CC</sub> = 5V, I <sub>SINK</sub> = 5mA	T <sub>A</sub> = +25°C	191	400	mV	
			T <sub>A</sub> = T <sub>MIN</sub> to T <sub>MAX</sub>	500			
		V <sub>CC</sub> = 1.8V, I <sub>SINK</sub> = 1mA	T <sub>A</sub> = +25°C	56	200		
			T <sub>A</sub> = T <sub>MIN</sub> to T <sub>MAX</sub>	300			
Output Leakage Current	I <sub>LEAK</sub>	MAX9028 only, V <sub>O</sub> = 5.5V		0.001	1	μA	
Output Short-Circuit Current	I <sub>SC</sub>	Sourcing, V <sub>O</sub> = V <sub>EE</sub>	V <sub>CC</sub> = 5V	35	mA		
			V <sub>CC</sub> = 1.8V	3			
		Sourcing, V <sub>O</sub> = V <sub>CC</sub>	V <sub>CC</sub> = 5V	33			
			V <sub>CC</sub> = 1.8V	3			
High-to-Low Propagation Delay (Note 4)	t <sub>PD-</sub>		V <sub>CC</sub> = 1.8V	16	μs		
			V <sub>CC</sub> = 5V	14			
Low-to-High Propagation Delay (Note 4)	t <sub>PD+</sub>	MAX9027 only	V <sub>CC</sub> = 1.8V	15	μs		
			V <sub>CC</sub> = 5V	40			
		MAX9028 only	V <sub>CC</sub> = 1.8V, R <sub>PULLUP</sub> = 100kΩ	16			
			V <sub>CC</sub> = 5V, R <sub>PULLUP</sub> = 100kΩ	45			
Rise Time	t <sub>RISE</sub>	MAX9027 only, C <sub>L</sub> = 15pF		1.6	μs		
Fall Time	t <sub>FALL</sub>	C <sub>L</sub> = 15pF		0.2	μs		
Power-Up Time	t <sub>ON</sub>			1.2	ms		

**Note 1:** All specifications are 100% tested at T<sub>A</sub> = +25°C. Specification limits over temperature (T<sub>A</sub> = T<sub>MIN</sub> to T<sub>MAX</sub>) are guaranteed by design, not production tested.

**Note 2:** V<sub>OS</sub> is defined as the center of the hysteresis band at the input.

**Note 3:** The hysteresis-related trip points are defined as the edges of the hysteresis band, measured with respect to the center of the band (i.e., V<sub>OS</sub>) (Figure 2).

**Note 4:** Specified with an input overdrive (V<sub>OVERDRIVE</sub>) of 100mV, and load capacitance of C<sub>L</sub> = 15pF. V<sub>OVERDRIVE</sub> is defined above and beyond the offset voltage and hysteresis of the comparator input. For the MAX9025/MAX9026, reference voltage error should also be added.

Typical Operating Characteristics

( $V_{CC} = +5V$ ,  $V_{EE} = 0V$ ,  $C_L = 15pF$ ,  $V_{OVERDRIVE} = 100mV$ ,  $T_A = +25^\circ C$ , unless otherwise noted.)

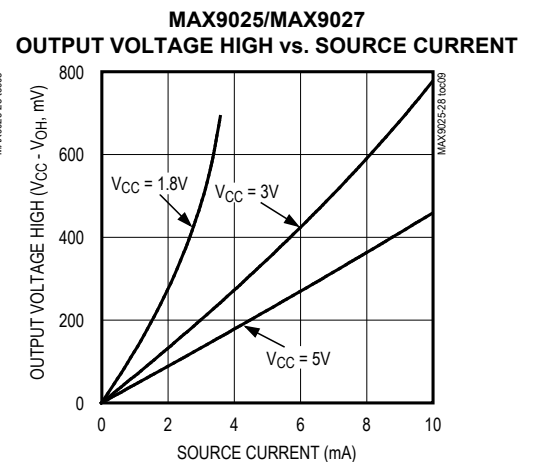
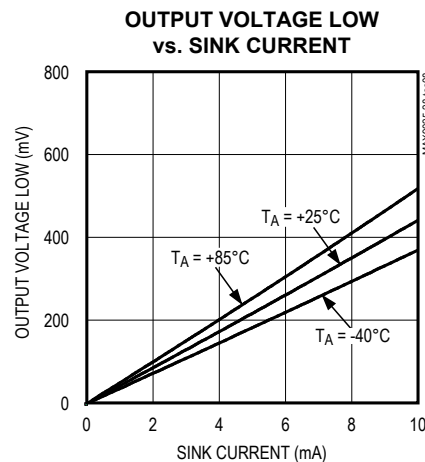
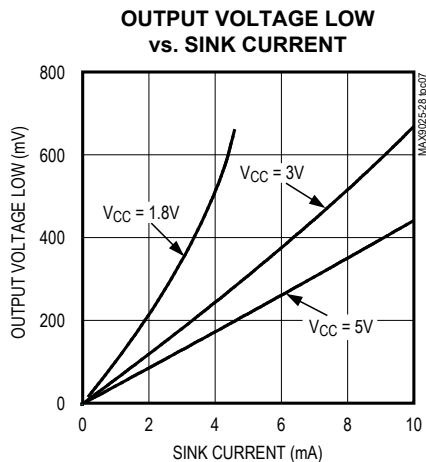
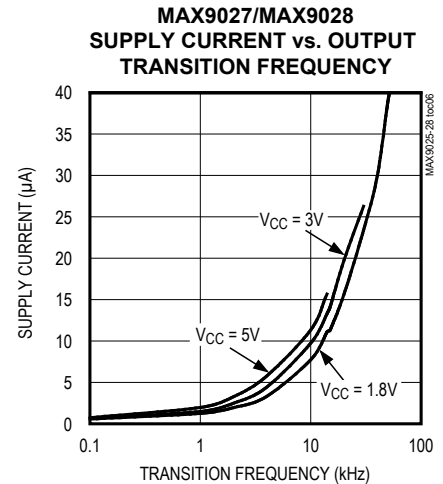
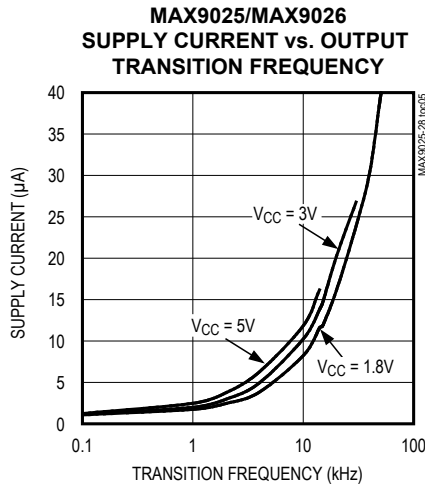
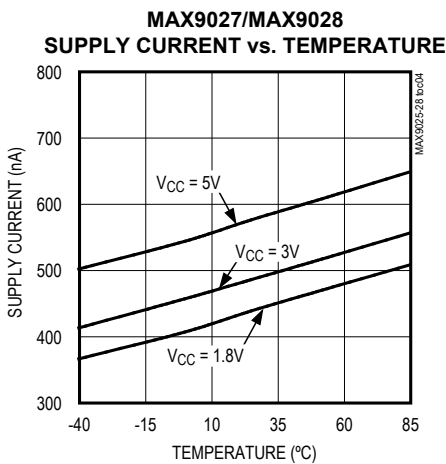
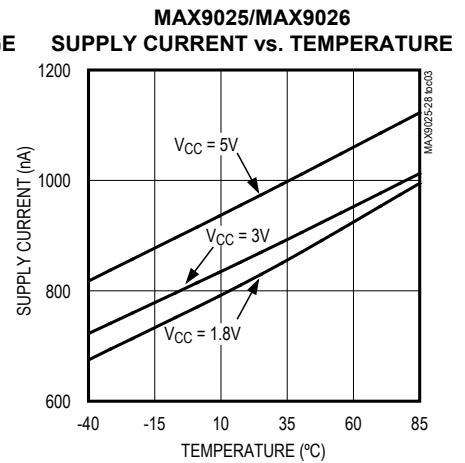
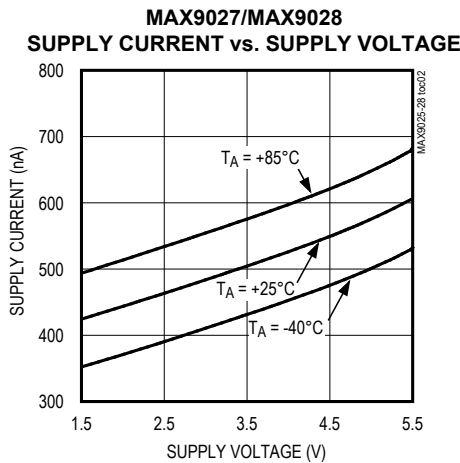
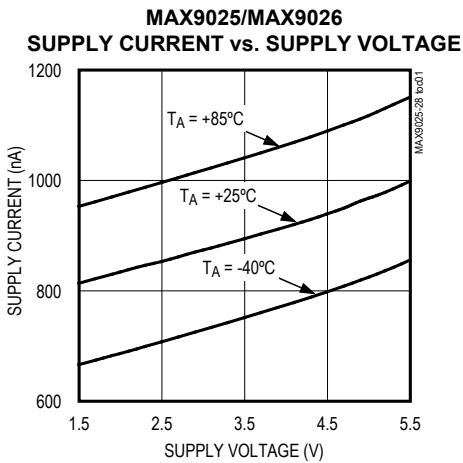

Typical Operating Characteristics (continued)

( $V_{CC} = +5V$ ,  $V_{EE} = 0V$ ,  $C_L = 15pF$ ,  $V_{OVERDRIVE} = 100mV$ ,  $T_A = +25^\circ C$ , unless otherwise noted.)

MAX9025/MAX9027  
OUTPUT VOLTAGE HIGH vs. SOURCE CURRENT

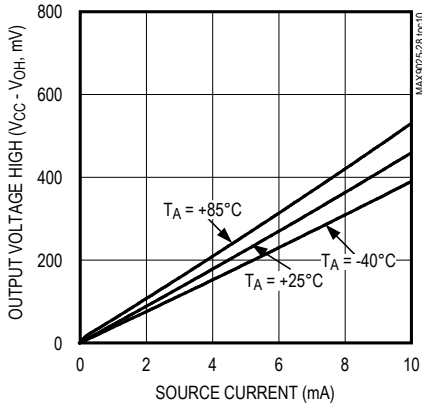

SHORT-CIRCUIT SINK CURRENT vs. TEMPERATURE

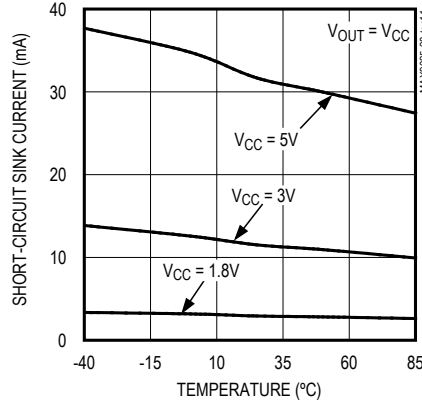

MAX9025/MAX9027 SHORT-CIRCUIT SOURCE CURRENT vs. TEMPERATURE

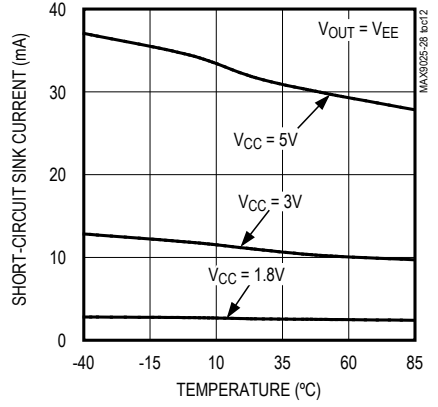

OFFSET VOLTAGE vs. TEMPERATURE

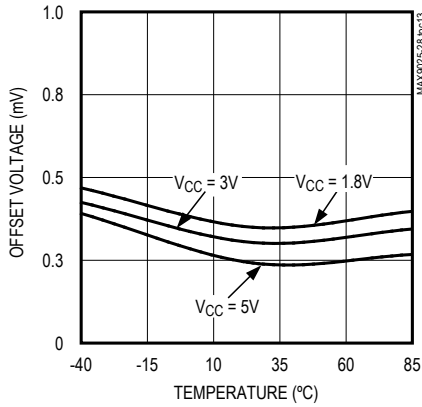

HYSTERESIS VOLTAGE vs. TEMPERATURE

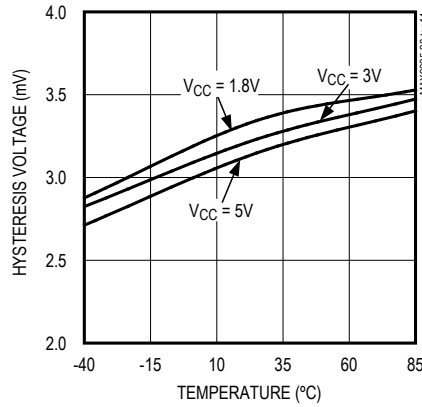

INPUT BIAS CURRENT vs. INPUT BIAS VOLTAGE

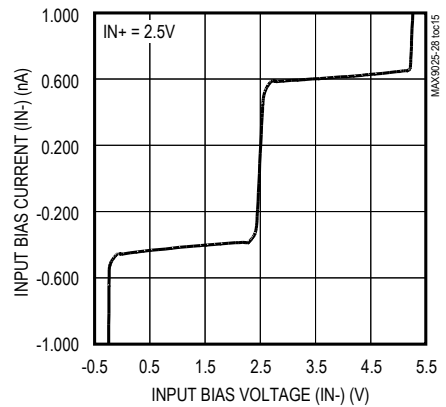

MAX9025/MAX9026  
REFERENCE VOLTAGE vs. TEMPERATURE

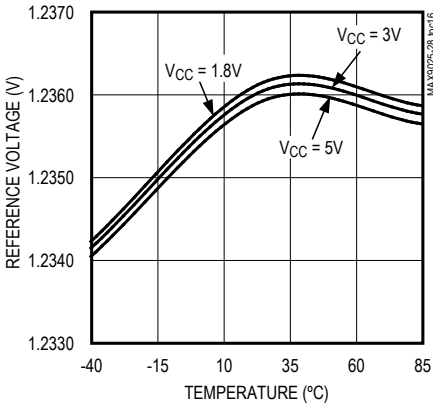

MAX9025/MAX9026  
REFERENCE VOLTAGE vs. TEMPERATURE

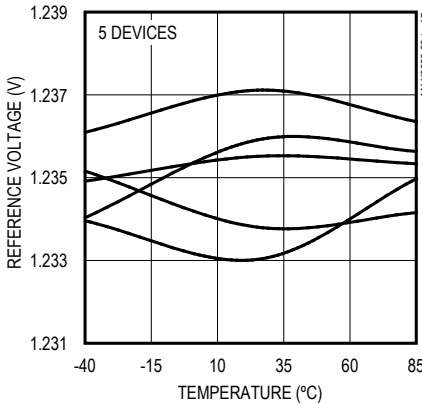

MAX9025/MAX9026  
REFERENCE VOLTAGE vs. SUPPLY VOLTAGE

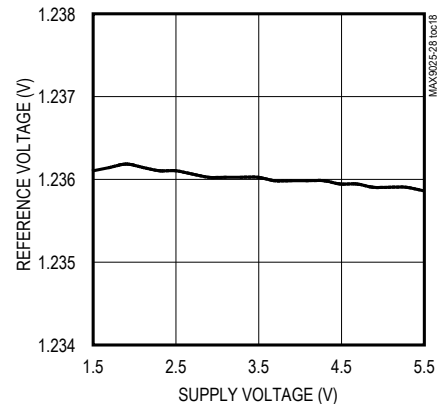

Typical Operating Characteristics (continued)

( $V_{CC} = +5V$ ,  $V_{EE} = 0V$ ,  $C_L = 15pF$ ,  $V_{OVERDRIVE} = 100mV$ ,  $T_A = +25^\circ C$ , unless otherwise noted.)

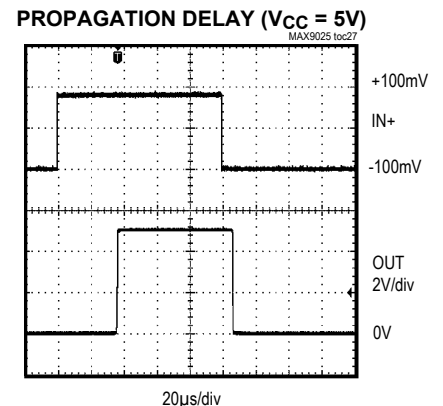
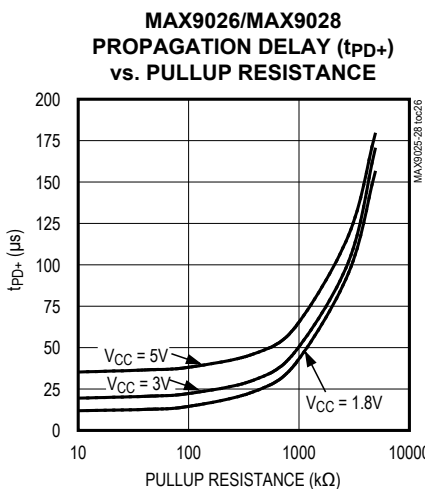
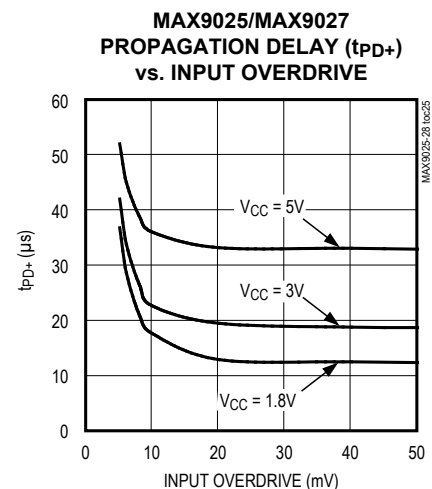
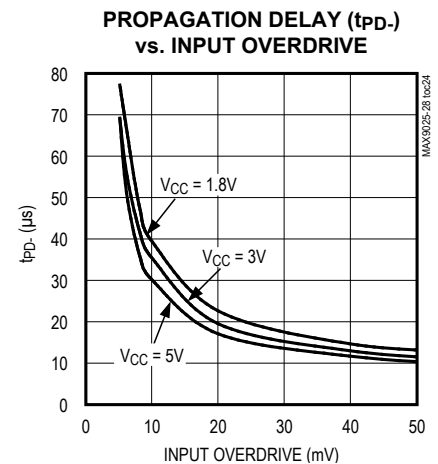
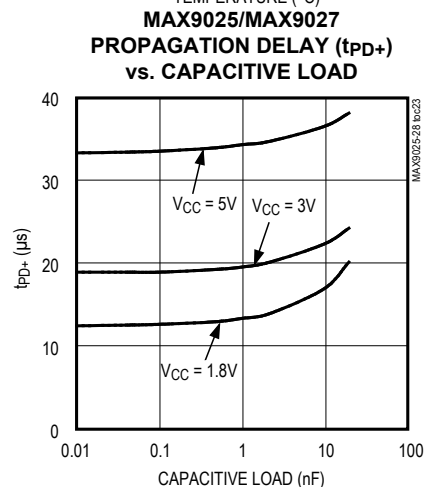
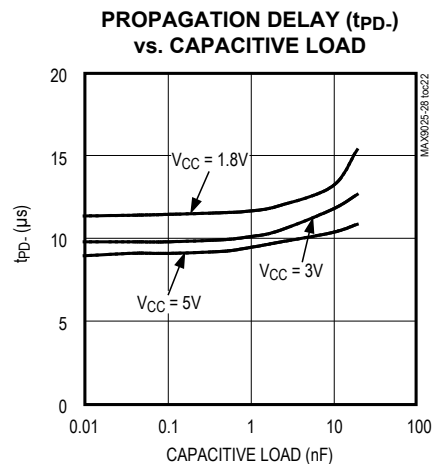
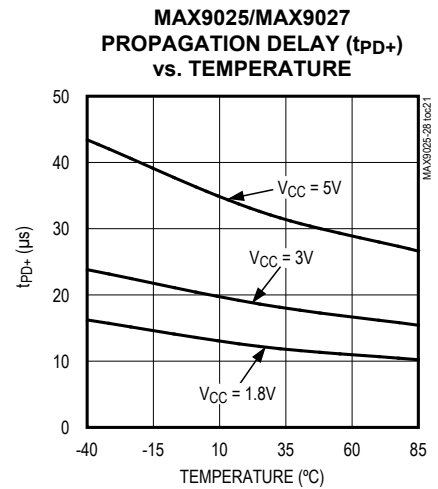
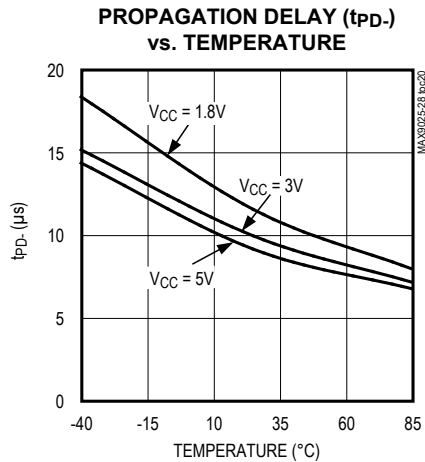
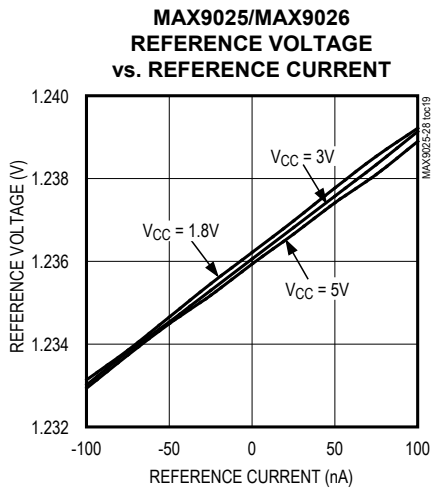



Typical Operating Characteristics (continued)

( $V_{CC} = +5V$ ,  $V_{EE} = 0V$ ,  $C_L = 15pF$ ,  $V_{OVERDRIVE} = 100mV$ ,  $T_A = +25^\circ C$ , unless otherwise noted.)

PROPAGATION DELAY ( $V_{CC} = 3V$ )

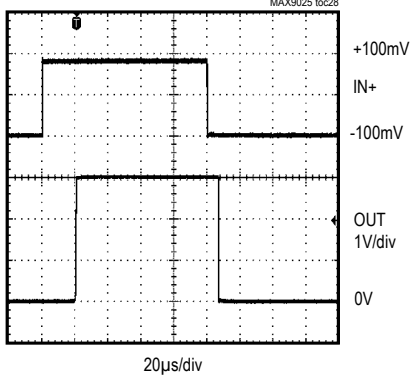

PROPAGATION DELAY ( $V_{CC} = 1.8V$ )

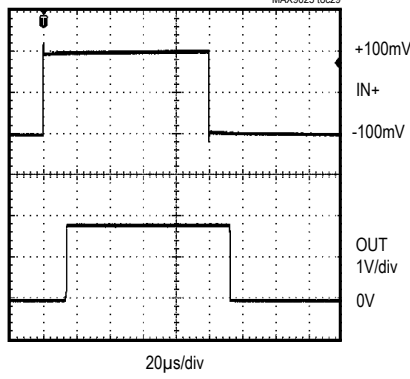

1kHz FREQUENCY RESPONSE  
( $V_{CC} = 5V$ )

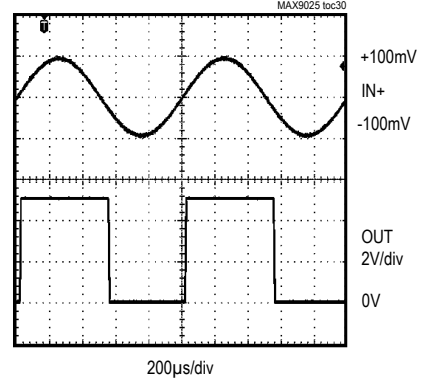

10kHz FREQUENCY RESPONSE  
( $V_{CC} = 1.8V$ )

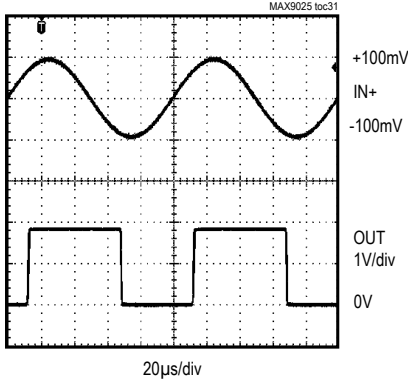

REFERENCE RESPONSE TO SUPPLY  
VOLTAGE TRANSIENT ( $C_{REF} = 10nF$ )

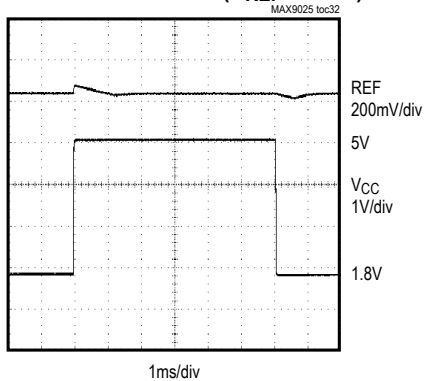

POWER-UP/POWER-DOWN RESPONSE

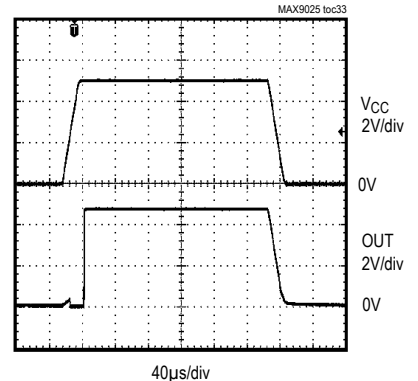

Functional Diagrams

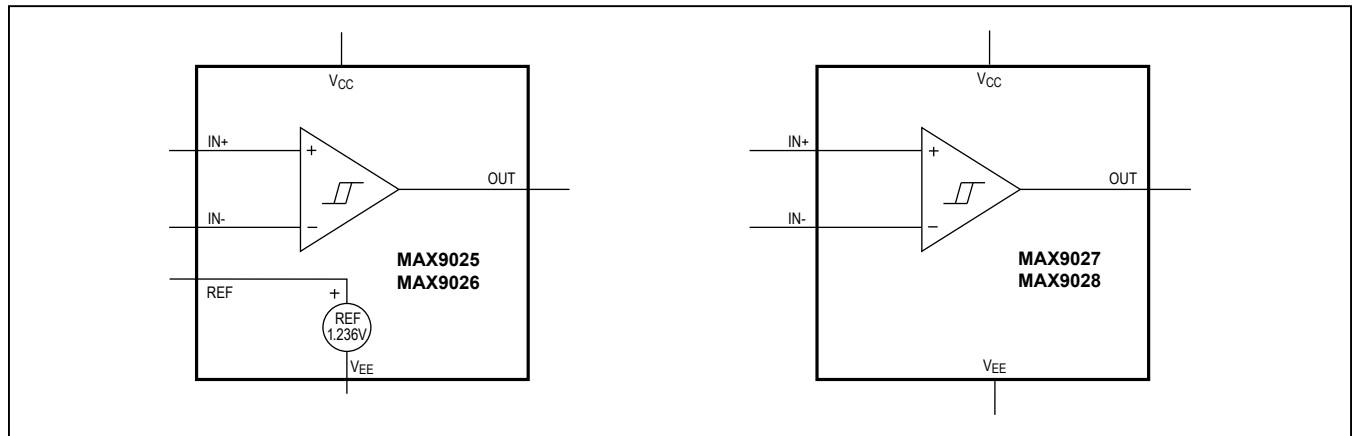

Pin Description

PIN		NAME	FUNCTION
MAX9025/ MAX9026	MAX9027/ MAX9028		
A2	A2	OUT	Comparator Output
A3	A3, B2	V <sub>EE</sub>	Negative Supply Voltage
B1	B1	IN+	Comparator Noninverting Input
B2	—	REF	1.236V Reference Output
A1	A1	V <sub>CC</sub>	Positive Supply Voltage
B3	B3	IN-	Comparator Inverting Input

Detailed Description

The MAX9025/MAX9026 feature an on-board 1.236V ±1% reference, yet draw an ultra-low supply current of 1.0µA. The MAX9027/MAX9028 (without reference) consume just 0.6µA of supply current. All four devices are guaranteed to operate down to +1.8V. Their common-mode input voltage range extends 200mV beyond-the-rails. Internal hysteresis ensures clean output switching, even with slow-moving input signals. Large internal output drivers allow rail-to-rail output swing with up to ±5mA loads.

The output stage employs a unique design that minimizes supply-current surges while switching, virtually eliminating the supply glitches typical of many other comparators. The MAX9025/MAX9027 have a push-pull output stage that sinks as well as sources current. The MAX9026/

MAX9028 have an open-drain output stage that can be pulled beyond V<sub>CC</sub> to a maximum of 5.5V above V<sub>EE</sub>. These open-drain versions are ideal for implementing wire-OR output logic functions.

Input Stage Circuitry

The input common-mode voltage range extends from V<sub>EE</sub> - 0.2V to V<sub>CC</sub> + 0.2V. These comparators operate at any differential input voltage within these limits. Input bias current is typically ±0.15nA if the input voltage is between the supply rails. Comparator inputs are protected from overvoltage by internal ESD protection diodes connected to the supply rails. As the input voltage exceeds the supply rails, these ESD protection diodes become forward biased and begin to conduct.

Output Stage Circuitry

The MAX9025–MAX9028 contain a unique break-before-make output stage capable of rail-to-rail operation with up to ±5mA loads. Many comparators consume orders of magnitude more current during switching than during steady-state operation. However, with this family of comparators, the supply-current change during an output transition is extremely small. In the *Typical Operating Characteristics*, the Supply Current vs. Output Transition Frequency graphs show the minimal supply-current increase as the output switching frequency approaches 1kHz. This characteristic reduces the need for power-supply filter capacitors to reduce glitches created by comparator switching currents. In battery-powered applications, this characteristic results in a substantial increase in battery life.

**Reference (MAX9025/MAX9026)**

The MAX9025–MAX9028s’ internal +1.236V reference has a typical temperature coefficient of 40ppm/°C over the full -40°C to +85°C temperature range. The reference is a very-low-power bandgap cell, with a typical 35kΩ output impedance. REF can source and sink up to 100nA to external circuitry. For applications needing increased drive, buffer REF with a low input-bias current op amp such as the MAX4162. Most applications require no REF bypass capacitor. For noisy environments or fast  $V_{CC}$  transients, connect a 1nF to 10nF ceramic capacitor from REF to GND.

**Applications Information**

**Low-Voltage, Low-Power Operation**

The MAX9025–MAX9028 are ideally suited for use with most battery-powered systems. Table 1 lists a variety of battery types, capacities, and approximate operating times for the MAX9025–MAX9028, assuming nominal conditions.

**Internal Hysteresis**

Many comparators oscillate in the linear region of operation because of noise or undesired parasitic feedback. This tends to occur when the voltage on one input is equal or very close to the voltage on the other input. The MAX9025–MAX9028 have internal 4mV hysteresis to counter parasitic effects and noise.

The hysteresis in a comparator creates two trip points: one for the rising input voltage ( $V_{THR}$ ) and one for the falling input voltage ( $V_{THF}$ ) (Figure 2). The difference between the trip points is the hysteresis ( $V_{HB}$ ). When the comparator’s input voltages are equal, the hysteresis

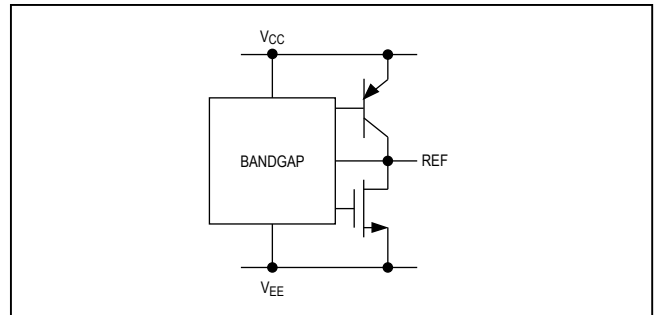

Figure 1. MAX9025/MAX9026 Voltage Reference Output Equivalent Circuit

effectively causes one comparator input to move quickly past the other, thus taking the input out of the region where oscillation occurs. Figure 2 illustrates the case in which  $IN-$  has a fixed voltage applied, and  $IN+$  is varied. If the inputs were reversed, the figure would be the same, except with an inverted output.

**Adding External Hysteresis**

In applications requiring more than the internal 4mV hysteresis of the MAX9025–MAX9028, additional hysteresis can be added with external components. Because the MAX9025–MAX9028 are intended for very low-power systems, care should be taken to minimize power dissipation in the additional circuitry.

Regardless of which approach is taken, the external hysteresis will be  $V_{CC}$  dependent. Over the full discharge range of battery-powered systems, the hysteresis can change as much as 40%. This must be considered during design.

**Table 1. Battery Applications Using MAX9025–MAX9028**

BATTERY TYPE	RECHARGEABLE	$V_{FRESH}$ (V)	$V_{END-OF-LIFE}$ (V)	CAPACITY, AA SIZE (mA-h)	MAX9025/MAX9026 OPERATING TIME (hr)	MAX9027/MAX9028 OPERATING TIME (hr)
Alkaline (2 Cells)	No	3.0	1.8	2000	$1.8 \times 10^6$	$2.8 \times 10^6$
Nickel-Cadmium (2 Cells)	Yes	2.4	1.8	750	680,000	$1.07 \times 10^6$
Lithium-Ion (1 Cell)	Yes	3.5	2.7	1000	$0.9 \times 10^6$	$1.4 \times 10^6$
Nickel-Metal-Hydrate (2 Cells)	Yes	2.4	1.8	1000	$0.9 \times 10^6$	$1.4 \times 10^6$

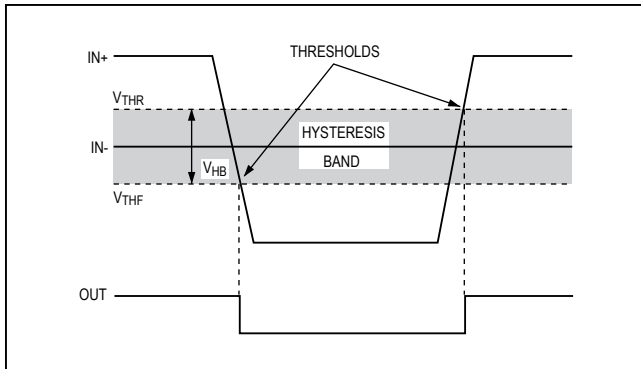

Figure 2. Threshold Hysteresis Band

**Simplest Circuit**

The simplest circuit for adding external hysteresis is shown in Figure 3. In this example, the hysteresis is defined by:

$$\text{Hysteresis} = \frac{R_S}{R_{FB}} \times V_{CC}$$

where  $R_S$  is the source resistance and  $R_{FB}$  is the feedback resistance. Because the comparison threshold is  $1/2 V_{CC}$ , the MAX9027 was chosen for its push-pull output and lack of reference. This provides symmetrical hysteresis around the threshold.

**Output Considerations**

In most cases, the push-pull outputs of the MAX9025/MAX9027 are best for external hysteresis. The open-drain output of the MAX9026/MAX9028 can be used, but the effect of the feedback network on the actual output high voltage must be considered.

**Component Selection**

Because the MAX9025–MAX9028 are intended for very low power-supply systems, the highest impedance circuits should be used wherever possible. The offset error due to input-bias current is proportional to the total impedance seen at the input. For example, selecting components for Figure 3, with a target of 50mV hysteresis, a 5V supply, and choosing an  $R_{FB}$  of 10M $\Omega$  gives  $R_S$  as 100k $\Omega$ . The total impedance seen at IN+ is therefore 10M $\Omega$  || 100k $\Omega$ , or 99k $\Omega$ . The maximum  $I_B$  of the MAX9025–MAX9028 is 2nA; therefore, the error due to source impedance is less than 400 $\mu$ V.

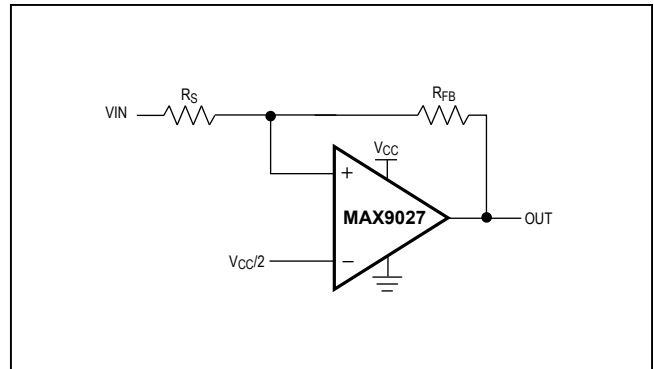

Figure 3. MAX9025/MAX9027 External Hysteresis

**Asymmetrical Hysteresis**

When the input threshold is not set at  $1/2 V_{CC}$ , the hysteresis added to the input threshold will not be symmetrical. This is typical of the MAX9025/MAX9026 where the internal reference is usually used as the threshold. If the asymmetry is unacceptable, it can be corrected by adding resistors to the circuit.

**Board Layout and Bypassing**

Power-supply bypass capacitors are not typically needed, but use 100nF bypass capacitors close to the device’s supply pins when supply impedance is high, supply leads are long, or excessive noise is expected on the supply lines. Minimize signal trace lengths to reduce stray capacitance. A ground plane and surface-mount components are recommended. If the REF pin is decoupled, use a new low-leakage capacitor.

**Zero-Crossing Detector**

Figure 4 shows a zero-crossing detector application. The MAX9027’s inverting input is connected to ground, and its noninverting input is connected to a 100mV<sub>P-P</sub> signal source. As the signal at the noninverting input crosses 0V, the comparator’s output changes state.

**Logic-Level Translator**

The *Typical Application Circuit* shows an application that converts 5V logic to 3V logic levels. The MAX9028 is powered by the +5V supply voltage, and the pullup resistor for the MAX9028’s open-drain output is connected to the +3V supply voltage. This configuration allows the full 5V logic swing without creating overvoltage on the 3V logic inputs. For 3V to 5V logic-level translations, simply connect the +3V supply voltage to  $V_{CC}$  and the +5V supply voltage to the pullup resistor.

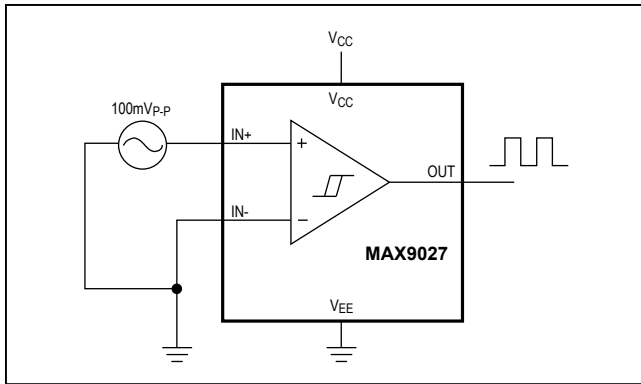
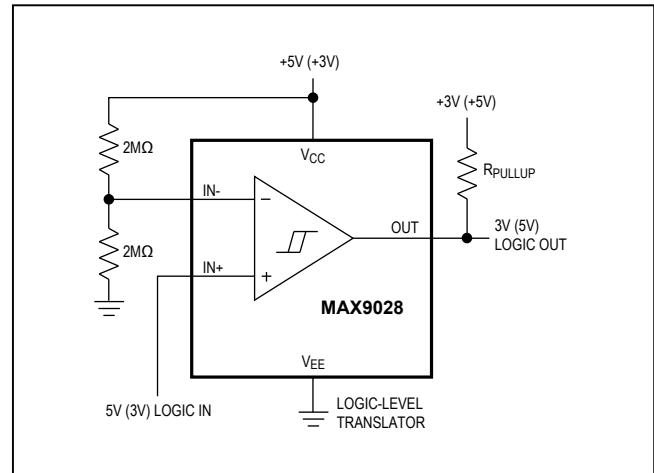

Figure 4. Zero-Crossing Detector

### UCSP Applications Information

For the latest application details on UCSP construction, dimensions, tape carrier information, printed circuit board techniques, bump-pad layout, and recommended reflow temperature profiles, as well as the latest information on reliability testing results, go to Application Note 1891: *Wafer-Level Packaging (WLP) and its Applications*.

### Typical Application Circuit



### Chip Information

PROCESS: BiCMOS

### Package Information

For the latest package outline information and land patterns (footprints), go to [www.maximintegrated.com/packages](http://www.maximintegrated.com/packages). Note that a “+”, “#”, or “-” in the package code indicates RoHS status only. Package drawings may show a different suffix character, but the drawing pertains to the package regardless of RoHS status.

PACKAGE TYPE	PACKAGE CODE	OUTLINE NO.	LAND PATTERN NO.
6 UCSP	B6+1	<a href="#">21-0097</a>	Refer to <a href="#">Application Note 1891</a>

## Revision History

REVISION NUMBER	REVISION DATE	DESCRIPTION	PAGES CHANGED
0	5/04	Initial release	—
1	6/11	Added information for lead-free versions	1

For pricing, delivery, and ordering information, please contact Maxim Direct at 1-888-629-4642, or visit Maxim Integrated's website at [www.maximintegrated.com](http://www.maximintegrated.com).

*Maxim Integrated cannot assume responsibility for use of any circuitry other than circuitry entirely embodied in a Maxim Integrated product. No circuit patent licenses are implied. Maxim Integrated reserves the right to change the circuitry and specifications without notice at any time. The parametric values (min and max limits) shown in the Electrical Characteristics table are guaranteed. Other parametric values quoted in this data sheet are provided for guidance.*