



Chipsmall Limited consists of a professional team with an average of over 10 year of expertise in the distribution of electronic components. Based in Hongkong, we have already established firm and mutual-benefit business relationships with customers from,Europe,America and south Asia,supplying obsolete and hard-to-find components to meet their specific needs.

With the principle of “Quality Parts,Customers Priority,Honest Operation,and Considerate Service”,our business mainly focus on the distribution of electronic components. Line cards we deal with include Microchip,ALPS,ROHM,Xilinx,Pulse,ON,Everlight and Freescale. Main products comprise IC,Modules,Potentiometer,IC Socket,Relay,Connector.Our parts cover such applications as commercial,industrial, and automotives areas.

We are looking forward to setting up business relationship with you and hope to provide you with the best service and solution. Let us make a better world for our industry!



Contact us

Tel: +86-755-8981 8866 Fax: +86-755-8427 6832

Email & Skype: info@chipsmall.com Web: www.chipsmall.com

Address: A1208, Overseas Decoration Building, #122 Zhenhua RD., Futian, Shenzhen, China





High-Speed, Low-Power, 3V/5V, Rail-to-Rail, Single-Supply Comparators

General Description

The MAX941/MAX942/MAX944 are single/dual/quad high-speed comparators optimized for systems powered from a 3V or 5V supply. These devices combine high speed, low power, and rail-to-rail inputs. Propagation delay is 80ns, while supply current is only 350 μ A per comparator.

The input common-mode range of the MAX941/MAX942/MAX944 extends beyond both power-supply rails. The outputs pull to within 0.4V of either supply rail without external pullup circuitry, making these devices ideal for interface with both CMOS and TTL logic. All input and output pins can tolerate a continuous short-circuit fault condition to either rail.

Internal hysteresis ensures clean output switching, even with slow-moving input signals. The MAX941 features latch enable and device shutdown.

The single MAX941 and dual MAX942 are offered in a tiny μ MAX[®] package. Both the single and dual MAX942 are available in 8-pin DIP and SO packages. The quad MAX944 comes in 14-pin DIP and narrow SO packages.

Applications

3V/5V Systems
 Battery-Powered Systems
 Threshold Detectors/Discriminators
 Line Receivers
 Zero-Crossing Detectors
 Sampling Circuits

Features

- ◆ Available in μ MAX Package for Automotive Applications
- ◆ Optimized for 3V and 5V Applications (Operation Down to 2.7V)
- ◆ Fast, 80ns Propagation Delay (5mV Overdrive)
- ◆ Rail-to-Rail Input Voltage Range
- ◆ Low 350 μ A Supply Current per Comparator
- ◆ Low, 1mV Offset Voltage
- ◆ Internal Hysteresis for Clean Switching
- ◆ Outputs Swing 200mV of Power Rails
- ◆ CMOS/TTL-Compatible Outputs
- ◆ Output Latch (MAX941 Only)
- ◆ Shutdown Function (MAX941 Only)

Ordering Information

| PART | TEMP RANGE | PIN-PACKAGE |
|-------------|-----------------|---------------|
| MAX941CPA | 0°C to +70°C | 8 Plastic DIP |
| MAX941CSA | 0°C to +70°C | 8 SO |
| MAX941EPA | -40°C to +85°C | 8 Plastic DIP |
| MAX941ESA | -40°C to +85°C | 8 SO |
| MAX941EUA-T | -40°C to +85°C | 8 μ MAX |
| MAX941AUA-T | -40°C to +125°C | 8 μ MAX |

Ordering Information continued at end of data sheet.

μ MAX is a registered trademark of Maxim Integrated Products, Inc.

Pin Configurations

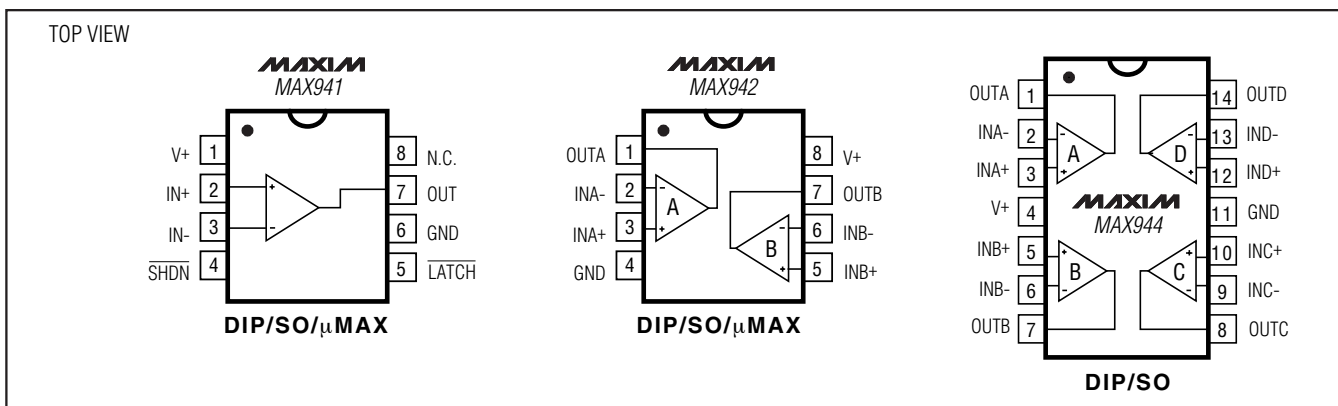

High-Speed, Low-Power, 3V/5V, Rail-to-Rail, Single-Supply Comparators

ABSOLUTE MAXIMUM RATINGS

Power-Supply Ranges

| | |
|--|----------------------|
| Supply Voltage V+ to GND | +6.5V |
| Differential Input Voltage | -0.3V to (V+ + 0.3V) |
| Common-Mode Input Voltage | -0.3V to (V+ + 0.3V) |
| LATCH Input (MAX941 only) | -0.3V to (V+ + 0.3V) |
| SHDN Control Input (MAX941 only) | -0.3V to (V+ + 0.3V) |
| Current Into Input Pins | ±20mA |

Continuous Power Dissipation (TA = +70°C)

| | |
|--|-------|
| 8-Pin Plastic DIP (derate 9.09mW/°C above +70°C) ... | 727mW |
| 8-Pin SO (derate 5.88mW/°C above +70°C) | 471mW |

| | |
|---|-------|
| 8-Pin μMAX (derate 4.1mW/°C above +70°C) | 330mW |
| 14-Pin Plastic DIP (derate 10.00mW/°C above +70°C) .. | 800mW |
| 14-Pin SO (derate 8.33mW/°C above +70°C) | 667mW |

Operating Temperature Ranges

| | |
|------------------|-----------------|
| MAX94_C_ _ | 0°C to +70°C |
| MAX94_E_ _ | -40°C to +85°C |
| MAX94_AUA | -40°C to +125°C |
| MAX942MSA | -55°C to +125°C |

| | |
|---|-----------------|
| Storage Temperature Range | -65°C to +150°C |
| Lead Temperature (soldering, 10s) | +300°C |

Stresses beyond those listed under "Absolute Maximum Ratings" may cause permanent damage to the device. These are stress ratings only, and functional operation of the device at these or any other conditions beyond those indicated in the operational sections of the specifications is not implied. Exposure to absolute maximum rating conditions for extended periods may affect device reliability.

ELECTRICAL CHARACTERISTICS

(V+ = 2.7V to 5.5V, TA = TMIN to TMAX, unless otherwise noted. Typical values are at TA = +25°C.) (Note 14)

| PARAMETER | SYMBOL | CONDITIONS | | MIN | TYP | MAX | UNITS |
|----------------------------------|-------------------|--|---|---|----------|----------|-------|
| Positive Supply Voltage | V+ | | | 2.7 | | 5.5 | V |
| Input Voltage Range | VCMR | (Note 1) | | -0.2 | | V+ + 0.2 | V |
| Input-Referred Trip Points | VTRIP | VCM = 0 or VCM = V+ (Note 2) | TA = +25°C | MAX94_C_ _, MAX94_EP_ _, MAX94_ES_ _, MAX942MSA | 1 | 3 | mV |
| | | | | MAX941_UA/MAX942_UA | 1 | 4 | |
| | | | TA = TMIN to TMAX | MAX94_C_ _, MAX94_EP_ _, MAX94_ES_ _, MAX942MSA | | 4 | mV |
| | | | | MAX941_UA/MAX942_UA | | 6 | |
| Input Offset Voltage | VOS | VCM = 0 or VCM = V+ (Note 3) | TA = +25°C | MAX94_C_ _, MAX94_EP_ _, MAX94_ES_ _, MAX942MSA | 1 | 2 | mV |
| | | | | MAX941_UA/MAX942_UA | 1 | 3 | |
| | | | TA = TMIN to TMAX | MAX94_C_ _, MAX94_EP_ _, MAX94_ES_ _, MAX942MSA | | 3 | mV |
| | | | | MAX941_UA/MAX942_UA | | 5.5 | |
| Input Bias Current | IB | VIN = VOS, VCM = 0 or VCM = V+ (Note 4) | MAX94_C | 150 | 300 | nA | |
| | | | MAX94_E/A, MAX942MSA | 150 | 400 | | |
| Input Offset Current | IOS | VIN = VOS, VCM = 0 or V+ | | | 10 | 150 | nA |
| Input Differential Clamp Voltage | VCLAMP | Force 100μA into IN+, IN- = GND, measure VIN+ - VIN-, Figure 3 | | | 2.2 | | V |
| Common-Mode Rejection Ratio | CMRR | (Note 5) | MAX94_C_ _, MAX94_EP_ _, MAX94_ES_ _, MAX942MSA | 80 | 300 | μV/V | |
| | | | MAX941_UA/MAX942_UA | 80 | 800 | | |
| Power-Supply Rejection Ratio | PSRR | 2.7V ≤ V+ ≤ 5.5V, VCM = 0V | MAX94_C_ _, MAX94_EP_ _, MAX94_ES_ _, MAX942MSA | 80 | 300 | μV/V | |
| | | | MAX941_UA/MAX942_UA | 80 | 350 | | |
| Output High Voltage | VOH | ISOURCE = 400μA | | V+ - 0.4 | V+ - 0.2 | V | |
| | | ISOURCE = 4mA | | V+ - 0.4 | V+ - 0.3 | | |
| Output Low Voltage | VOL | ISINK = 400μA | | 0.2 | 0.4 | V | |
| | | ISINK = 4mA | | 0.3 | 0.4 | | |
| Output Leakage Current | I _{LEAK} | (Note 6) | | | | 1 | μA |

High-Speed, Low-Power, 3V/5V, Rail-to-Rail, Single-Supply Comparators

MAX941/MAX942/MAX944

ELECTRICAL CHARACTERISTICS (continued)

(V₊ = 2.7V to 5.5V, T_A = T_{MIN} to T_{MAX}, unless otherwise noted. Typical values are at T_A = +25°C.) (Note 14)

| PARAMETER | SYMBOL | CONDITIONS | | MIN | TYP | MAX | UNITS |
|----------------------------------|--|--|----------------------|-----|-----------------------|-----------------------|-------|
| Supply Current per Comparator | I _{CC} | V ₊ = 3V | MAX941 | | 380 | 600 | μA |
| | | | MAX942/MAX944 | | 350 | 500 | |
| | | V ₊ = 5V | MAX941 | | 430 | 700 | |
| | | | MAX942/MAX944 | | 400 | 600 | |
| | | MAX941 only, shutdown mode (V ₊ = 3V) | | | 12 | 60 | |
| Power Dissipation per Comparator | PD | (Note 7) | MAX941 | | 1.0 | 4.2 | mW |
| | | | MAX942/MAX944 | | 1.0 | 3.6 | |
| Propagation Delay | t _{PD+} , t _{PD-} | (Note 8) | MAX94_C | | 80 | 150 | ns |
| | | | MAX94_E/A, MAX942MSA | | 80 | 200 | |
| Differential Propagation Delay | dt _{PD} | (Note 9) | | | 10 | | ns |
| Propagation Delay Skew | | (Note 10) | | | 10 | | ns |
| Logic Input Voltage High | V _{IH} | (Note 11) | | | $\frac{V_+}{2} + 0.4$ | $\frac{V_+}{2}$ | V |
| Logic Input Voltage Low | V _{IL} | (Note 11) | | | $\frac{V_+}{2}$ | $\frac{V_+}{2} - 0.4$ | V |
| Logic Input Current | I _{IL} , I _{IH} | V _{LOGIC} = 0 or V ₊ (Note 11) | | | 2 | 10 | μA |
| Data-to-Latch Setup Time | t _S | (Note 12) | | | 20 | | ns |
| Latch-to-Data Hold Time | t _H | (Note 12) | | | 30 | | ns |
| Latch Pulse Width | t _{LPW} | MAX941 only | | | 50 | | ns |
| Latch Propagation Delay | t _{LPD} | MAX941 only | | | 70 | | ns |
| Shutdown Time | | (Note 13) | | | 3 | | μs |
| Shutdown Disable Time | | (Note 13) | | | 10 | | μs |

- Note 1:** Inferred from the CMRR test. Note also that either or both inputs can be driven to the absolute maximum limit (0.3V beyond either supply rail) without damage or false output inversion.
- Note 2:** The input-referred trip points are the extremities of the differential input voltage required to make the comparator output change state. The difference between the upper and lower trip points is equal to the width of the input-referred hysteresis zone (see Figure 1).
- Note 3:** V_{OS} is defined as the center of the input-referred hysteresis zone (see Figure 1).
- Note 4:** The polarity of I_B reverses direction as V_{CM} approaches either supply rail. See *Typical Operating Characteristics* for more detail.
- Note 5:** Specified over the full common-mode range (V_{CMR}).
- Note 6:** Applies to the MAX941 only when in shutdown mode. Specification is for current flowing into or out of the output pin for V_{OUT} driven to any voltage from V₊ to GND.
- Note 7:** Typical power dissipation specified with V₊ = 3V; maximum with V₊ = 5.5V.
- Note 8:** Parameter is guaranteed by design and specified with V_{OD} = 5mV and C_{LOAD} = 15pF in parallel with 400μA of sink or source current. V_{OS} is added to the overdrive voltage for low values of overdrive (see Figure 2).
- Note 9:** Specified between any two channels in the MAX942/MAX944.
- Note 10:** Specified as the difference between t_{PD+} and t_{PD-} for any one comparator.
- Note 11:** Applies to the MAX941 only for both $\overline{\text{SHDN}}$ and $\overline{\text{LATCH}}$ pins.
- Note 12:** Applies to the MAX941 only. Comparator is active with $\overline{\text{LATCH}}$ pin driven high and is latched with $\overline{\text{LATCH}}$ pin driven low (see Figure 2).
- Note 13:** Applicable to the MAX941 only. Comparator is active with $\overline{\text{SHDN}}$ pin driven high and is in shutdown with $\overline{\text{SHDN}}$ pin driven low. Shutdown disable time is the delay when $\overline{\text{SHDN}}$ is driven high to the time the output is valid.
- Note 14:** The MAX941_UA and MAX942_UA are 100% production tested at T_A = +25°C. Specifications over temperature are guaranteed by design.

High-Speed, Low-Power, 3V/5V, Rail-to-Rail, Single-Supply Comparators

Typical Operating Characteristics

($V_+ = 3.0V$, $T_A = +25^\circ C$, unless otherwise noted.)

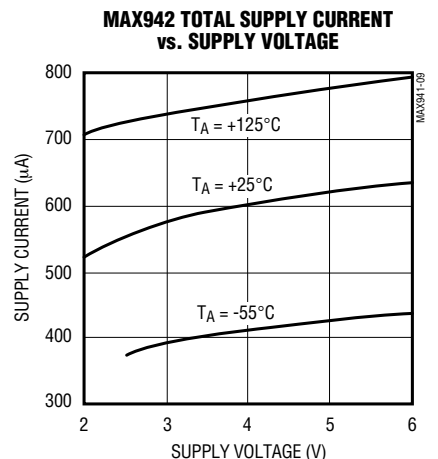
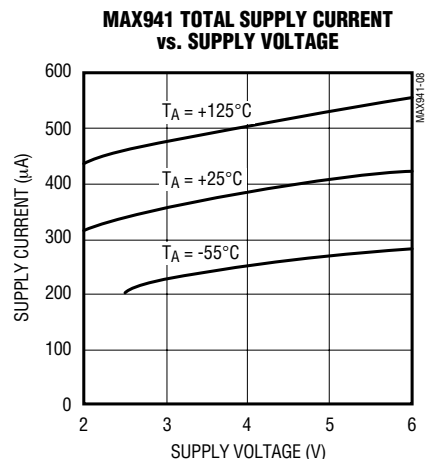
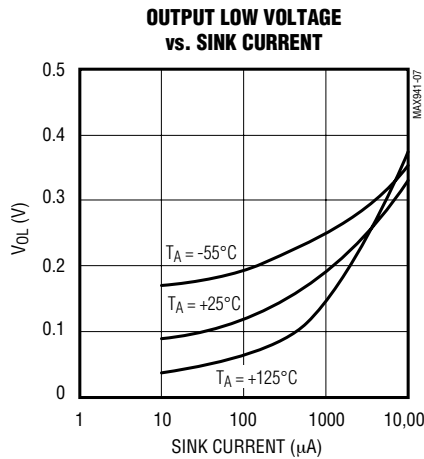
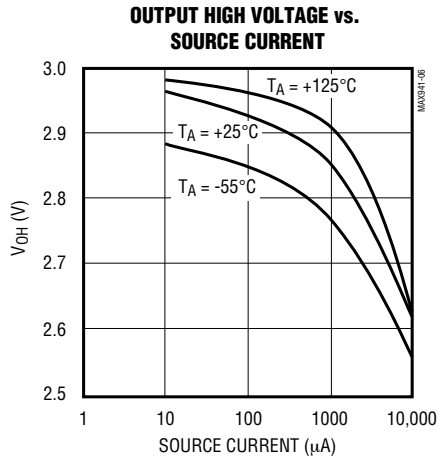
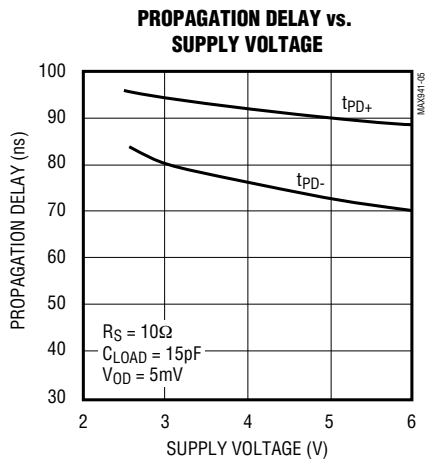
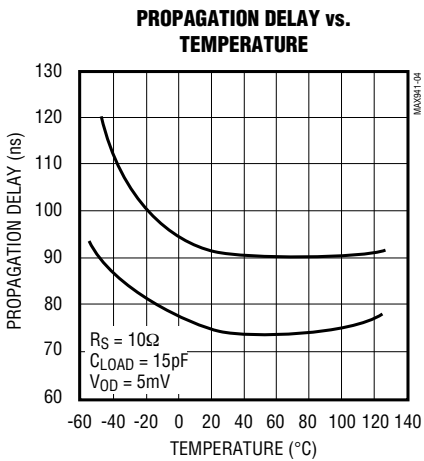
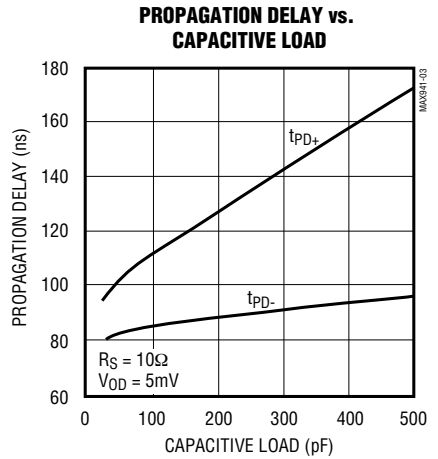
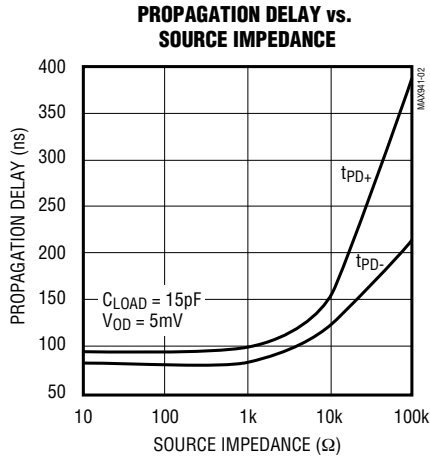
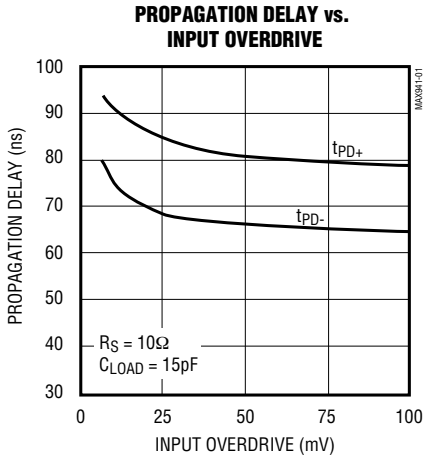

High-Speed, Low-Power, 3V/5V, Rail-to-Rail, Single-Supply Comparators

Typical Operating Characteristics (continued)

($V_+ = 3.0V$, $T_A = +25^\circ C$, unless otherwise noted.)

MAX941/MAX942/MAX944

MAX944 TOTAL SUPPLY CURRENT vs. SUPPLY VOLTAGE

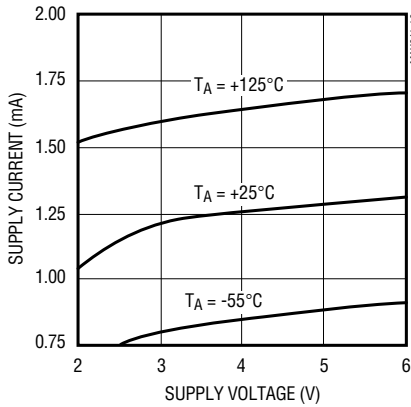

INPUT VOLTAGE RANGE vs. TEMPERATURE

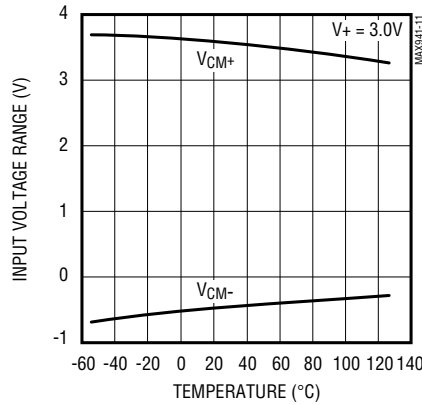

SHORT-CIRCUIT OUTPUT CURRENT vs. TEMPERATURE

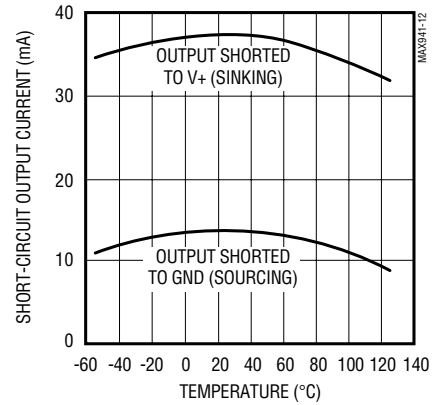

VOLTAGE TRIP POINTS/INPUT OFFSET VOLTAGE vs. TEMPERATURE

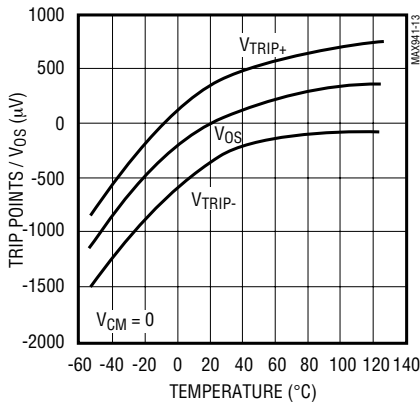

INPUT BIAS CURRENT/INPUT OFFSET CURRENT vs. TEMPERATURE

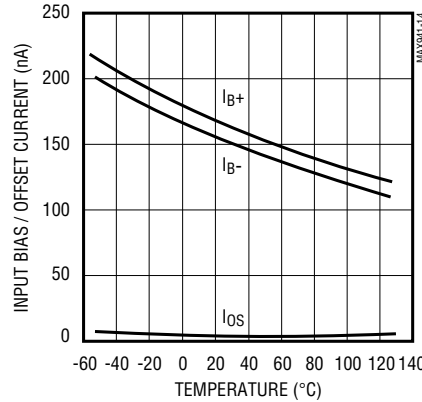

INPUT BIAS CURRENT (I_{B+} , I_{B-}) vs. COMMON-MODE VOLTAGE

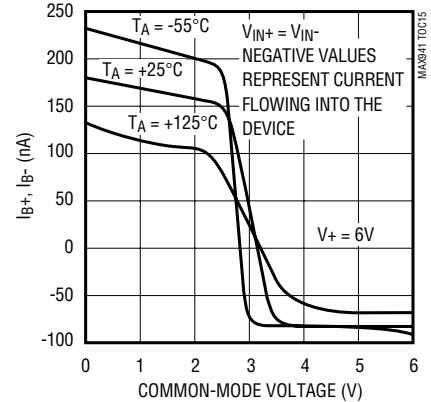

MAX941 SHUTDOWN SUPPLY CURRENT vs. TEMPERATURE

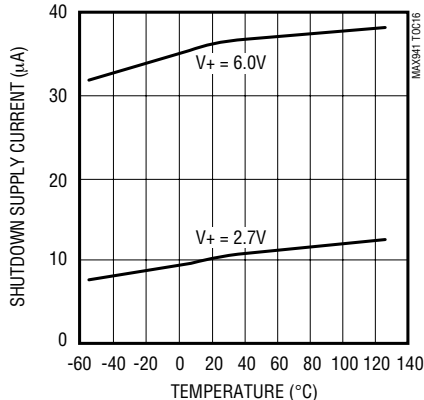

10MHz RESPONSE

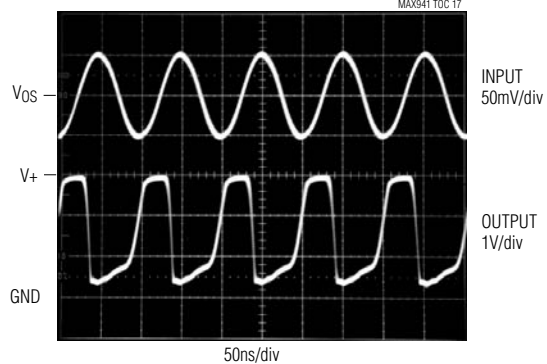

High-Speed, Low-Power, 3V/5V, Rail-to-Rail, Single-Supply Comparators

Typical Operating Characteristics (continued)

(V+ = 3.0V, T_A = +25°C, unless otherwise noted.)

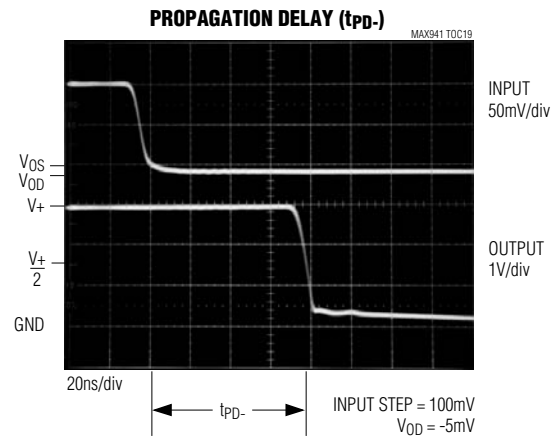
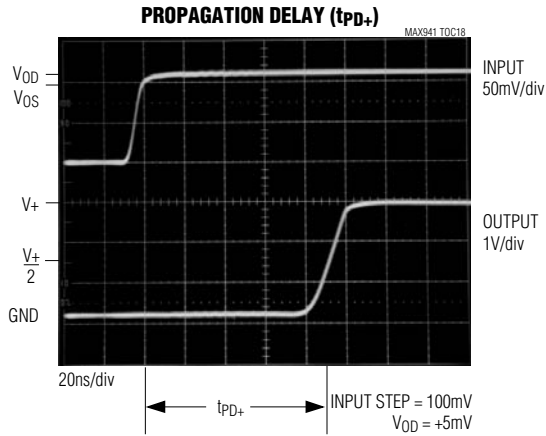

Pin Description

| PIN | | | NAME | FUNCTION |
|--------|--------|--------|---------------------------|---|
| MAX941 | MAX942 | MAX944 | | |
| — | 1 | 1 | OUTA | Comparator A Output |
| — | 2 | 2 | INA- | Comparator A Inverting Input |
| — | 3 | 3 | INA+ | Comparator A Noninverting Input |
| 1 | 8 | 4 | V+ | Positive Supply (V+ to GND must be ≤ 6.5V) |
| — | 5 | 5 | INB+ | Comparator B Noninverting Input |
| — | 6 | 6 | INB- | Comparator B Inverting Input |
| — | 7 | 7 | OUTB | Comparator B Output |
| — | — | 8 | OUTC | Comparator C Output |
| — | — | 9 | INC- | Comparator C Inverting Input |
| — | — | 10 | INC+ | Comparator C Noninverting Input |
| 6 | 4 | 11 | GND | Ground |
| — | — | 12 | IND+ | Comparator D Noninverting Input |
| — | — | 13 | IND- | Comparator D Inverting Input |
| — | — | 14 | OUTD | Comparator D Output |
| 2 | — | — | IN+ | Noninverting Input |
| 3 | — | — | IN- | Inverting Input |
| 4 | — | — | $\overline{\text{SHDN}}$ | Shutdown: MAX941 is active when $\overline{\text{SHDN}}$ is driven high; MAX941 is in shutdown when SHDN is driven low. |
| 5 | — | — | $\overline{\text{LATCH}}$ | The output is latched when $\overline{\text{LATCH}}$ is low. The latch is transparent when $\overline{\text{LATCH}}$ is high. |
| 7 | — | — | OUT | Comparator Output |
| 8 | — | — | N.C. | No Connection. Not internally connected. |

High-Speed, Low-Power, 3V/5V, Rail-to-Rail, Single-Supply Comparators

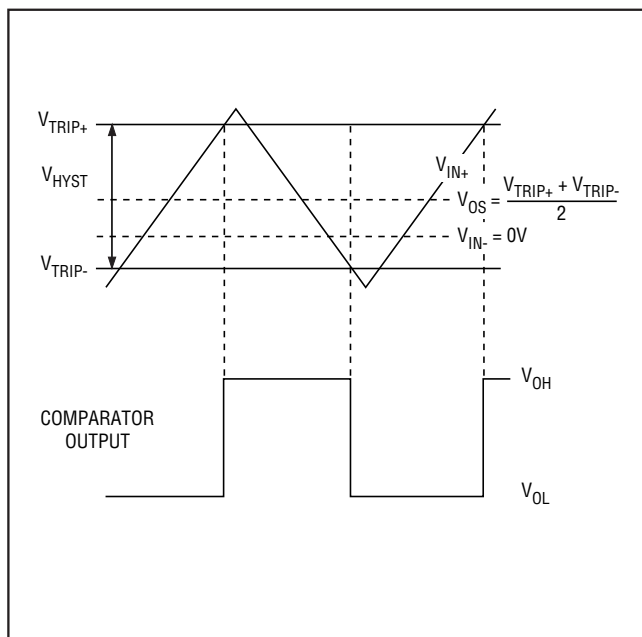

Figure 1. Input and Output Waveform, Noninverting Input Varied

Detailed Description

The MAX941/MAX942/MAX944 single-supply comparators feature internal hysteresis, high speed, and low power. Their outputs are guaranteed to pull within 0.4V of either supply rail without external pullup or pulldown circuitry. Rail-to-rail input voltage range and low-voltage single-supply operation make these devices ideal for portable equipment. The MAX941/MAX942/MAX944 interface directly to CMOS and TTL logic.

Timing

Most high-speed comparators oscillate in the linear region because of noise or undesired parasitic feedback. This tends to occur when the voltage on one input is at or equal to the voltage on the other input. To counter the parasitic effects and noise, the MAX941/MAX942/MAX944 have internal hysteresis.

The hysteresis in a comparator creates two trip points: one for the rising input voltage and one for the falling input voltage (Figure 1). The difference between the trip points is the hysteresis. When the comparator's input voltages are equal, the hysteresis effectively causes one comparator input voltage to move quickly past the other, thus taking the input out of the region where

oscillation occurs. Standard comparators require hysteresis to be added with external resistors. The MAX941/MAX942/MAX944's fixed internal hysteresis eliminates these resistors and the equations needed to determine appropriate values.

Figure 1 illustrates the case where $IN-$ is fixed and $IN+$ is varied. If the inputs were reversed, the figure would look the same, except the output would be inverted.

The MAX941 includes an internal latch that allows storage of comparison results. The \overline{LATCH} pin has a high input impedance. If \overline{LATCH} is high, the latch is transparent (i.e., the comparator operates as though the latch is not present). The comparator's output state is stored when \overline{LATCH} is pulled low. All timing constraints must be met when using the latch function (Figure 2).

Shutdown Mode (MAX941 Only)

The MAX941 shuts down when \overline{SHDN} is low. When shut down, the supply current drops to less than 60 μ A, and the three-state output becomes high impedance. The \overline{SHDN} pin has a high input impedance. Connect \overline{SHDN} to $V+$ for normal operation. Exit shutdown with \overline{LATCH} high; otherwise, the output will be indeterminate.

Input Stage Circuitry

The MAX941/MAX942/MAX944 include internal protection circuitry that prevents damage to the precision input stage from large differential input voltages. This protection circuitry consists of two back-to-back diodes between $IN+$ and $IN-$ as well as two 4.1k Ω resistors (Figure 3). The diodes limit the differential voltage applied to the internal circuitry of the comparators to be no more than $2V_F$, where V_F is the forward voltage drop of the diode (about 0.7V at +25 $^{\circ}$ C).

For a large differential input voltage (exceeding $2V_F$), this protection circuitry increases the input bias current at $IN+$ (source) and $IN-$ (sink).

$$\text{Input Current} = \frac{(IN+ - IN-) - 2V_F}{2 \times 4.1k\Omega}$$

Input current with large differential input voltages should not be confused with input bias current (I_B). As long as the differential input voltage is less than $2V_F$, this input current is equal to I_B . The protection circuitry also allows for the input common-mode range of the MAX941/MAX942/MAX944 to extend beyond both power-supply rails. The output is in the correct logic state if one or both inputs are within the common-mode range.

High-Speed, Low-Power, 3V/5V, Rail-to-Rail, Single-Supply Comparators

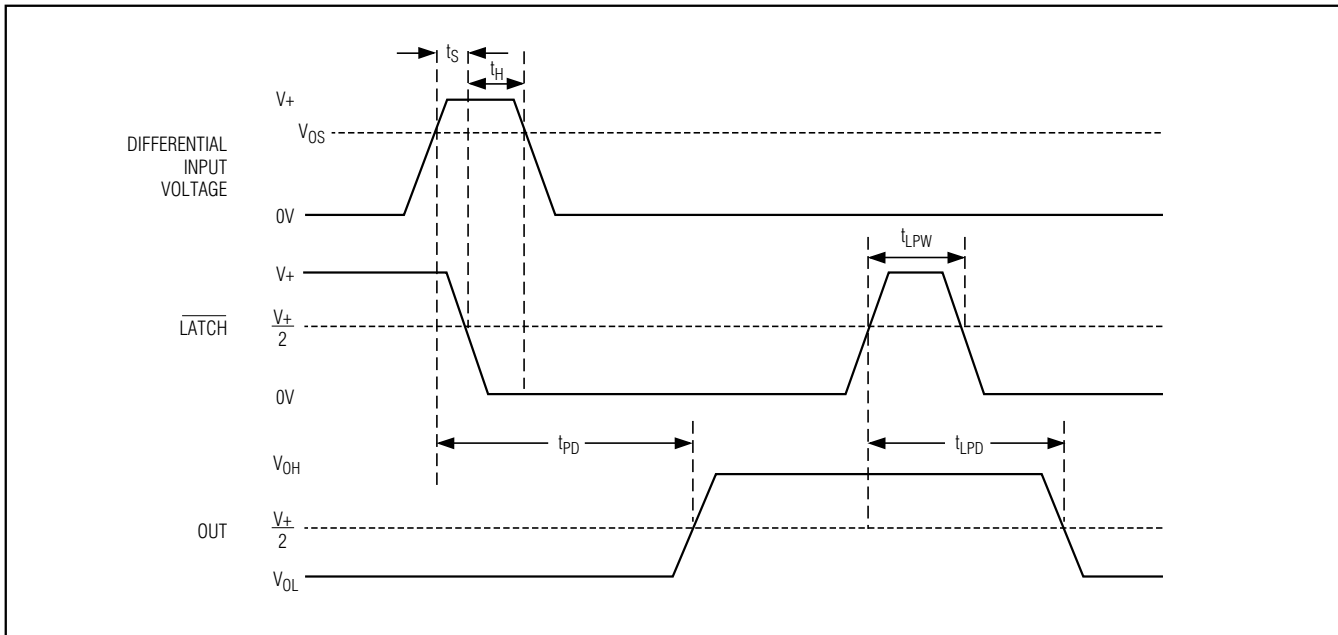

Figure 2. MAX941 Timing Diagram with Latch Operator

Output Stage Circuitry

The MAX941/MAX942/MAX944 contain a current-driven output stage as shown in Figure 4. During an output transition, I_{SOURCE} or I_{SINK} is pushed or pulled to the output pin. The output source or sink current is high during the transition, creating a rapid slew rate. Once the output voltage reaches V_{OH} or V_{OL}, the source or sink current decreases to a small value, capable of maintaining the V_{OH} or V_{OL} static condition. This significant decrease in current conserves power after an output transition has occurred.

One consequence of a current-driven output stage is a linear dependence between the slew rate and the load capacitance. A heavy capacitive load will slow down a voltage output transition. This can be useful in noise-sensitive applications where fast edges may cause interference.

Applications Information

Circuit Layout and Bypassing

The high gain bandwidth of the MAX941/MAX942/MAX944 requires design precautions to realize the comparators' full high-speed capability. The recommended precautions are:

- 1) Use a printed circuit board with a good, unbroken, low-inductance ground plane.
- 2) Place a decoupling capacitor (a 0.1μF ceramic capacitor is a good choice) as close to V₊ as possible.
- 3) Pay close attention to the decoupling capacitor's bandwidth, keeping leads short.
- 4) On the inputs and outputs, keep lead lengths short to avoid unwanted parasitic feedback around the comparators.
- 5) Solder the device directly to the printed circuit board instead of using a socket.

High-Speed, Low-Power, 3V/5V, Rail-to-Rail, Single-Supply Comparators

MAX941/MAX942/MAX944

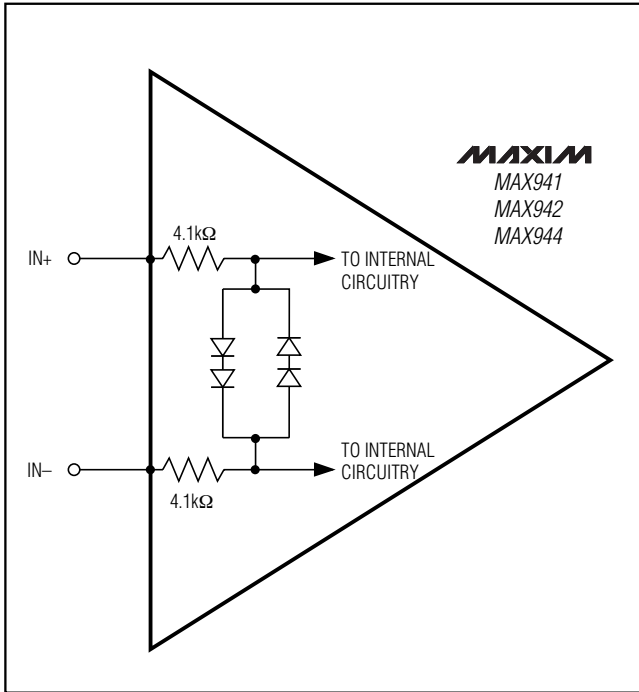

Figure 3. Input Stage Circuitry

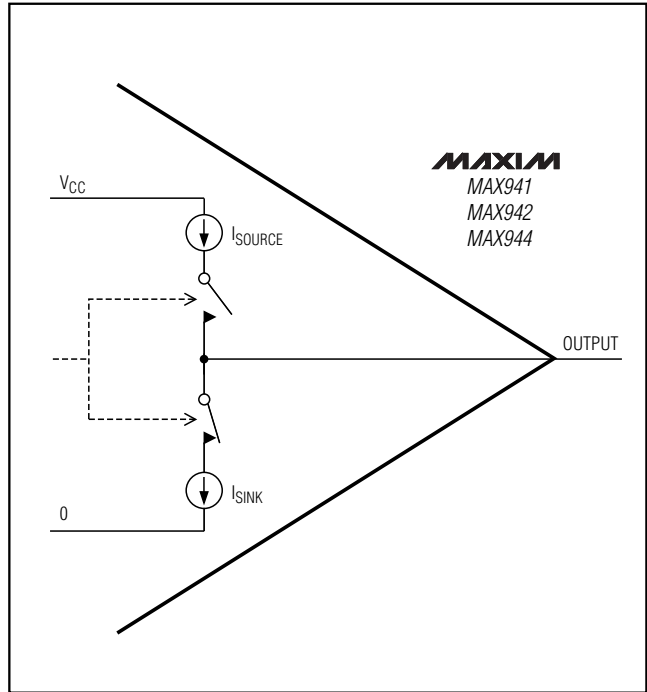

Figure 4. Output Stage Circuitry

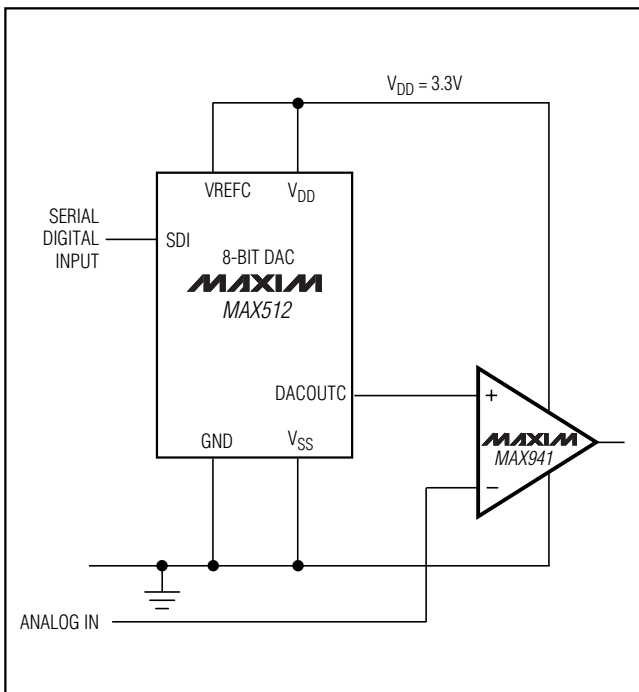

Figure 5. 3.3V Digitally Controlled Threshold Detector

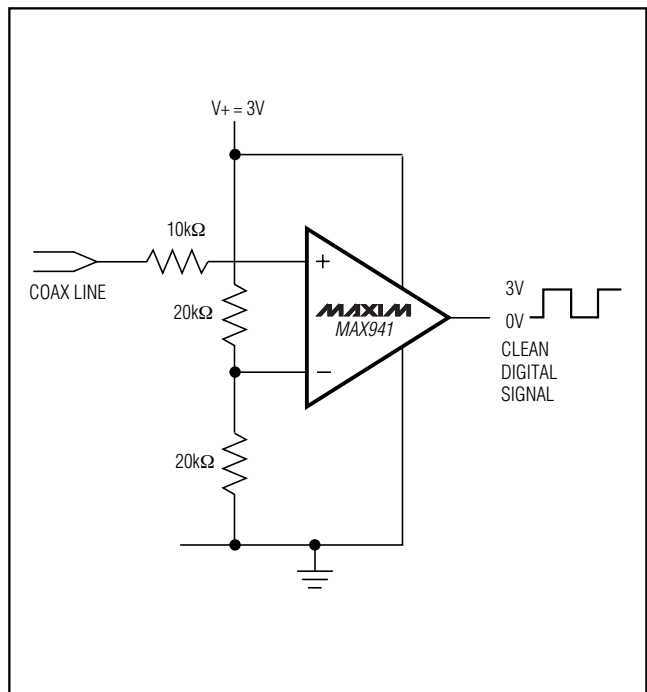

Figure 6. Line Transceiver Application

High-Speed, Low-Power, 3V/5V, Rail-to-Rail, Single-Supply Comparators

Ordering Information (continued)

| PART | TEMP RANGE | PIN-PACKAGE |
|----------------------|-----------------|----------------|
| MAX942 MSA/PR | -55°C to +125°C | 8 SO |
| MAX942CPA | 0°C to +70°C | 8 Plastic DIP |
| MAX942CSA | 0°C to +70°C | 8 SO |
| MAX942EPA | -40°C to +85°C | 8 Plastic DIP |
| MAX942ESA | -40°C to +85°C | 8 SO |
| MAX942EUA-T | -40°C to +85°C | 8 μ MAX |
| MAX942AUA-T | -40°C to +125°C | 8 μ MAX |
| MAX944 CPD | 0°C to +70°C | 14 Plastic DIP |
| MAX944CSD | 0°C to +70°C | 14 SO |
| MAX944EPD | -40°C to +85°C | 14 Plastic DIP |
| MAX944ESD | -40°C to +85°C | 14 SO |

Chip Information

PROCESS: BIPOLAR

High-Speed, Low-Power, 3V/5V, Rail-to-Rail, Single-Supply Comparators

Package Information

(For the latest package outline information and land patterns, go to www.maxim-ic.com/packages.)

| PACKAGE TYPE | PACKAGE CODE | DOCUMENT NO. |
|----------------|--------------|-------------------------|
| 8 μ MAX | U8-1 | 21-0036 |
| 8 Plastic DIP | P8-1 | 21-0043 |
| 8 SO | S8-2 | 21-0041 |
| 14 Plastic DIP | P14-3 | 21-0043 |
| 14 SO | S14-1 | 21-0041 |

MAX941/MAX942/MAX944

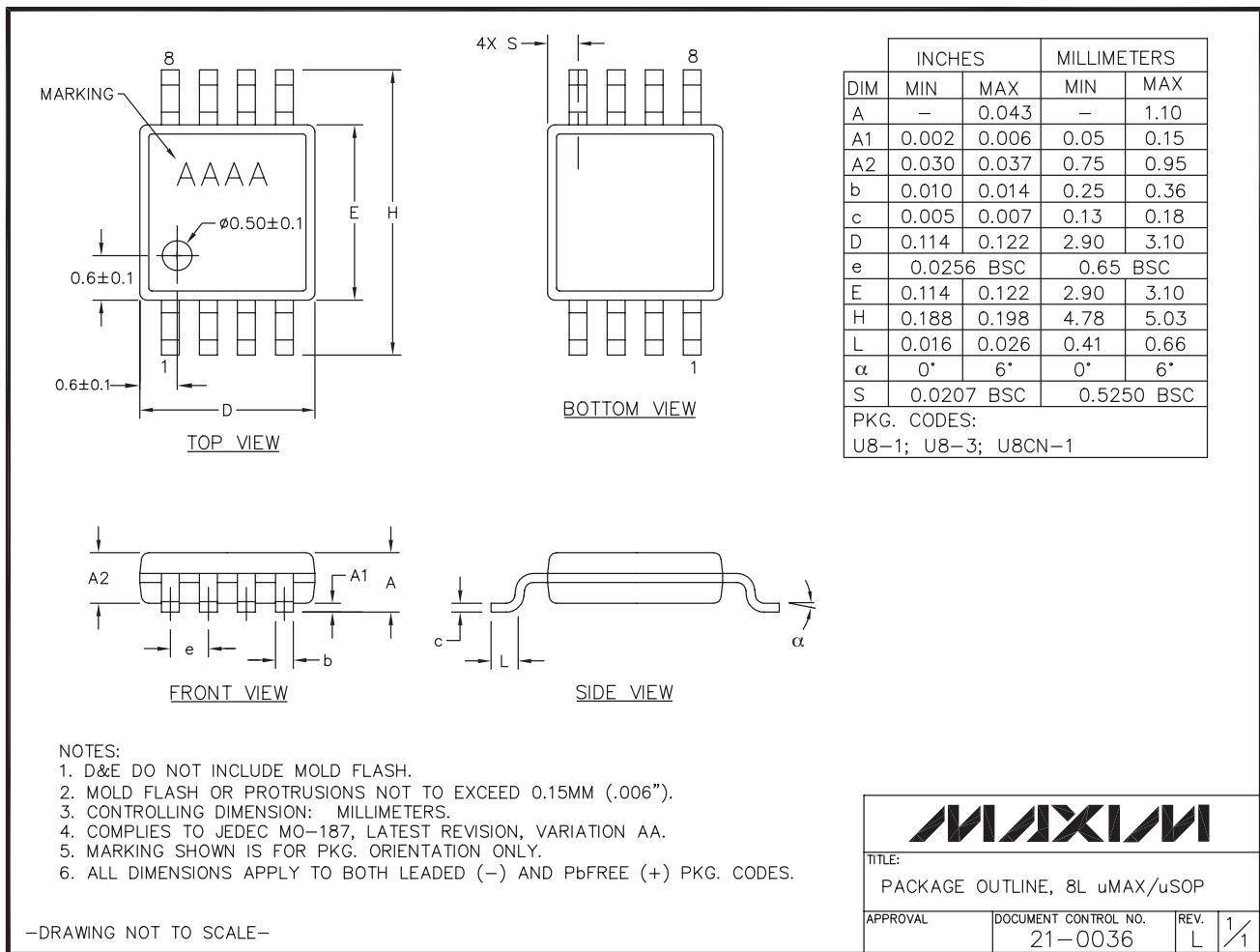

High-Speed, Low-Power, 3V/5V, Rail-to-Rail, Single-Supply Comparators

Package Information (continued)

(For the latest package outline information and land patterns, go to www.maxim-ic.com/packages.)

PDIPN EFS

| | INCHES | | MILLIMETERS | |
|----|------------|-------|-------------|-------|
| | MIN | MAX | MIN | MAX |
| A | --- | 0.180 | --- | 4.572 |
| A1 | 0.015 | --- | 0.38 | --- |
| A2 | 0.125 | 0.175 | 3.18 | 4.45 |
| A3 | 0.055 | 0.080 | 1.40 | 2.03 |
| B | 0.015 | 0.022 | 0.381 | 0.56 |
| B1 | 0.045 | 0.065 | 1.14 | 1.65 |
| C | 0.008 | 0.014 | 0.2 | 0.355 |
| D1 | 0.005 | 0.080 | 0.13 | 2.03 |
| E | 0.300 | 0.325 | 7.62 | 8.26 |
| E1 | 0.240 | 0.310 | 6.10 | 7.87 |
| e | 0.100 BSC. | | 2.54 BSC. | |
| eA | 0.300 BSC. | | 7.62 BSC. | |
| eB | 0.400 BSC. | | 10.16 BSC. | |
| L | 0.115 | 0.150 | 2.921 | 3.81 |

| | INCHES | | MILLIMETERS | | N | MS001 |
|---|--------|-------|-------------|-------|----|-------|
| | MIN | MAX | MIN | MAX | | |
| D | 0.348 | 0.390 | 8.84 | 9.91 | 8 | AB |
| D | 0.735 | 0.765 | 18.67 | 19.43 | 14 | AC |
| D | 0.745 | 0.765 | 18.92 | 19.43 | 16 | AA |
| D | 0.885 | 0.915 | 22.48 | 23.24 | 18 | AD |
| D | 1.015 | 1.045 | 25.78 | 26.54 | 20 | AE |
| D | 1.14 | 1.265 | 28.96 | 32.13 | 24 | AF |
| D | 1.360 | 1.380 | 34.54 | 35.05 | 28 | *5 |

NOTES:
 1. D&E DO NOT INCLUDE MOLD FLASH
 2. MOLD FLASH OR PROTRUSIONS NOT TO EXCEED .15mm (.006")
 3. CONTROLLING DIMENSION: MILLIMETER
 4. MEETS JEDEC MS001-XX AS SHOWN IN ABOVE TABLE
 5. SIMILIAR TO JEDEC MO-058AB
 6. N = NUMBER OF PINS

MAXIM
 1201 SINGAPORE DR. SUMMIT CA 94066 FAX (415) 737 7594
 PROPRIETARY INFORMATION

PACKAGE FAMILY OUTLINE: PDIP .300" $\frac{1}{1}$ 21-0043 D
 TITLE DOCUMENT CONTROL NUMBER REV

High-Speed, Low-Power, 3V/5V, Rail-to-Rail, Single-Supply Comparators

Package Information (continued)

(For the latest package outline information and land patterns, go to www.maxim-ic.com/packages.)

MAX941/MAX942/MAX944

SOICN, EPS

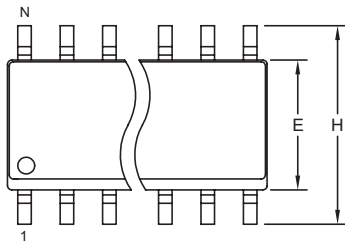

TOP VIEW

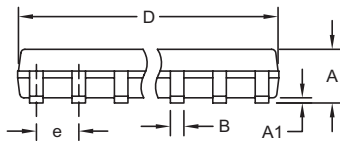

FRONT VIEW

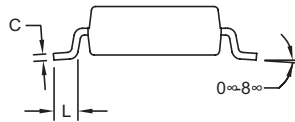

SIDE VIEW

| DIM | INCHES | | MILLIMETERS | |
|-----|-----------|-------|-------------|------|
| | MIN | MAX | MIN | MAX |
| A | 0.053 | 0.069 | 1.35 | 1.75 |
| A1 | 0.004 | 0.010 | 0.10 | 0.25 |
| B | 0.014 | 0.019 | 0.35 | 0.49 |
| C | 0.007 | 0.010 | 0.19 | 0.25 |
| e | 0.050 BSC | | 1.27 BSC | |
| E | 0.150 | 0.157 | 3.80 | 4.00 |
| H | 0.228 | 0.244 | 5.80 | 6.20 |
| L | 0.016 | 0.050 | 0.40 | 1.27 |

VARIATIONS:

| DIM | INCHES | | MILLIMETERS | | N | MS012 |
|-----|--------|-------|-------------|-------|----|-------|
| | MIN | MAX | MIN | MAX | | |
| D | 0.189 | 0.197 | 4.80 | 5.00 | 8 | AA |
| D | 0.337 | 0.344 | 8.55 | 8.75 | 14 | AB |
| D | 0.386 | 0.394 | 9.80 | 10.00 | 16 | AC |

NOTES:

1. D&E DO NOT INCLUDE MOLD FLASH.
2. MOLD FLASH OR PROTRUSIONS NOT TO EXCEED 0.15mm (.006").
3. LEADS TO BE COPLANAR WITHIN 0.10mm (.004").
4. CONTROLLING DIMENSION: MILLIMETERS.
5. MEETS JEDEC MS012.
6. N = NUMBER OF PINS.

| | |
|--|--|
| | |
| <small>PROPRIETARY INFORMATION</small> | |
| <small>TITLE:</small> PACKAGE OUTLINE, .150" SOIC | |
| <small>APPROVAL</small> | <small>DOCUMENT CONTROL NO.</small> 21-0041 |
| <small>REV.</small> B | <small>1/1</small> |

High-Speed, Low-Power, 3V/5V, Rail-to-Rail, Single-Supply Comparators

Revision History

| REVISION NUMBER | REVISION DATE | DESCRIPTION | PAGES CHANGED |
|-----------------|---------------|---|---------------|
| 8 | 12/08 | Added SO package diagram and removed transistor count | 10 |
| 9 | 3/09 | Corrected <i>Ordering Information</i> for MAX944ESD | 10 |

Maxim cannot assume responsibility for use of any circuitry other than circuitry entirely embodied in a Maxim product. No circuit patent licenses are implied. Maxim reserves the right to change the circuitry and specifications without notice at any time.

14 _____ **Maxim Integrated Products, 120 San Gabriel Drive, Sunnyvale, CA 94086 (408) 737-7600**