



Chipsmall Limited consists of a professional team with an average of over 10 year of expertise in the distribution of electronic components. Based in Hongkong, we have already established firm and mutual-benefit business relationships with customers from,Europe,America and south Asia,supplying obsolete and hard-to-find components to meet their specific needs.

With the principle of “Quality Parts,Customers Priority,Honest Operation,and Considerate Service”,our business mainly focus on the distribution of electronic components. Line cards we deal with include Microchip,ALPS,ROHM,Xilinx,Pulse,ON,Everlight and Freescale. Main products comprise IC,Modules,Potentiometer,IC Socket,Relay,Connector.Our parts cover such applications as commercial,industrial, and automotives areas.

We are looking forward to setting up business relationship with you and hope to provide you with the best service and solution. Let us make a better world for our industry!



## Contact us

Tel: +86-755-8981 8866 Fax: +86-755-8427 6832

Email & Skype: info@chipsmall.com Web: www.chipsmall.com

Address: A1208, Overseas Decoration Building, #122 Zhenhua RD., Futian, Shenzhen, China



EVALUATION KIT  
AVAILABLE

# 1.8V, Ultra-Low Power, DirectDrive Video Filter Amplifiers

## General Description

Operating from a 1.8V single power supply, the MAX9509/MAX9510 amplify standard-definition video signals and only consume 5.8mW quiescent power and 11.7mW average power. The MAX9509/MAX9510 leverage Maxim's DirectDrive™ technology to generate a clean, internal negative supply. Combining the internal negative power supply with the external positive 1.8V supply, the MAX9509/MAX9510 are able to drive a 2V<sub>P-P</sub> video signal into a 150Ω load.

Besides increasing the output voltage range, Maxim's DirectDrive technology eliminates large output-coupling capacitors and sets the output video black level near ground. DirectDrive requires an integrated charge pump and an internal linear regulator to create a clean negative power supply so that the amplifier can pull the sync below ground. The charge pump injects little noise into the video output, making the picture visibly flawless.

The MAX9509/MAX9510 are designed to operate from the 1.8V digital power supply. The high power-supply rejection ratio (49dB at 100kHz) allows the MAX9509/MAX9510 to reject the noise from the digital power supply.

The MAX9509 features an internal reconstruction filter that smoothes the steps and reduces the spikes on the video signal from the video digital-to-analog converter (DAC). The reconstruction filter typically has ±1dB passband flatness of 8.1MHz and 46dB attenuation at 27MHz. The large-signal, ±1dB passband flatness of the MAX9510 video amplifier is typically 8.4MHz, and the large signal -3dB frequency is typically 11.4MHz.

The input of the MAX9509/MAX9510 can be directly connected to the output of a video DAC. The MAX9509/MAX9510 also feature a transparent input sync-tip clamp, allowing AC-coupling of input signals with different DC biases. The MAX9509/MAX9510 have an internal fixed gain of 8. The input full-scale video signal is nominally 0.25V<sub>P-P</sub>, and the output full-scale video signal is nominally 2V<sub>P-P</sub>. The devices operate from a 1.8V or 2.5V single supply and feature a 10nA low-power shutdown mode. The MAX9509 is offered in an 8-pin TDFN package and the MAX9510 is offered in an 8-pin μMAX® package.

## Features

- ◆ 5.8mW Quiescent Power Consumption
- ◆ 11.7mW Average Power Consumption
- ◆ 1.8V or 2.5V Single-Supply Operation
- ◆ Reconstruction Filter with 8.1MHz Passband and 46dB Attenuation at 27MHz (MAX9509)
- ◆ DirectDrive Sets Video Output Black Level near Ground
- ◆ DC-Coupled Input/Output
- ◆ Transparent Input Sync-Tip Clamp
- ◆ Internal Fixed Gain of 8
- ◆ 10nA Shutdown Supply Current

## Applications

|                              |                         |
|------------------------------|-------------------------|
| Digital Still Cameras (DSC)  | Mobile Phones           |
| Digital Video Cameras (DVC)  | Security/CCTV Cameras   |
| Portable Media Players (PMP) | Automotive Applications |

## Block Diagram

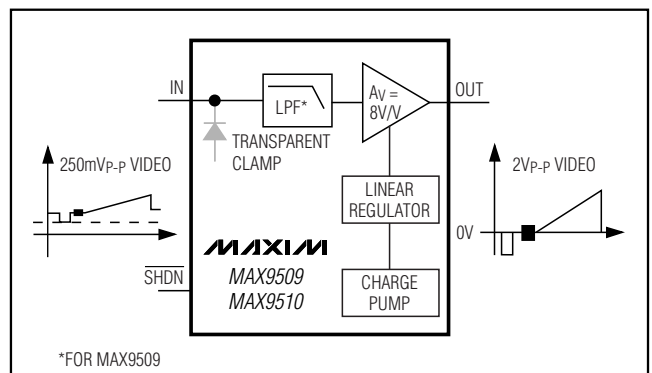

μMAX is a registered trademark of Maxim Integrated Products, Inc.

## Ordering Information

| PART         | RECONSTRUCTION FILTER | PIN-PACKAGE | TOP MARK | PACKAGE CODE |
|--------------|-----------------------|-------------|----------|--------------|
| MAX9509ATA+T | Yes                   | 8 TDFN-EP*  | AAZ      | T822-1       |
| MAX9510AUA+T | No                    | 8 μMAX-8    | —        | U8-1         |

**Note:** All devices are specified over the -40°C to +125°C operating temperature range.

+ Denotes lead-free package.

\*EP = Exposed pad.

Pin Configurations appear at end of data sheet.



Maxim Integrated Products 1

For pricing, delivery, and ordering information, please contact Maxim/Dallas Direct! at 1-888-629-4642, or visit Maxim's website at [www.maxim-ic.com](http://www.maxim-ic.com).

# 1.8V, Ultra-Low Power, DirectDrive Video Filter Amplifiers

## ABSOLUTE MAXIMUM RATINGS

(Voltages with respect to GND.)

|  |  |
|--|--|
| V <sub>DD</sub> .....  | -0.3V to +3V   |
| IN .....   | -0.3V to (V <sub>DD</sub> + 0.3V)                                    |
| OUT .....  | (The greater of V <sub>SS</sub> and -1V) to (V <sub>DD</sub> + 0.3V) |
| SHDN .....   | -0.3V to +4V   |
| C1P .....  | -0.3V to (V <sub>DD</sub> + 0.3V)                                    |
| C1N .....  | (V <sub>SS</sub> - 0.3V) to +0.3V                                    |
| V <sub>SS</sub> .....  | -3V to +0.3V   |
| Duration of OUT Short Circuit to V <sub>DD</sub> ,<br>GND, and V <sub>SS</sub> ..... | Continuous   |

Continuous Current

|   |                 |
|---|-----------------|
| IN, SHDN .....  | ±20mA           |
| Continuous Power Dissipation (T <sub>A</sub> = +70°C) |                 |
| 8-Pin TDFN (derate 11.9mW/°C above +70°C) .....       | 953.5mW         |
| 8-Pin μMAX (derate 4.5mW/°C above +70°C) .....        | 362mW           |
| Operating Temperature Range .....                     | -40°C to +125°C |
| Junction Temperature .....                            | +150°C          |
| Storage Temperature Range .....                       | -65°C to +150°C |
| Lead Temperature (soldering, 10s) .....               | +300°C          |

Stresses beyond those listed under "Absolute Maximum Ratings" may cause permanent damage to the device. These are stress ratings only, and functional operation of the device at these or any other conditions beyond those indicated in the operational sections of the specifications is not implied. Exposure to absolute maximum rating conditions for extended periods may affect device reliability.

## ELECTRICAL CHARACTERISTICS

(V<sub>DD</sub> = SHDN = 1.8V, GND = 0V, OUT has R<sub>L</sub> = 150Ω connected to GND, C1 = C2 = 1μF, T<sub>A</sub> = T<sub>MIN</sub> to T<sub>MAX</sub>, unless otherwise noted. Typical values are at T<sub>A</sub> = +25°C.) (Note 1)

| PARAMETER                       | SYMBOL            | CONDITIONS   |                                   | MIN   | TYP  | MAX   | UNITS             |
|---------------------------------|-------------------|--|-----------------------------------|-------|------|-------|-------------------|
| Supply Voltage Range            | V <sub>DD</sub>   | Guaranteed by PSRR   |                                   | 1.700 |      | 2.625 | V                 |
| Supply Current                  | I <sub>DD</sub>   | No load  | MAX9509                           |       | 3.1  | 5.3   | mA                |
|                                 |                   |  | MAX9510                           |       | 2.9  | 4.9   |                   |
| Shutdown Supply Current         | I <sub>SHDN</sub> | SHDN = GND   |                                   |       | 0.01 | 10    | μA                |
| Output Level                    |                   | IN = 80mV  |                                   | -75   | +5   | +75   | mV                |
| <b>DC-COUPLED INPUT</b>         |                   |  |                                   |       |      |       |                   |
| Input Voltage Range             |                   | Guaranteed by output voltage swing   | 1.7V ≤ V <sub>DD</sub> ≤ 2.625V   | 0     |      | 262.5 | mV                |
|                                 |                   |  | 2.375V ≤ V <sub>DD</sub> ≤ 2.625V | 0     |      | 325   |                   |
| Input Current                   | I <sub>B</sub>    | IN = 130mV   |                                   |       | 2    | 3.2   | μA                |
| Input Resistance                | R <sub>IN</sub>   | 10mV ≤ IN ≤ 250mV  |                                   |       | 280  |       | kΩ                |
| <b>AC-COUPLED INPUT</b>         |                   |  |                                   |       |      |       |                   |
| Sync-Tip Clamp Level            | V <sub>CCLP</sub> | C <sub>IN</sub> = 0.1μF  |                                   | -8    | 0    | +11   | mV                |
| Input-Voltage Swing             |                   | Guaranteed by output voltage swing   | 1.7V ≤ V <sub>DD</sub> ≤ 2.625V   |       |      | 252.5 | mV <sub>P-P</sub> |
|                                 |                   |  | 2.375V ≤ V <sub>DD</sub> ≤ 2.625V |       |      | 325   |                   |
| Sync Crush                      |                   | Percentage reduction in sync pulse at output, R <sub>SOURCE</sub> = 37.5Ω, C <sub>IN</sub> = 0.1μF |                                   |       | 1.6  |       | %                 |
| Input Clamping Current          |                   | IN = 130mV   |                                   |       | 2    | 3.2   | μA                |
| Line Time Distortion            |                   | C <sub>IN</sub> = 0.1μF  |                                   |       | 0.2  |       | %                 |
| Minimum Input Source Resistance |                   |  |                                   |       | 25   |       | Ω                 |

# 1.8V, Ultra-Low Power, DirectDrive Video Filter Amplifiers

MAX9509/MAX9510

## ELECTRICAL CHARACTERISTICS (continued)

( $V_{DD} = \overline{SHDN} = 1.8V$ ,  $GND = 0V$ , OUT has  $R_L = 150\Omega$  connected to GND,  $C_1 = C_2 = 1\mu F$ ,  $T_A = T_{MIN}$  to  $T_{MAX}$ , unless otherwise noted. Typical values are at  $T_A = +25^\circ C$ .) (Note 1)

| PARAMETER                                 | SYMBOL    | CONDITIONS  |   | MIN   | TYP   | MAX   | UNITS            |
|---|-----------|---|---|-------|-------|-------|------------------|
| <b>DC CHARACTERISTICS</b>                 |           |   |   |       |       |       |                  |
| DC Voltage Gain                           | $A_V$     | Guaranteed by output voltage swing (Note 2)   |   | 7.84  | 7.95  | 8.16  | V/V              |
| Output Voltage Swing                      |           | $1.7V \leq V_{DD} \leq 2.625V$  | $0V \leq V_{IN} \leq 262.5mV$ ,<br>DC-coupled input       | 2.058 | 2.1   | 2.142 | V <sub>P-P</sub> |
|   |           |   | $0V \leq V_{IN} \leq 252.5mV_{P-P}$ ,<br>AC-coupled input | 1.979 | 2.02  | 2.061 |                  |
|   |           | $2.375V \leq V_{DD} \leq 2.625V$  | $0V \leq V_{IN} \leq 325mV$                               | 2.548 | 2.6   | 2.652 |                  |
| Power-Supply Rejection Ratio              | PSRR      | $1.7V \leq V_{DD} \leq 2.625V$ , measured between $75\Omega$ load resistors                             |   | 46    | 60    |       | dB               |
| Shutdown Input Resistance                 |           | $0V \leq I_N \leq V_{DD}$ , $\overline{SHDN} = GND$   |   |       | 25    |       | $M\Omega$        |
| Output Resistance                         | $R_{OUT}$ | OUT = 0V, $-5mA \leq I_{LOAD} \leq +5mA$  |   |       | 0.1   |       | $\Omega$         |
| Shutdown Output Resistance                |           | $0V \leq OUT \leq V_{DD}$ , $\overline{SHDN} = GND$   |   |       | 32    |       | $M\Omega$        |
| OUT Leakage Current                       |           | $\overline{SHDN} = GND$   |   |       |       | 1     | $\mu A$          |
| Output Short-Circuit Current              |           | Sourcing  |   |       | 82    |       | mA               |
|   |           | Sinking   |   |       | 32    |       |                  |
| <b>AC CHARACTERISTICS (MAX9509)</b>       |           |   |   |       |       |       |                  |
| Standard-Definition Reconstruction Filter |           | OUT = 2V <sub>P-P</sub> ,<br>reference frequency is 100kHz  | $\pm 1dB$ passband flatness                               |       | 8.1   |       | MHz              |
|   |           |   | $f = 5.5MHz$  |       | +0.15 |       | dB               |
|   |           |   | $f = 10MHz$   |       | -3    |       |                  |
|   |           |   | $f = 27MHz$   |       | -46   |       |                  |
| Differential Gain                         | DG        | $f = 3.58MHz$   |   |       | 1.04  |       | %                |
|   |           | $f = 4.43MHz$   |   |       | 1.16  |       |                  |
| Differential Phase                        | DP        | $f = 3.58MHz$   |   |       | 0.54  |       | Degrees          |
|   |           | $f = 4.43MHz$   |   |       | 0.52  |       |                  |
| Group-Delay Distortion                    |           | $100kHz \leq f \leq 5MHz$ , OUT = 2V <sub>P-P</sub>   |   |       | 14    |       | ns               |
| Peak Signal to RMS Noise                  |           | $100kHz \leq f \leq 5MHz$   |   |       | 64    |       | dB               |
| Power-Supply Rejection Ratio              | PSRR      | $f = 100kHz$ , 100mV <sub>P-P</sub>   |   |       | 49    |       | dB               |
| 2T Pulse-to-Bar K Rating                  |           | 2T = 200ns, bar time is 18 $\mu s$ , the beginning 2.5% and the ending 2.5% of the bar time are ignored |   |       | 0.1   |       | K%               |
| 2T Pulse Response                         |           | 2T = 200ns  |   |       | 0.3   |       | K%               |
| 2T Bar Response                           |           | 2T = 200ns, bar time is 18 $\mu s$ , the beginning 2.5% and the ending 2.5% of the bar time are ignored |   |       | 0.1   |       | K%               |
| Nonlinearity                              |           | 5-step staircase  |   |       | 0.2   |       | %                |
| Output Impedance                          |           | $f = 5MHz$ , $I_N = 80mV$   |   |       | 6.4   |       | $\Omega$         |

# 1.8V, Ultra-Low Power, DirectDrive Video Filter Amplifiers

## ELECTRICAL CHARACTERISTICS (continued)

( $V_{DD} = \overline{SHDN} = 1.8V$ ,  $GND = 0V$ , OUT has  $R_L = 150\Omega$  connected to GND,  $C_1 = C_2 = 1\mu F$ ,  $T_A = T_{MIN}$  to  $T_{MAX}$ , unless otherwise noted. Typical values are at  $T_A = +25^\circ C$ .) (Note 1)

| PARAMETER                           | SYMBOL              | CONDITIONS  | MIN | TYP  | MAX  | UNITS      |
|-------------------------------------|---------------------|---|-----|------|------|------------|
| OUT-to-IN Isolation                 |                     | $\overline{SHDN} = GND$ , $f \leq 5.5MHz$   |     | 102  |      | dB         |
| IN-to-OUT Isolation                 |                     | $\overline{SHDN} = GND$ , $f \leq 5.5MHz$   |     | 99   |      | dB         |
| <b>AC CHARACTERISTICS (MAX9510)</b> |                     |   |     |      |      |            |
| Small-Signal -3dB Bandwidth         |                     | OUT = 100mV <sub>P-P</sub>  |     | 42.1 |      | MHz        |
| Large-Signal -3dB Bandwidth         |                     | OUT = 2V <sub>P-P</sub>   |     | 11.4 |      | MHz        |
| Small-Signal 1dB Flatness           |                     | OUT = 100mV <sub>P-P</sub>  |     | 36.1 |      | MHz        |
| Large-Signal 1dB Flatness           |                     | OUT = 2V <sub>P-P</sub>   |     | 8.4  |      | MHz        |
| Slew Rate                           |                     | OUT = 2V step   |     | 43   |      | V/ $\mu s$ |
| Settling Time to 0.1%               |                     | OUT = 2V step   |     | 124  |      | ns         |
| Differential Gain                   | DG                  | $f = 3.58MHz$   |     | 0.70 |      | %          |
|                                     |                     | $f = 4.43MHz$   |     | 0.93 |      |            |
| Differential Phase                  | DP                  | $f = 3.58MHz$   |     | 0.69 |      | Degrees    |
|                                     |                     | $f = 4.43MHz$   |     | 0.83 |      |            |
| Group-Delay Distortion              |                     | $100kHz \leq f \leq 5MHz$ , OUT = 2V <sub>P-P</sub>   |     | 6    |      | ns         |
| Peak Signal to RMS Noise            |                     | $100kHz \leq f \leq 5MHz$   |     | 67   |      | dB         |
| Power-Supply Rejection Ratio        | PSRR                | $f = 100kHz$ , 100mV <sub>P-P</sub>   |     | 45   |      | dB         |
| 2T Pulse-to-Bar K Rating            |                     | 2T = 200ns, bar time is 18 $\mu s$ , the beginning 2.5% and the ending 2.5% of the bar time are ignored |     | 0.2  |      | K%         |
| 2T Pulse Response                   |                     | 2T = 200ns  |     | 0.2  |      | K%         |
| 2T Bar Response                     |                     | 2T = 200ns, bar time is 18 $\mu s$ , the beginning 2.5% and the ending 2.5% of the bar time are ignored |     | 0.1  |      | K%         |
| Nonlinearity                        |                     | 5-step staircase  |     | 0.1  |      | %          |
| Output Impedance                    |                     | $f = 5MHz$ , IN = 80mV  |     | 7.3  |      | $\Omega$   |
| OUT-to-IN Isolation                 |                     | $\overline{SHDN} = GND$ , $f \leq 5MHz$   |     | 98   |      | dB         |
| IN-to-OUT Isolation                 |                     | $\overline{SHDN} = GND$ , $f \leq 5MHz$   |     | 94   |      | dB         |
| <b>CHARGE PUMP</b>                  |                     |   |     |      |      |            |
| Switching Frequency                 |                     |   | 325 | 625  | 1150 | kHz        |
| <b>SHDN INPUT</b>                   |                     |   |     |      |      |            |
| Logic-Low Threshold                 | $V_{IL}$            | $V_{DD} = 1.7V$ to 2.625V   |     | 0.5  |      | V          |
| Logic-High Threshold                | $V_{IH}$            | $V_{DD} = 1.7V$ to 2.625V   | 1.4 |      |      | V          |
| Logic Input Current                 | $I_{IL}$ , $I_{IH}$ |   |     |      | 10   | $\mu A$    |

**Note 1:** All devices are 100% production tested at  $T_A = +25^\circ C$ . Specifications over temperature limits are guaranteed by design.

**Note 2:** Voltage gain ( $A_V$ ) is a two-point measurement in which the output-voltage swing is divided by the input-voltage swing.

# 1.8V, Ultra-Low Power, DirectDrive Video Filter Amplifiers

## Typical Operating Characteristics

( $V_{DD} = \overline{\text{SHDN}} = 1.8\text{V}$ ,  $\text{GND} = 0\text{V}$ , DC-coupled input, video output has  $R_L = 150\Omega$  connected to  $\text{GND}$ ,  $T_A = +25^\circ\text{C}$ , unless otherwise noted.)

MAX9509/MAX9510

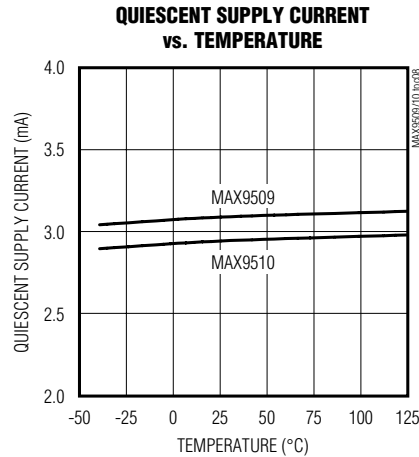
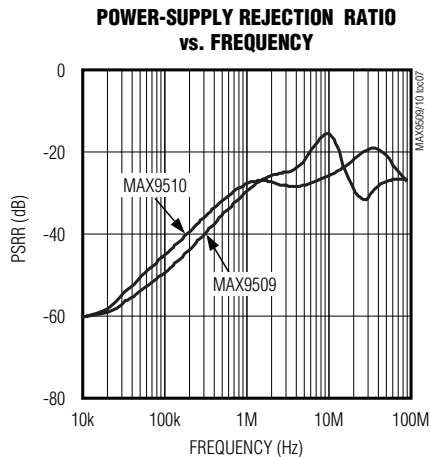
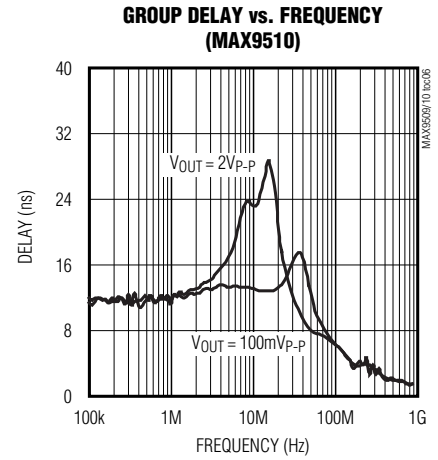
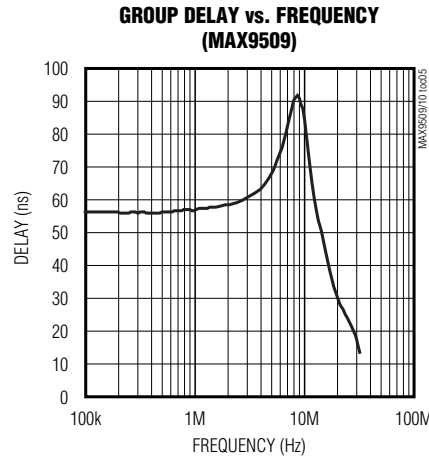
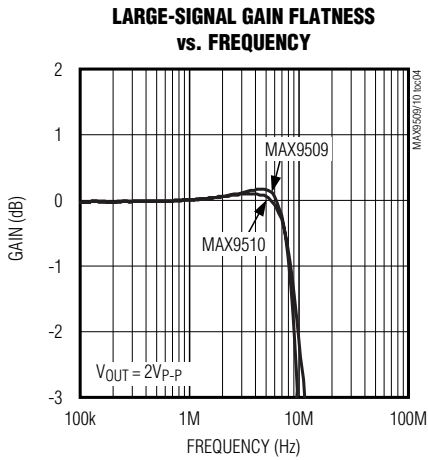
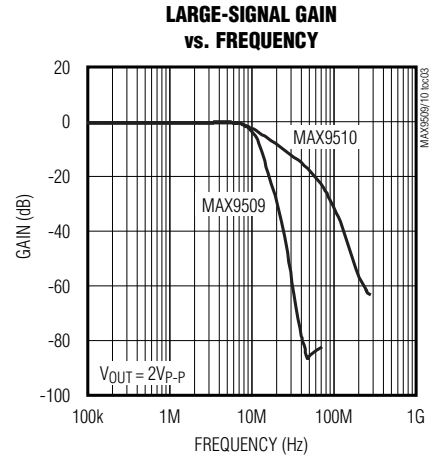
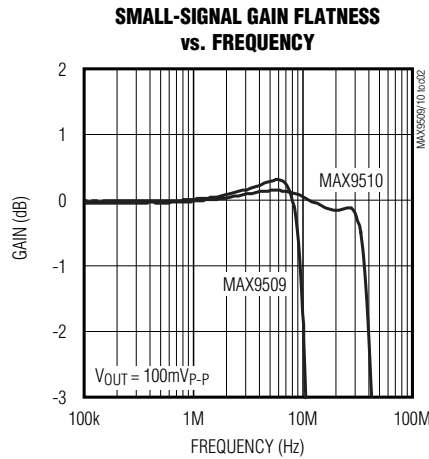
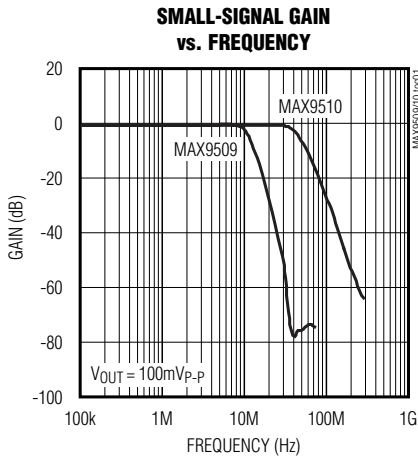

# 1.8V, Ultra-Low Power, DirectDrive Video Filter Amplifiers

## Typical Operating Characteristics (continued)

( $V_{DD} = \overline{SHDN} = 1.8V$ ,  $GND = 0V$ , DC-coupled input, video output has  $R_L = 150\Omega$  connected to  $GND$ ,  $T_A = +25^\circ C$ , unless otherwise noted.)

**VOLTAGE GAIN vs. TEMPERATURE**

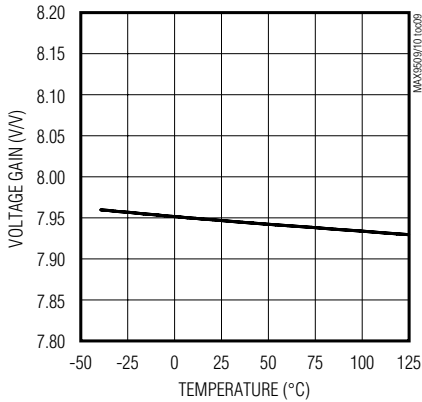

**OUTPUT VOLTAGE vs. INPUT VOLTAGE**

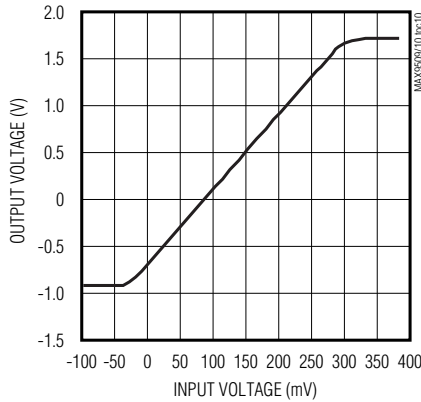

**DIFFERENTIAL GAIN AND PHASE (MAX9509)**

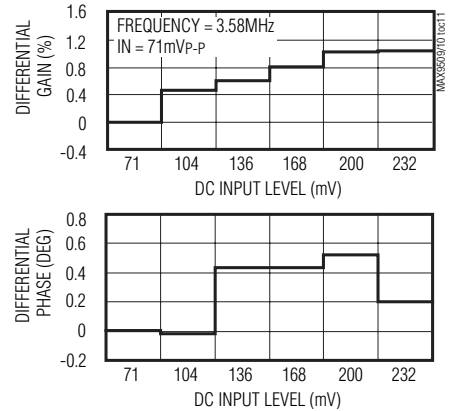

**DIFFERENTIAL GAIN AND PHASE (MAX9509)**

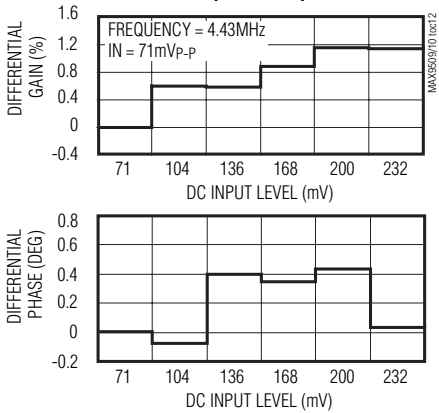

**DIFFERENTIAL GAIN AND PHASE (MAX9510)**

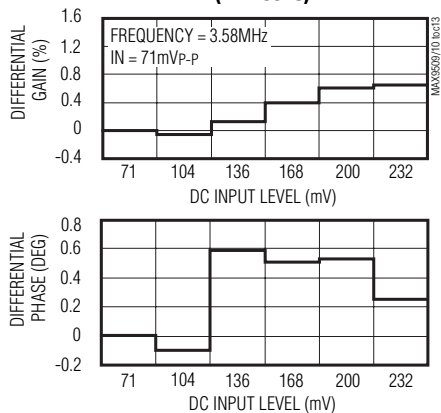

**DIFFERENTIAL GAIN AND PHASE (MAX9510)**

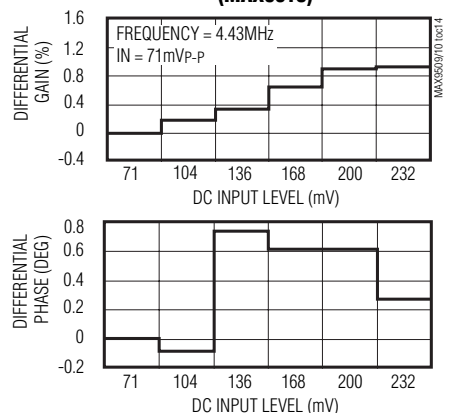

**2T RESPONSE**

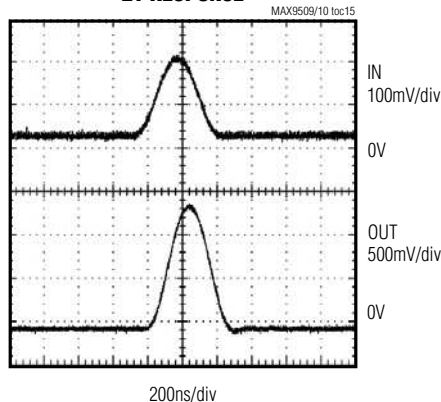

**12.5T RESPONSE**

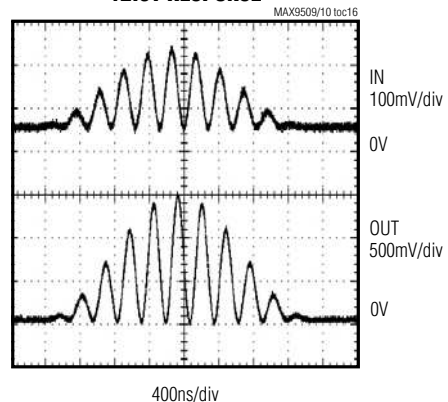

# 1.8V, Ultra-Low Power, DirectDrive Video Filter Amplifiers

## Typical Operating Characteristics (continued)

( $V_{DD} = \overline{\text{SHDN}} = 1.8\text{V}$ ,  $\text{GND} = 0\text{V}$ , DC-coupled input, video output has  $R_L = 150\Omega$  connected to  $\text{GND}$ ,  $T_A = +25^\circ\text{C}$ , unless otherwise noted.)

MAX9509/MAX9510

**OUTPUT RESPONSE TO NTC-7 VIDEO TEST SIGNAL**

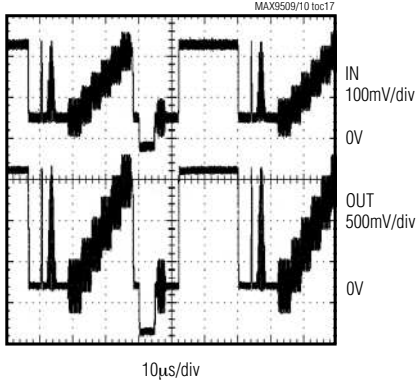

**PAL MULTIBURST RESPONSE**

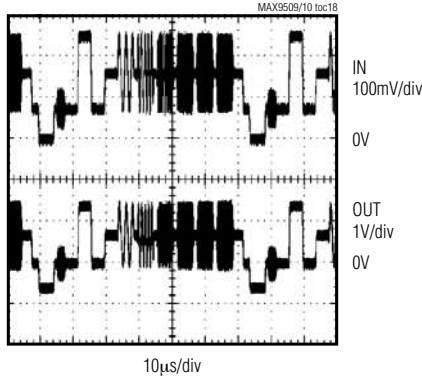

**PAL COLOR BARS**

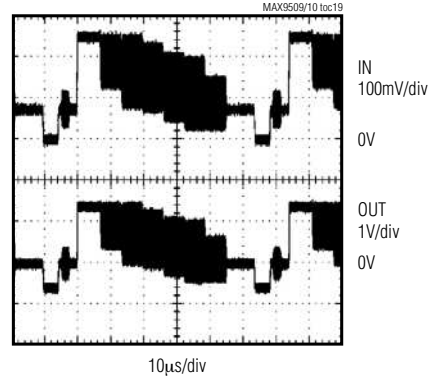

**FIELD SQUARE-WAVE RESPONSE (AC-COUPLED INPUT)**

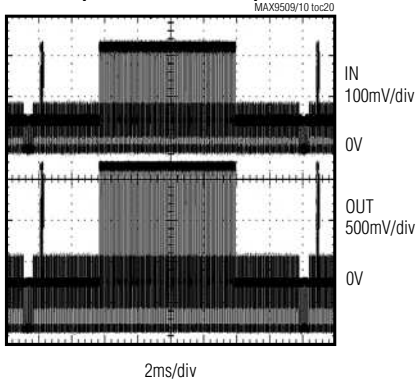

**SMALL-SIGNAL PULSE RESPONSE (MAX9510)**

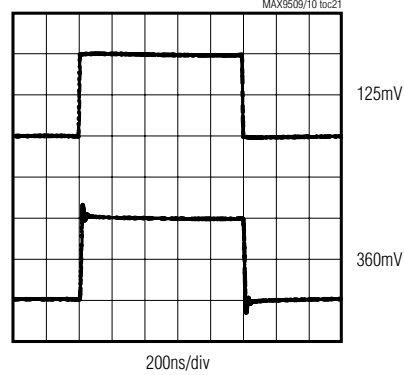

**LARGE-SIGNAL PULSE RESPONSE (MAX9510)**

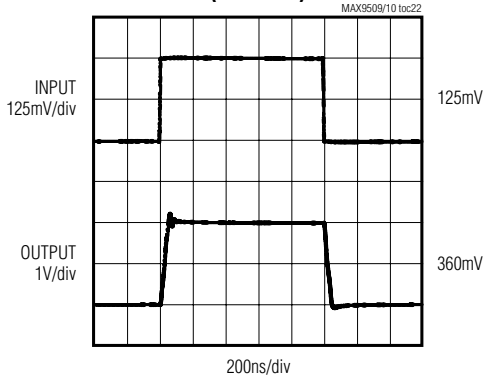

**ENABLE RESPONSE**

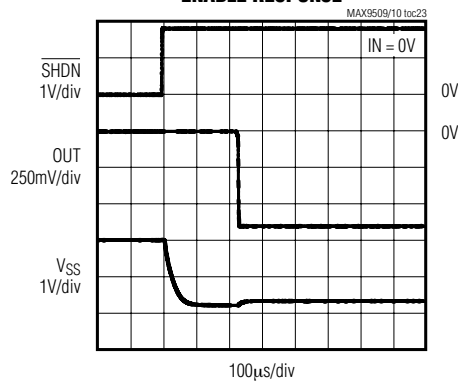

**DISABLE RESPONSE**

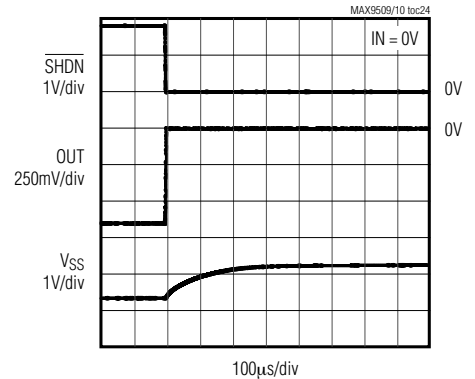



# 1.8V, Ultra-Low Power, DirectDrive Video Filter Amplifiers

## Pin Description

| PIN     |         | NAME            | FUNCTION   |
|---------|---------|-----------------|--|
| MAX9509 | MAX9510 |                 |  |
| 1       | 1       | V <sub>SS</sub> | Charge-Pump Negative Power Supply. Bypass with a 1μF capacitor to GND.                   |
| 2       | 2       | C1N             | Charge-Pump Flying Capacitor Negative Terminal. Connect a 1μF capacitor from C1P to C1N. |
| 3       | 3       | GND             | Ground   |
| 4       | 4       | C1P             | Charge-Pump Flying Capacitor Positive Terminal. Connect a 1μF capacitor from C1P to C1N. |
| 5       | 5       | V <sub>DD</sub> | Positive Power Supply. Bypass with a 0.1μF capacitor to GND.                             |
| 6       | 6       | IN              | Video Input  |
| 7       | 7       | SHDN            | Active-Low Shutdown. Connect to V <sub>DD</sub> for normal operation.                    |
| 8       | 8       | OUT             | Video Output   |
| EP      | —       | EP              | Exposed Paddle. EP is internally connected to GND. Connect EP to GND.                    |

## Detailed Description

The MAX9509/MAX9510 represent Maxim's second generation of DirectDrive video amplifiers that meet the requirements of current and future portable equipment:

- 1.8V operation. Engineers want to eliminate the 3.3V supply in favor of lower supply voltages.
- Lower power consumption. The MAX9509/MAX9510 reduce average power consumption by up to 75% compared to the 3.3V first generation (MAX9503/MAX9505).
- Internal fixed gain of 8. As the supply voltages drop for system chips on deep submicron processes, the video DAC can no longer create a 1V<sub>P-P</sub> signal at its output, and the gain of 2 found in the previous generation of video filter amplifiers is not enough.

DirectDrive technology is necessary for a voltage mode amplifier to output a 2V<sub>P-P</sub> video signal from a 1.8V supply. The integrated inverting charge pump creates a negative supply that increases the output range and gives the video amplifier enough headroom to drive a 2V<sub>P-P</sub> video signal with a 150Ω load.

### DirectDrive Background

Integrated video filter amplifier circuits operate from a single supply. The positive power supply usually creates video output signals that are level-shifted above

ground to keep the signal within the linear range of the output amplifier. For applications where the positive DC level is not acceptable, a series capacitor can be inserted in the output connection in an attempt to eliminate the positive DC level shift. The series capacitor cannot truly level-shift a video signal because the average level of the video varies with picture content. The series capacitor biases the video output signal around ground, but the actual level of the video signal can vary significantly depending upon the RC time constant and the picture content.

The series capacitor creates a highpass filter. Since the lowest frequency in video is the frame rate, which can be from 24Hz to 30Hz, the pole of the highpass filter should ideally be an order of magnitude lower in frequency than the frame rate. Therefore, the series capacitor must be very large, typically from 220μF to 3000μF. For space-constrained equipment, the series capacitor is unacceptable. Changing from a single series capacitor to a SAG network that requires two smaller capacitors only reduces space and cost slightly.

The series capacitor in the usual output connection also prevents damage to the output amplifier if the connector is shorted to a supply or to ground. While the output connection of the MAX9509/MAX9510 does not have a series capacitor, the MAX9509/MAX9510 will not be damaged if the connector is shorted to a supply or to ground (see the *Short-Circuit Protection* section).

# 1.8V, Ultra-Low Power, DirectDrive Video Filter Amplifiers

## Video Amplifier

If the full-scale video signal from a video DAC is 250mV, the black level of the video signal created by the video DAC is approximately 75mV. The MAX9509/MAX9510 shift the black level to near ground at the output so that the active video is above ground and the sync is below ground. The amplifier needs a negative supply for its output stage to remain in its linear region when driving sync below ground.

The MAX9509/MAX9510 have an integrated charge pump and linear regulator to create a low-noise negative supply from the positive supply voltage. The charge pump inverts the positive supply to create a raw negative voltage that is then fed into the linear regulator filtering out the charge-pump noise.

## Comparison Between DirectDrive Output and AC-Coupled Output

The actual level of the video signal varies less with a DirectDrive output than an AC-coupled output. The average video signal level can change greatly depending upon the picture content. With an AC-coupled output, the average level will change according to the time constant formed by the series capacitor and series resistance (usually 150Ω). For example, Figure 1 shows an AC-coupled video signal alternating between a completely black screen and a completely white screen. Notice the excursion of the video signal as the screen changes.

With the DirectDrive amplifier, the black level is held at ground. The video signal is constrained between -0.3V and +0.7V. Figure 2 shows the video signal from a DirectDrive amplifier with the same input signal as the AC-coupled system.

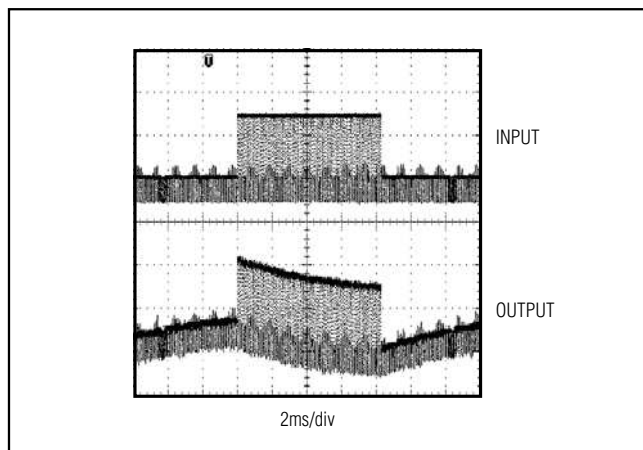

Figure 1. AC-Coupled Output

## Video Reconstruction Filter (MAX9509)

The MAX9509 includes an internal five-pole, Butterworth lowpass filter to condition the video signal. The reconstruction filter smooths the steps and reduces the spikes created whenever the DAC output changes value. In the frequency domain, the steps and spikes cause images of the video signal to appear at multiples of the sampling clock frequency. The reconstruction filter typically has  $\pm 1$ dB passband flatness of 8.1MHz and 46dB attenuation at 27MHz.

## Transparent Sync-Tip Clamp

The MAX9509/MAX9510 contain an integrated, transparent sync-tip clamp. When using a DC-coupled input, the sync-tip clamp does not affect the input signal, as long as it remains above ground. When using an AC-coupled input, the transparent sync-tip clamp automatically clamps the input signal to ground, preventing it from going lower. A small current of 2μA pulls down on the input to prevent an AC-coupled signal from drifting outside the input range of the part.

Using an AC-coupled input will result in some additional variation of the black level at the output. Applying a voltage above ground to the input pin of the device always produces the same output voltage, regardless of whether the input is DC- or AC-coupled. However, since the Sync-Tip Clamp Level ( $V_{CLP}$ ) can vary over a small range, the video black level at the output of the device when using an AC-coupled input can vary by an additional amount equal to the  $V_{CLP}$  multiplied by the DC Voltage Gain ( $A_V$ ).

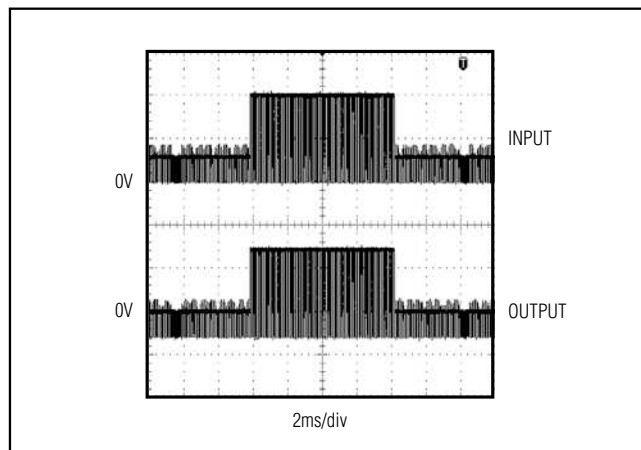

Figure 2. DirectDrive Output

# 1.8V, Ultra-Low Power, DirectDrive Video Filter Amplifiers

## Short-Circuit Protection

The MAX9509/MAX9510 *Functional Diagram/Typical Application Circuit* includes a  $75\Omega$  back-termination resistor that limits short-circuit current if an external short is applied to the video output. The MAX9509/MAX9510 also feature internal output short-circuit protection to prevent device damage in prototyping and applications where the amplifier output can be directly shorted.

## Shutdown

The MAX9509/MAX9510 feature a low-power shutdown mode for battery-powered/portable applications. Shutdown reduces the quiescent current to less than  $10\text{nA}$ . Connecting  $\overline{\text{SHDN}}$  to ground (GND) disables the output and places the MAX9509/MAX9510 into a low-power shutdown mode. In shutdown mode, the sync-tip clamp, filter (MAX9509), amplifier, charge pump, and linear regulator are turned off and the video output is high impedance.

## Applications Information

### Power Consumption

The quiescent power consumption and average power consumption of the MAX9509/MAX9510 are remarkably low because of 1.8V operation and DirectDrive technology. Quiescent power consumption is defined when the MAX9509/MAX9510 are operating without load. In this case, the MAX9509/MAX9510 consume approximately  $5.8\text{mW}$ . Average power consumption, which is defined when the MAX9509/MAX9510 drive a  $150\Omega$  load to ground with a 50% flat field, is about  $11.7\text{mW}$ . Table 1 shows the power consumption with different video signals. The supply voltage is 1.8V. OUT drives a  $150\Omega$  load to ground.

**Table 1. Power Consumption of MAX9509/MAX9510 with Different Video Signals**

| VIDEO SIGNAL     | MAX9509 POWER CONSUMPTION (mW) | MAX9510 POWER CONSUMPTION (mW) |
|------------------|--------------------------------|--------------------------------|
| All Black Screen | 6.7                            | 6.2                            |
| All White Screen | 18.2                           | 17.9                           |
| 75% Color Bars   | 11.6                           | 11.0                           |
| 50% Flat Field   | 11.7                           | 11.3                           |

Notice that the two extremes in power consumption occur with a video signal that is all black and a video signal that is all white. The power consumption with 75% color bars and 50% flat field lies in between the extremes.

## Interfacing to Video DACs that Produce Video Signals Larger than $0.25\text{V}_{\text{P-P}}$

Devices designed to generate  $1\text{V}_{\text{P-P}}$  video signals at the output of the video DAC can still work with the MAX9509/MAX9510. Most video DACs source current into a ground-referenced resistor, which converts the current into a voltage. Figure 3 shows a video DAC that creates a video signal from 0 to 1V across a  $150\Omega$  resistor. The following video filter amplifier has a gain of  $2\text{V/V}$  so that the output is  $2\text{V}_{\text{P-P}}$ .

The MAX9509/MAX9510 expect input signals that are  $0.25\text{V}_{\text{P-P}}$  nominally. The same video DAC can be made to work with the MAX9509/MAX9510 by scaling down the  $150\Omega$  resistor to a  $37.5\Omega$  resistor, as shown in Figure 4. The  $37.5\Omega$  resistor is 1/4 the size of the  $150\Omega$  resistor, resulting in a video signal that is 1/4 the amplitude.

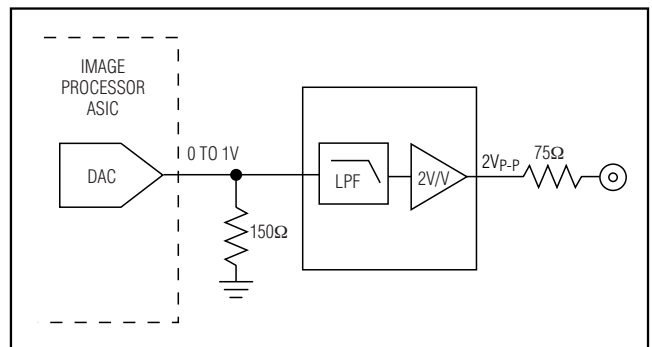

Figure 3. The video DAC generates a  $1\text{V}_{\text{P-P}}$  signal across a  $150\Omega$  resistor connected to ground.

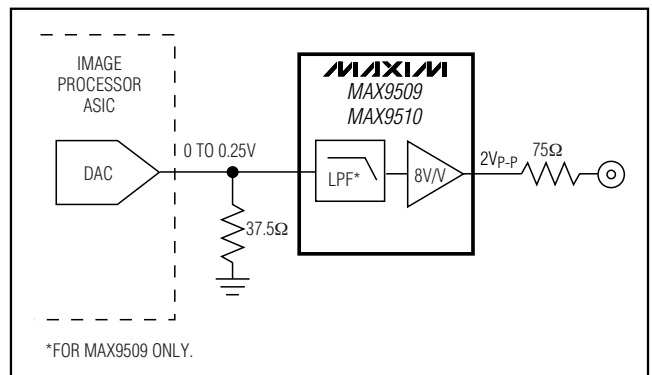

Figure 4. The video DAC generates a  $0.25\text{V}_{\text{P-P}}$  signal across a  $37.5\Omega$  resistor connected to ground.

# 1.8V, Ultra-Low Power, DirectDrive Video Filter Amplifiers

## Anti-Alias Filter

The MAX9509 can also provide anti-alias filtering with a buffer before an ADC, which would be present in a NTSC/PAL video decoder, for example. Figure 5 shows an example application circuit. An external composite video signal is applied to VIDIN, which is terminated with a total of 74Ω (56Ω and 18Ω resistors) to ground. The signal is attenuated by four, and then AC-coupled to IN. The normal 1V<sub>P-P</sub> video signal must be attenuated because with a 1.8V supply, the MAX9509 can only handle a video signal of approximately 0.25V<sub>P-P</sub> at IN.

AC-couple the video signal to IN because the DC level of an external video signal is usually not well specified, although it is reasonable to expect that the signal is between -2V and +2V. The 10Ω series resistor increases the equivalent source resistance to approximately 25Ω, which is the minimum necessary for a video source to drive the internal sync-tip clamp.

For external video signals larger than 1V<sub>P-P</sub>, operate the MAX9509 from a 2.5V supply so that IN can accommodate a 0.325V<sub>P-P</sub> video signal, which is equivalent to a 1.3V<sub>P-P</sub> video signal at VIDIN.

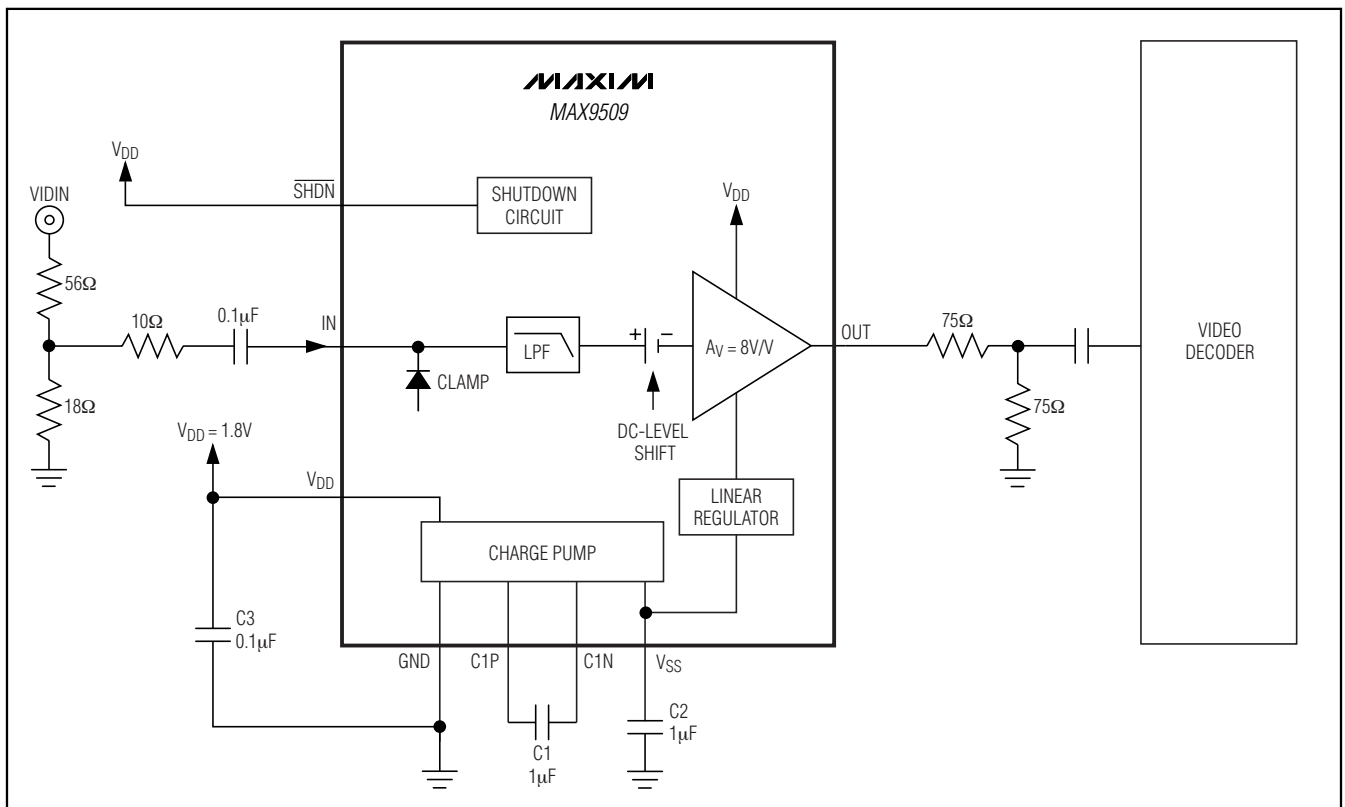

Figure 5. MAX9509 Used as an Anti-Alias Filter with Buffer

# 1.8V, Ultra-Low Power, DirectDrive Video Filter Amplifiers

## Video Source with a Positive DC Bias

In some applications, the video source generates a signal with a positive DC voltage bias, i.e., the sync tip of the signal is well above ground. Figure 6 shows an example in which the outputs of the luma (Y) DAC and the chroma (C) DAC are connected together. Since the DACs are current-mode, the output currents sum together into the resistor, which converts the resulting current into a voltage representing a composite video signal.

If the chroma DAC has an independent output resistor to ground, then the chroma signal, which is a carrier at 3.58MHz for NTSC or at 4.43MHz for PAL, has a positive DC bias to keep the signal above ground at all times. If the luma DAC has an independent output

resistor to ground, then the luma signal usually does not have a positive DC bias, and the sync tip is at approximately ground. When the chroma and luma signals are added together, the resulting composite video signal still has a positive DC bias. Therefore, the signal must be AC-coupled into the MAX9509/MAX9510 because the composite video signal is above the nominal, DC-coupled input range of 0 to 0.25V.

## Video Signal Routing

Minimize the length of the PCB trace between the output of the video DAC and the input of the MAX9509/MAX9510 to reduce coupling of external noise into the video signal. If possible, shield the PCB trace.

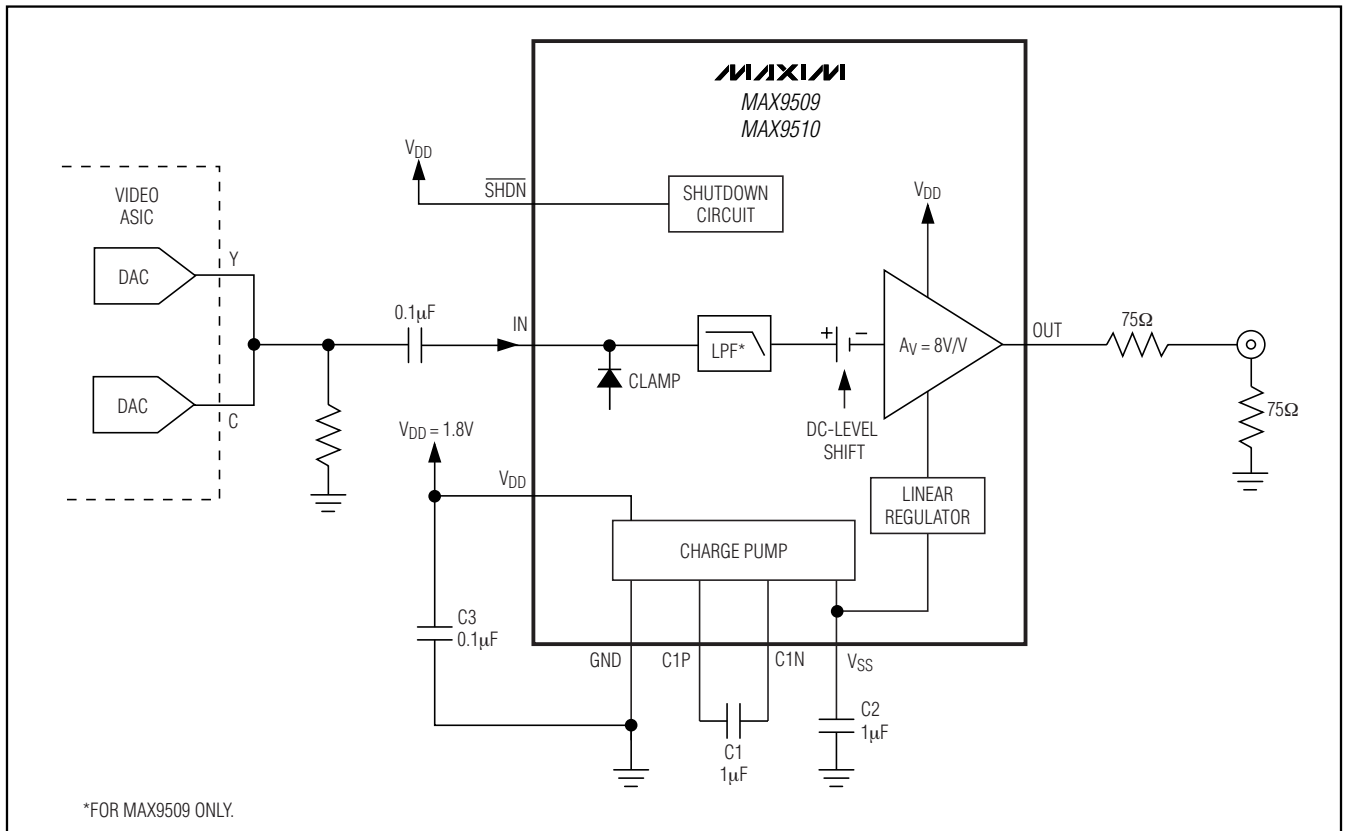

Figure 6. Luma (Y) and chroma (C) signals are added together to create a composite video signal, which is AC-coupled into the MAX9509/MAX9510.

# 1.8V, Ultra-Low Power, DirectDrive Video Filter Amplifiers

## Power-Supply Bypassing and Ground Management

The MAX9509/MAX9510 operate from a 1.7V to 2.625V single supply and require proper layout and bypassing. For the best performance, place the components as close to the device as possible.

Proper grounding improves performance and prevents any switching noise from coupling into the video signal. Bypass the analog supply ( $V_{DD}$ ) with a  $0.1\mu\text{F}$  capacitor to GND, placed as close to the device as possible. Bypass  $V_{SS}$  with a  $1\mu\text{F}$  capacitor to GND as close to the device as possible. The total system bypass capacitance on  $V_{DD}$  should be at least  $10\mu\text{F}$  or ten times the capacitance between C1P and C1N.

## Using a Digital Supply

The MAX9509/MAX9510 were designed to operate from noisy digital supplies. The high PSRR (49dB at 100kHz) allows the MAX9509/MAX9510 to reject the noise from the digital power supplies (see the *Typical Operating Characteristics*). If the digital power supply is very noisy and stripes appear on the television screen, increase the supply bypass capacitance. An additional, smaller capacitor in parallel with the main bypass capacitor can reduce digital supply noise because the smaller capacitor has lower equivalent series resistance (ESR) and equivalent series inductance (ESL).

## Functional Diagram/Typical Application Circuit

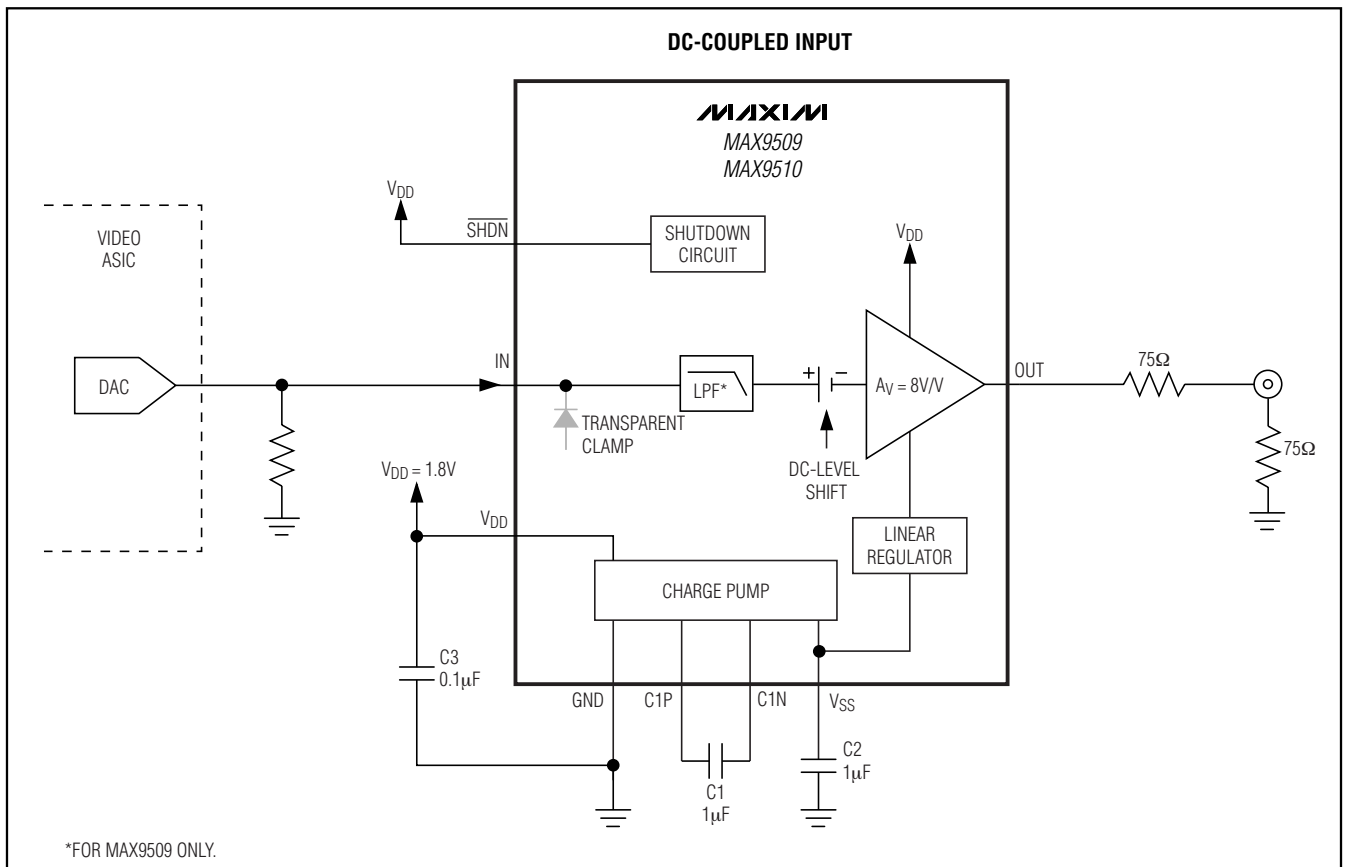

# 1.8V, Ultra-Low Power, DirectDrive Video Filter Amplifiers

## Pin Configurations

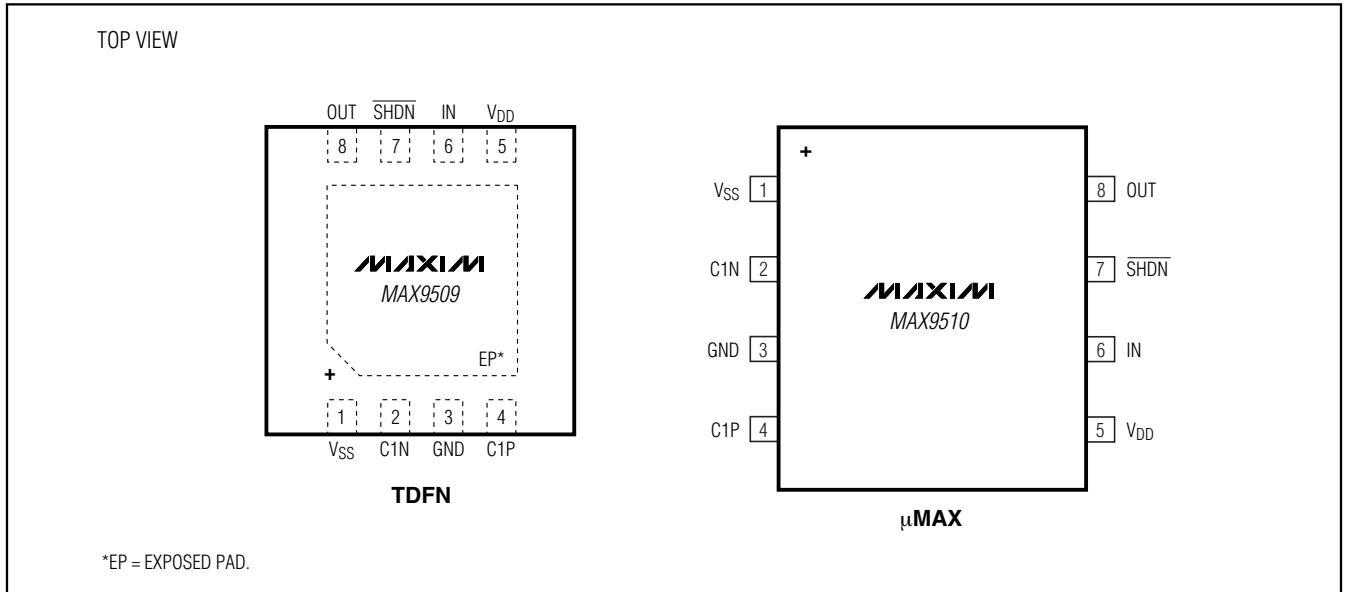

## Chip Information

PROCESS: BiCMOS

# 1.8V, Ultra-Low Power, DirectDrive Video Filter Amplifiers

## Package Information

(The package drawing(s) in this data sheet may not reflect the most current specifications. For the latest package outline information go to [www.maxim-ic.com/packages](http://www.maxim-ic.com/packages).)

8L TDFN EXPOSED PADS.EPS

**MAX9509/MAX9510**

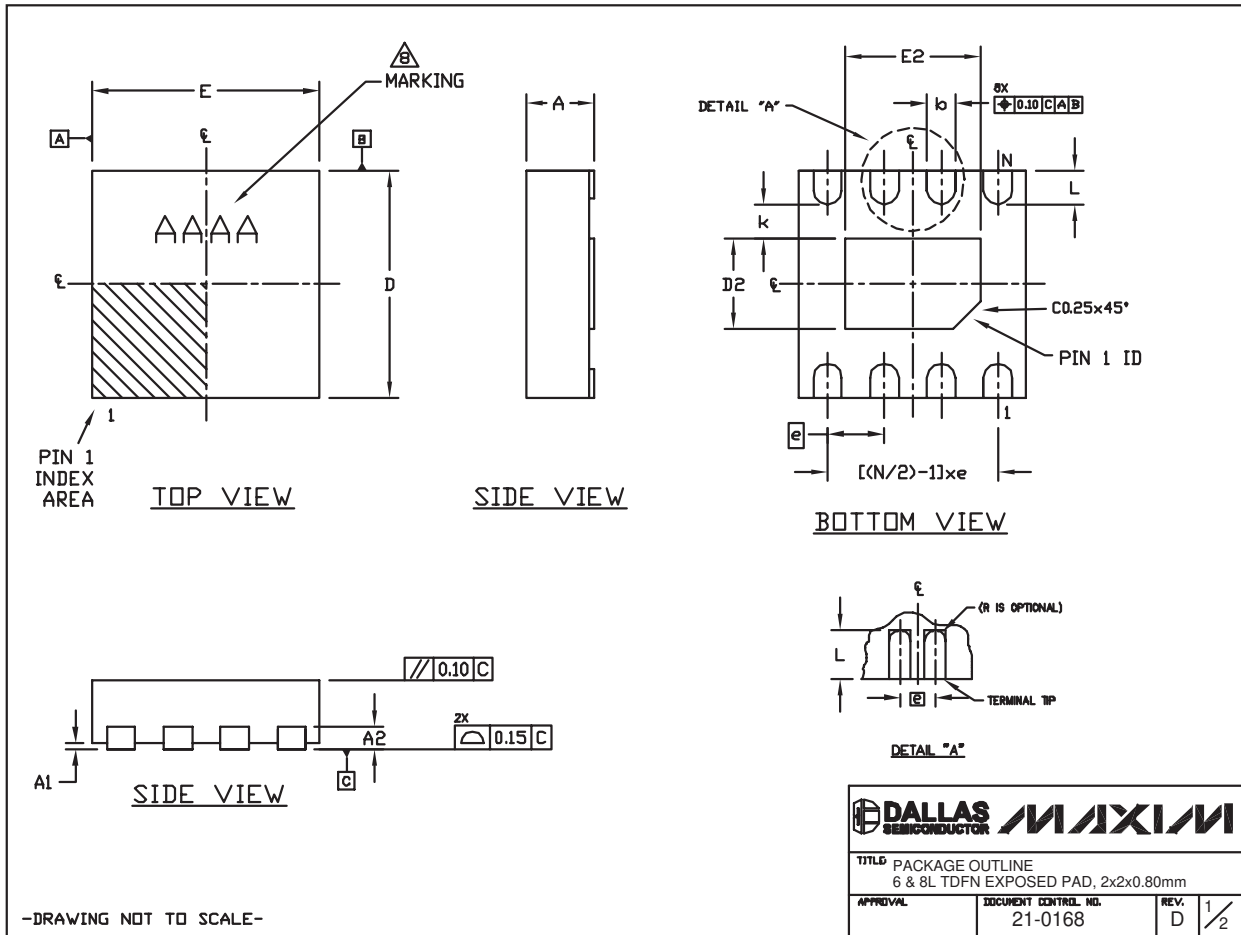



# 1.8V, Ultra-Low Power, DirectDrive Video Filter Amplifiers

## Package Information (continued)

(The package drawing(s) in this data sheet may not reflect the most current specifications. For the latest package outline information go to [www.maxim-ic.com/packages](http://www.maxim-ic.com/packages).)

| COMMON DIMENSIONS |           |      |
|-------------------|-----------|------|
| SYMBOL            | MIN.      | MAX. |
| A                 | 0.70      | 0.80 |
| D                 | 1.90      | 2.10 |
| E                 | 1.90      | 2.10 |
| A1                | 0.00      | 0.05 |
| L                 | 0.20      | 0.40 |
| k                 | 0.25 MIN. |      |
| A2                | 0.20 REF. |      |

| PACKAGE VARIATIONS |   |           |           |           |           |       |               |
|--------------------|---|-----------|-----------|-----------|-----------|-------|---------------|
| PKG. CODE          | N | D2        | E2        | e         | b         | r     | [(N/2)-1] x e |
| T622-1             | 6 | 0.90±0.10 | 1.60±0.10 | 0.65 TYP. | 0.30±0.05 | 0.150 | 1.30 REF      |
| T822-1             | 8 | 0.70±0.10 | 1.30±0.10 | 0.50 TYP. | 0.25±0.05 | 0.125 | 1.50 REF      |
| T822-2             | 8 | 0.80±0.10 | 1.20±0.10 | 0.50 TYP. | 0.25±0.05 | 0.125 | 1.50 REF      |

**NOTES:**

1. ALL DIMENSIONS ARE IN mm. ANGLES IN DEGREES.
  2. COPLANARITY APPLIES TO THE EXPOSED PAD AS WELL AS THE TERMINALS. COPLANARITY SHALL NOT EXCEED 0.08 mm.
  3. WARPAGE SHALL NOT EXCEED 0.08 mm.
  4. PACKAGE LENGTH/PACKAGE WIDTH ARE CONSIDERED AS SPECIAL CHARACTERISTIC(S).
  5. COMPLY TO JEDEC MO229 EXCEPT D2 AND E2 DIMENSIONS.
  6. "N" IS THE TOTAL NUMBER OF LEADS.
  7. NUMBER OF LEADS SHOWN ARE FOR REFERENCE ONLY.
- ⚠ MARKING IS FOR PACKAGE ORIENTATION REFERENCE ONLY.

|  |  |                      |
|--|--|----------------------|
|  |  |                      |
| <b>TITLE</b> PACKAGE OUTLINE<br>6 & 8L TDFN EXPOSED PAD, 2x2x0.80mm                  |  |                      |
| <b>APPROVAL</b>  | <b>DOCUMENT CONTROL NO.</b><br>21-0168 | <b>REV.</b><br>D 2/2 |

-DRAWING NOT TO SCALE-

# 1.8V, Ultra-Low Power, DirectDrive Video Filter Amplifiers

## Package Information (continued)

(The package drawing(s) in this data sheet may not reflect the most current specifications. For the latest package outline information go to [www.maxim-ic.com/packages](http://www.maxim-ic.com/packages).)

8LUMAXD.EPS

**MAX9509/MAX9510**

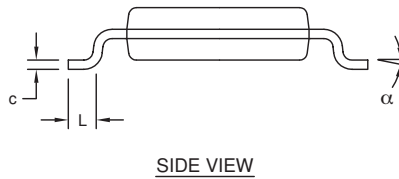
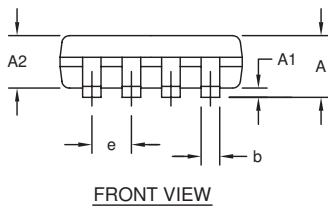
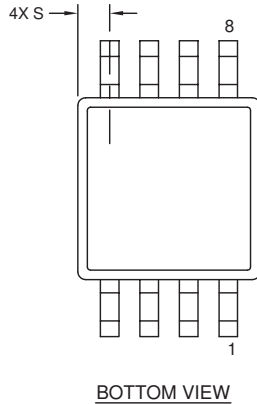
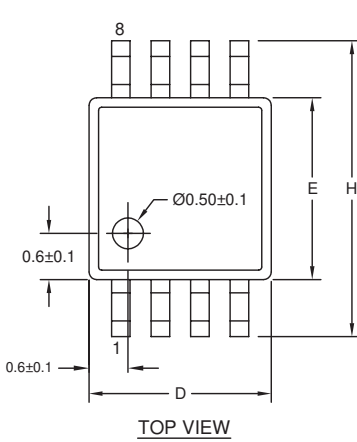

| DIM | INCHES     |       | MILLIMETERS |      |
|-----|------------|-------|-------------|------|
|     | MIN        | MAX   | MIN         | MAX  |
| A   | -          | 0.043 | -           | 1.10 |
| A1  | 0.002      | 0.006 | 0.05        | 0.15 |
| A2  | 0.030      | 0.037 | 0.75        | 0.95 |
| b   | 0.010      | 0.014 | 0.25        | 0.36 |
| c   | 0.005      | 0.007 | 0.13        | 0.18 |
| D   | 0.116      | 0.120 | 2.95        | 3.05 |
| e   | 0.0256 BSC |       | 0.65 BSC    |      |
| E   | 0.116      | 0.120 | 2.95        | 3.05 |
| H   | 0.188      | 0.198 | 4.78        | 5.03 |
| L   | 0.016      | 0.026 | 0.41        | 0.66 |
| α   | 0°         | 6°    | 0°          | 6°   |
| S   | 0.0207 BSC |       | 0.5250 BSC  |      |

**NOTES:**

1. D&E DO NOT INCLUDE MOLD FLASH.
2. MOLD FLASH OR PROTRUSIONS NOT TO EXCEED 0.15MM (.006").
3. CONTROLLING DIMENSION: MILLIMETERS.
4. MEETS JEDEC MO-187C-AA.

|  |  |                              |
|--|--|------------------------------|
|  |  |                              |
| <small>PROPRIETARY INFORMATION</small>                 |  |                              |
| <small>TITLE:</small><br>PACKAGE OUTLINE, 8L uMAX/uSOP |  |                              |
| <small>APPROVAL</small>                                | <small>DOCUMENT CONTROL NO.</small><br>21-0036 | <small>REV.</small><br>J 1/1 |

## Revision History

Pages changed at Rev 1: 1, 2, 7, 9, 13, 15-17

Maxim cannot assume responsibility for use of any circuitry other than circuitry entirely embodied in a Maxim product. No circuit patent licenses are implied. Maxim reserves the right to change the circuitry and specifications without notice at any time.

Maxim Integrated Products, 120 San Gabriel Drive, Sunnyvale, CA 94086 408-737-7600 \_\_\_\_\_ 17