



Chipsmall Limited consists of a professional team with an average of over 10 year of expertise in the distribution of electronic components. Based in Hongkong, we have already established firm and mutual-benefit business relationships with customers from,Europe,America and south Asia,supplying obsolete and hard-to-find components to meet their specific needs.

With the principle of “Quality Parts,Customers Priority,Honest Operation,and Considerate Service”,our business mainly focus on the distribution of electronic components. Line cards we deal with include Microchip,ALPS,ROHM,Xilinx,Pulse,ON,Everlight and Freescale. Main products comprise IC,Modules,Potentiometer,IC Socket,Relay,Connector.Our parts cover such applications as commercial,industrial, and automotives areas.

We are looking forward to setting up business relationship with you and hope to provide you with the best service and solution. Let us make a better world for our industry!



Contact us

Tel: +86-755-8981 8866 Fax: +86-755-8427 6832

Email & Skype: info@chipsmall.com Web: www.chipsmall.com

Address: A1208, Overseas Decoration Building, #122 Zhenhua RD., Futian, Shenzhen, China



EVALUATION KIT
AVAILABLE

1mm x 1mm Video Filter Amplifier with Automatic Shutdown and 2V/V Gain

General Description

Packaged in a 1mm x 1mm UCSP™ with 4 bumps, the MAX9515 is an ultra-small standard-definition video filter amplifier with automatic shutdown.

The automatic shutdown circuitry eliminates the need for a shutdown control. This feature provides intelligent power management by disabling the filter and output amplifier in the absence of a video input signal and/or an output video load. At shutdown, the device only consumes 5µA.

The MAX9515 features an internal reconstruction filter that smoothes the steps and reduces the spikes on the video signal from the video digital-to-analog converter (DAC). The reconstruction filter typically has ±1dB passband flatness to 9MHz and typically 50dB of attenuation at 27MHz.

The video input to the MAX9515 can be directly connected to the DAC output. The MAX9515 has an internal fixed gain of 2V/V and expects a nominal full-scale video input signal of 1V_{p-p}. The MAX9515 is specified to operate over the -40°C to +125°C automotive temperature range.

Applications

Digital Still Cameras (DSC)
Mobile Phones
Digital Video Camcorders (DVC)
Portable or Space-Constrained Applications

UCSP is a trademark of Maxim Integrated Products, Inc.

Features

- ◆ Ultra-Small, 4-Bump, 1mm x 1mm UCSP
- ◆ Automatic Shutdown
- ◆ DC-Coupled Input and Output
- ◆ 2.7V to 3.6V Single-Supply Operation
- ◆ Reconstruction Filter with 9MHz Passband and 50dB Attenuation at 27MHz
- ◆ 5µA Shutdown Supply Current

Ordering Information

PART	PIN-PACKAGE	TOP MARK	PKG CODE
MAX9515ABS+T	4 UCSP	AFW	B4+1

Note: This device is specified over the -40°C to +125°C operating temperature range.

+Denotes a lead-free/RoHS-compliant package.

T = Tape and reel.

Pin Configuration

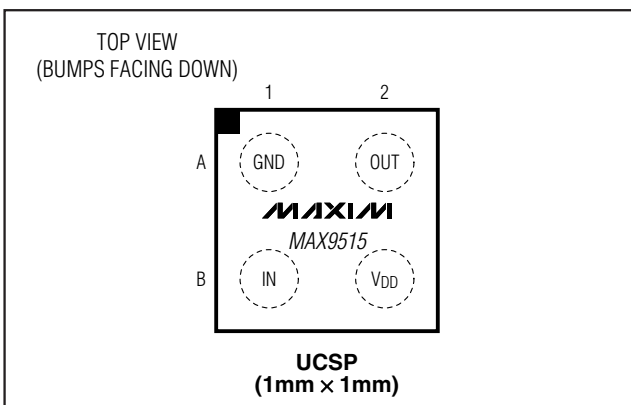

Block Diagram

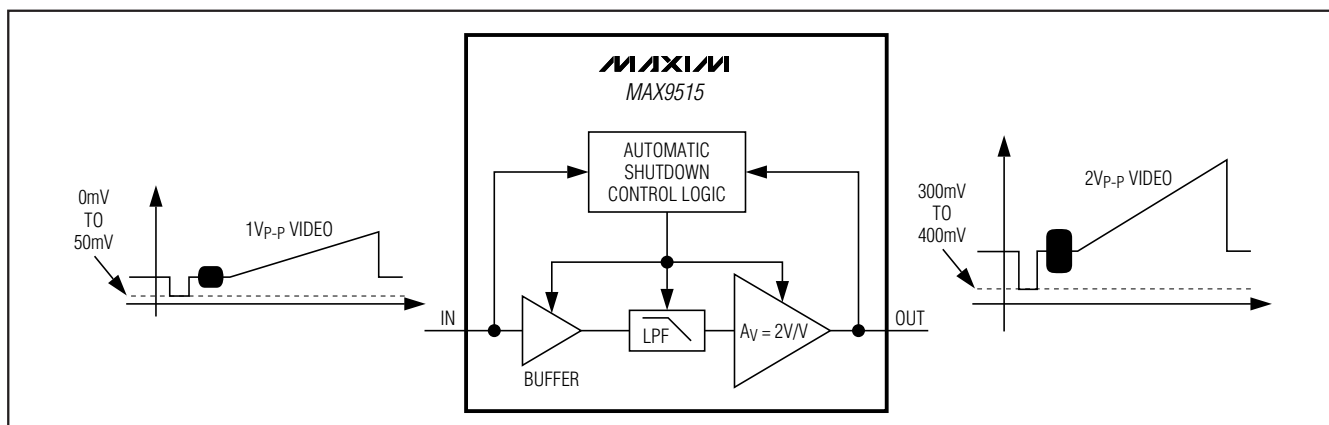

1mm x 1mm Video Filter Amplifier with Automatic Shutdown and 2V/V Gain

ABSOLUTE MAXIMUM RATINGS

(Voltages with respect to GND.)

V _{DD}	0 to +4V
IN	-0.3V to +4V
OUT (during shutdown)	-0.3V to +1.5V
Continuous Current	
IN	±20mA
Continuous Power Dissipation (T _A = +70°C)	
4-Bump UCSP (derate 3mW/°C above +70°C).....	239mW

Maximum Output Current

OUT	±100mA
Operating Temperature Range	-40°C to +125°C
Junction Temperature	+150°C
Storage Temperature Range	-65°C to +150°C
Bump Temperature (soldering)	
Infrared (15s)	+220°C
Vapor Phase (60s)	+215°C

Stresses beyond those listed under "Absolute Maximum Ratings" may cause permanent damage to the device. These are stress ratings only, and functional operation of the device at these or any other conditions beyond those indicated in the operational sections of the specifications is not implied. Exposure to absolute maximum rating conditions for extended periods may affect device reliability.

ELECTRICAL CHARACTERISTICS

(V_{DD} = 3.3V, video output has R_L = 150Ω connected to GND, T_A = T_{MIN} to T_{MAX}, unless otherwise noted. Typical values are at T_A = +25°C.) (Note 1)

PARAMETER	SYMBOL	CONDITIONS		MIN	TYP	MAX	UNITS
Supply Voltage Range	V _{DD}	Guaranteed by PSRR test		2.7	3.3	3.6	V
Supply Current	I _{DD}	Automatic shutdown mode	No load, IN does not have an active video signal		5	10	μA
		Active-detect mode	No load, IN has a black-burst video signal with a sync tip		9	20	
		R _L = 150Ω connected to GND, IN has a black-burst video signal with a sync tip, quiescent current only; no load current is included			2.9	4.8	mA
AUTOMATIC SHUTDOWN							
Minimum Line Frequency				7.3			kHz
Sync Slice Level				4.1		5.2	%V _{DD}
Output Load Detect Threshold						200	Ω
DC CHARACTERISTICS							
Input Voltage Range		Guaranteed by output-voltage swing	2.7V ≤ V _{DD} ≤ 3.6V	0		1.05	V
			3.0V ≤ V _{DD} ≤ 3.6V	0		1.20	
Input Current	I _B	IN = GND			2	5	μA
Input Resistance	R _{IN}				17		MΩ
DC Voltage Gain (Note 2)	A _V	Guaranteed by output-voltage swing		1.96	2.00	2.04	V/V
Output Level		IN = GND		0.21	0.30	0.41	V
Output-Voltage Swing		Measured at output	2.7V ≤ V _{DD} ≤ 3.6V, 0 ≤ V _{IN} ≤ 1.05V	2.058	2.1	2.121	V _{P-P}
			3.0V ≤ V _{DD} ≤ 3.6V, 0 ≤ V _{IN} ≤ 1.20V	2.352	2.4	2.424	

1mm x 1mm Video Filter Amplifier with Automatic Shutdown and 2V/V Gain

MAX9515

ELECTRICAL CHARACTERISTICS (continued)

($V_{DD} = 3.3V$, video output has $R_L = 150\Omega$ connected to GND, $T_A = T_{MIN}$ to T_{MAX} , unless otherwise noted. Typical values are at $T_A = +25^\circ C$.) (Note 1)

PARAMETER	SYMBOL	CONDITIONS	MIN	TYP	MAX	UNITS
Output Resistance	R_{OUT}	$V_{OUT} = 1.3V, -5mA \leq I_{LOAD} \leq +5mA$		0.47		Ω
Output Leakage Current		IN does not have active video signal, $V_{OUT} = 1.5V$			1	μA
Power-Supply Rejection Ratio	PSRR	$2.7V \leq V_{DD} \leq 3.6V, V_{IN} = 1.05V$	48			dB
AC CHARACTERISTICS						
Standard-Definition Reconstruction Filter		$\pm 1dB$ passband flatness		9		MHz
		$V_{IN} = 1V_{P-P}$, reference frequency is 1MHz	$f = 5.5MHz$	0		dB
			$f = 9.6MHz$	-3		
			$f = 27MHz$	-50		
Differential Gain	DG	$f = 3.58MHz$		0.2		%
		$f = 4.43MHz$		0.25		
Differential Phase	DP	$f = 3.58MHz$		0.35		Degrees
		$f = 4.43MHz$		0.45		
Group-Delay Distortion		$100kHz \leq f \leq 5MHz, V_{OUT} = 2V_{P-P}$		9.84		ns
Peak Signal-to-RMS Noise		$100kHz \leq f \leq 5MHz$		-71.8		dB _{RMS}
Power-Supply Rejection Ratio	PSRR	$f = 100kHz, 200mV_{P-P}$		42		dB
2T Pulse Response		$2T = 200ns$		0.2		K%
2T Pulse-to-Bar K Rating		$2T = 200ns$, bar time is $18\mu s$; the beginning 2.5% and the ending 2.5% of the bar time is ignored		0.2		K%
2T Bar Response		$2T = 200ns$, bar time is $18\mu s$; the beginning 2.5% and the ending 2.5% of the bar time is ignored		0.2		K%
Nonlinearity		5-step staircase		0.3		%
Output Impedance		$f = 5MHz$		6		Ω

Note 1: All devices are 100% production tested at $T_A = +25^\circ C$. Specifications over temperature limits are guaranteed by design.

Note 2: Voltage gain (A_V) is a two-point measurement in which the output-voltage swing is divided by the input-voltage swing.

1mm x 1mm Video Filter Amplifier with Automatic Shutdown and 2V/V Gain

Typical Operating Characteristics

($V_{DD} = 3.3V$, $GND = 0V$, DC-coupled input, video output has $R_L = 150\Omega$ connected to GND , $T_A = +25^\circ C$, unless otherwise noted.)

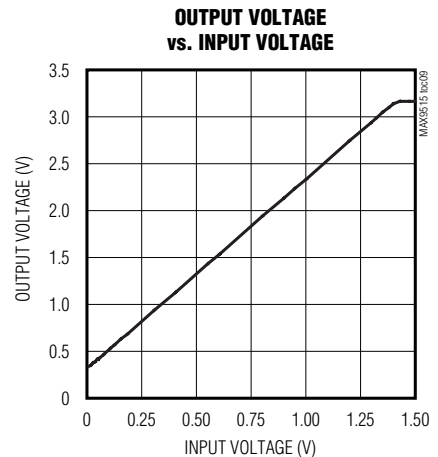
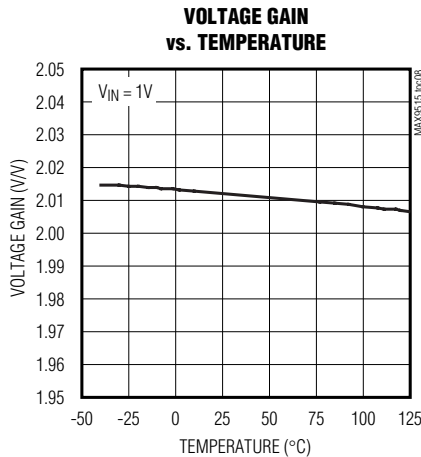
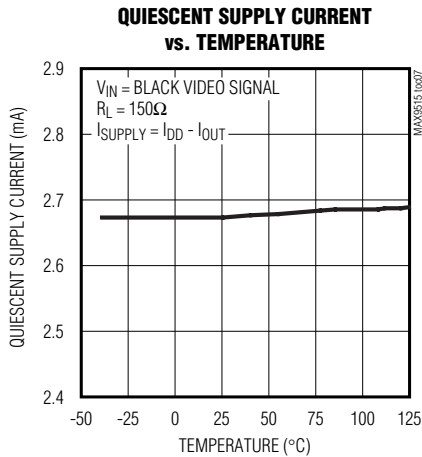
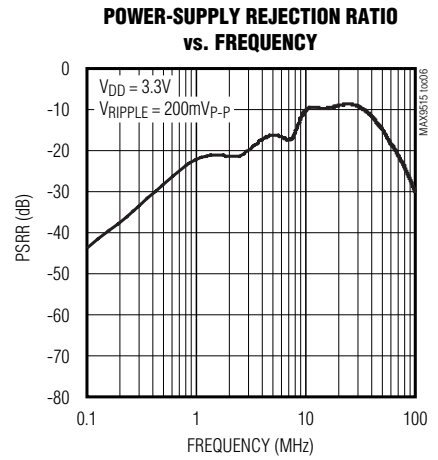
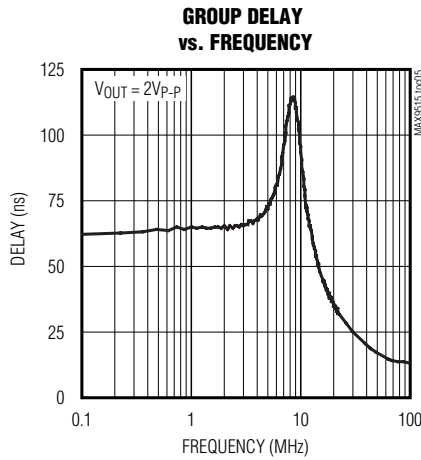
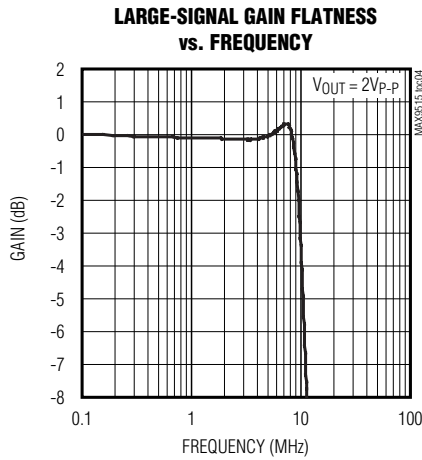
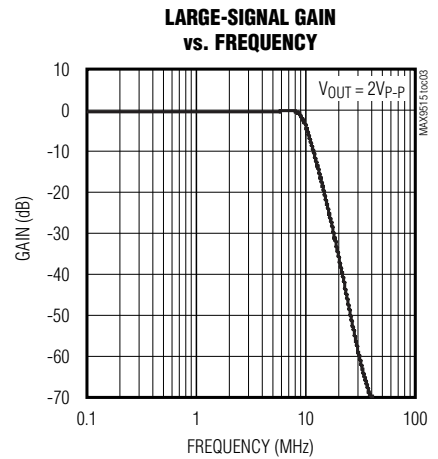
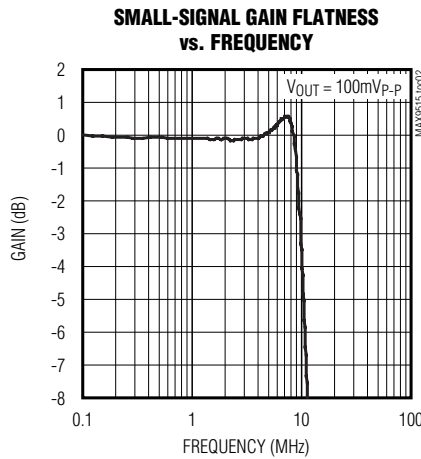
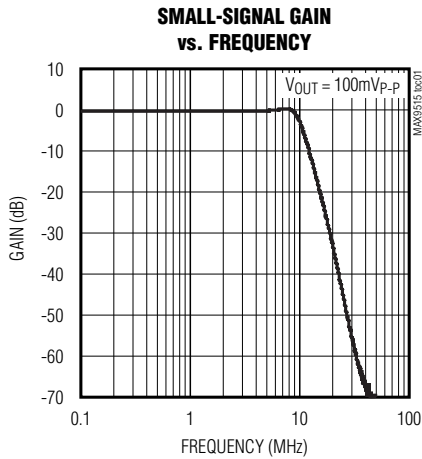

1mm x 1mm Video Filter Amplifier with Automatic Shutdown and 2V/V Gain

Typical Operating Characteristics (continued)

($V_{DD} = 3.3V$, $GND = 0V$, DC-coupled input, video output has $R_L = 150\Omega$ connected to GND , $T_A = +25^\circ C$, unless otherwise noted.)

MAX9515

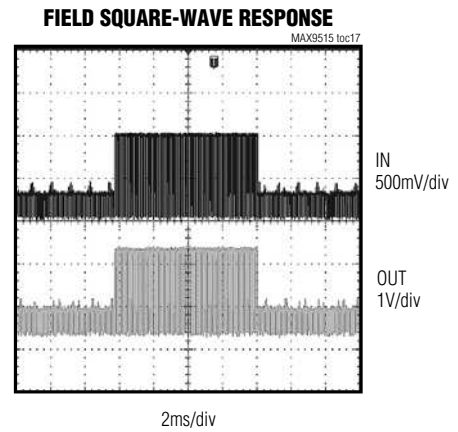
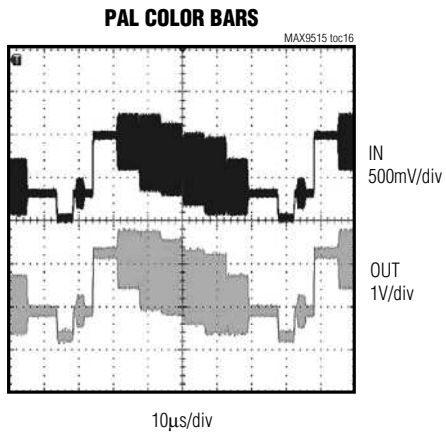
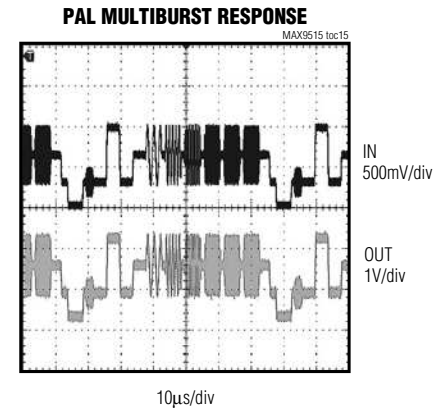
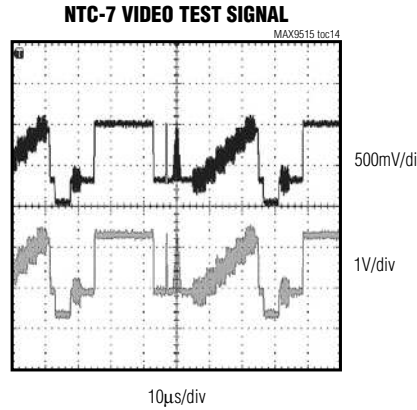
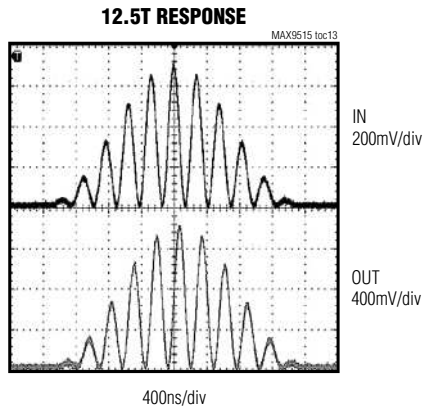
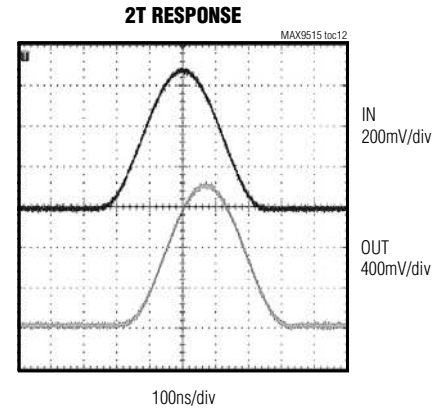
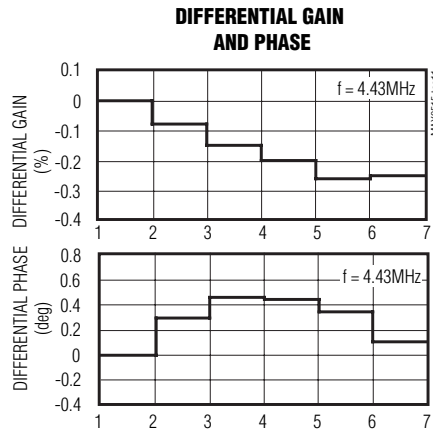
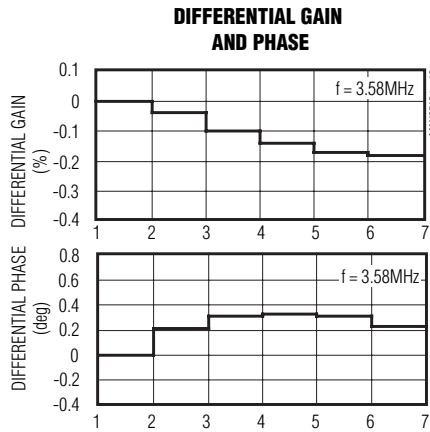

1mm x 1mm Video Filter Amplifier with Automatic Shutdown and 2V/V Gain

Pin Description

PIN	NAME	FUNCTION
A1	GND	Ground
A2	OUT	Video Output
B1	IN	Video Input
B2	VDD	Positive Power Supply. Bypass VDD with a 0.1µF capacitor to ground.

Detailed Description

The MAX9515 is an ultra-small, standard-definition video filter amplifier with automatic shutdown. Automatic shutdown circuitry provides intelligent power management by disabling the filter and output amplifier in the absence of an input video signal and/or output load.

An internal reconstruction filter smooths the steps and reduces the spikes on the video signal from the video digital-to-analog converter. The reconstruction filter typically has ± 1 dB passband flatness to 9MHz and typically 50dB of attenuation at 27MHz. The MAX9515 has an internal fixed gain of 2V/V and expects a nominal full-scale video input signal of 1V_{p-p}.

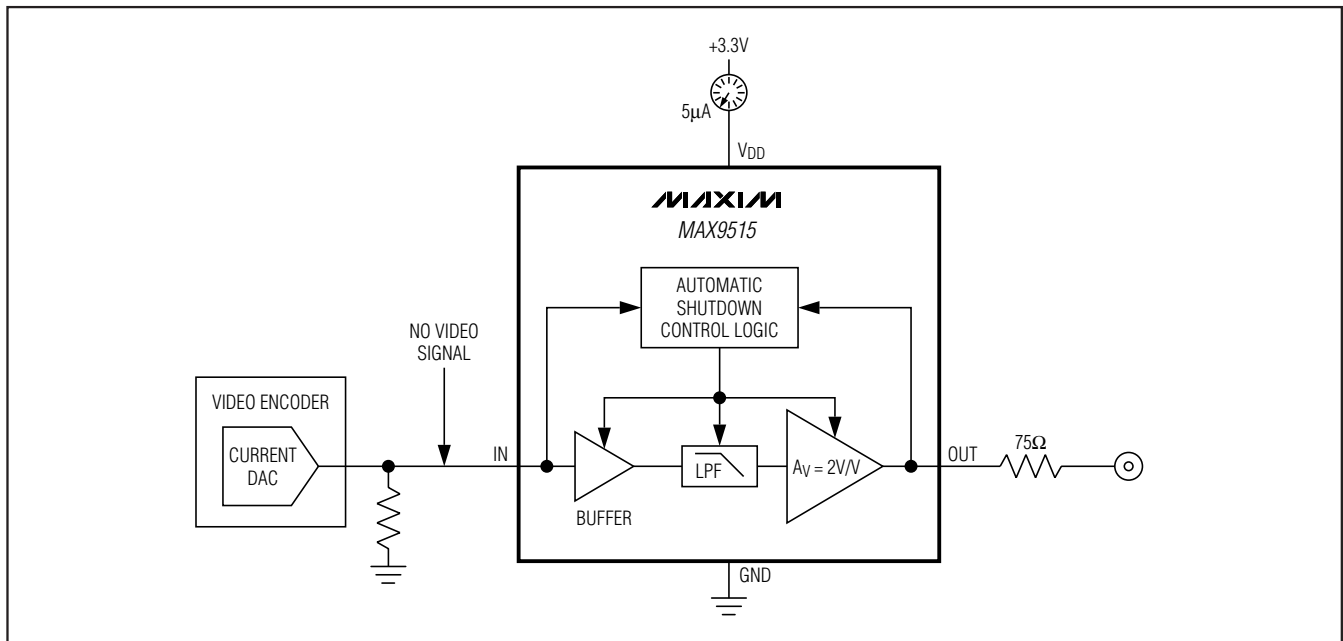

Figure 1. Automatic Shutdown

1mm x 1mm Video Filter Amplifier with Automatic Shutdown and 2V/V Gain

Automatic Shutdown

The MAX9515 automatic shutdown circuitry reduces power consumption when there is no active video input signal or an output load. In shutdown, the supply current is reduced to 5 μ A. The video amplifier only turns on when both an active video input signal and an output load are present.

The MAX9515 slices the IN signal at 4.7% of the power supply (155mV for a 3.3V supply). If the transitions occur at a rate of 7.3kHz or higher, a video signal is present. When the MAX9515 detects a video signal with sync at the input, the control logic enters the active-detect mode and enables the load sense circuitry (Figure 2). The supply current increases from 5 μ A to 9 μ A typically.

If an output load is not connected to the amplifier, the MAX9515 remains in active-detect mode. Eight times per second, the load-sense circuit checks for a load by

connecting an internal 15k Ω pullup resistor to the output for 1ms. If the output is pulled up, no load is present. If the output stays low, a load is connected.

If the input video signal is present and a load is connected to the output, the filter and amplifier turn on and remain on until the output load is disconnected. Automatic shutdown intelligently reduces the supply current based on the input signal presence and output loading (Figure 3).

When the amplifier is on, it continually checks if the load has been disconnected by detecting if the amplifier output is sourcing current during a horizontal line time. If no sourcing current is detected within one horizontal line time (approximately 64 μ s), the load has been disconnected and the amplifier returns to active-detect mode. If, at any time, the input video signal is removed, the MAX9515 returns to standby mode.

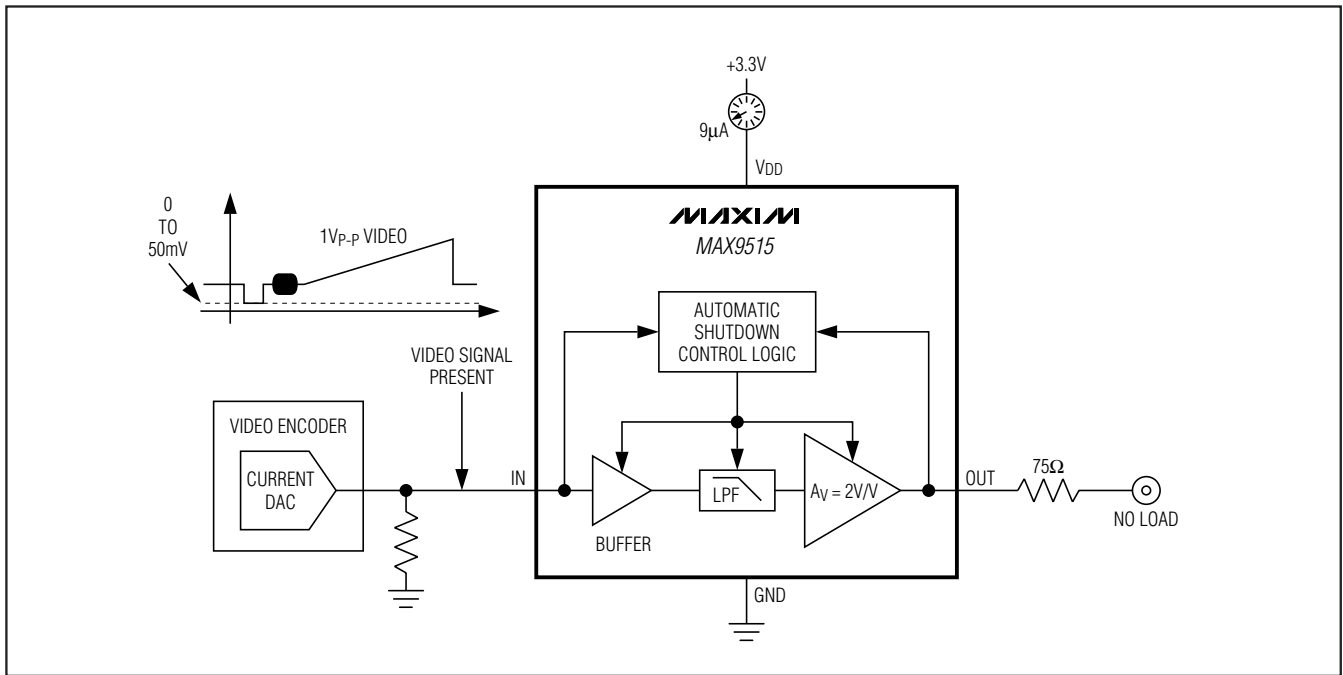

Figure 2. Active-Detect Mode

1mm x 1mm Video Filter Amplifier with Automatic Shutdown and 2V/V Gain

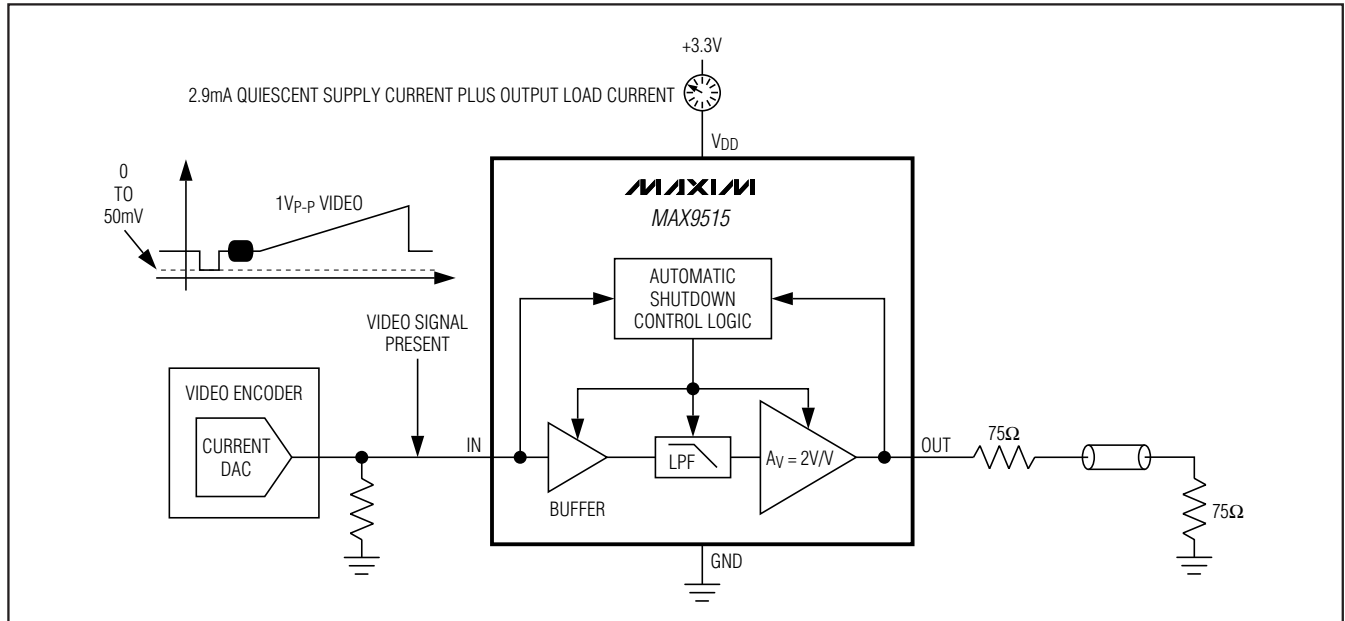

Figure 3. Full-Operation Mode

Input

The MAX9515 video input should be directly connected to the output of the video current DAC. DC-coupling ensures that the input signal is ground referenced such that the sync tip of the composite video signal is within 50mV of ground. Any standard-definition video signal can be applied to the input as long as the signal is between ground and 1.05V when $V_{DD} = 2.7V$.

Video Reconstruction Filter

The filter passband ($\pm 1dB$) is typically 9MHz, which makes the device suitable for standard-definition video signals from all sources (e.g., broadcast and DVD). Broadcast video signals are channel limited: NTSC signals have 4.2MHz bandwidth, and PAL signals have 5MHz of bandwidth. Video signals from a DVD player, however, are not channel limited; so the bandwidth of DVD video signals approaches the Nyquist limit of 6.75MHz. (Recommendation ITU-R BT.601-5 specifies 13.5MHz as the sampling rate for standard-definition video). Therefore, the maximum bandwidth of the signal is 6.75MHz. To ease the filtering requirements, most modern video systems over sample by two times, clocking the video current DAC at 27MHz.

Output

The MAX9515 output expects to drive a DC-coupled load to ground. The amplifier output stage needs about 300mV of headroom from either supply rail. The device has an internal level shift circuit that positions the sync tip at approximately 300mV at the output.

Applications Information

Power-Supply Bypassing and Ground

The MAX9515 operates from a single-supply voltage down to 2.7V, allowing for low-power operation. Bypass V_{DD} to GND with a 0.1 μF capacitor. Place all external components as close as possible to the device.

UCSP Applications Information

For the latest application details on UCSP construction, dimensions, tape carrier information, PCB techniques, bump-pad layout, and recommended reflow temperature profile, as well as the latest information on reliability testing results, go to the Maxim's website at www.maxim-ic.com/ucsp to find the Application Note 1891: *Understanding the Basics of the Wafer-Level Chip-Scale Package (WL-CSP)*.

Chip Information

PROCESS: BiCMOS

1mm x 1mm Video Filter Amplifier with Automatic Shutdown and 2V/V Gain

Package Information

For the latest package outline information and land patterns, go to www.maxim-ic.com/packages.

MAX9515

TOP VIEW

COMMON DIMENSIONS	
A	0.62±0.05-0.08
A1	0.29±0.02
A2	0.33 REF.
b	∅0.35±0.03
D1	0.50 BASIC
E1	0.50 BASIC
e	0.50 BASIC
SD	0.25 BASIC
SE	0.25 BASIC

PKG. CODE	VARIABLE DIMENSIONS		DEPOPULATED SOLDER BALLS
	D	E	
B4-1	1.00±0.05	1.00±0.05	NONE
B4-2	1.05±0.05	1.05±0.05	NONE
B4-3	1.10±0.05	1.10±0.05	NONE
B4-4	0.97±0.05	0.97±0.05	NONE

NOTES:

- ALL DIMENSIONS ARE IN MILLIMETERS.
- PRODUCT MARKING: NUMBER OF CHARACTERS AND LINES VARY PER PRODUCT.

BOTTOM VIEW

SIDE VIEW

DALLAS SEMICONDUCTOR		MAXIM	
PROPRIETARY INFORMATION			
TITLE: PACKAGE OUTLINE, 2x2 UCSP			
APPROVAL	DOCUMENT CONTROL NO. 21-0117	REV. G	1/1

4L UCSP 2x2.EPS

PACKAGE TYPE	PACKAGE CODE	DOCUMENT NO.
4 UCSP	B4+1	21-0117

1mm x 1mm Video Filter Amplifier with Automatic Shutdown and 2V/V Gain

Revision History

REVISION NUMBER	REVISION DATE	DESCRIPTION	PAGES CHANGED
0	5/08	Initial release	—
1	8/08	Updated EC table	3

Maxim cannot assume responsibility for use of any circuitry other than circuitry entirely embodied in a Maxim product. No circuit patent licenses are implied. Maxim reserves the right to change the circuitry and specifications without notice at any time.

10 **Maxim Integrated Products, 120 San Gabriel Drive, Sunnyvale, CA 94086 408-737-7600**