



Chipsmall Limited consists of a professional team with an average of over 10 year of expertise in the distribution of electronic components. Based in Hongkong, we have already established firm and mutual-benefit business relationships with customers from,Europe,America and south Asia,supplying obsolete and hard-to-find components to meet their specific needs.

With the principle of “Quality Parts,Customers Priority,Honest Operation,and Considerate Service”,our business mainly focus on the distribution of electronic components. Line cards we deal with include Microchip,ALPS,ROHM,Xilinx,Pulse,ON,Everlight and Freescale. Main products comprise IC,Modules,Potentiometer,IC Socket,Relay,Connector.Our parts cover such applications as commercial,industrial, and automotives areas.

We are looking forward to setting up business relationship with you and hope to provide you with the best service and solution. Let us make a better world for our industry!



## Contact us

Tel: +86-755-8981 8866 Fax: +86-755-8427 6832

Email & Skype: info@chipsmall.com Web: www.chipsmall.com

Address: A1208, Overseas Decoration Building, #122 Zhenhua RD., Futian, Shenzhen, China





# Single/Dual/Quad, Micropower, Ultra-Low-Voltage, Rail-to-Rail I/O Comparators

## General Description

The MAX965–MAX970 single/dual/quad micropower comparators feature rail-to-rail inputs and outputs, and fully specified single-supply operation down to +1.6V. These devices draw less than 5 $\mu$ A per comparator and have open-drain outputs that can be pulled beyond  $V_{CC}$  to 6V (max) above ground. In addition, their rail-to-rail input common-mode voltage range makes these comparators suitable for ultra-low-voltage operation.

A +1.6V to +5.5V single-supply operating voltage range makes the MAX965 family of comparators ideal for 2-cell battery-powered applications. The MAX965/MAX967/MAX968/MAX969 offer programmable hysteresis and an internal 1.235V  $\pm$ 1.5% reference. All devices are available in either space-saving 8-pin  $\mu$ MAX<sup>®</sup> or 16-pin QSOP packages.

## Applications

2-Cell Battery-Powered/Portable Systems  
Window Comparators  
Threshold Detectors/Discriminators  
Mobile Communications  
Voltage-Level Translation  
Ground/Supply-Sensing Applications

## Selector Guide

PART	INTERNAL REFERENCE	COMPARATORS PER PACKAGE	PROGRAMMABLE HYSTERESIS
MAX965	Yes	1	Yes
MAX966	No	2	No
MAX967	Yes	2	Yes
MAX968	Yes	2	Yes
MAX969	Yes	4	Yes
MAX970	No	4	No

## Features

- ◆ Ultra-Low Single-Supply Operation down to +1.6V
- ◆ Rail-to-Rail Common-Mode Input Voltage Range
- ◆ 3 $\mu$ A Quiescent Supply Current per Comparator
- ◆ Open-Drain Outputs Swing Beyond  $V_{CC}$
- ◆ 1.235V  $\pm$ 1.5% Precision Internal Reference (MAX965/967/968/969)
- ◆ 10 $\mu$ s Propagation Delay (50mV overdrive)
- ◆ Available in Space-Saving Packages:
  - 8-Pin  $\mu$ MAX (MAX965–MAX968)
  - 16-Pin QSOP (MAX969/MAX970)

## Ordering Information

PART	TEMP RANGE	PIN-PACKAGE	PKG CODE
MAX965ESA	-40°C to +85°C	8 SO	S8-2
MAX965EUA-T	-40°C to +85°C	8 $\mu$ MAX-8	U8-1
MAX966ESA	-40°C to +85°C	8 SO	S8-2
MAX966EUA-T	-40°C to +85°C	8 $\mu$ MAX-8	U8-1
MAX967ESA	-40°C to +85°C	8 SO	S8-2
MAX967EUA-T	-40°C to +85°C	8 $\mu$ MAX-8	U8-1

Ordering Information continued on last page.

Pin Configurations appear at end of data sheet.

$\mu$ MAX is a registered trademark of Maxim Integrated Products, Inc.

## Typical Operating Circuit

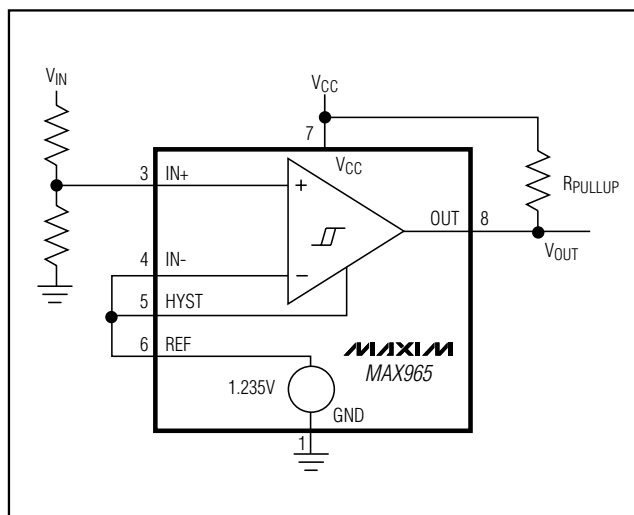

# Single/Dual/Quad, Micropower, Ultra-Low-Voltage, Rail-to-Rail I/O Comparators

## ABSOLUTE MAXIMUM RATINGS

Supply Voltage ( $V_{CC}$ )	+6V	8-Pin $\mu$ MAX (derate 4.10mW/°C above +70°C)	330mW
Voltages		14-Pin SO (derate 8.33mW/°C above +70°C)	667mW
IN <sub>-</sub> , IN <sub>+</sub> , REF, HYST	-0.3V to ( $V_{CC} + 0.3V$ )	16-Pin SO (derate 8.70mW/°C above +70°C)	696mW
OUT <sub>-</sub>	-0.3V to +6.0V	16-Pin QSOP (derate 5.70mW/°C above +70°C)	457mW
Current into Input Pins	$\pm 20$ mA	Operating Temperature Range	-40°C to +85°C
Duration of OUT <sub>-</sub> Short Circuit to GND or $V_{CC}$	Continuous	Storage Temperature Range	-65°C to +150°C
Continuous Power Dissipation		Lead Temperature (soldering, 10s)	+300°C
8-Pin SO (derate 5.88mW/°C above +70°C)	471mW		

Stresses beyond those listed under "Absolute Maximum Ratings" may cause permanent damage to the device. These are stress ratings only, and functional operation of the device at these or any other conditions beyond those indicated in the operational sections of the specifications is not implied. Exposure to absolute maximum rating conditions for extended periods may affect device reliability.

## ELECTRICAL CHARACTERISTICS

( $V_{CC} = +1.6V$  to  $+5.5V$ ,  $T_A = T_{MIN}$  to  $T_{MAX}$ , unless otherwise noted. Typical values are at  $V_{CC} = 3V$  and  $T_A = +25^\circ C$ .)

PARAMETER	SYMBOL	CONDITIONS	MIN	TYP	MAX	UNITS
<b>POWER SUPPLIES</b>						
Supply Voltage Range	$V_{CC}$	All packages, $T_A = 0^\circ C$ to $+85^\circ C$	1.6		5.5	V
		SO/QSOP packages, $T_A = -40^\circ C$ to $+85^\circ C$	1.7		5.5	
		$\mu$ MAX package, $T_A = -40^\circ C$ to $+85^\circ C$	1.8		5.5	
Comparator Minimum Operating Voltage				1.0		V
Supply Current	$I_{CC}$	MAX965		7.0	12	$\mu A$
		MAX966		6.0	10	
		MAX967/MAX968		10	16	
		MAX969		14	22	
		MAX970		11	18	
Power-Up Time ( $V_{CC}$ to output valid)		$V_{CC}$ stepped 0V to 5V		20		$\mu s$
<b>COMPARATOR</b>						
Power-Supply Rejection Ratio	PSRR	$1.7V \leq V_{CC} \leq 5.5V$		0.1	1.0	mV/V
Common-Mode Voltage Range	$V_{CMR}$	$T_A = +25^\circ C$	-0.25		$V_{CC}$	V
		$T_A = -40^\circ C$ to $+85^\circ C$	-0.25		$V_{CC} - 0.25$	V
Input Offset Voltage	$V_{OS}$	Common-mode range = -0.25V to 1.3V, $V_{CC} > 1.8V$	SO package		3.0	mV
			QSOP package		4.0	
			$\mu$ MAX package	0°C to +85°C	4.0	
				-40°C to +85°C	6.0	
		Full common-mode range	SO package		7.0	
			QSOP package		10.0	
$\mu$ MAX package	0°C to +85°C	10.0				
	-40°C to +85°C	15.0				
Input Hysteresis	$V_{HYST}$	HYST = REF		$\pm 1$		mV
Input Bias Current	$I_B$	Common-mode range = -0.25V to ( $V_{CC} - 0.25V$ )	0.001		$\pm 5$	nA
		Full common-mode range, $T_A = +25^\circ C$	0.001		$\pm 50$	
Input Offset Current	$I_{OS}$			0.2		pA
Input Capacitance	$C_{IN}$			7.0		pF

# Single/Dual/Quad, Micropower, Ultra-Low-Voltage, Rail-to-Rail I/O Comparators

MAX965-MAX970

## ELECTRICAL CHARACTERISTICS (continued)

( $V_{CC} = +1.6V$  to  $+5.5V$ ,  $T_A = T_{MIN}$  to  $T_{MAX}$ , unless otherwise noted. Typical values are at  $V_{CC} = 3V$  and  $T_A = +25^\circ C$ .)

PARAMETER	SYMBOL	CONDITIONS		MIN	TYP	MAX	UNITS
Common-Mode Rejection Ratio	CMRR				1.5	4.0	mV/V
HYST Input Voltage Range				$V_{REF} - 0.05$		$V_{REF}$	V
HYST Input Leakage	$I_{HYST}$					$\pm 10$	nA
Hysteresis Gain					1.0		V/V
Input Voltage Noise	$e_n$	$f = 100Hz$ to $100kHz$ , $C_{REF} = 1000pF$			10		$\mu V_{RMS}$
OUT Output Voltage Low	$V_{OL}$	$I_{OUT} = 100\mu A$ , $1.6V < V_{CC} < 2.7V$				0.2	V
		$I_{OUT} = 500\mu A$ , $2.7V < V_{CC} < 5.5V$				0.4	
OUT Output Leakage Current	$I_{LEAK}$	$V_{CC} = 5.5V$ , $V_{OUT} = 5.5V$			1	100	nA
		$V_{CC} = 1.6V$ , $V_{OUT} = 1.6V$					
Propagation Delay	$t_{PD}$	$R_{PULLUP} = 1M\Omega$ , $C_{LOAD} = 15pF$ , high to low	10mV overdrive		20		$\mu s$
			50mV overdrive		10		
<b>REFERENCE</b>							
Reference Voltage	$V_{REF}$	SO package		1.125	1.235	1.255	V
		QSOP package		1.205	1.235	1.265	
		$\mu MAX$ package, $T_A = 0^\circ C$ to $+85^\circ C$		1.205	1.235	1.265	
		$\mu MAX$ package, $T_A = -40^\circ C$ to $+85^\circ C$		1.185	1.235	1.285	
Source Current	$I_{REF+}$	HYST = REF		15	50		$\mu A$
Sink Current	$I_{REF-}$			200	400		nA
Output Voltage Noise		$f = 100Hz$ to $100kHz$ , $C_{REF} = 0.1\mu F$			10		$\mu V_{RMS}$

## Typical Operating Characteristics

( $V_{CC} = +3.0V$ ,  $R_{PULLUP} = 100k\Omega$ ,  $V_{CM} = 0V$ ,  $T_A = +25^\circ C$ , unless otherwise noted.)

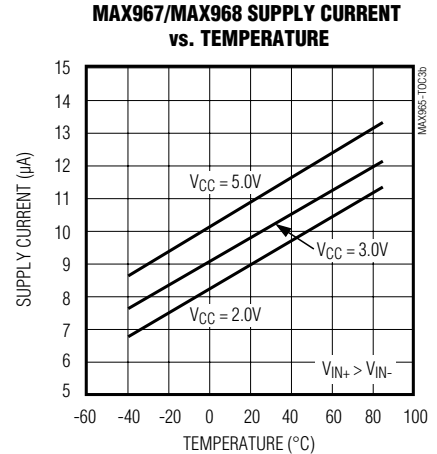
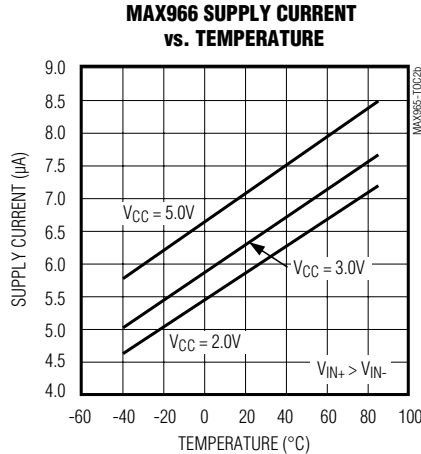
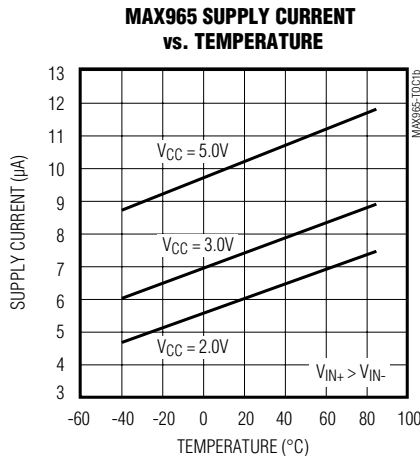

# Single/Dual/Quad, Micropower, Ultra-Low-Voltage, Rail-to-Rail I/O Comparators

## Typical Operating Characteristics (continued)

( $V_{CC} = +3.0V$ ,  $R_{PULLUP} = 100k\Omega$ ,  $V_{CM} = 0V$ ,  $T_A = +25^\circ C$ , unless otherwise noted.)

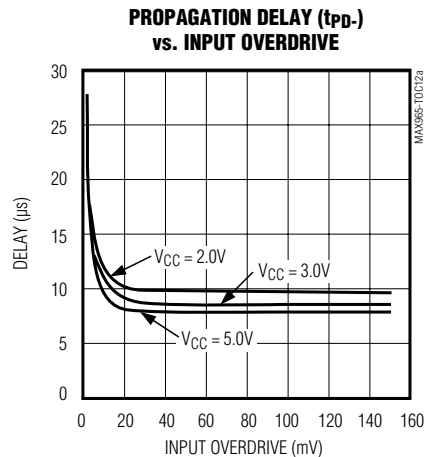
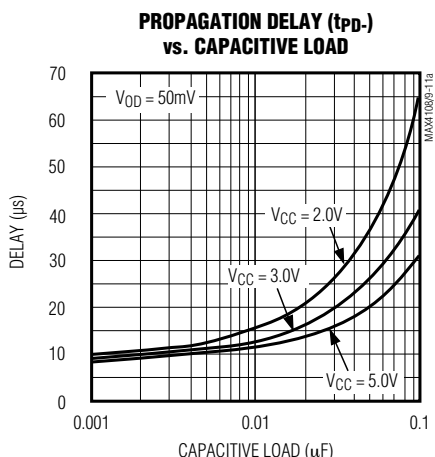
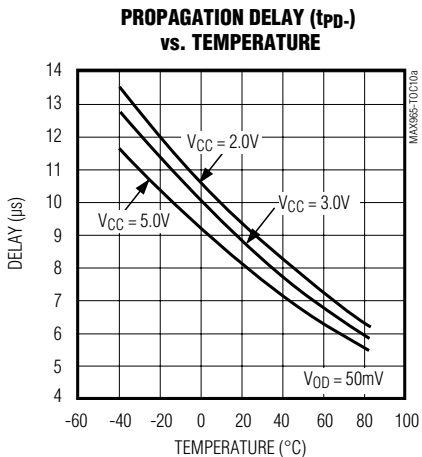
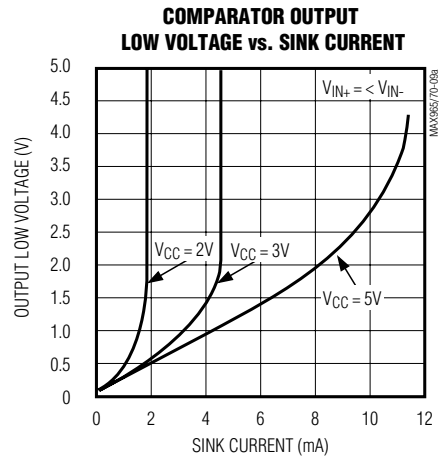
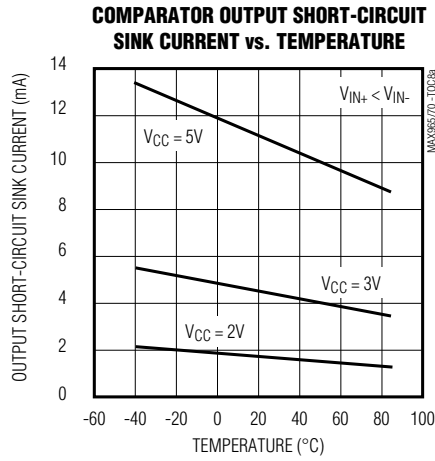
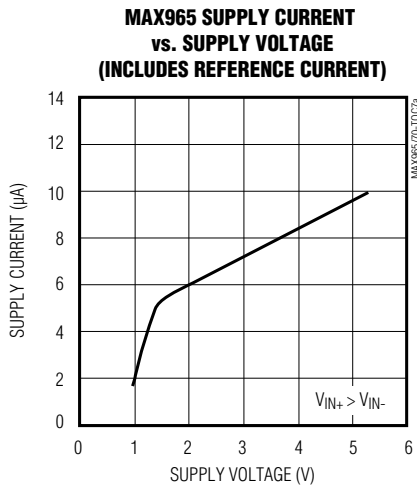
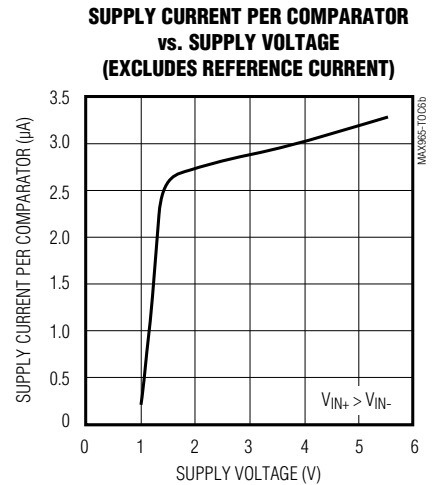
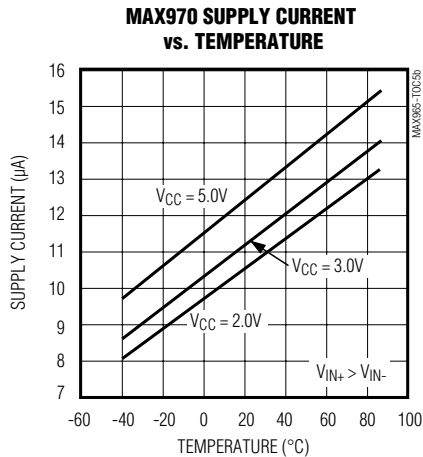
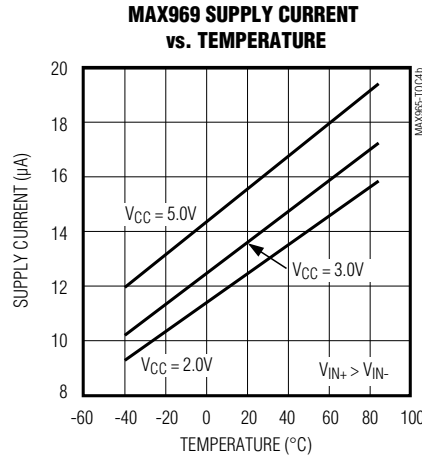

# Single/Dual/Quad, Micropower, Ultra-Low-Voltage, Rail-to-Rail I/O Comparators

## Typical Operating Characteristics (continued)

( $V_{CC} = +3.0V$ ,  $R_{PULLUP} = 100k\Omega$ ,  $V_{CM} = 0V$ ,  $T_A = +25^\circ C$ , unless otherwise noted.)

MAX965-MAX970

**SUPPLY CURRENT PER COMPARATOR vs. OUTPUT TRANSITION FREQUENCY**

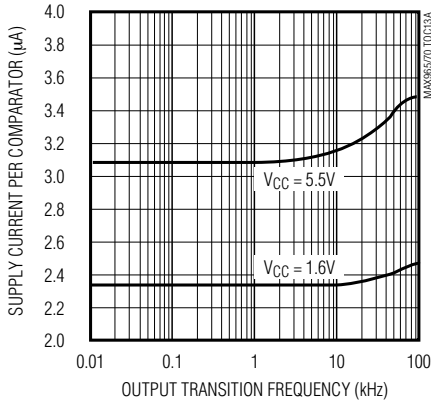

**INPUT OFFSET VOLTAGE vs. TEMPERATURE**

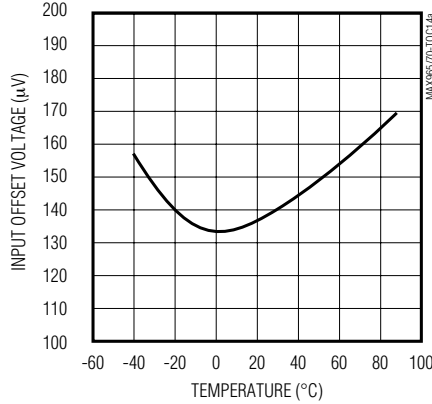

**INPUT BIAS CURRENT vs. TEMPERATURE**

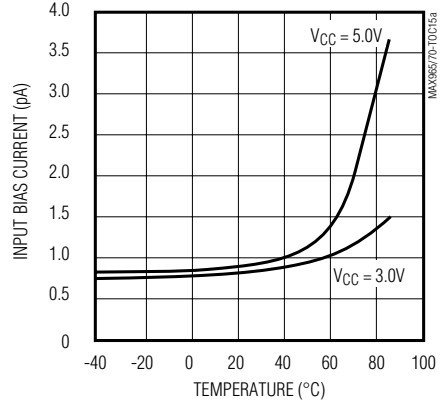

**PROGRAMMED HYSTERESIS vs. COMMON-MODE VOLTAGE**

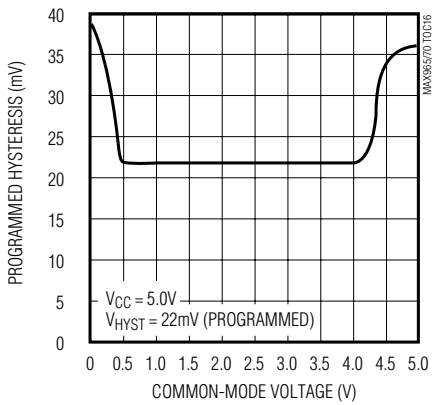

**REFERENCE VOLTAGE vs. TEMPERATURE**

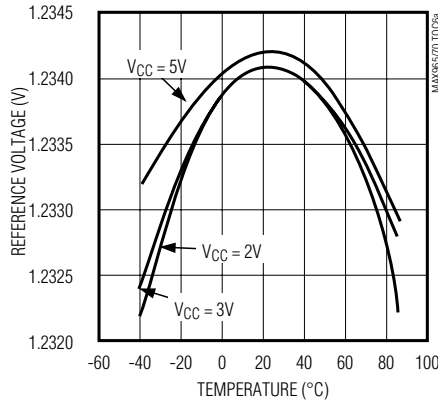

**REFERENCE VOLTAGE vs. SUPPLY VOLTAGE**

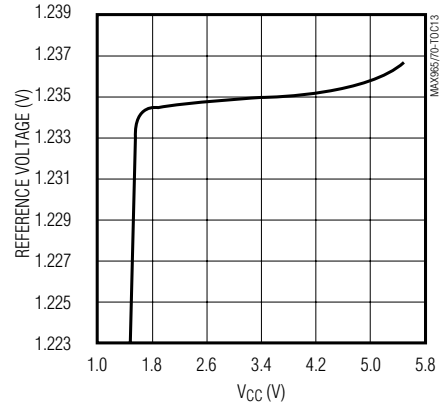

**REFERENCE VOLTAGE vs. SOURCE CURRENT**

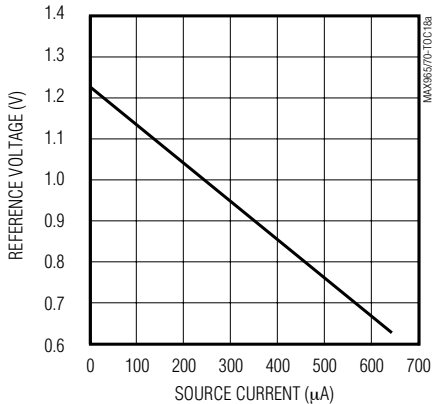

**PROPAGATION DELAY (tpd+) vs. TEMPERATURE**

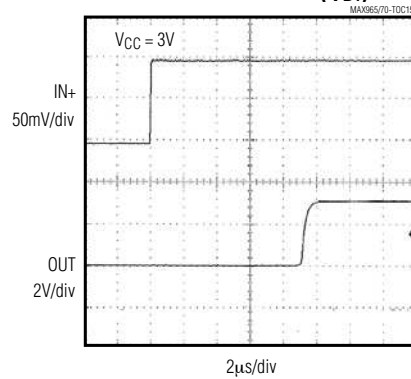

**PROPAGATION DELAY (tpd-) vs. TEMPERATURE**

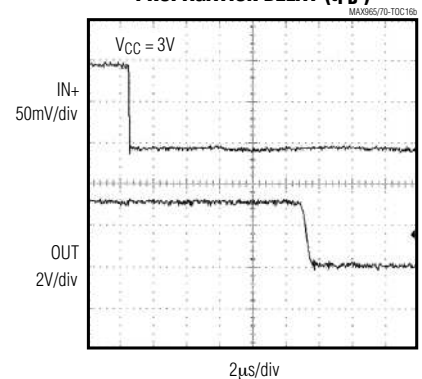

# Single/Dual/Quad, Micropower, Ultra-Low-Voltage, Rail-to-Rail I/O Comparators

## Typical Operating Characteristics (continued)

(V<sub>CC</sub> = +3.0V, R<sub>PULLUP</sub> = 100kΩ, V<sub>CM</sub> = 0V, T<sub>A</sub> = +25°C, unless otherwise noted.)

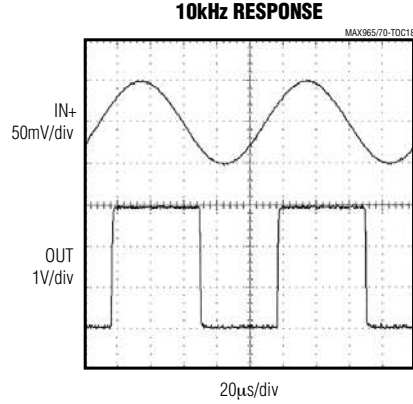
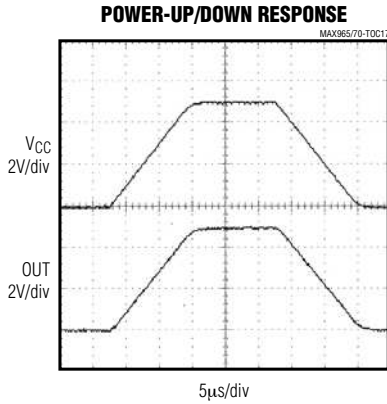

## Pin Descriptions

### MAX965-MAX968

PIN				NAME	FUNCTION
MAX965	MAX966	MAX967	MAX968		
—	1	1	1	OUTA	Comparator A Open-Drain Output
1	2	2	2	GND	Ground
2	—	—	—	N.C.	No Connection. Not internally connected.
3	—	—	—	IN+	Comparator Noninverting Input
—	3	3	3	INA+	Comparator A Noninverting Input
4	—	—	—	IN-	Comparator Inverting Input
—	4	—	—	INA-	Comparator A Inverting Input
—	5	—	4	INB-	Comparator B Inverting Input
—	6	4	—	INB+	Comparator B Noninverting Input
5	—	5	5	HYST	Hysteresis Input. Connect HYST to REF if not used. Input voltage range is from V <sub>REF</sub> to (V <sub>REF</sub> - 50mV).
6	—	6	6	REF	Internal Reference Output. Typically 1.235V with respect to GND.
7	7	7	7	V <sub>CC</sub>	Positive Supply Voltage, +1.6V to +5.5V
8	—	—	—	OUT	Comparator Open-Drain Output
—	8	8	8	OUTB	Comparator B Open-Drain Output

# Single/Dual/Quad, Micropower, Ultra-Low-Voltage, Rail-to-Rail I/O Comparators

MAX965-MAX970

## Pin Descriptions (continued)

### MAX969/MAX970

MAX969	PIN		NAME	FUNCTION
	MAX970			
	SO	QSOP		
1	1	1	OUTB	Comparator B Open-Drain Output
2	2	2	OUTA	Comparator A Open-Drain Output
3	3	3	VCC	Positive Supply Voltage, +1.6V to +5.5V
4	4	4	INA-	Comparator A Inverting Input
5	5	5	INA+	Comparator A Noninverting Input
6	6	6	INB-	Comparator B Inverting Input
7	7	7	INB+	Comparator B Noninverting Input
—	—	8, 9	N.C.	No Connection. Not internally connected.
8	—	—	REF	Internal Reference Output. Typically 1.235V with respect to GND.
9	—	—	HYST	Hysteresis Input. Connect to REF if not used. Input voltage range is from (VREF - 50mV) to VREF.
10	8	10	INC-	Comparator C Inverting Input
11	9	11	INC+	Comparator C Noninverting Input
12	10	12	IND-	Comparator D Inverting Input
13	11	13	IND+	Comparator D Noninverting Input
14	12	14	GND	Ground
15	13	15	OUTD	Comparator D Open-Drain Output
16	14	16	OUTC	Comparator C Open-Drain Output

### Detailed Description

The MAX965–MAX970 single/dual/quad, micropower, ultra-low-voltage comparators feature rail-to-rail inputs and outputs and an internal 1.235V  $\pm$ 1.5% bandgap reference. These devices operate from a single +1.6V to +5.5V supply voltage range, and consume less than 5 $\mu$ A supply current per comparator over the extended temperature range. Internal hysteresis is programmable up to  $\pm$ 50mV using two external resistors and the device's internal reference. The rail-to-rail input common-mode voltage range and the open-drain outputs allow easy voltage-level conversion for multivoltage systems. All inputs and outputs can tolerate a continuous short-circuit fault condition to either rail.

The MAX965 is a single comparator with adjustable hysteresis and a reference output pin. The MAX966 is a dual comparator without the reference and without adjustable hysteresis. The MAX967 is a dual compar-

tor configured as a dual voltage monitor with common hysteresis adjustment and a reference output. The dual MAX968 is similar to the MAX967, but is configured as a window comparator. The MAX969 is a quad comparator with a common hysteresis adjustment and a reference output pin. The MAX970 is a quad comparator without a reference and without hysteresis adjustment. (See *Functional Diagrams* and *Selector Guide*.)

#### Comparator Input

The MAX965–MAX970 have a -0.25V to VCC input common-mode range. Both comparator inputs may operate at any differential voltage within the common-mode voltage range, and the comparator displays the correct output logic state.

#### Low-Voltage Operation: VCC Down to 1V

The minimum operating voltage is 1.6V. As the supply voltage falls below 1.6V, performance degrades and supply current falls. The reference does not



# Single/Dual/Quad, Micropower, Ultra-Low-Voltage, Rail-to-Rail I/O Comparators

## Functional Diagrams

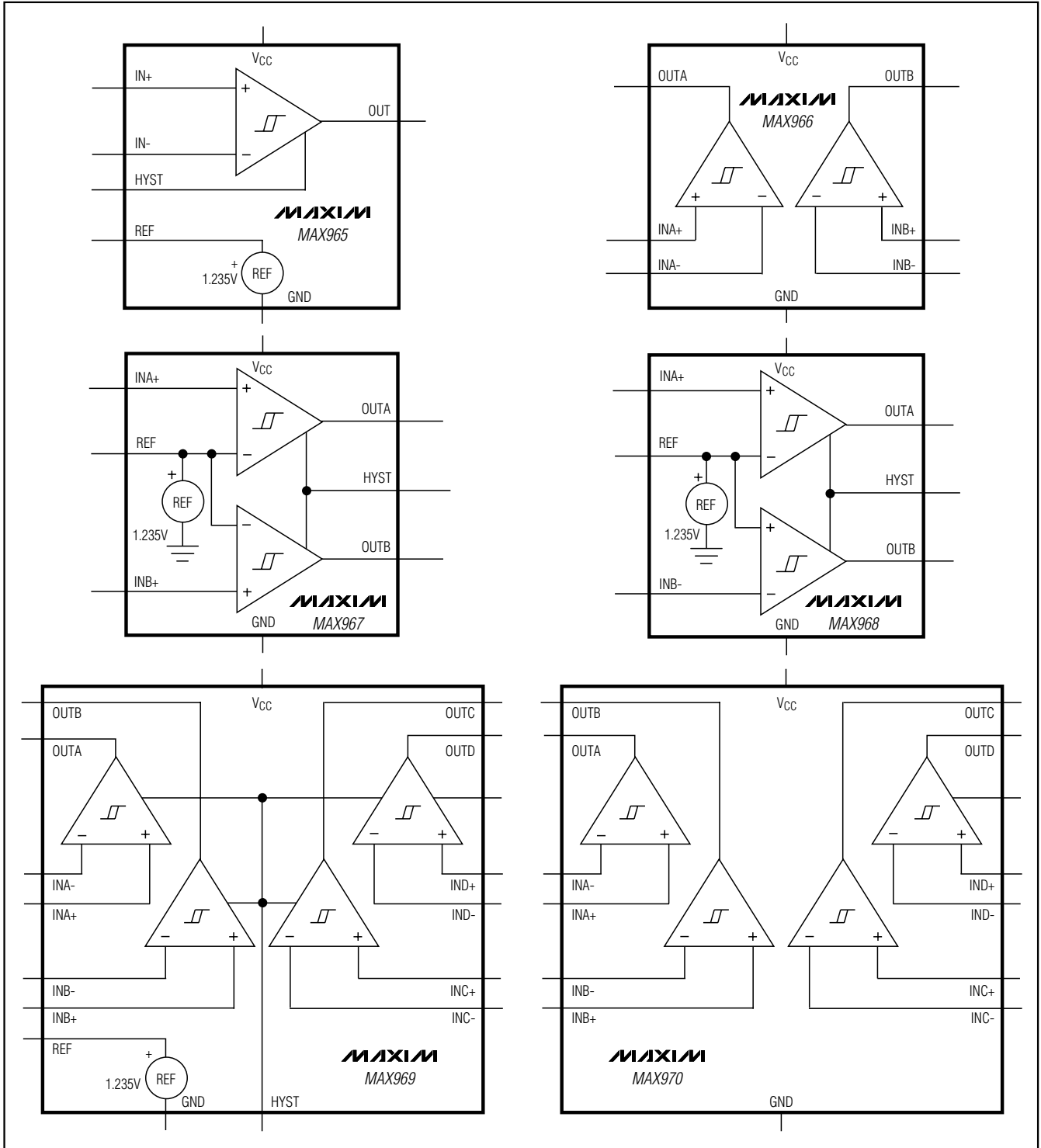

# Single/Dual/Quad, Micropower, Ultra-Low-Voltage, Rail-to-Rail I/O Comparators

function below about 1.5V, although the comparators typically continue to operate with a supply voltage as low as 1V. At low supply voltages (<1.6V), the input common-mode range remains rail-to-rail, but the comparator's output sink capability is reduced and propagation delay increases (see *Typical Operating Characteristics*).

Figure 1 shows a typical comparator application that monitors V<sub>CC</sub> at 1.6V. Resistor divider R1/R2 sets the voltage trip point (V<sub>TRIP</sub>) at 1.6V. As V<sub>CC</sub> drops below 1.6V and approaches 1V, the reference voltage typically falls below the divider voltage (V<sub>+</sub>). This causes the comparator output to change state. If OUT's state must be maintained under these conditions, a latching circuit is required.

### Comparator Output

The MAX965-MAX970 contain a unique slew-rate-controlled output stage capable of rail-to-rail operation with an external pull-up resistor. Typical comparators consume orders of magnitude more current during switching than during steady-state operation. With the MAX965 family of comparators, during an output transition from high to low, the output slew rate is limited to minimize switching current.

### Voltage Reference

With V<sub>CC</sub> greater than 1.6V but less than 5.5V, the internal 1.235V bandgap reference is ±1.5% accurate over the commercial temperature range and ±2.5% accurate over the extended temperature range. The REF output is typically capable of sourcing 50µA. To reduce reference noise or to provide noise immunity, bypass REF with a capacitor (0.1nF to 0.1µF).

### Noise Considerations

The comparator has an effective wideband peak-to-peak noise of around 10µV. The voltage reference has peak-to-peak noise approaching 1.0mV with a 0.1µF bypass capacitor. Thus, when a comparator is used with the reference, the combined peak-to-peak noise is about 1.0mV. This, of course, is much higher than the individual components' RMS noise. Avoid capacitive coupling from any output to the reference pin. Crosstalk can significantly increase the references' actual noise.

## Applications Information

### Hysteresis

Many comparators oscillate in the linear region of operation because of noise or undesired parasitic feedback. This tends to occur when the voltage on one input is equal or very close to the voltage on the other input. The MAX965-MAX970 have internal hysteresis to counter parasitic effects and noise. In addition, with the use of external resistor, the MAX965/MAX967/MAX968/MAX969's hysteresis can be programmed to as much as ±50mV (see the section *Adding Hysteresis to the MAX965/MAX967/MAX968/MAX969*).

The hysteresis in a comparator creates two trip points: one for the rising input voltage and one for the falling input voltage (Figure 2). The difference between the trip points is the hysteresis. When the comparator's input voltages are equal, the hysteresis effectively causes one comparator input voltage to move quickly past the other, thus taking the input out of the region where oscillation occurs.

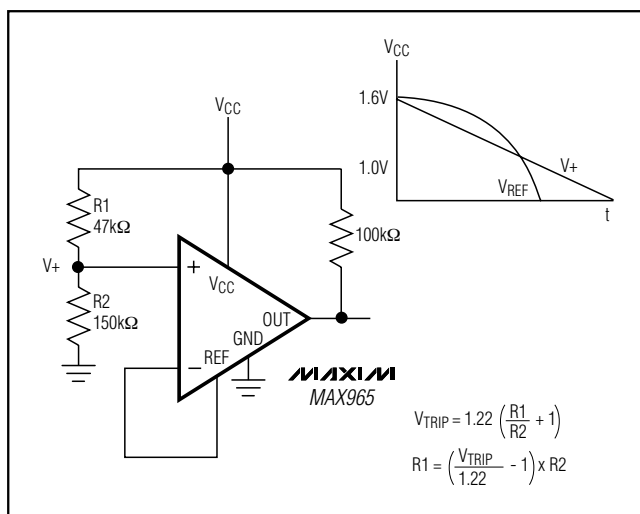

Figure 1. Operation below 1.6V

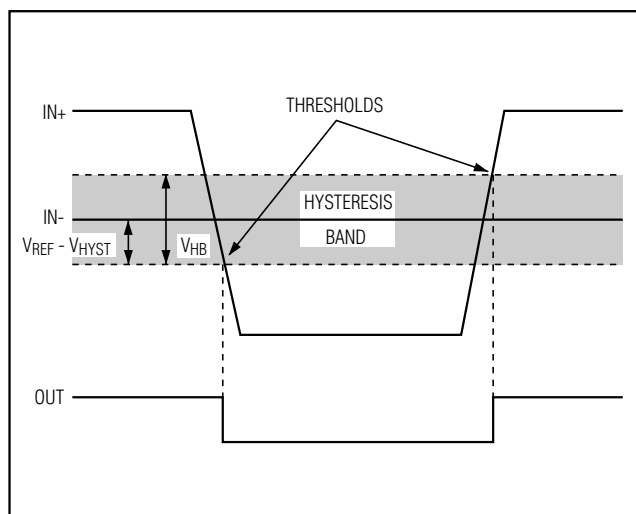

Figure 2. Threshold Hysteresis Band

# Single/Dual/Quad, Micropower, Ultra-Low-Voltage, Rail-to-Rail I/O Comparators

Figure 2 illustrates the case in which IN- has a fixed voltage applied, and IN+ is varied. If the inputs were reversed, the figure would be the same, except with an inverted output.

## Adding Hysteresis to the MAX965/MAX967/MAX968/MAX969

To add hysteresis to the MAX965/MAX967/MAX968/MAX969, connect resistor R1 between REF and HYST, and connect resistor R2 between HYST and GND (Figure 3). If additional hysteresis is not required, connect HYST to REF. When hysteresis is added, the upper and lower trip points change by the same amount in opposite directions. The hysteresis band (the difference between the upper and lower trip points,  $V_{HB}$ ) is approximately twice the voltage between HYST and REF. The HYST input voltage range is from REF down to (REF - 50mV). This yields a hysteresis band from  $\pm 1\text{mV}$  to a maximum of  $\pm 50\text{mV}$ . Calculate the values of R1 and R2 for the desired hysteresis band with the following formulas:

$$R1 = V_{HB} / I_{REF}$$

$$R2 = (V_{REF} - V_{HB}) / I_{REF}$$

where  $I_{REF}$  (the current sourced by the reference) does not exceed the REF source capability (12 $\mu\text{A}$  typical), and is significantly larger than the HYST leakage current (5nA typical).  $I_{REF}$  values between 0.1 $\mu\text{A}$  and 4 $\mu\text{A}$  are good choices. If 2.4M $\Omega$  is chosen for R2 ( $I_{REF} = 0.5\mu\text{A}$ ), the equation for R1 and  $V_{HB}$  can be approximated as:

$$R1(\text{k}\Omega) = 2 \times V_{HB} (\text{mV})$$

In the MAX967/MAX968/MAX969, the HYST pin programs the same hysteresis for all comparators in the package.

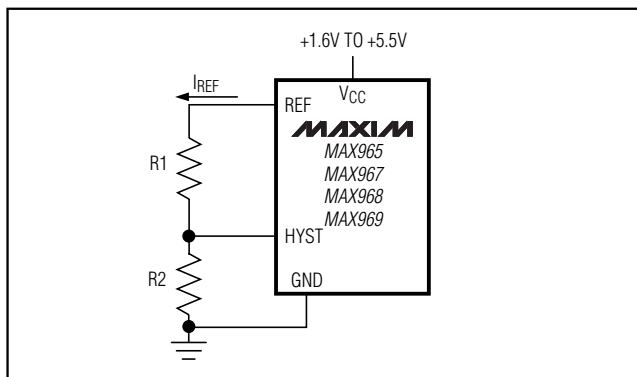

Figure 3. Programming the HYST Pin

Due to the internal structure of the input developed for ultra-low-voltage operation, the hysteresis band varies with common-mode voltage. The graph Programmed Hysteresis vs. Common-Mode Voltage in the *Typical Operating Characteristics* shows this variation. Notice that the hysteresis band increases to almost twice the calculated value toward the ends of the common-mode range. This is apparent only when programming additional hysteresis using the HYST pin. The hysteresis band is constant when HYST is connected to REF.

## Adding Hysteresis to the MAX966/MAX970

The MAX966/MAX970 do not have a HYST pin for programming hysteresis. Hysteresis can be generated with three resistors using positive feedback (Figure 4). This method generally draws more current than the method using the HYST pin on the MAX965/MAX967/MAX968/MAX969. Also, the positive feedback method slows hysteresis response time. Use the following procedure to calculate the resistor values:

- 1) Select R3. The leakage current of IN+ is under 5nA, so the current through R3 should be at least 500nA to minimize errors caused by leakage current. The current through R3 at the trip point is  $(V_{REF} - V_{OUT}) / R3$ . Taking into consideration the two possible output states and solving for R3 yields two formulas:

$$R3 = V_{REF} / 500\text{nA}$$

and

$$R3 = (V_{REF} - V_{CC}) / 500\text{nA}$$

Use the smaller of the two resulting resistor values. For example, if  $V_{REF} = 1.2\text{V}$  and  $V_{CC} = 5.0\text{V}$ , then the two resistor values are 2.4M $\Omega$  and 7.6m $\Omega$ . For R3, choose the 2.2M $\Omega$  standard value.

- 2) Choose the hysteresis band required ( $V_{HB}$ ). For this example, choose 50mV.

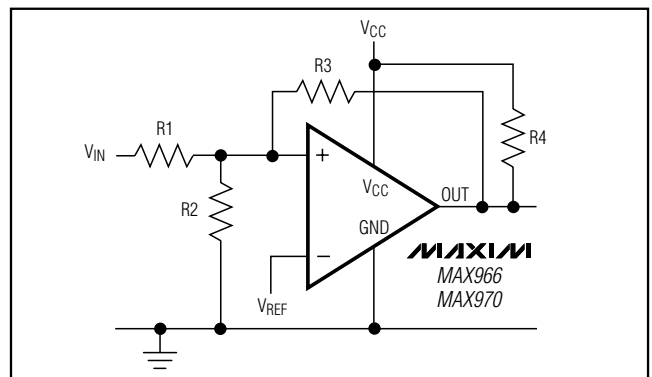

Figure 4. External Hysteresis

# Single/Dual/Quad, Micropower, Ultra-Low-Voltage, Rail-to-Rail I/O Comparators

MAX965-MAX970

- 3) Calculate R1:  $R1 = (R3 + R4) \times (V_{HB} / V_{CC})$ . Putting in the values for this example,  $R1 = (2.2M\Omega + 10k\Omega) \times (50mV / 5.0V) = 22.1k\Omega$ .
- 4) Choose the trip point for  $V_{IN}$  rising. This is the threshold voltage where the comparator output transitions from low to high as  $V_{IN}$  rises above the trip point. For this example, choose 3.0V.
- 5) Calculate R2 as follows:

$$R2 = \frac{1}{\left(\frac{V_{THR}}{V_{REF} \times R1}\right) - \frac{1}{R1} - \frac{1}{R3 + R4}}$$

$$R2 = \frac{1}{\left(\frac{3.0V}{1.2 \times 22k\Omega}\right) - \frac{1}{22k\Omega} - \frac{1}{2.2M\Omega + 10k\Omega}} = 14.76k\Omega$$

where  $V_{THR}$  is the rising-voltage trip threshold. Choose a standard value of 15k $\Omega$ .

- 6) Verify trip voltages and hysteresis as follows:

$V_{IN}$  rising:

$$V_{THR} = V_{REF} \times R1 \times \left(\frac{1}{R1} + \frac{1}{R2} + \frac{1}{R3 + R4}\right)$$

$V_{IN}$  falling:

$$V_{THF} = V_{THR} - \left(\frac{R1 \times V_{CC}}{R3 + R4}\right)$$

$$\text{Hysteresis} = V_{THR} - V_{THF}$$

where  $V_{THR}$  is the rising-voltage trip point, and  $V_{THF}$  is the falling-voltage trip point.

### Circuit Layout and Bypassing

Power-supply bypass capacitors are not needed if supply impedance is low, but 100nF bypass capacitors should be used when supply impedance is high or when supply leads are long. Minimize signal lead lengths to reduce stray capacitance between the input and output that might cause instability.

### IR Receiver

Figure 5 shows an application using the MAX965 as an infrared receiver. The infrared photodiode creates a current relative to the amount of infrared light present. This current creates a voltage across R1. When this voltage level crosses the reference voltage applied to the inverting input, the output transitions. Optional R3 provides additional hysteresis for noise immunity.

### 2-Cell to TTL Logic-Level Shifter

Figure 6 shows an application using the MAX965 to convert a 2-cell voltage-level signal into a TTL-compatible signal. The supply voltage for the comparator comes from the 2-cell supply. The output is pulled up to a 5V supply.

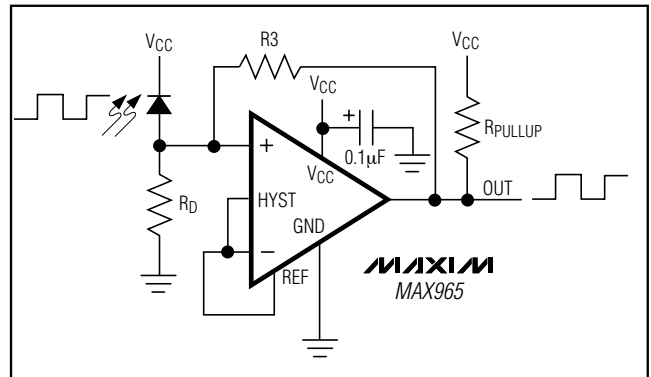

Figure 5. IR Receiver

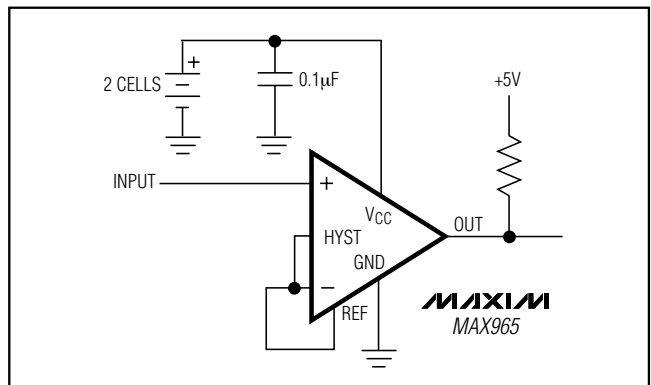
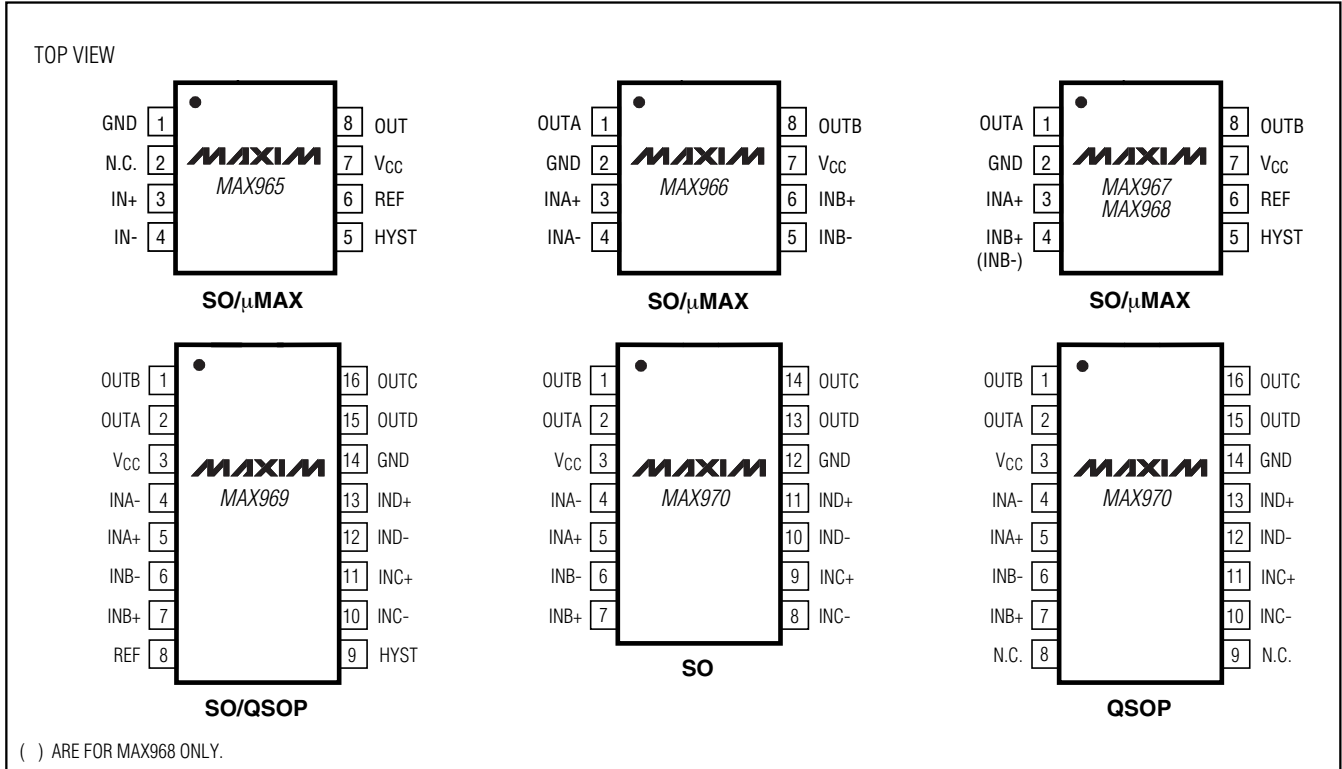

Figure 6. 2-Cell to TTL Logic-Level Translator

# Single/Dual/Quad, Micropower, Ultra-Low-Voltage, Rail-to-Rail I/O Comparators

## Pin Configurations



### Ordering Information (continued)

PART	TEMP RANGE	PIN-PACKAGE	PKG CODE
MAX968ESA	-40°C to +85°C	8 SO	S8-2
MAX968EUA-T	-40°C to +85°C	8 μMAX-8	U8-1
MAX969ESE	-40°C to +85°C	16 Narrow SO	S16-1
MAX969EEE	-40°C to +85°C	16 QSOP	E16-1
MAX970ESD	-40°C to +85°C	14 SO	S14-4
MAX970EEE	-40°C to +85°C	16 QSOP	E16-1

### Chip Information

#### TRANSISTOR COUNTS:

MAX965 = 216  
 MAX966 = 190  
 MAX967/MAX968 = 299  
 MAX969 = 465  
 MAX970 = 380

# Single/Dual/Quad, Micropower, Ultra-Low-Voltage, Rail-to-Rail I/O Comparators

## Package Information

(The package drawing(s) in this data sheet may not reflect the most current specifications. For the latest package outline information go to [www.maxim-ic.com/packages](http://www.maxim-ic.com/packages).)

MAX965-MAX970

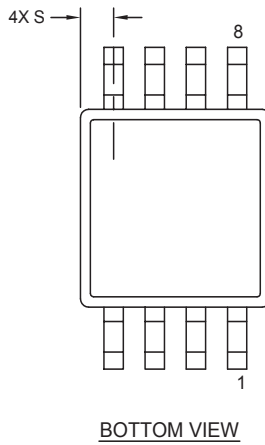
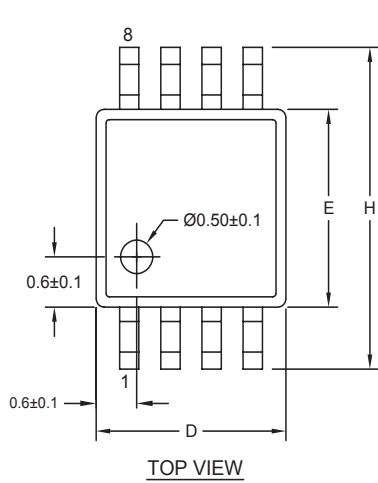

DIM	INCHES		MILLIMETERS	
	MIN	MAX	MIN	MAX
A	-	0.043	-	1.10
A1	0.002	0.006	0.05	0.15
A2	0.030	0.037	0.75	0.95
b	0.010	0.014	0.25	0.36
c	0.005	0.007	0.13	0.18
D	0.116	0.120	2.95	3.05
e	0.0256 BSC		0.65 BSC	
E	0.116	0.120	2.95	3.05
H	0.188	0.198	4.78	5.03
L	0.016	0.026	0.41	0.66
$\alpha$	0°	6°	0°	6°
S	0.0207 BSC		0.5250 BSC	

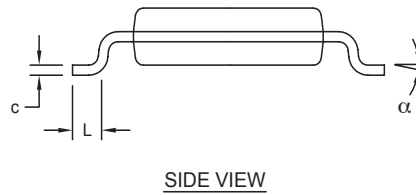
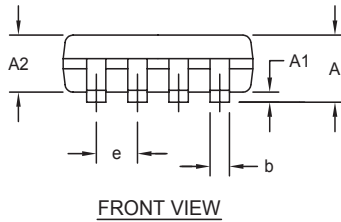

**NOTES:**

1. D&E DO NOT INCLUDE MOLD FLASH.
2. MOLD FLASH OR PROTRUSIONS NOT TO EXCEED 0.15MM (.006").
3. CONTROLLING DIMENSION: MILLIMETERS.
4. MEETS JEDEC MO-187C-AA.

<small>PROPRIETARY INFORMATION</small>	
<small>TITLE:</small> PACKAGE OUTLINE, 8L uMAX/uSOP	
<small>APPROVAL</small>	<small>DOCUMENT CONTROL NO.</small> 21-0036
<small>REV.</small> J	<small>1/1</small>

# Single/Dual/Quad, Micropower, Ultra-Low-Voltage, Rail-to-Rail I/O Comparators

## Package Information (continued)

(The package drawing(s) in this data sheet may not reflect the most current specifications. For the latest package outline information go to [www.maxim-ic.com/packages](http://www.maxim-ic.com/packages).)

SOICN .EPS

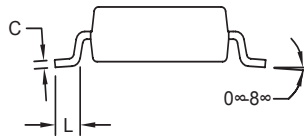
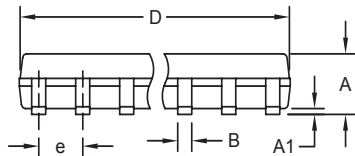
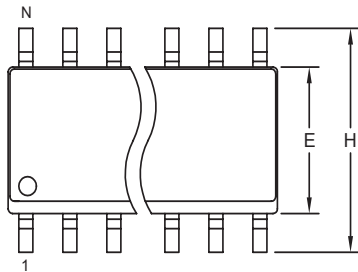

DIM	INCHES		MILLIMETERS	
	MIN	MAX	MIN	MAX
A	0.053	0.069	1.35	1.75
A1	0.004	0.010	0.10	0.25
B	0.014	0.019	0.35	0.49
C	0.007	0.010	0.19	0.25
e	0.050 BSC		1.27 BSC	
E	0.150	0.157	3.80	4.00
H	0.228	0.244	5.80	6.20
L	0.016	0.050	0.40	1.27

VARIATIONS:

DIM	INCHES		MILLIMETERS		N	MS012
	MIN	MAX	MIN	MAX		
D	0.189	0.197	4.80	5.00	8	AA
D	0.337	0.344	8.55	8.75	14	AB
D	0.386	0.394	9.80	10.00	16	AC

**NOTES:**

1. D&E DO NOT INCLUDE MOLD FLASH.
2. MOLD FLASH OR PROTRUSIONS NOT TO EXCEED 0.15mm (.006").
3. LEADS TO BE COPLANAR WITHIN 0.10mm (.004").
4. CONTROLLING DIMENSION: MILLIMETERS.
5. MEETS JEDEC MS012.
6. N = NUMBER OF PINS.

<small>PROPRIETARY INFORMATION</small>		
<small>TITLE:</small> <b>PACKAGE OUTLINE, .150" SOIC</b>		
<small>APPROVAL</small>	<small>DOCUMENT CONTROL NO.</small> <b>21-0041</b>	<small>REV.</small> <b>B</b> <span style="float: right;">1/1</span>

### Revision History

Pages changed at Rev 3: 1-7, 9, 11, 12, 14

Maxim cannot assume responsibility for use of any circuitry other than circuitry entirely embodied in a Maxim product. No circuit patent licenses are implied. Maxim reserves the right to change the circuitry and specifications without notice at any time.

14 **Maxim Integrated Products, 120 San Gabriel Drive, Sunnyvale, CA 94086 (408) 737-7600**