



Chipsmall Limited consists of a professional team with an average of over 10 year of expertise in the distribution of electronic components. Based in Hongkong, we have already established firm and mutual-benefit business relationships with customers from,Europe,America and south Asia,supplying obsolete and hard-to-find components to meet their specific needs.

With the principle of "Quality Parts,Customers Priority,Honest Operation,and Considerate Service",our business mainly focus on the distribution of electronic components. Line cards we deal with include Microchip,ALPS,ROHM,Xilinx,Pulse,ON,Everlight and Freescale. Main products comprise IC,Modules,Potentiometer,IC Socket,Relay,Connector.Our parts cover such applications as commercial,industrial, and automotives areas.

We are looking forward to setting up business relationship with you and hope to provide you with the best service and solution. Let us make a better world for our industry!



## Contact us

Tel: +86-755-8981 8866 Fax: +86-755-8427 6832

Email & Skype: info@chipsmall.com Web: www.chipsmall.com

Address: A1208, Overseas Decoration Building, #122 Zhenhua RD., Futian, Shenzhen, China





# MAX9987/MAX9988 Evaluation Kits

## General Description

The MAX9987/MAX9988 evaluation kits (EV kits) simplify the evaluation of the MAX9987/MAX9988 LO buffers/splitters. They are fully assembled and tested at the factory. Standard 50Ω SMA connectors are included on the EV kits for the input and all three outputs to allow quick and easy evaluation on the test bench.

This document provides a list of equipment required to evaluate the device, a straight-forward test procedure to verify functionality, a circuit schematic for the EV kits, a bill of materials (BOM) for the EV kits, and artwork for each layer of the PC boards.

## Component Suppliers

SUPPLIER	PHONE	WEBSITE
Johnson	507-833-8822	www.johnsoncomponents.com
Murata	770-436-1300	www.murata.com

## MAX9987 Component List

DESIGNATION	QTY	DESCRIPTION
C1, C6	2	0.1μF ±5% capacitors (0603) Murata GRM188R71C104K
C2, C4, C5, C7, C8, C9, C12–C15	10	47pF ±5% capacitors (0603) Murata GRM1885C1H470J
C3	1	100pF ±5% capacitors (0603) Murata GRM1885C1H101J
C10, C11	2	5pF ±0.25pF capacitors (0603) Murata GRM1885C11H5R0C
J1–J4	4	PC board edge-mount SMA connectors (Flat tab launch) Johnson 142-0741-856
R1, R2, R4, R5	4	Not installed
R3	1	100Ω ±5% resistor (0603)
TP1	1	Large test point for 0.062in PC board (red) Mouser 151-107
TP2	1	Large test point for 0.062in PC board (black) Mouser 151-103
U1	1	MAX9987EGP-T

## Features

- ◆ Fully Assembled and Tested
- ◆ Two-Way Power Splitting
- ◆ +14dBm to +20dBm Output Power
- ◆ ±1dB Output Power Variation
- ◆ Isolated PLL Output (+3dBm)
- ◆ Low Output Noise  
-170dBc/Hz at +17dBm
- ◆ 40dB Reverse Isolation
- ◆ More than 30dB Output-to-Output Isolation
- ◆ 160mA Supply Current at +17dBm
- ◆ ESD Protection

## Ordering Information

PART	TEMP RANGE	IC PACKAGE	FREQUENCY RANGE (MHz)
MAX9987EVKIT	-40°C to +85°C	20 QFN	700 to 1100
MAX9988EVKIT	-40°C to +85°C	20 QFN	1500 to 2200

## MAX9988 Component List

DESIGNATION	QTY	DESCRIPTION
C1, C3, C6	3	0.1μF ±5% capacitors (0603) Murata GRM188R71C104K
C2, C4, C5, C7, C8, C9, C12–C15	10	22pF ±5% capacitors (0603) Murata GRM1885C1H220J
C10, C11	2	10pF ±5% capacitors (0603) Murata GRM1885C1H100J
J1–J4	4	PC board edge-mount SMA connectors (Flat tab launch) Johnson 142-0741-856
R1, R2, R4, R5	4	Not installed
R3	1	100Ω ±5% resistor (0603)
TP1	1	Large test point for 0.062in PC board (red) Mouser 151-107
TP2	1	Large test point for 0.062in PC board (black) Mouser 151-103
U1	1	MAX9988EGP-T

Evaluate: MAX9987/MAX9988

# MAX9987/MAX9988 Evaluation Kits

## Quick Start

The MAX9987/MAX9988 EV kits are fully assembled and factory tested. Follow the instructions in the *Connections and Setup* section for proper device evaluation.

### Test Equipment Required

Table 1 lists the equipment required to verify the operation of the MAX9987/MAX9988 EV kits. It is intended as a guide only, and some substitutions are possible.

### Connections and Setup

This section provides a step-by-step guide to testing the basic functionality of the EV kits. As a general precaution to prevent damaging the outputs by driving high-VSWR loads, **do not turn on DC power or RF signal generators until all connections are made.**

- 1) Calibrate the power meter at 900MHz for the MAX9987, or at 1800MHz for the MAX9988. Important: Use a power sensor rated to at least 0dBm. Measure the loss in the 20dB attenuator (pad) that will be connected to OUT1; account for this loss as an offset in the power meter.
- 2) Connect the 20dB pad to OUT1. The 20dB pad maintains a reasonable load VSWR for the output driver and protects the RF equipment from accidental overload.
- 3) Connect a 50Ω termination to OUT2.
- 4) For the MAX9987, set the RF signal generator for 900MHz CW (i.e., unmodulated) at +10dBm (accounts for 3dB loss of input pad); for the MAX9988, set the generator for 1800MHz at +12dBm. Connect generator to EV kit input through a 3dB pad. Disable the RF output until all connections are made.
- 5) Connect the power sensor to OUT1's 20dB pad.
- 6) Set DC supply to +5.0V (set current limit around 250mA, if possible), and connect supplies to the EV kit through the ammeter.
- 7) Enable the RF signal generator's output.

## Testing the Buffers/Splitters

- 1) From the procedure above, the power meter should be reading a power of about +17dBm.
- 2) Ensure that the supply current is not more than 175mA at VCC = 5.25V and PIN = +10dBm.
- 3) Disable the RF generator, turn off the DC supply and swap the power detector/power pad to OUT2 (moving the 50Ω termination to OUT1), and re-check output power level and stability over supply, input power, and frequency, if desired.
- 4) Leaving the 20dB pad and 50Ω termination connected to OUT2 and OUT1, move the power detector to OUTPLL and verify an output level of around +3dBm.

**Table 1. List of Required Equipment**

EQUIPMENT	QTY	DESCRIPTION
HP E3631A	1	Power supply
Fluke 75 series II	1	Digital MultiMeter
HP/Agilent 8648B	1	RF signal generator
HP 437B	1	RF power meter
HP 8482A	1	High-power sensor (power head)
20dB pad	1	20dB (1W) attenuators
50Ω termination	1	50Ω (1W) termination

## Layout Considerations

A properly designed PC board is an essential part of any RF/microwave circuit. Keep RF signal lines as short as possible to reduce losses, radiation, and inductance. For best performance, route the ground pin traces directly to the exposed paddle underneath the package. This paddle should be connected to the ground plane of the board by using multiple vias under the device to provide the best RF/thermal conduction path. Solder the exposed paddle, on the bottom of the device package, to a PC board exposed pad.

# MAX9987/MAX9988 Evaluation Kits

Evaluate: MAX9987/MAX9988

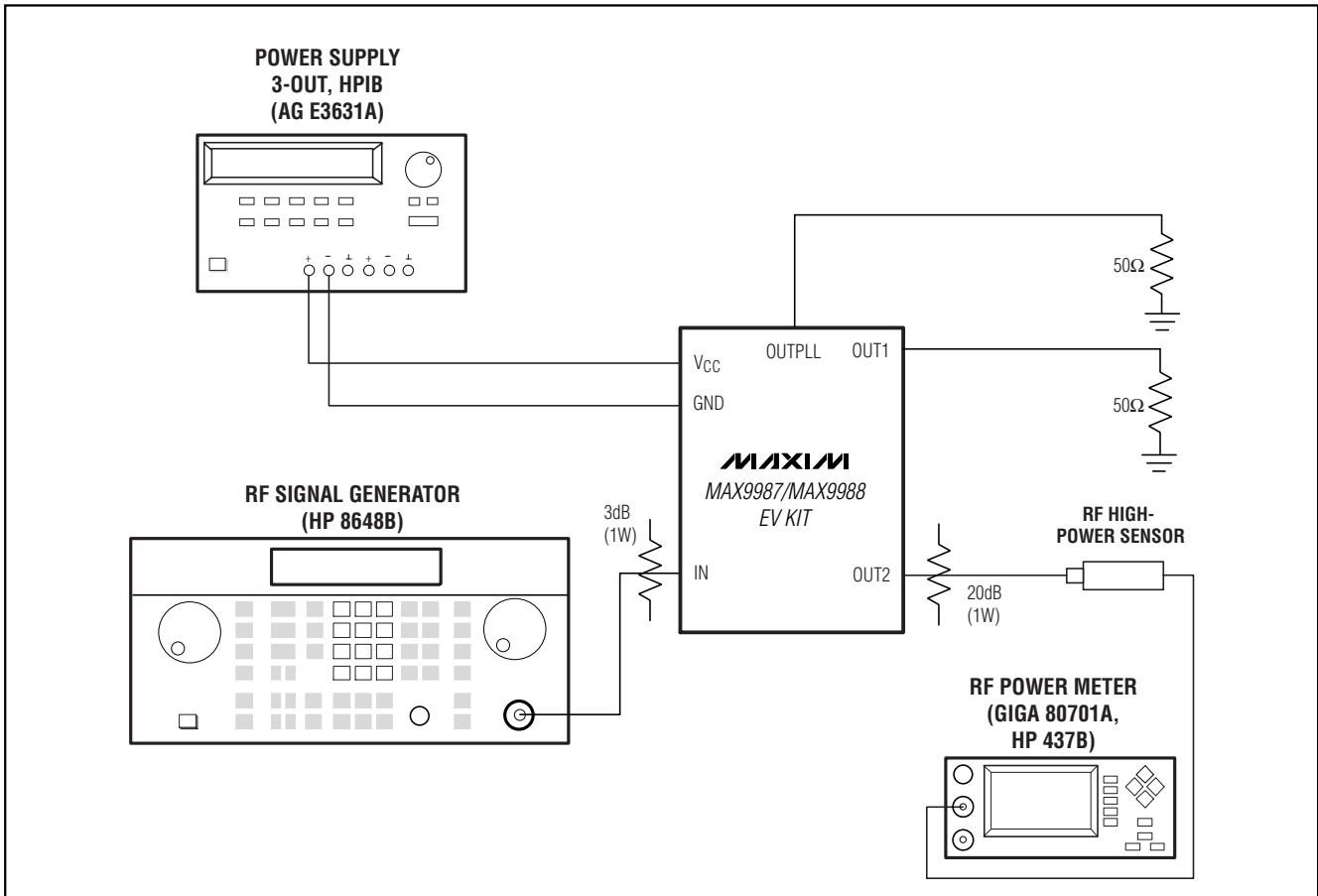

Figure 1. Test Setup Diagram

# MAX9987/MAX9988 Evaluation Kits

**Evaluate: MAX9987/MAX9988**

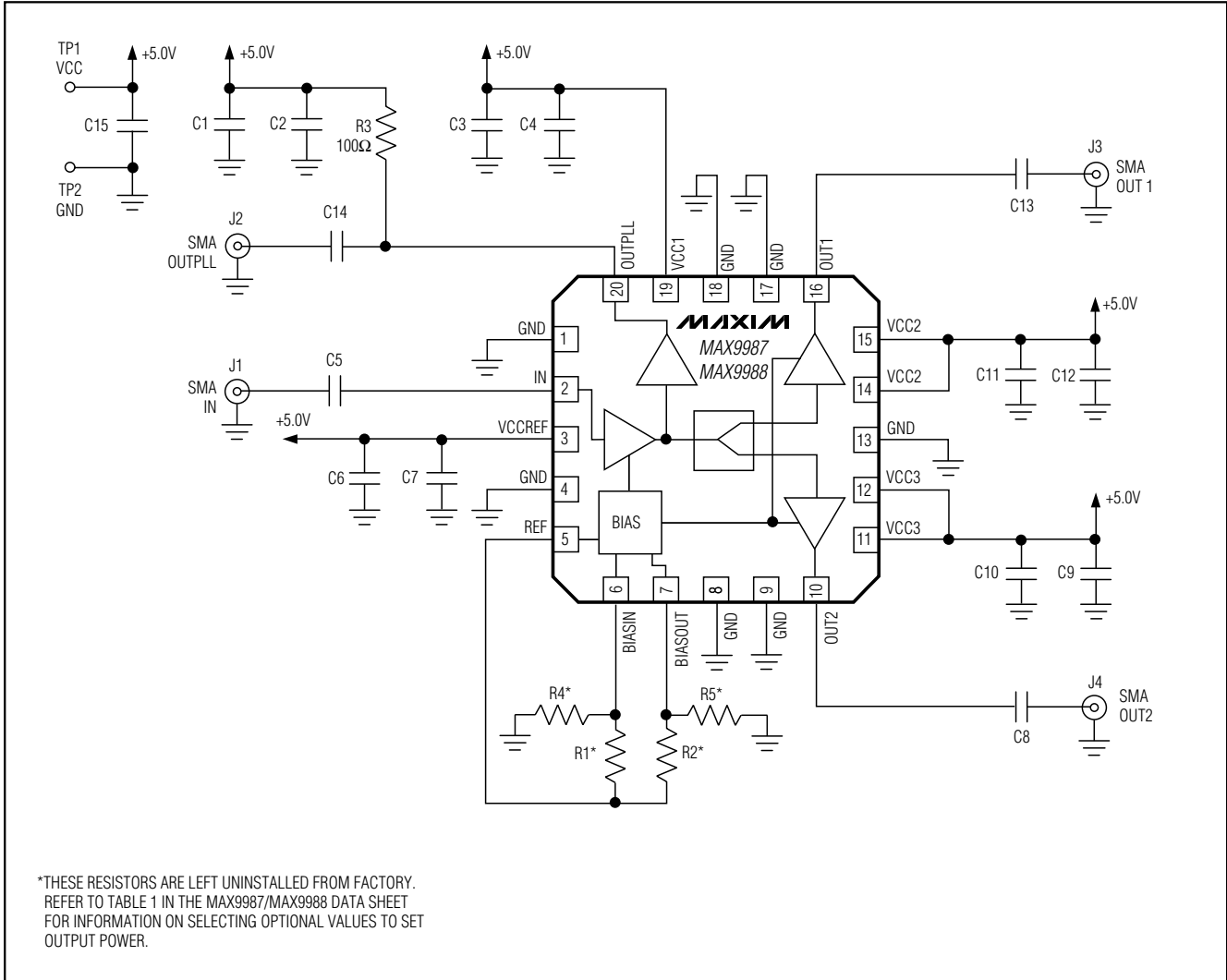

Figure 2. MAX9987/MAX9988 EV Kit Schematic

# MAX9987/MAX9988 Evaluation Kits

Evaluate: MAX9987/MAX9988

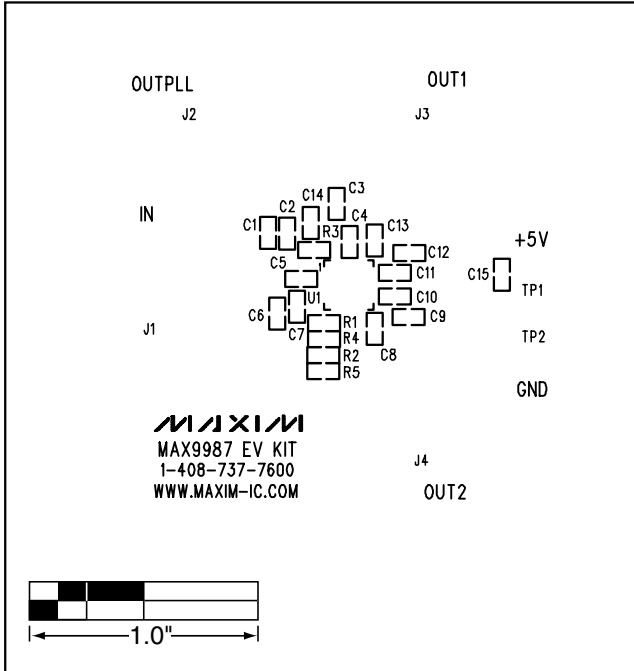

Figure 3a. MAX9987 EV Kit PC Board Layout—Top Silkscreen

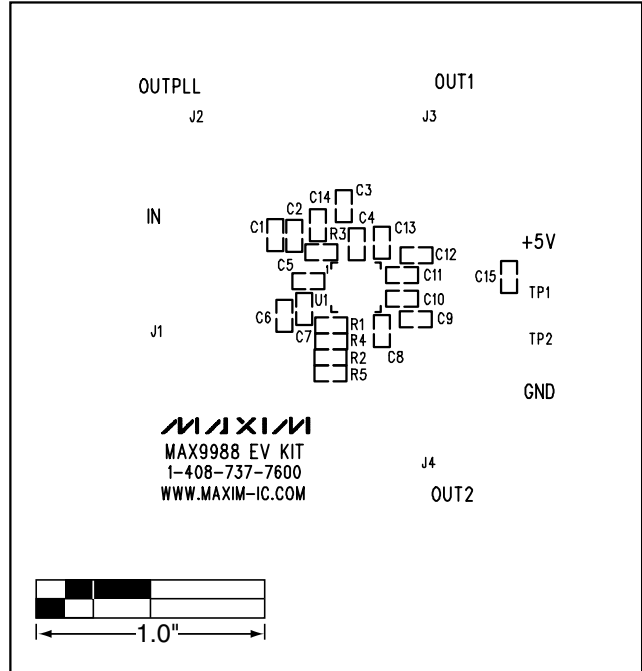

Figure 3b. MAX9988 EV Kit PC Board Layout—Top Silkscreen

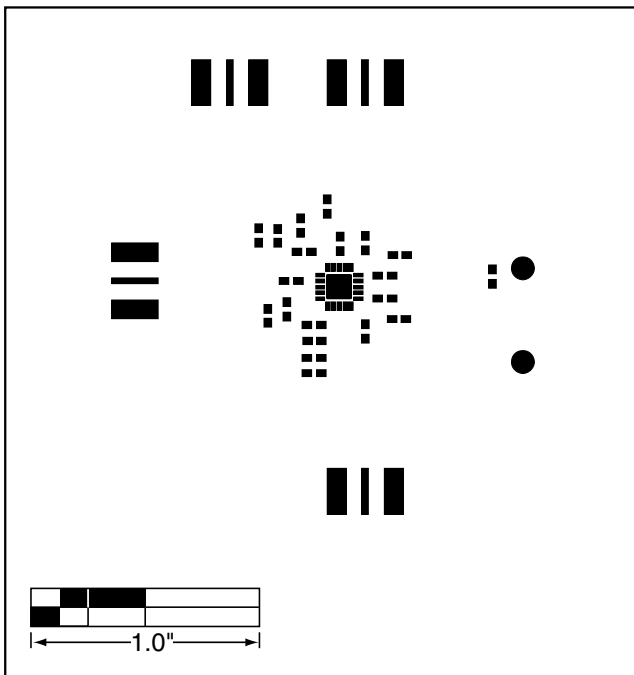

Figure 4. MAX9987/MAX9988 EV Kit PC Board Layout—Top Soldermask

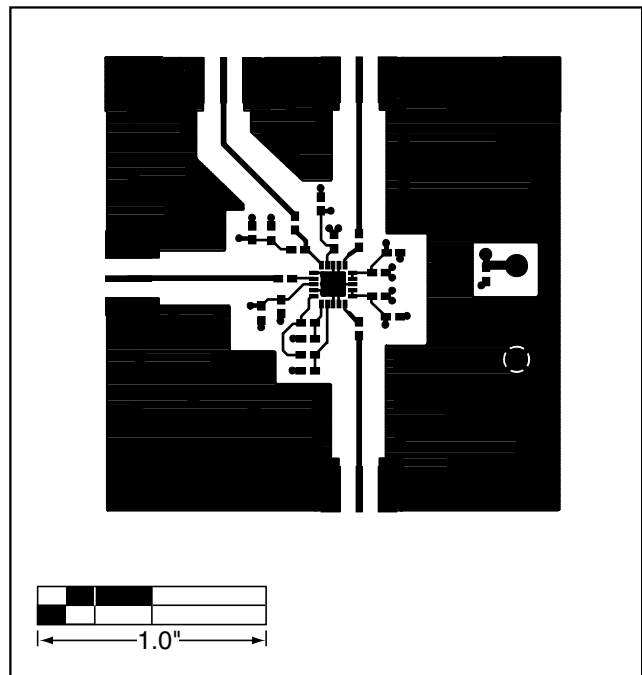

Figure 5. MAX9987/MAX9988 EV Kit PC Board Layout—Top Layer

# MAX9987/MAX9988 Evaluation Kits

Evaluate: MAX9987/MAX9988

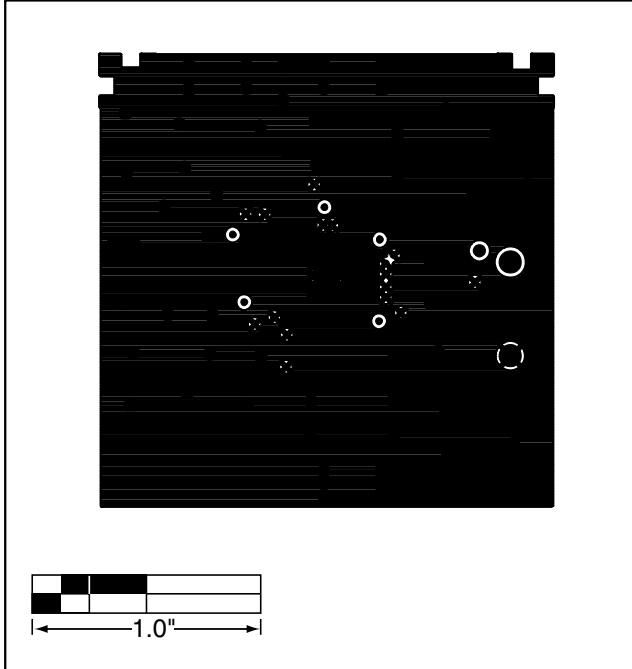

Figure 6. MAX9987/MAX9988 EV Kit PC Board Layout—Inner Layer 2 (Gnd)

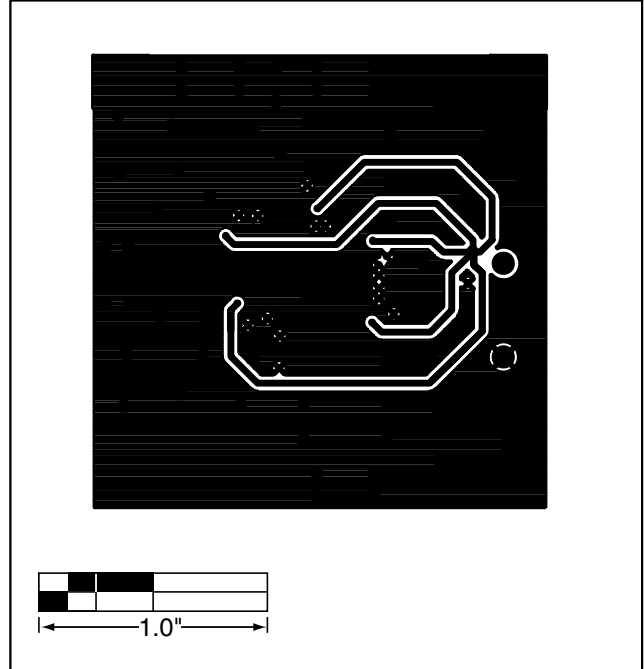

Figure 7. MAX9987/MAX9988 EV Kit PC Board Layout—Inner Layer 3 (Routes)

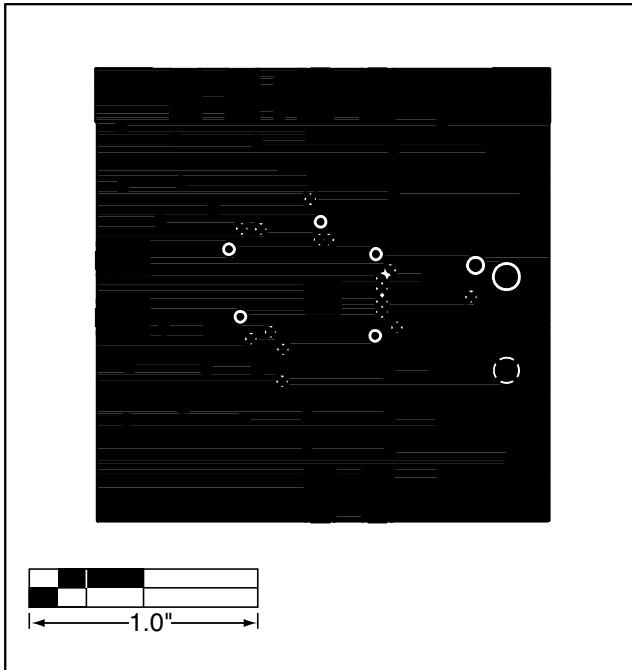

Figure 8. MAX9987/MAX9988 EV Kit PC Board Layout—Bottom Layer

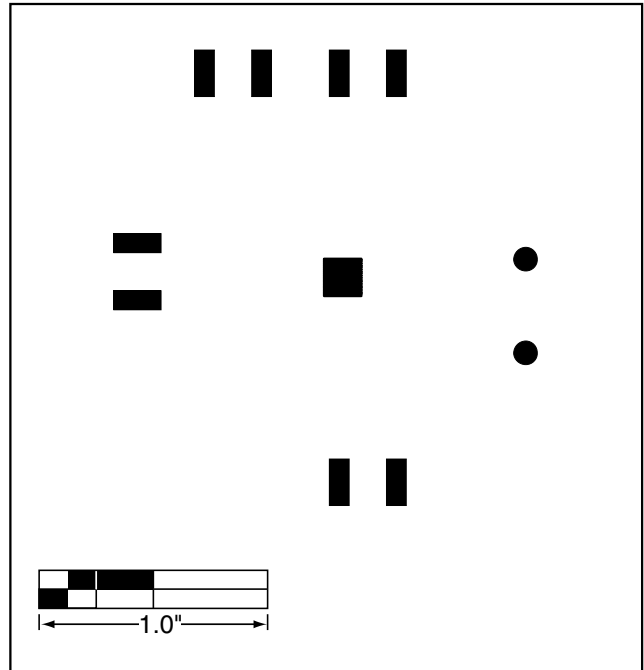

Figure 9. MAX9987/MAX9988 EV Kit PC Board Layout—Bottom Soldermask

# MAX9987/MAX9988 Evaluation Kits

Evaluate: MAX9987/MAX9988

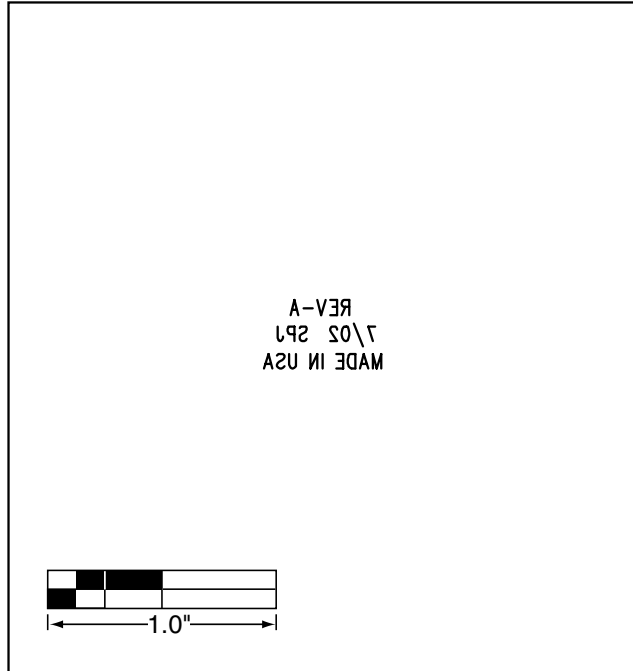

Figure 10. MAX9987/MAX9988 EV Kit PC Board Layout—  
Bottom Silkscreen

Maxim cannot assume responsibility for use of any circuitry other than circuitry entirely embodied in a Maxim product. No circuit patent licenses are implied. Maxim reserves the right to change the circuitry and specifications without notice at any time.

Maxim Integrated Products, 120 San Gabriel Drive, Sunnyvale, CA 94086 408-737-7600 \_\_\_\_\_ 7