



Chipsmall Limited consists of a professional team with an average of over 10 year of expertise in the distribution of electronic components. Based in Hongkong, we have already established firm and mutual-benefit business relationships with customers from,Europe,America and south Asia,supplying obsolete and hard-to-find components to meet their specific needs.

With the principle of “Quality Parts,Customers Priority,Honest Operation,and Considerate Service”,our business mainly focus on the distribution of electronic components. Line cards we deal with include Microchip,ALPS,ROHM,Xilinx,Pulse,ON,Everlight and Freescale. Main products comprise IC,Modules,Potentiometer,IC Socket,Relay,Connector.Our parts cover such applications as commercial,industrial, and automotives areas.

We are looking forward to setting up business relationship with you and hope to provide you with the best service and solution. Let us make a better world for our industry!



Contact us

Tel: +86-755-8981 8866 Fax: +86-755-8427 6832

Email & Skype: info@chipsmall.com Web: www.chipsmall.com

Address: A1208, Overseas Decoration Building, #122 Zhenhua RD., Futian, Shenzhen, China



MAXIM

MAX9993 Evaluation Kit

Evaluates: MAX9993

General Description

The MAX9993 evaluation kit (EV kit) simplifies the evaluation of the MAX9993 UMTS, DCS, and PCS base-station downconversion mixer. It is fully assembled and tested at the factory. Standard 50Ω SMA connectors are included on the EV kit for the input and output to allow quick and easy evaluation on the test bench.

This document provides a list of equipment required to evaluate the device, a straight-forward test procedure to verify functionality, a description of the EV kit circuit, the circuit schematic, a bill of materials (BOM) for the kit, and artwork for each layer of the PC board.

Contact MaximDirect sales at 888-629-4642 to check on pricing and availability for these kits.

Component Suppliers

SUPPLIER	PHONE	WEBSITE
Coilcraft	800-322-2645	www.coilcraft.com
Digi-key	800-344-4539	www.digikey.com
Johnson	507-833-8822	www.johnsoncomponents.com
Mini-Circuits	718-934-4500	www.minicircuits.com
Murata	770-436-1300	www.murata.com

Features

- ◆ Fully Assembled and Tested
- ◆ +23.5dBm Input IP3
- ◆ 1700MHz to 2200MHz RF Frequency
- ◆ 1400MHz to 2000MHz LO Frequency
- ◆ 40MHz to 350MHz IF Frequency
- ◆ 8.5dB Conversion Gain
- ◆ 9.5dB Noise Figure
- ◆ Integrated LO Buffer
- ◆ Switch-Selectable (SPDT), Two LO Inputs
- ◆ Low 0dBm to +6dBm LO Drive
- ◆ 40dB LO1 to LO2 Isolation

Ordering Information

PART	TEMP RANGE	IC PACKAGE
MAX9993EVKIT	-40°C to +85°C	Thin QFN 20-EP* (5mm x 5mm)

*EP = Exposed paddle.

Component List

DESIGNATION	QTY	DESCRIPTION
C1	1	4.0pF ±0.25pF, 50V C0G-type ceramic capacitor (0603) Murata GRM1885C1H4R0C
C2, C6, C7, C9, C10	5	22pF ±5%, 50V C0G-type ceramic capacitors (0603) Murata GRM1885C1H220J
C3, C5, C8	3	0.01μF ±10%, 50V X7R-type ceramic capacitor (0603) Murata GRM188R71H103K
C4	1	10pF ±5%, 50V C0G-type ceramic capacitor (0603) Murata GRM1885C1H100J
C11, C12, C13	3	150pF ±5%, 50V C0G-type ceramic capacitors (0603) Murata GRM1885C1H151J
J1-J4	4	PC board edge-mount SMA RF connectors (flat tab launch) Johnson 142-0741-856
L1, L2	2	470nH ±5% wire-wound inductors (1008) Coilcraft 1008CS-471XJBC

DESIGNATION	QTY	DESCRIPTION
L3	1	10nH ±5% wire-wound inductor (0805) Coilcraft 0805CS-100XJBC
R1	1	523Ω ±1% resistor (0603)
R2	1	383Ω ±1% resistor (0603)
R3, R4	2	7.15Ω ±1% resistors (1206) Digi-key 311-7.15FCT-ND
R5	1	200Ω ±5% resistor (0603)
R6	1	47kΩ ±5% resistor (0603)
T1	1	4:1 transformer (200:50) Mini-Circuits TC4-1W-7A
TP1	1	Large test point for 0.062in PC board (red) Mouser 151-107
TP2	1	Large test point for 0.062in PC board (black) Mouser 151-103
TP3	1	Large test point for 0.062in PC board (white) Mouser 151-101
U1	1	MAX9993ETP-T**

**The exposed paddle conductor on U1 must be solder attached to a grounded pad on the circuit to ensure a proper electrical/thermal design.

MAX9993 Evaluation Kit

Quick Start

The MAX9993 EV kit is fully assembled and factory tested. Follow the instructions in the *Connections and Setup* section for proper device evaluation.

Test Equipment Required

Table 1 lists the equipment required to verify the operation of the MAX9993 EV kit. It is intended as a guide only, and some substitutions are possible.

Connections and Setup

This section provides a step-by-step guide to testing the basic functionality of the EV kit. As a general precaution to prevent damaging the outputs by driving high-VSWR loads, **do not turn on DC power or RF signal generators until all connections are made.**

This procedure is specific to operation in the U.S. PCS band (reverse channel: 1850MHz to 1910MHz), low-side injected LO for a 200MHz IF. Choose the test frequency based on the particular system's frequency plan, and adjust the following procedure accordingly. See Figure 1 for the mixer test setup diagram.

- 1) Calibrate the power meter for 1700MHz. For safety margin, use a power sensor rated to at least +20dBm, or use padding to protect the power head as necessary.
- 2) Connect 3dB pads to the DUT ends of each of the three RF signal generators' SMA cables. This padding improves VSWR, and reduces the errors due to mismatch.
- 3) Use the power meter to set the RF signal generators according to the following:
 - RF signal source: -5dBm into DUT at 1900MHz (this will be about -2dBm before the 3dB pad)
 - LO1 signal source: +3dBm into DUT at 1700MHz (this will be about +6dBm before the 3dB pad)
 - LO2 signal source: +3dBm into DUT at 1701MHz (this will be about +6dBm before the 3dB pad)
- 4) Disable the signal generator outputs.
- 5) Connect the RF source (with pad) to RF IN.
- 6) Connect the LO1 and LO2 signal sources to the EV kit LO inputs.
- 7) Measure loss in the 3dB pad and the cable that will be connected to IF OUT. Losses are frequency dependent, so test this at 200MHz (the IF frequency). Use this loss as an offset in all output power/gain calculations.
- 8) Connect this 3dB pad to the EV kit's IF OUT connector, and connect a cable from the pad to the spectrum analyzer.

- 9) Set DC supply to +5.0V, and set a current limit around 250mA if possible. Disable the output voltage and connect the supply to the EV kit through the ammeter. Enable the supply. Re-adjust the supply to get +5.0V at the EV kit. There will be a voltage drop across the ammeter when the mixer is drawing current.

- 10) Select LO1 by connecting LOSEL (TP3) to GND.

- 11) Enable the LO and the RF sources.

Table 1. Test Equipment

EQUIPMENT	QTY	DESCRIPTION
HP E3631A	1	DC power supply
Fluke 75 Series II	1	Digital multimeter (ammeter)
HP/Agilent 8648B	3	RF signal generators
HP 437B	1	RF power meter
HP 8482A	1	High-power sensor (power head)
HP 8561	1	Spectrum analyzer
3dB Pad	4	3dB attenuators
50Ω Termination	1	50Ω (1W) termination

Testing the Mixer

Adjust the center and span of the spectrum analyzer to observe the IF output tone at 200MHz. The level should be about +0.5dBm (8.5dB conversion gain, 3dB pad loss). There will also be a tone at 199MHz, which is due to the LO signal applied to LO2. The amount of suppression between the 200MHz and 199MHz signals is the switch isolation. The spectrum analyzer's absolute magnitude accuracy is typically no better than ±1dB. Use the power meter to get an accurate output power measurement.

Disconnect the GND connection to LOSEL. It will be pulled high by a pullup resistor on the board, selecting LO2. Observe that the 199MHz signal increases while the 200MHz decreases.

Reconfigure the test setup using a combiner or hybrid to sum the two LO inputs to do a 2-tone IP3 measurement if desired. Terminate the unused LO input in 50Ω.

Detailed Description

The MAX9993 is a highly integrated downconverter. RF and LO baluns are integrated on-chip, as well as an LO buffer and a SPDT LO input select switch. The EV kit circuit consists mostly of supply decoupling capacitors and DC-blocking capacitors, allowing for a simple design-in.

Supply Decoupling Capacitors

Capacitors C2, C6, and C7 are 22pF (±5%) high-frequency supply decoupling capacitors necessary to keep

MAX9993 Evaluation Kit

high-frequency noise from coupling back into the supply. Capacitors C3 and C8 are larger 0.01 μ F ceramics used for filtering lower frequency noise on the supply.

DC-Blocking Capacitors

The MAX9993 has internal baluns on the RF, LO1 and LO2 inputs. These inputs have almost 0 Ω resistance at DC, and so DC-blocking capacitors C1, C9, and C10 are used to prevent any external bias from being shunted directly to ground. Capacitors C12 and C13 are used to keep DC current from flowing into the transformer, as well as providing the flexibility for matching.

LO BIAS and IF BIAS

Bias currents for the integrated IF output amplifier and the LO buffer are set with resistors R1 (523 Ω , \pm 1%) and R2 (383 Ω , \pm 1%), respectively. These values were carefully chosen for best linearity and lowest supply current through testing at the factory. Changing these values, or using lower tolerance resistors, degrades performance.

Current-Limiting Resistors

Resistors R3 and R4 are used for current limiting at the supply. Resistor R3 dissipates 80mW and R4 dissipates 125mW.

TAP Network

The network at TAP formed by R5 and C5 helps to terminate the second-order intermodulation products at the RF input to balance the upper and lower side-band input IP3 performance.

LEXT

The 10nH (\pm 5%) wire-wound inductor, L3, improves LO-to-IF and RF-to-IF isolation. If isolation is not critical, then this pin can be grounded.

IF \pm

The MAX9993 employs a differential IF output to offer increased IP2 system performance. The EV kit uses a 4:1 balun to transform the 200 Ω differential output impedance to a 50 Ω single-ended output for easy bench evaluation. Inductive pullups L1 and L2 provide DC bias to the IF output amplifier, using C11 for supply filtering and R4 for current limiting. Series capacitors C12 and C13 work in conjunction with the inductors and the 4:1 balun transformer (T1) to match the IF output for 40MHz to 200MHz operation.

As the differential IF outputs are relatively high impedance (200 Ω), they are more susceptible to component parasitics. It is often good practice to relieve the ground plane directly underneath large components to reduce associated shunt-C parasitics.

LO_SEL

The EV kit includes a 47k Ω pullup resistor for easy selection of the LO port. Providing a ground at TP3 selects LO1, and leaving TP3 open selects LO2. To drive TP3 from an external source, follow the limits called out in the MAX9993 device data sheet. Logic voltages should not be applied to TP3 without the +5V supply applied. Doing so can cause the on-chip ESD diodes to conduct and could damage the part.

Layout Considerations

The MAX9993 evaluation board can be a guide for your board layout. Pay close attention to thermal design and close placement of components to the IC. The MAX9993 package exposed paddle (EP) conducts heat from the device and provides a low-impedance electrical connection to the ground plane. The EP must be attached to the PC board ground plane with a low thermal and electrical impedance contact. Ideally, this is achieved by soldering the backside of the package directly to a top metal ground plane on the PC board. Alternatively, the EP can be connected to an internal or bottom-side ground plane using an array of plated vias directly below the EP.

Depending on the ground plane spacing, large surface-mount pads in the IF path may need to have the ground plane relieved under them to reduce parasitic shunt capacitance.

Modifying the EV Kit

The RF and LO inputs are broadband matched, so there is no need to modify the circuit for use anywhere in the 1700MHz to 2200MHz RF range (1400MHz to 2000MHz LO range).

Retuning for a different IF is as simple as scaling the values of the IF pullup inductors up or down with frequency. The IF output looks like 200 Ω differential in parallel with a capacitor. The capacitance is due to the combination of the IC, PC board, and external IF components. The capacitance is approximately 4pF (per output) to ground. This capacitance is resonated out at the frequency of interest by the bias inductors L1 and L2. To determine the inductor value use the following equation:

$$f_{IF} = \frac{1}{2\pi\sqrt{L \times C}}$$

The IF output is tuned for operation at approximately 100MHz, so a 470nH inductor is used. For lower IF frequencies (i.e., larger component values), maintain the component's Q value at the cost of larger case size, unless it is unavoidable.

MAX9993 Evaluation Kit

Evaluates: MAX9993

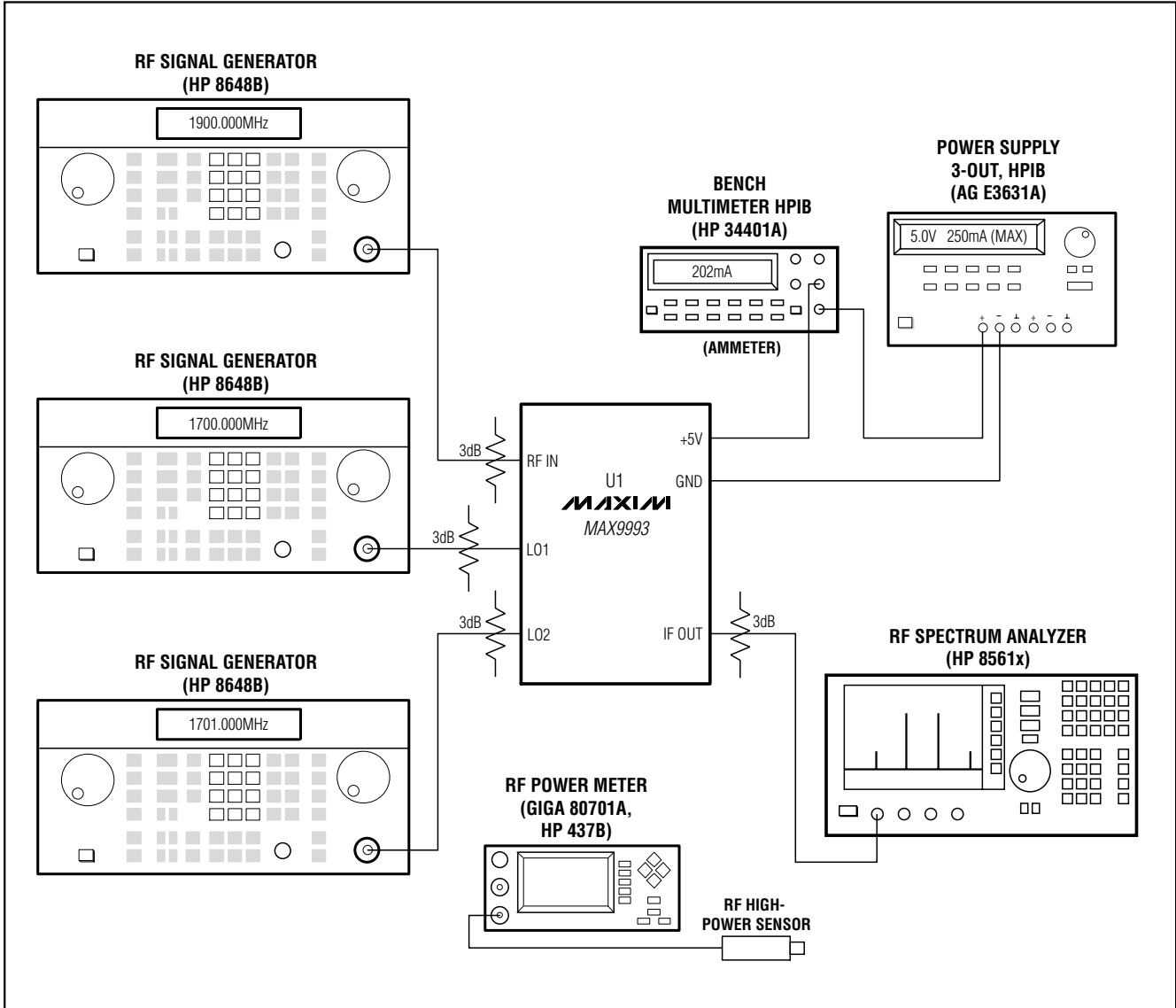

Figure 1. Test Setup Diagram

MAX9993 Evaluation Kit

Evaluates: MAX9993

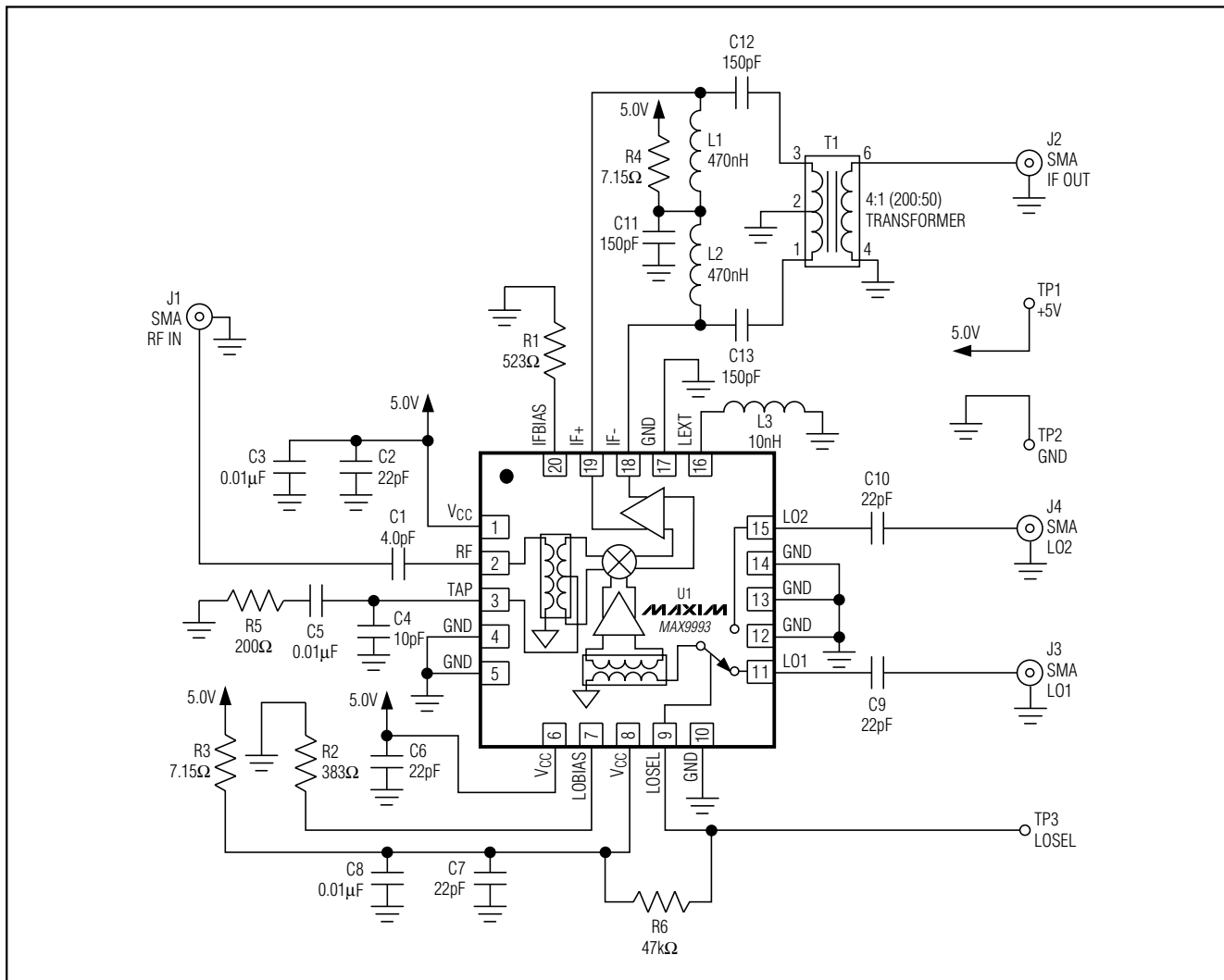

Figure 2. MAX9993 EV Kit Schematic

MAX9993 Evaluation Kit

Evaluates: MAX99993

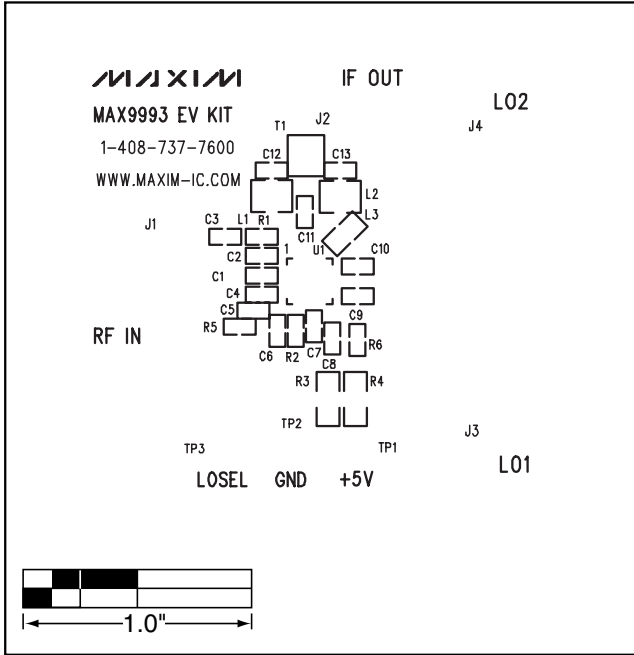

Figure 3. MAX9993 EV Kit PC Board Layout—Top Silkscreen

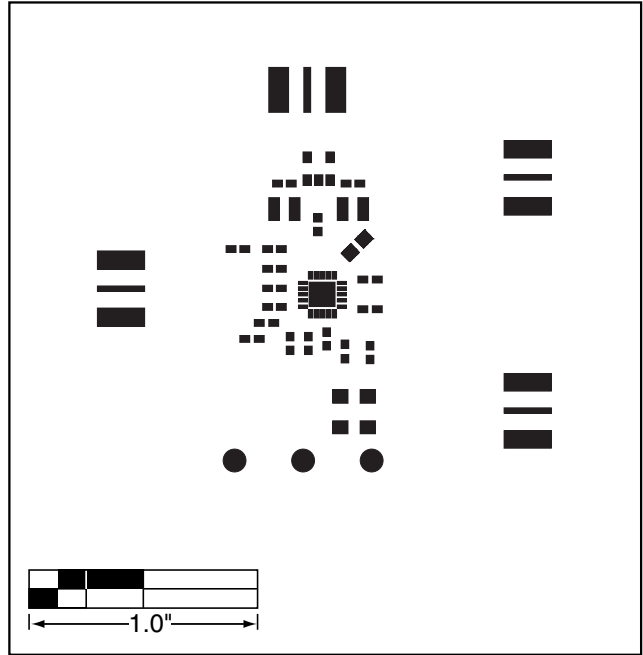

Figure 4. MAX9993 EV Kit PC Board Layout—Top Soldermask

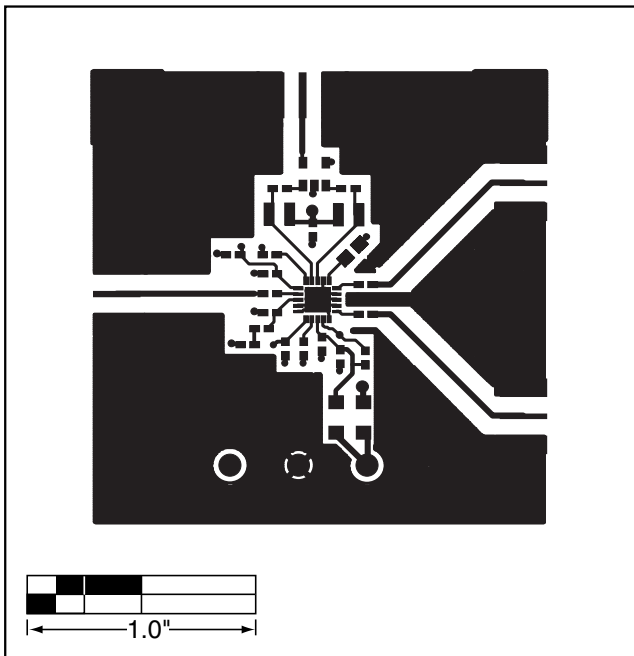

Figure 5. MAX9993 EV Kit PC Board Layout—Top Layer Metal

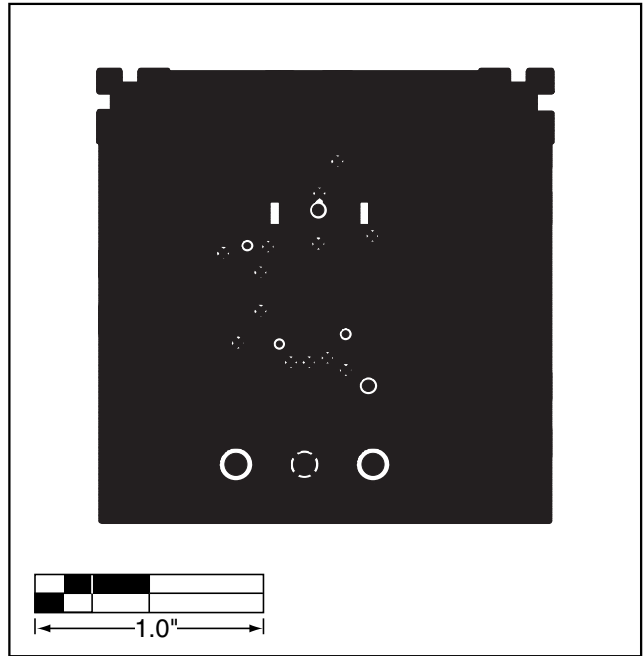

Figure 6. MAX9993 EV Kit PC Board Layout—Inner Layer 2 (GND)

MAX9993 Evaluation Kit

Evaluates: MAX9993

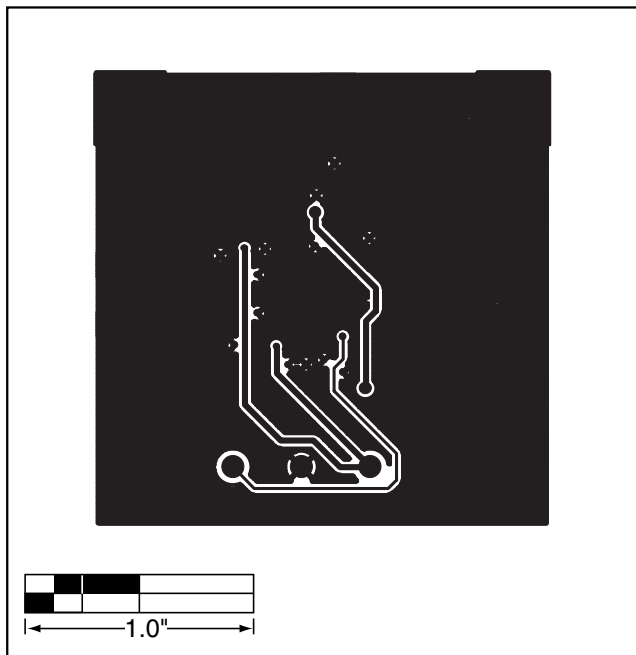

Figure 7. MAX9993 EV Kit PC Board Layout—Inner Layer 3 (Routes)

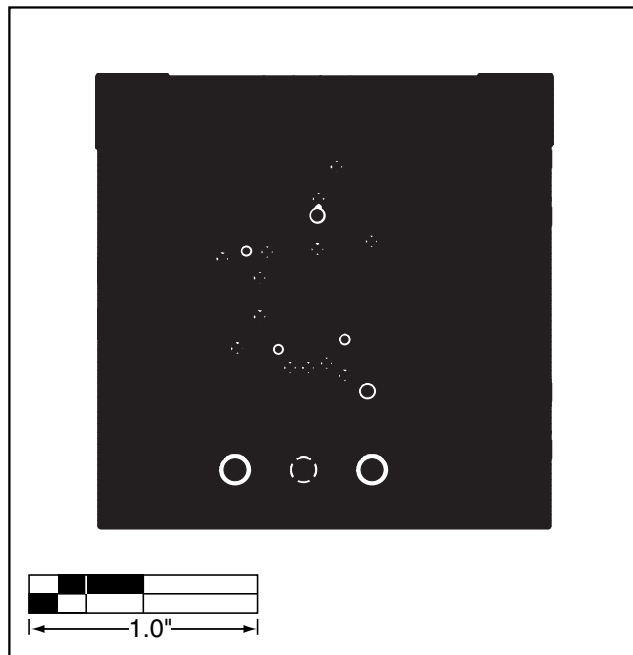

Figure 8. MAX9993 EV Kit PC Board Layout—Bottom Layer Metal

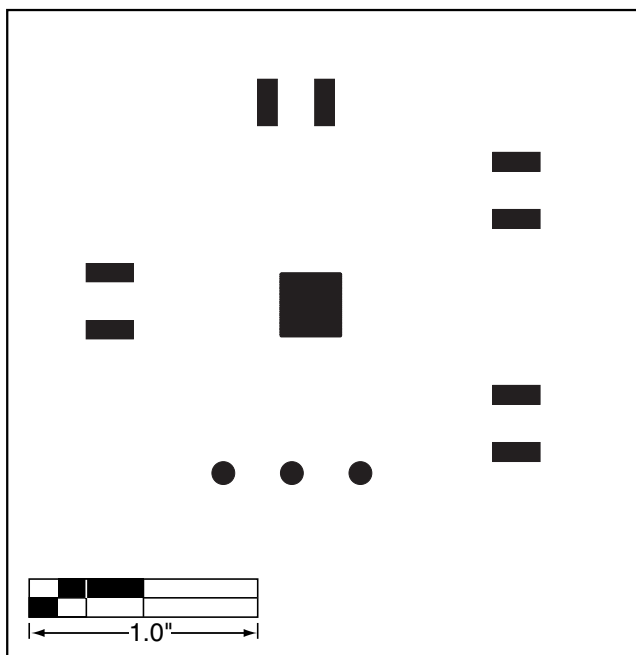

Figure 9. MAX9993 EV Kit PC Board Layout—Bottom Soldermask

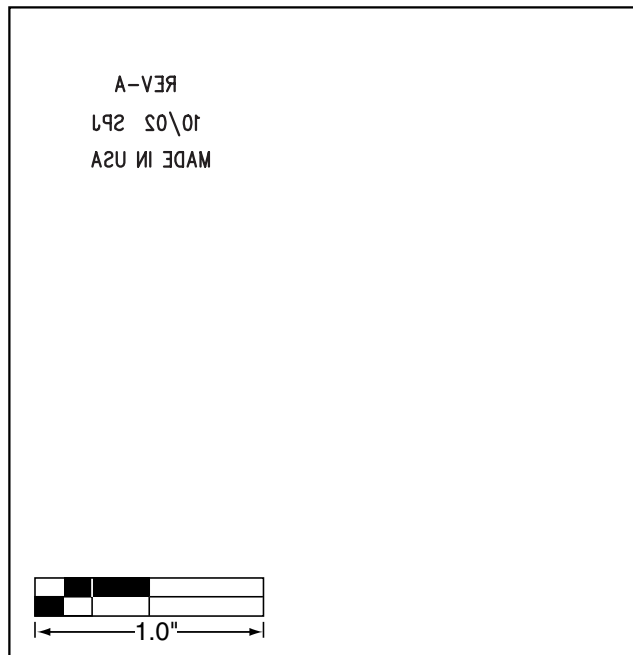

Figure 10. MAX9993 EV Kit PC Board Layout—Bottom Silkscreen

Maxim cannot assume responsibility for use of any circuitry other than circuitry entirely embodied in a Maxim product. No circuit patent licenses are implied. Maxim reserves the right to change the circuitry and specifications without notice at any time.

Maxim Integrated Products, 120 San Gabriel Drive, Sunnyvale, CA 94086 408-737-7600 _____ 7